

Library of
The MIT
Library





Digitized by the Internet Archive
in 2007 with funding from
Microsoft Corporation

The Journal of
American History

9951/3



1061-4-18





The Journal of
American History

Relating Life Stories of Men and
Events that have entered into the
Building of the Western Continent

REPRODUCTIONS FROM RARE
PRINTS AND WORKS OF ART
(AMERICANA)

127039
4/4/13

Original Researches into Authoritative Sources—American, British and
European Archives—Private Journals, Diaries and Hitherto
Unpublished Documents—Fugitive Papers—
Reminiscences and Memoirs—
Folklore and Traditions

Associated Publishers of American Records

Produced by the Associated Publishers of American Records, Inc.
 in the Ancient Municipality of New Haven, Commonwealth of Con-
 necticut, in Quarterly Art Editions, four books to the volume
 at Two Dollars annually, Fifty Cents a copy & Compiled
 in Collaboration with the Connecticut Magazine
 Protected by copyright and Printed from press
 of the Borman Lithographing Company
 Application made for entry at Post
 Office at New Haven as mail
 matter of the second class
 Nineteen Hundred
 and Seven



E
 171
 J86
 v.1

Foreign

Three dollars annually & Seventy-five cents a copy

LONDON	W. Wesley & Son 28 Essex Street, Strand, W. C.	ROME	L. Piale 1 Piazza di Spagna
PARIS	Brentano's 37, Avenue de l'Opera	ST. PETERSBURG	Watkins and Company Markala No. 36
BERLIN	Asher and Company Unter den Linden 56	CAIRO	F. Diemer Shepherd's Building
DUBLIN	Combridge and Company Grafton Street	BOMBAY	Thacker and Company Limited Esplanade Road
EDINBURGH	Andrew Elliott 17 Princess Street	TOKIO	Methodist Publishing House 2 Shichome, Giz Ginza
MADRID	Libreria de Romo y Fassell Calle Alcalá, 5	MEXICO CITY	American Book Printing Co. 1st San Francisco No. 12

Syllabus of the Inaugural Number

FIRST VOLUME

FIRST NUMBER

Collecting the Various Phases of History, Art, Literature,
Science, Industry, and Such as Pertains to the Moral, Intellectual
and Political Uplift of the American Nation—Inspiring Nobility
of Home and State—Testimonial of the Marked Individuality
and Strong Character of the Builders of the American Republic

HERALDIC ILLUMINATION—Coat-of-arms in use by the Hooker Family in America as descendants of Thomas Hooker, emigrant in 1633, and author of the First Written Constitution in the World, creating a government—Emblazoned in six colors by.....	Charles L. N. Camp	
AMERICAN FLAG—THE EMBLEM OF LIBERTY—Story of Its Evolution from the Discovery of the New World to the Present Age when the Sun Never Sets on the Stars and Stripes—Accompanied by a Silk Memorial Flag made by the Cheney Mills at South Manchester, Connecticut, and seven Silk Tissue reproductions in Original Colors.....	Mrs. Henry Champion	9
TO THE AMERICAN PEOPLE—THE VOICE OF THE STATES—Expressed in Personal Messages from the Governors to "The Journal of American History"		
"America's Greatest Need is Civic Virtue".....	Honorable George E. Chamberlain Governor of Oregon	17
"Higher Standards of Public Service".....	Hon. George R. Carter, Governor of Hawaii	18
"Future Mastery of the Pacific Ocean".....	Hon. George C. Pardee Governor of California	21
"An Inspiration for Worthy Work".....	Hon. Fred M. Warner, Governor of Michigan	23
"Strong, New Blood Elevates Citizenship".....	Hon. Bryant B. Brooks Governor of Wyoming	24
"The Native Honesty of the Nation".....	Hon. John C. Cutler, Governor of Utah	25
"American in Spirit and in Aspiration".....	Hon. Andrew L. Harris, Governor of Ohio	26
"Wholesome Immigration is a Builder".....	Hon. J. O. Davidson, Governor of Wisconsin	27
"Commercialism Must Not Dominate America".....	Hon. Joseph M. Terrell Governor of Georgia	29
"The Spirit of Patriotism Still Lives".....	Hon. Wm. T. Cobb, Governor of Maine	31
THE "MIRACLE" OF THE FIRST STEAMBOAT—Tragedy of an American Genius who was Publicly Ridiculed as a "Fanatic" for Proposing the Propulsion of Vessels by Steam against Wind and Tide—The Idea was Pronounced "Impracticable" and to Risk Life in its Undertaking "Foolhardy"—Eleven Reproductions from Rare Prints.....	By Seymour Bullock	33
MEMOIRS OF A SOUTHERN CONGRESSMAN—Ranging the Borderlands with Daniel Boone—Encounters with the Cherokees in Command of the Light Dragoons—Electioneering in American Politics a Hundred Years Ago—On the Floor of Congress during the Monroe Administration—Old Manuscript left. By Hon. Felix Walker	Born in Virginia in 1753	49
A WEDDING SUIT IN 1756—Transcribed from Ancient Memorandum	By Fannie M. Hackett, Biddeford, Maine	60
PERSONAL LETTERS OF PIONEER AMERICANS—Glimpses into Time-stained and almost Indecipherable Correspondence Revealing the Strong Character, Conscientious Lives, Business Integrity and Hardihood of the First Citizens of the Republic		61
Letter Sent by Post-boy from William Prentiss, during the Plague in Philadelphia, to Dr. Jeremiah Barker, Fallmouth, Casco Bay, Massachusetts, in 1793—Transcribed from Original.....	By Abbie F. Carpenter, Portland, Maine	61
Letter Written to Reverend Chandler Robbins of Plymouth, Massachusetts, by Reverend Little in Birmingham, England, Discussing the Moral Problems in 1797—Transcribed from Original.....	By Mrs. Lydia J. Knowles, Bangor, Maine	62
Letter Sent by George Washington, in 1797, to Honorable Oliver Ellsworth, a Frammer of the Constitution, Minister to France, and Chief Justice of the United States—Transcribed from Original.....	By Adaline B. Ellsworth Roberts Ollana, Illinois	63
THE CENTENARY OF AN AMERICAN POET—Henry Wadsworth Longfellow—Born at Portland, Maine, February 27, 1807—Died at Cambridge, Massachusetts, March 24, 1882—Four Sonnets inscribed to His Memory and Centennial Bas Relief	By Louis A. Gudebrod, National Society of Sculpture	64
PHILOSOPHY OF DEATH IN EARLY AMERICA—Manuscript by the Reverend Joseph Webb, Born in 1666, and an Intellectual and Moral Leader of His Times—Occa-		

INDEX CONTINUED (OVER)

Context with Engravings and Authors

FIRST QUARTER

NINETEEN SEVEN

Chronicles of Those Who Have Done a Good Day's Work—
Rich in Information upon Which May Be Based Accurate
Economic and Sociologic Studies and of Eminent Value to
Private and Public Libraries—Beautified by Reproductions of
Ancient Subjects through the Modern Processes of American Art

CONTINUATION OF INDEX

stoned by the Demise of Major Nathan Gold, in 1693, who was Foremost in Political, Military and Ecclesiastical Affairs—Original Sermon Transcribed	
By Mrs. Elizabeth Hubbell Schenck, Washington, District of Columbia	65
ANECDOTE OF AN AMERICAN REVOLUTIONIST	By Mrs. J. R. Cozart
	Lamar, Arkansas
LIFE STORIES OF GALLANT AMERICANS.....	72
John Moor—The Knight of Derryfield—Contributed. By Mrs. Lina Moore McKenney	73
	Madison, Maine
James Caldwell—Hero of Elizabethtown—Contributed. By Mrs. Hiram Price Dillon	73
	Topeka, Kansas
AN OLD TAVERN SONG—Transcript from Fugitive Paper.....	76
ESTATE OF A "WELL-TO-DO" AMERICAN IN 1689—Transcribed	79
	By M. Augusta Holman, Leominster, Massachusetts
CENTENARY OF GENERAL ROBERT E. LEE—His Last Portrait taken on His Old War Horse "Traveller"—Excerpt from Theodore Roosevelt's Writing by His Special Permission.....	80
	Supplement
ADVENTURES OF AN AMERICAN SEAMAN—Journal of Captain Samuel Hoyt, Born in 1744, and Followed the Roving Life of His Generation—On a Fighting Ship off Havana, Cuba, in 1762—Experiences as a Prisoner on a Privateer—Wanderings as a Fugitive along the American Coast—Contributed.....	81
	By Julius Walter Pease
	In His Ninety-Third Year
ONE OF THE FIRST INSTANCES OF BOYCOTT IN AMERICA—Transcript from Original Document.....	88
	By Ella S. Duncan, Keokuk, Iowa
EXPERIENCES IN EARLY WARS IN AMERICA—Life Story of an Ambitious American Youth who at Sixteen Years of Age was Fired with the Spirit of Patriotism and against the Will of his Parents Marched to the Battle Line in Defense of His Country—Original Journal of Peter Pond, Born in 1740—Transcribed	89
	By Mrs. Nathan Gillette Pond, an Eminent Genealogist
✓ BILL OF SALE OF A NORTHERN SLAVE IN 1721—Transcribed from Original	94
	By Eliza Comstock, Descendant of Slave-Holder
✓ QUAIN WILL OF A NEGRO SLAVE IN 1773—Transcribed from Original	95
	By Eliza Comstock
A MOTHER'S LETTER TO HER SON IN 1789—Transcribed from Original in Possession of.....	96
	Joseph Alsop, Descendant of Correspondent
PIONEER LIFE ON AMERICAN FRONTIER—Experiences of a Federal Justice on the Trail of the Prairie Schooners—Carrying the Law into the Western Wilderness—Treaties with the Indians and the Establishment of Courts in a New Land of Gold and silver—The Birth of the Rich West—Several illustrations bearing the lines "Old Prints in Possession of Judge Munson" should be credited to Hon. William Henry Milburn's work "In the Valley of the Mississippi." Judge Munson wishes it fully understood that these illustrations are from Mr. Milburn's original work, a copy of which was presented to a member of his family by the author. The work is published by the N. D. Thompson Publishing Company of New York and St. Louis and should be read by all who are interested in American pioneer life.	97
	Judge Lyman E. Munson
	United States District Court of Montana in 1865
THE FIRST AMERICAN SOLDIERS—Call "To Arms" began with Arrival of First White Men in the New World—Footmen with Musket and Pike—Horsemen with Pistol and Carbine—Military Force Blazed Path for Civilization—Heroic "Trained Bands" and the Organization of the Continental Army... By Hon. Spencer P. Mead	120
	Of the New York Bar
WHEN SORROW BECKONS AT THY DOOR—A Poem.....	128
	Howard Arnold Walter
	Now in the Orient
COUNTRY LIFE IN AMERICA—Six Nature Reproductions.....	129
Path Through the Wood—Drawing by Daniel F. Wentworth.....	130
Moonlight—Drawing by Daniel F. Wentworth.....	131
The Road Home—Sun Gravure by George C. Atwell.....	132
The Old Mill—Sun Gravure by George C. Atwell.....	133
The Meadows—Drawing by Daniel F. Wentworth.....	134
The Brook—Sun Gravure by George C. Atwell.....	134

Transcripts From Ancient Documents

JANUARY

FEBRUARY

MARCH

A "Journal of American History" will be a Credit to the Nation. I hold its builders in High Esteem. I cannot too strongly Endorse the Plan. I am sure it will receive the Immediate Cooperation of All who have the Real Interests of the Nation at heart—
HENRY ROBERTS, Governor of Connecticut

CONCLUSION OF INDEX

THE ACADEMY OF AMERICAN IMMORTALS—The Hall of Fame.....	135
Bronze Medallion of George Washington, First President of United States.....	136
Bronze Medallion of Abraham Lincoln—First Great American Liberator.....	137
Bronze Medallion of Daniel Webster, First Great American Statesman.....	138
Bronze Medallion of Benjamin Franklin, First Great American Diplomat.....	139
CONTEMPORARY AMERICAN POETRY—An Ode to Niagara Falls—With Four Photo Art Engravings.....	141
By Hon. Henry Taylor Blake, Now in His Seventy-Ninth Year	
FIRST AMERICAN'S GREETING TO THE WHITE MAN—Sculpture	
By Herman Atkins McNeil, National Society of Sculpture	144
HERE LET ME DWELL—A Poem.....	145
By Frederic E. Snow, B.D.	
LETTERS OF A SERGEANT IN WAR OF 1812—Romance of John Burt, First Battalion Artillery, and Persis Meacham—With Transcripts from Correspondence and two Ancient Silhouettes.....	147
By William Burt Harlow, Ph.D., Now in the Bermudas	
FIRST CHAMPION OF UNIVERSAL PEACE—Memories and Anecdotes of Ellhu Burritt, an American Farmer-lad who Rose from a Blacksmith Forge and Through Self-instruction Acquired the Tongues of Fifty Nations—He Appealed to Christendom to Cease Warfare and Became Honored by the Master Minds of the Old World—With Prophecy of Victor Hugo and Last Portrait of Ellhu Burritt	
By Hon. David Nelson Camp, M.A., Department of Education at Washington in 1867	151
ANCIENT AMERICAN LANDMARKS—Two Photo-Engravings.....	162
SCULPTURE IN AMERICA—The First Sculptors and Their Hardships in the New World—With two Reproductions from Early Sculpture.....	163
By Bickford Cooper	
I WHO HAVE DRUNK THE WATER BITTER SWEET—A Sonnet..	166
By Horace Holley	
BEGINNINGS OF AMERICAN ARCHITECTURE—Six Photo-Engravings of Ancient Structures.....	167
PAINTING IN AMERICA—The First Artists and Their Experiences on the Western Continent—With three Reproductions from Rare Paintings.....	169
By Stuart Copley	
MUSIC IN AMERICA—The Struggles of the First Composers against Public Condemnation.....	173
By Clara Emerson	
IMMUTABILITY—An Illustrated Poem.....	175
By Frank Burnham Bagley	
BOOK-LOVERS OF 1738—ONE OF THE FIRST LIBRARIES IN AMERICA—The Literary Inclinations of Early Americans—The Books They Read and Their Learned Discussions in Matters Intellectual and Moral—A Treatise on "Physick" was the Foundation of Literary Culture in the Discriminating Judgments of these First American Bibliophiles—with Portrait of the First Librarian of the Philogrammatican Library.....	177
By Mrs. Martha Williams Hooker	
Great-Granddaughter of the Founder	
CONTEMPORARY THOUGHT IN AMERICA—"The Press of the Republic is the Moulder of Public Opinion—the Leader and Educator".....	186
American Municipalities of the Future...By T. E. Stafford in "Daily Oklahoman"	
Progress is Adjusting the Race Problem.....By Frank Johnston	186
In Jackson (Mississippi) "Evening News"	
Marriage and Divorce are Subject to Evolution.....By J. W. Spear	187
In Arizona "Republican"	
Will American Republic Outgrow State Lines?.....By Gilbert D. Paine	187
In Memphis (Tennessee) "News Scimitar"	
American Constitution is in Advance of Times.....By Horatio W. Seymour	188
In Chicago, (Illinois) "Chronicle"	
Shall America Limit Private Fortunes?.....By W. H. Merrell	188
In Boston (Massachusetts) "Herald"	
American Purpose is Common Good.....Editorial Writer in New York "Tribune"	189
America Must Save Lives of Its Children	
Editorial Writer in Houston (Texas) "Chronicle"	189
America Extends Freedom to all Religions	
Editorial Writer in Montgomery (Alabama) "Advertiser"	190
Conquest for Pacific Must Not Come	
Editorial Writer in Philadelphia (Pennsylvania) "Inquirer"	190
Americans—Our Future Civilization—Excerpt from Recent Public Utterance	
By Theodore Roosevelt, President of the United States, Cover	



**THE STAR-SPANGLED BANNER IN TRIUMPH SHALL WAVE
O'ER THE LAND OF THE FREE AND THE HOME OF THE BRAVE**

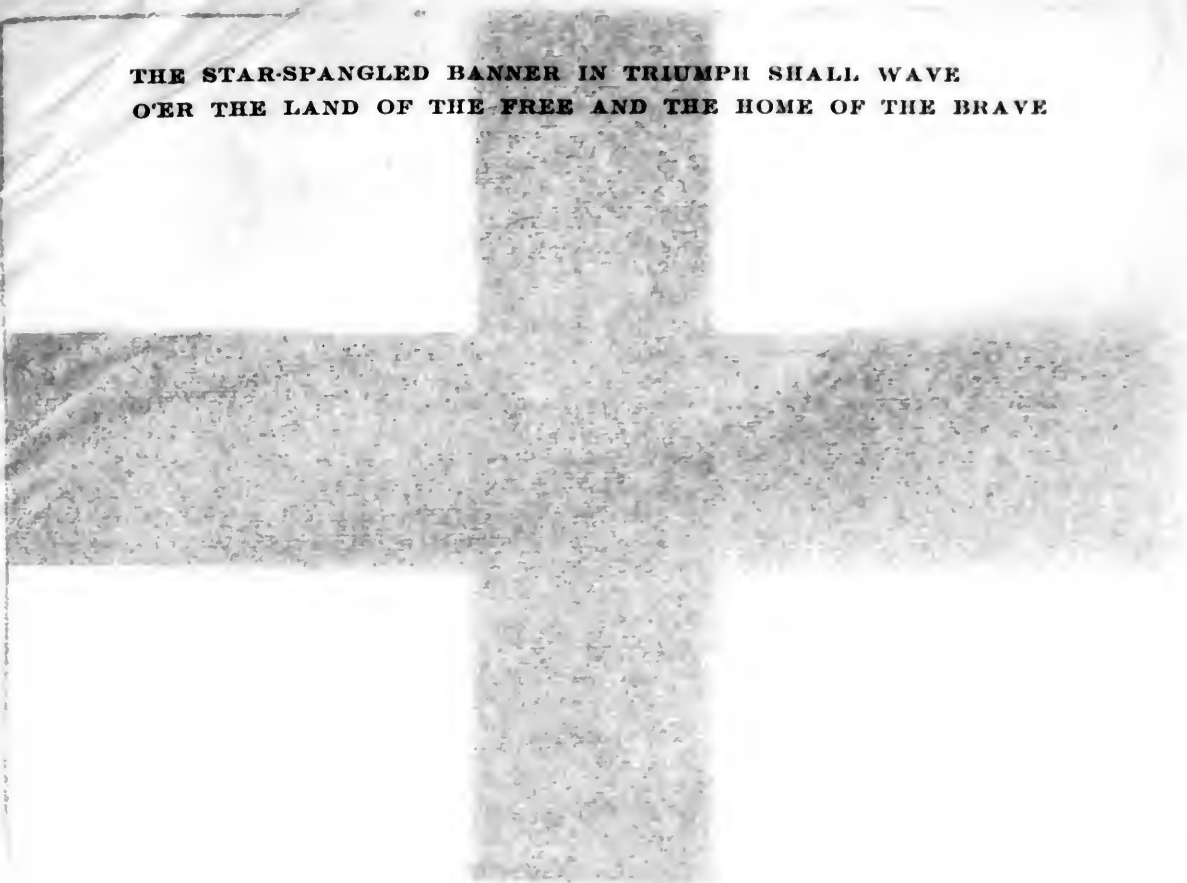

82

O'ER THE LAND OF THE FREE AND THE HOME OF THE BRAVE
THE STAR-SPANGL'D BANNER IN TRIUMPH SHALL WAVE



It is a... the American... Nations un...

It has... the... the...

with the unwieldy... might the... the...

It has created the... the... the... the...

**FIRST FLAG
TO FLOAT OVER
NORTH AMERICAN SOIL.**

**"RED CROSS OF ST. GEORGE." THE BANNER OF
RICHARD CORUR DE LION IN 1192 AND
PLANTED AT LABRADOR BY SEBASTIAN
CABOT IN 1497, AS THE ROYAL EN-
SIGN OF HENRY THE SEVENTH**

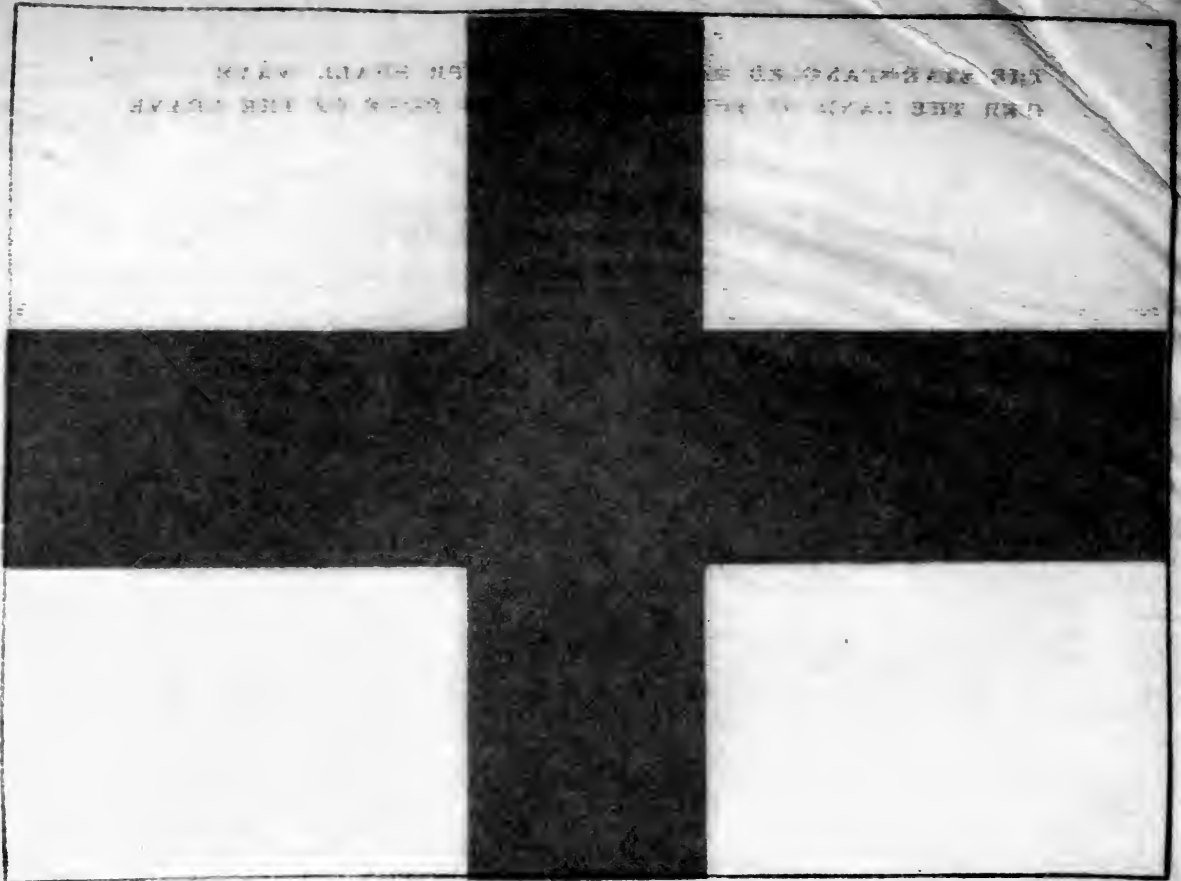

NORTH AMERICAN SOIL
TO FLOAT OVER
FIRST FLAG

SIGN OF HENRY THE SEVENTH
GAVE IN 1197 AS THE ROYAL EN-
PLANTED AT LABRADOR BY SEBASTIAN
RICHARD COEUR DE LION IN 1192 AND
"RED CROSS OF ST. GEORGE," THE BANNER OF

The Journal of American History



VOLUME I
NINETEEN SEVEN

EDITED BY FRANCIS TREVELYAN MILLER

NUMBER I
FIRST QUARTER

American Flag—The Ensign of Liberty

The Sun Never Sets on the Stars and Stripes

BY

MRS. HENRY CHAMPION

AUTHOR OF THE BROCHURE "OUR FLAG"

Revised for this publication and copyright assigned to the author

THE sun never sets on the American flag! The triumphant proclamation of the British Empire that night never mantles her domain is now the exultation of the American people. The Lion has its compeer!

It is but two generations ago that the American Nation, like a black knight, entered the tournament of the Nations unarmored and unskilled with the unwieldy commercial lance.

Well might the Old World look upon it as brazen effrontery. Impoverished by the War for Independence and facing a financial crisis more serious than any of its experiences on the battlefield, the knight of the west looked to the east for the loan of sufficient funds to secure the bare sustenance of life—but without sympathy.

The aged monarchies proclaimed it a hazardous risk and forecasted short life to the bold knight, pronouncing self-government as the vision of irresponsible theorists.

The tournament of the Nations has been swift. From thirteen scattered states in the wilderness the American Republic has swept from ocean to ocean. It has pushed the light of liberty to the far ice-bounds of Alaska. With a leap it has carried the dawn of a new day into the Hawaiian Islands and into the Philippines; it has extended its arm to struggling Cuba and Porto Rico as the champion of freedom, until to-day the American knight holds the commercial supremacy of the world, and with a wealth estimated at one-tenth of a trillion dollars, and increasing at the rate of twelve millions a day, it is the richest Nation on earth—in Men and gold.

American Flag—The Ensign of Liberty

OUR flag, whose one hundred and thirtieth birthday we celebrate this June 14, 1907, was, like everything in nature or history, a *growth*, and to trace that growth takes us back to the National flag of the Mother Country.

One naturally asks, what flag floated over the early settlements of our country? What over its battle-fields previous to that June day in 1777, when by an act of Congress it was resolved "that the flag of the nation be thirteen stripes, alternate red and white, and thirteen stars, white on a blue field?"

Answering our question in order of time, we take first the earliest settlements of the country.

Tradition tells us that the Norsemen, or Northmen, and the Danes landed between the years 986 and 1300 at several points at the extreme northeast of the continent, and even as far down the coast as the New England shore.

Tradition also relates that an expedition from Iceland in 1347 landed near what is now Newport, Rhode Island—at which time the "Round Tower" was built. These expeditions no doubt planted some ensign or standard, as they took temporary possession, but no record of its design is left us.

In 1492, Columbus planted the Spanish flag on the Island of San Salvador, one of the Bahama group, and again in 1498 at the mouth of the Orinoco, South America. He supposed he had then reached the coast of Asia. According to Humboldt, Sebastian Cabot landed at Labrador in 1497, and planted the "Red Cross of St. George," the royal ensign of Henry the Seventh. If so, the English flag then for the first time floated over North American soil. But we narrow down our field of inquiry to what is now the United States and as we remember that for one hundred and sixty-nine years from the settlement

of Jamestown, Virginia, or the one hundred and fifty-seven years, from the wintry day when the Mayflower landed at Plymouth Rock, to the June day in 1777 when the stars and stripes were adopted—for this more than a century and a half the flag of England was our flag, we ask with interest, what was the flag of the Mother Country in those years?

About the year 1192, Richard Cœur de Lion had asked the aid of St. George, Bishop of Cappadocia. He gave the king as a banner what is now called the "Red Cross of St. George," and Edward III, about 1345, made St. George the patron saint of the kingdom.

Under this flag Sir Humphrey Gilbert, Bartholomew Gosnold and others sailed with grants of land from Queen Elizabeth to found colonies in the new world, 1578-1587.

The generous, even reckless way, in which land was disposed of by these charters is shown by the boundaries given.

All the land between the latitude of Cape Fear, North Carolina, and Canada was given by the Queen and to be called "Virginia." It was to be divided into two districts; the southern part, from the latitude of Cape Fear to the mouth of the Potomac, and running back indefinitely into the wilderness, was given to the "London Company," and to be called Southern Virginia; the land from about the latitude of New York to Canada was given to the "Plymouth Company," and to be called Northern Virginia.

The strip of country between these two grants, about one hundred miles of coast, was to be a dividing line to avoid disputes as to territory, and neither company might make settlements more than fifty miles from its boundary.

All these efforts to plant colonies proved failures. Lack of supplies and cold winters led the settlers to give up the project and return to England.

This "Red Cross of St. George"



**FIRST FLAG
TO FLOAT OVER
PERMANENT SETTLEMENTS IN AMERICA**

"THE KING'S COLORS" A UNION BETWEEN THE RED
CROSS OF ST. GEORGE OF ENGLAND AND THE
WHITE CROSS OF SCOTLAND UNDER KING
JAMES I IN 1606 - THE FLAG OF
THE MAYFLOWER IN 1620

102

American Flag—The Ensign of Liberty

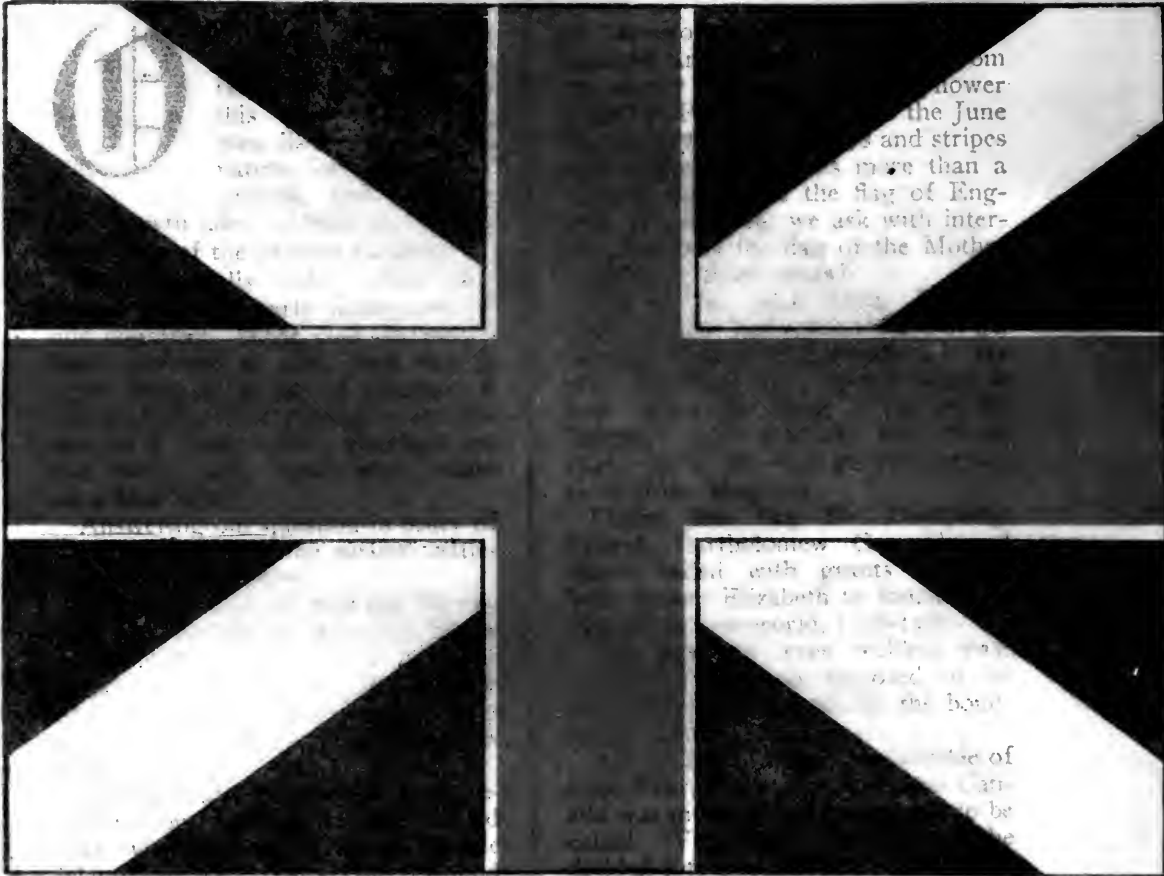

In 1492, Columbus planted the parish line on the Island of San Salvador, one of the Bahama group, and again in 1498 at the mouth of the Orinoco South America. He supposed he had then reached the coast of Asia. According to Humboldt, Sebastian Cabot landed at Labrador in 1497 and planted the "Red Cross of St. George," the royal ensign of Henry the Seventh. If so, the English flag then for the first time floated over American soil. But we narrow down our field to inquiry into the United States that for centuries from the

part, from the latitude of Cape Fear to the mouth of the Potomac, and a narrow strip definitely into the wilderness was given to the "London Company" and to be called Southern Virginia, and from about the latitude of New York to Canada was given to the "Plymouth Company," and to be called Northern Virginia.

The strip of country between these two grants, about one hundred miles of coast, was to be a dividing line to avoid disputes as to territory, and neither company might make settlements more than fifty miles from its boundary.

All these efforts to plant colonies proved failures. The "King's Colors" a Union between the "Cross of St. George of England" and the "White Cross of Scotland" James I. in 1606—the

THE MAYFLOWER IN 1620

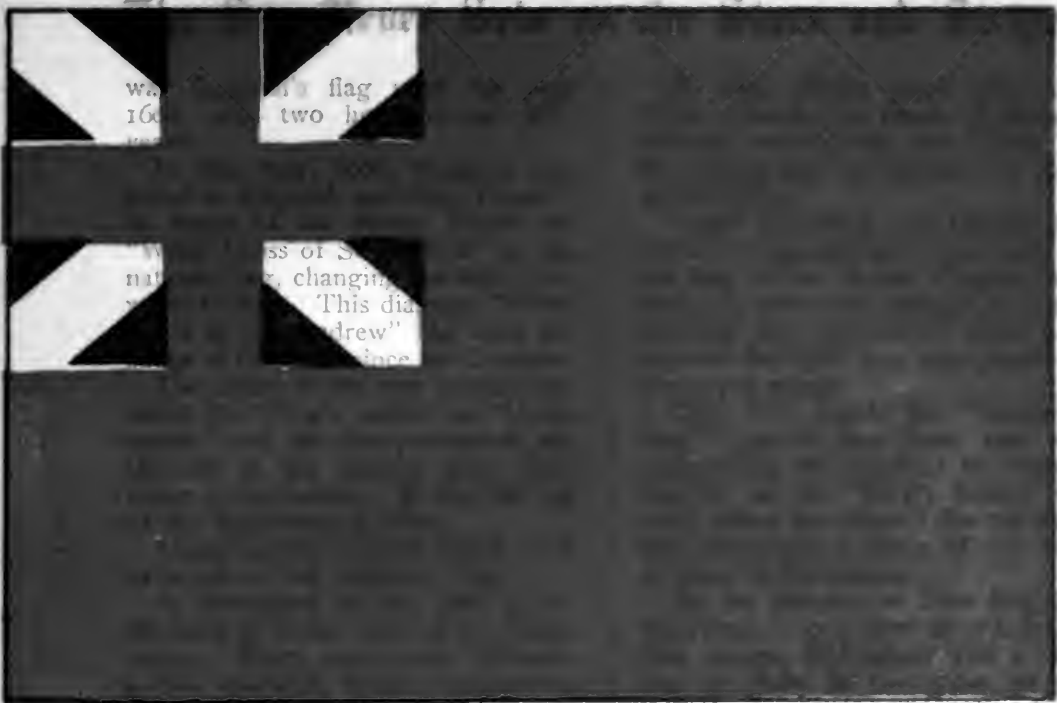

w.
160

's flag
two h

nat

ss of S
changing
"This dia
drew"
page

... England, but the red cross was a relic
of the old flag, having been given to
Holland by a queen, and it was a
mark of alliance. After revisiting the
subject in an assembly of ministers,
and after in vain consulting with their
British relations, the States finally allowed
the flag to be changed.

... which was the origin of the
... of which the American flag is
... at the entrance of the harbor
... King's colour, that is, the
... This was done, to the extent of show-
ing them on the staff at the

... a vessel was placed in the harbor
and they were not used elsewhere in
the colony. This was in 1639.

In 1643, the three colonies of Ply-
mouth, Massachusetts and Connecti-
cut united, under the name of the
United Colonies of New England,
but no flag was adopted.

**THE FLAG OF
CROMWELL AND CHARLES II
UNITE THE COLONIES IN THE NEW
WORLD AND WAS THE CAUSE
OF MUCH DISSENSION.**

ABOUT 1707

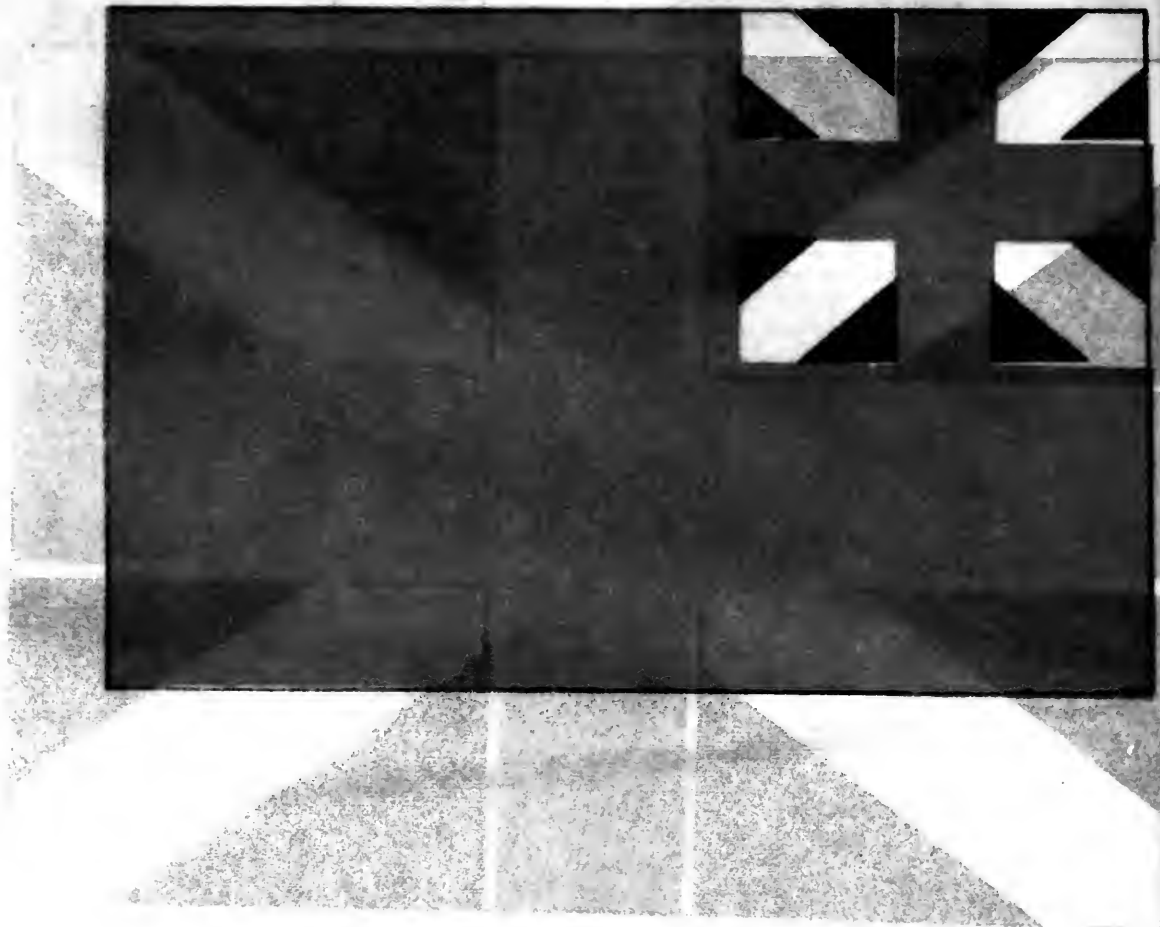

ABOUT 1707
OF SUCH DISSENSION
WORLD AND WAS THE CAUSE
UNITED COLONIES IN THE NEW
THIS FLAG WAS NOT ACCEPTED BY THE
CROMWELL AND CHARLES II
THE FLAG OF
FIRST 1707

The Sun Never Sets on the Stars and Stripes

was England's flag until the year 1606, over two hundred and fifty years.

In that year, 1606, Scotland was added to England, and King James I, in honor of the union, placed the "White Cross of St. Andrew" on the national flag, changing the field from white to blue. This diagonal "White Cross of St. Andrew" had been the badge of the Scots since the Crusades.

The union of the two crosses was called the "King's colors," or "Union colors," and the first permanent settlements in this country were made under its protection. It was the flag of the Mayflower in 1620.

Massachusetts records speak of it as in use in that colony in 1634.

In November of that year a Mr. Endicott of Salem defaced the King's colors. Much excitement followed, a trial was held, when it was proven that it was not done with ill-intent to England, but the red cross was a relic of anti-Christ, having been given to England by a pope, and so was a cause of offense. After referring the matter to an assembly of ministers, and then to one court after another, it was proposed that the colony show no flag, and none was displayed.

Then arose a question. If captains of vessels returning to Europe were asked what colors they saw here, the truth might cause trouble. The matter was referred to Reverend John Cotton, who wisely suggested a way by which the growing spirit of independence might be satisfied and yet no offense be given. He said, "As the fort at the entrance of Boston harbor without doubt belongs to the King, the 'King's colors' should be used *there*." This was done, to the extent of showing them on the staff at the fort when a vessel was passing, but *only* then, and they were not used elsewhere in the colony. This was in 1636.

In 1643, the three colonies of Plymouth, Massachusetts and Connecticut united, under the name of "The United Colonies of New England," but no flag was adopted.

In 1651, fifteen years after the Salem episode, the Court of Massachusetts *ordered* that the "Cross of St. George and St. Andrew" be used in the colony.

Under Cromwell and Charles II, various minor changes were made in the flag of the Mother Country, but later the color was changed to crimson and the two crosses, which had covered the entire flag, were placed in the upper corner.

This was called the "Cromwell flag," and in that form was not accepted by the colonies; we continued to use the "King's Colors" till 1707, when we adopted the red flag, but substituted a device of our own in place of the crosses.

All the pictures of New England flags from 1707 to 1776 show a red or blue ensign, field white, with a pine tree or globe in the upper corner, sometimes covering the entire field. The pine tree was oftener used.

Massachusetts had used the pine tree as her symbol for some time. It is on the silver coins of that colony, the die for which was cast in 1652, and used without change of date for thirty years. Trumbull, in his celebrated picture of the "Battle of Bunker Hill," in the rotunda of the Capitol at Washington, represents the red flag, white corner, green pine tree.

The Connecticut troops who took part in the exciting times that followed Lexington and Bunker Hill had a state banner with the state arms and the motto, "*Qui transtulit sustinet*."

The troops of Massachusetts adopted the words, "An Appeal to Heaven."

Early New York records speak of different standards; indeed, the regiments from various states, hastening to the aid of Washington or his generals, carried flags of various devices; many having only a local interest and only used on the occasion that originated them.

The men at Lexington had neither uniform nor flags, but at Bunker Hill,

American Flag—The Ensign of Liberty

two months later, the Colonial troops had more the appearance of an army.

Among the flags described, the pine tree is most frequently mentioned, also a serpent coiled, ready to spring, with the motto, "Beware!" "Don't tread on me," or "Come if you dare!" The snake flag was used by the Southern states from 1776, to June, 1777. A chain of thirteen links, a ring, a tiger, and a field of wheat were also used as devices.

In October, 1775, Washington writes to two officers who were about to take command of cruisers: "Please fix on some flag, by which our vessels may know each other."

They decided on the "pine-tree flag," as it was called. This is frequently mentioned in the records of 1775 and 1776 as used by vessels.

The first *striped* flag was flung to the breeze and "kissed by the free air of Heaven," at Cambridge, Massachusetts, Washington's headquarters, January 1, 1776.

Washington says: "We hoisted the Union flag in compliment to the United Colonies, and saluted it with thirteen guns."

It had thirteen stripes, alternate red and white, and the united crosses of St. George and St. Andrew on a blue field. Similar flags were used later in the year.

When reported in England, it was alluded to as "the thirteen rebellious stripes."

In 1775 a navy of seventeen vessels, varying from ten to thirty-two guns, was ordered. Says Lieutenant Preble: "The senior of the five first lieutenants of the new Continental Navy was John Paul Jones. He has left it on record that the 'Flag of America' was hoisted by his own hand on his vessel, the 'Alfred,' the first time it was ever displayed by a man-of-war." This was probably the same design as the Cambridge flag, used January 1, 1776, and was raised on the "Alfred" about the same time. No exact date is given.

We come now to the time when the

crosses of St. George and St. Andrew were taken from the striped Union flag, and a blue field with white stars was substituted for the symbol of English authority.

Thirteen states had bound themselves together as the "United States of America." They were:

New Hampshire,	Pennsylvania,
Massachusetts,	Delaware,
Rhode Island,	Maryland,
Connecticut,	Virginia,
New York,	North Carolina,
New Jersey,	South Carolina,
	and Georgia.

One hundred and thirty years ago this June fourteenth, 1907, the American Congress in session at Philadelphia resolved, "that the flag of the thirteen United States be thirteen stripes, alternate red and white; the union to be thirteen stars, white on a blue field, representing a new constellation, the stars to be arranged in a circle."

Here we may ask, what suggested the "Stars and Stripes?"

It has been said in answer, that the words "representing a new constellation" refer to the constellation Lyra, symbol of harmony; that this suggested the *stars*. As to the stripes, some writers refer us to the stripe which, in the absence of uniform, marked the rank of Continental soldier, by orders from headquarters at Cambridge, July 24, 1775.

Says another writer, in answer: "The flag of the Netherlands." It had become familiar to the Puritans during their twelve-years' sojourn in Holland, and its triple stripe, red, white and blue, suggested the stripes and the three colors.

Another answer has been, that Washington found in the coat of arms of his own family a hint from which he drew the design for the flag.

The coat of arms of the Washington family has two red bars on a white ground, and three gilt stars above the top bar. A careful search among the records of that family

The Sun Never Sets on the Stars and Stripes

fails to discover any connection. Says one of their genealogists: "There are several points of resemblance between our coat of arms and the flag of the country." The three stars are explained as meaning in heraldry that the estate passed to the third son.

In an English genealogy of the family, the author refers to the matter as entirely without foundation, and adds: "At this time Washington was only commander-in-chief of the army, and Congress arranged the flag; besides, he was not at all popular, then, there being a strong movement to supplant him with Sir Horatio Gates, fresh from the victory of Saratoga."

Certainly, Washington himself never referred to any connection between his coat of arms and the flag, and his pride of family might have led him to do so, had any connection existed.

It has seemed to me, from a careful study of the subject, that to no one thing, but to a blending of several, especially of several flags, are we indebted for the design of our own.

It is said that a committee had been appointed, three weeks before the June fourteenth when the stars and stripes were adopted, who were to consider the subject and report on a general standard for all the troops of the colonies; that the committee, consisting of General Washington, Robert Morris and Colonel Ross, called on Betsy Ross, widow of John Ross, who kept an upholsterer's shop on Arch street, Philadelphia, and passing into the back parlor to avoid public view they asked Mrs. Ross if she could make a flag after a design they showed her. She said she would try. She suggested changing the stars that Washington had drawn with six points, the English rule, to five points, the French rule. Her suggestion was accepted. Our flags always have the five-pointed stars, our coin the six-pointed. There is no doubt but that Betsy Ross made the first flag and that she made them for

the government for several years. There is an entry of a draft on the United States Treasury, May, 1777: "Pay Betsey Ross £14, 12s. 2 d. for flags for fleet in Delaware river."

It is claimed that the first *using* of the stars and stripes in actual military service was at Fort Stanwix, renamed Fort Schuyler, now Rome, New York, in 1777. August third, of that year, the fort was besieged by the English and Indians; the brave garrison were without a flag, but one was made in the fort. The red was strips of a petticoat furnished by a woman, the white was from shirts torn up for the purpose, and the blue was a piece of Colonel Peter Gansevoort's military cloak. The siege was raised August 22, 1777.

The first anniversary of American independence was celebrated July 4, 1777, at Philadelphia, at Charleston, South Carolina, and other places.

Records of the exercises are preserved, and the flag adopted a few weeks earlier is mentioned as used.

Thirteen stripes and thirteen stars are mentioned as used at Brandywine, September 11, 1777, at Germantown, October 4, 1777, and to have floated over the surrender of Burgoyne.

This flag cheered the patriots at Valley Forge the next winter, it waved at Yorktown, and shared in the rejoicings at the close of the war.

The shipping of the country seems to have been slow to adopt any particular form of flag.

In 1789, when Washington took the presidential chair for his first term, there were thirteen states in the Union, none having been added in the twelve years since 1776, nor were any added till Vermont came into the Union, two years later in 1791, and Kentucky in 1792. In consequence of these additions the Senate in Congress passed a bill, in 1794, increasing the number of stars and stripes to fifteen, to take effect the next year, 1795. When the bill came to the House it caused considerable debate. Said one wise prophet, "The flag

American Flag—The Ensign of Liberty

ought to be permanent; we may go on altering it for one hundred years. Very likely in fifteen years we may number twenty states." This was almost literally fulfilled.

One representative suggested that "it might give offense to incoming states, if a new star and a new stripe were *not* added." The bill finally passed, making fifteen the number of stars and of stripes after July 4, 1795. We used the fifteen-striped flag for twenty-three years. But one after another the states came knocking for admission.

Tennessee, 1796; Louisiana, 1812; Ohio, 1802, and Indiana, 1816, had joined the Union, and in 1816 the subject of the flag came up again in Congress, now assembled at Washington; since 1800 the capitol of the country. It is of interest to note that the capitol of the country was changed nine times during the Revolutionary War.

A committee was appointed (1816) to inquire into the expediency of again altering the flag. This committee reported in favor of increasing the number of stars and of stripes to twenty, the number of states then (1817) in the Union, Mississippi being admitted that year. The matter was referred to Captain S. C. Reid, who as captain of a privateer had made himself famous by the capture of several British ships. He advised reducing the number of stripes to the original thirteen and increasing the number of stars, one for each incoming state, making them form one large star, the motto to be, "*E pluribus unum*." The committee reported the bill as recommended by Captain Reid.

It was "laid over," came up again and was passed April 4, 1818, to take effect July fourth of that year. The new star did not take its place on the field of the flag till the July fourth following the passage of the bill. A newspaper of the day says: "The time allowed for the change, three months, is too short. It will take a month before the change can be re-

ported in New Orleans and vessels all over the world cannot hear of it for a year or more."

Mrs. Reid made the first flag after the new design, proposed by her husband. July 4, 1818, the number of stars in the flag was twenty.

The rule of arranging the stars to form one large star was abandoned. As the number of states increased, was necessary to make the individual stars on the field so small as to be almost indistinguishable as stars, or their points must interlace. The plan of arranging them in rows was adopted in 1818 and has been continued.

Illinois was admitted in 1818.

Alabama in 1819.

Maine, 1820.

Missouri, 1821.

Arkansas, 1836.

Michigan, 1837.

Florida, 1845.

Texas, 1845.

Iowa, 1846.

Wisconsin, 1848.

California, 1850.

Minnesota, 1858.

Oregon, 1859.

Kansas, 1861.

West Virginia, 1863.

Nevada, 1864.

Nebraska, 1867.

Colorado, 1876.

North and South Dakota, 1889.

Montana, 1889.

Washington, 1889.

Idaho, 1890.

Wyoming, 1890.

Utah, 1896, the forty-fifth state and star. Since that date, every Congress has had before it a bill for the admission of one or more territories, but it has failed to pass both Houses. The last Congress had a bill to unite Oklahoma and Indian Territory and Arizona and New Mexico. The former passed (1906) but a State constitution is yet to be adopted by the people and approved by Congress, so its star, the forty-sixth, will probably take its place on the field of the flag, July 4, 1907. By vote of Congress the question of joint

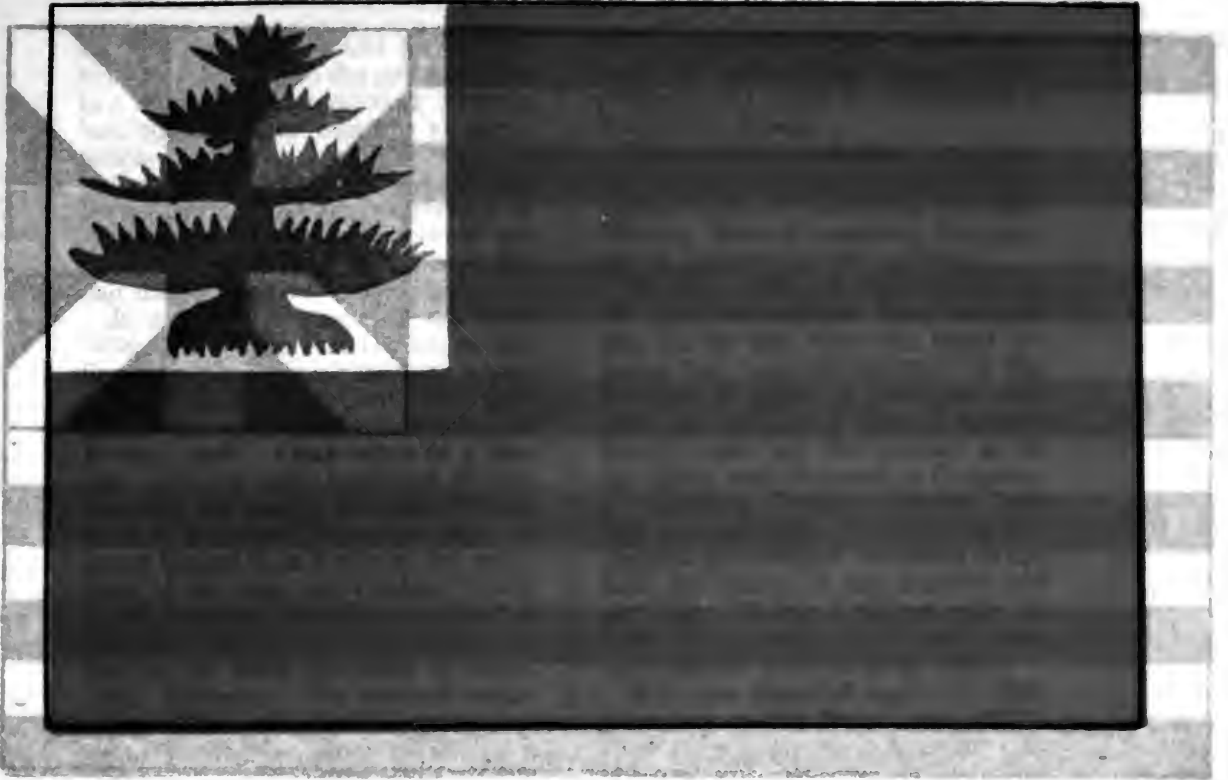

**FIRST FLAG
OF COLONIAL SECESSION**

**A REVOLUTIONARY BANNER KNOWN AS
THE "PINE TREE FLAG" AND FLOWN
TO THE BREEZE DURING THE
AT WAS REVOLUTIONARY YEARS**

**DESIGNED FROM 1707 TO 1776
AND A LITTLE MORE IN THE
THE THIRTEEN STATES**

The Sun Never Sets on the Stars and Stripes

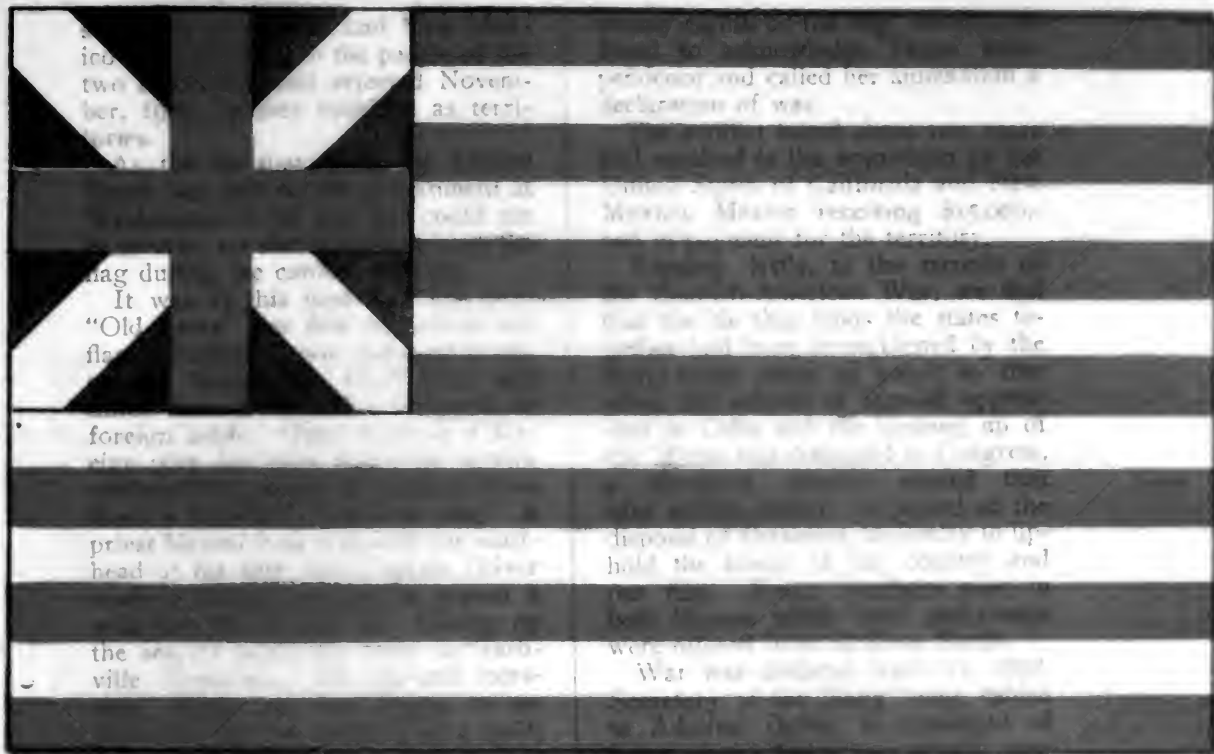

fore
pr
the
ville

November
declaration of war
Mexico, Mexico receiving 30,000
the states
War was declared
War was declared

FIRST FLAG OF AMERICAN INDEPENDENCE

In 1845, the
tically free
from Mexico
annexed to the
was received.

HOISTED WITH A SALUTE OF THIRTEEN GUNS
AT WASHINGTON'S HEADQUARTERS IN CAM-
BRIDGE, MASSACHUSETTS, JANUARY 1, 1776,
AND ALLUDED TO IN OLD ENGLAND AS
"THE THIRTEEN REBELLIOUS STRIPES"

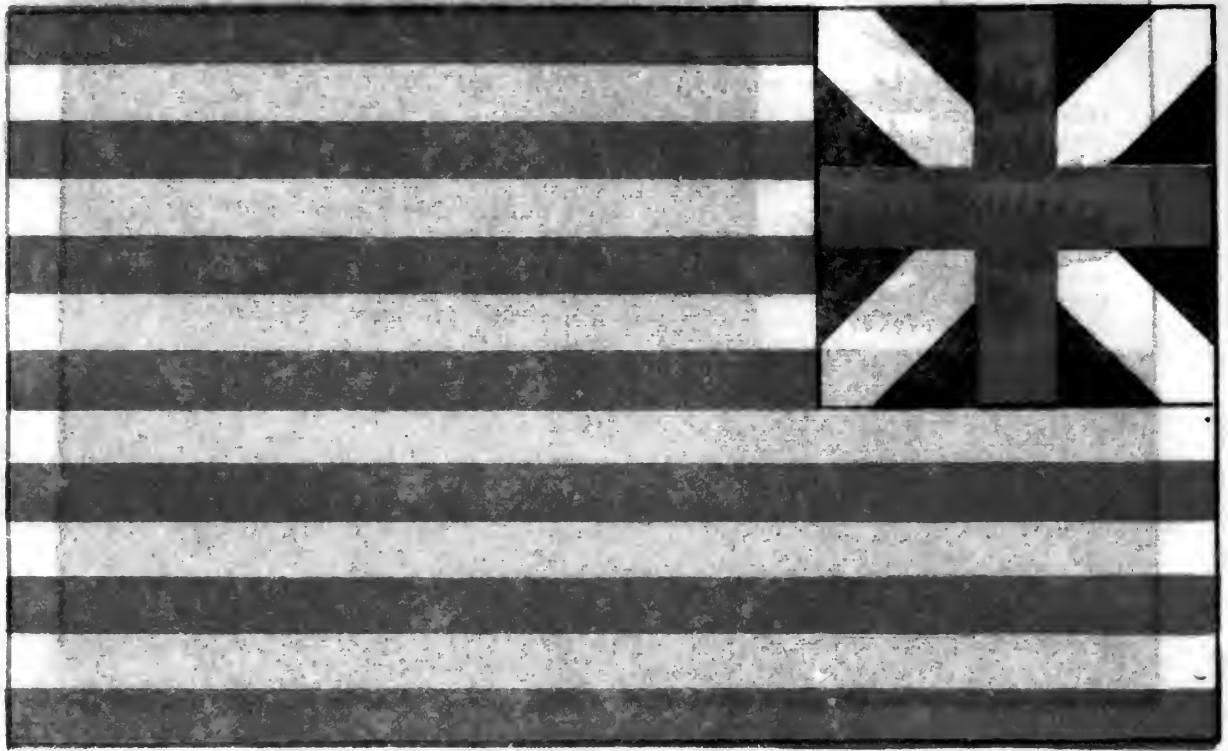

"THE THIRTEEN REBELLIOUS STRIPES"
AND ALLUDED TO IN OLD ENGLAND AS
BRIDGE, MASSACHUSETTS, JANUARY 1, 1776.
AT WASHINGTON'S HEADQUARTERS IN CAMP
HOISTED WITH A SALUTE OF THIRTEEN GUNS
THE "FIRST THREE STRIPES" AND FLOWNS
A REVOLUTIONARY BANNER BECAME THE
OF AMERICAN INDEPENDENCE
FIRST FLAG
OF CONTINENTAL CONGRESS
FIRST FLAG

The Sun Never Sets on the Stars and Stripes

statehood of Arizona and New Mexico was submitted to the people of the two territories, and rejected November, 1906, so they continue as territories.

As the tie that binds the United States was held by the government at Washington to be one that could not be severed, no star was taken from the flag during the conflict 1861-65.

It was at this time that the term "Old Glory" was first applied to our flag. Stephen Driver had been a sea-captain before the Civil War and sailed from Salem, Massachusetts, to foreign lands. Once when in a foreign port, for some important service rendered the people, he received from them a beautiful American flag. A priest blessed it as it rose to the mast-head of his ship, and Captain Driver made a solemn promise to defend it with his life if need be. Giving up the sea, he made his home in Nashville, Tennessee. He opposed secession. When the war began, to secrete the flag he sewed it in a quilt, and every night slept beneath it. *He named it Old Glory.*

Since that eventful afternoon of July 4, 1776, when with a boldness that seemed an audacity and a hope that seemed a prophecy, the name United States of America was added to the list of independent nations, and nearly a year later, June 14, 1777, the stars and stripes adopted as the sign of nationality, we have been one of the combatants in three wars: with England, 1812-15; Mexico, 1846-48, and the Spanish-American War, 1898.

The first was largely fought in Northern New York and on the lakes. Our small navy was uniformly successful; "more than nineteen hundred British vessels were captured." Not once was our flag of fifteen stars and fifteen stripes lowered in token of surrender.

In 1845, Texas, that had been practically free for many years, seceded from Mexico and formally asked to be annexed to the United States. She was received, her star making the

twenty-eighth on the flag. Mexico refused to acknowledge Texas' independence and called her annexation a declaration of war.

The conflict lasted about two years and resulted in the acquisition by the United States of California and New Mexico, Mexico receiving \$15,000,000 in payment for the territory.

Turning, lastly, to the records of the Spanish-American War, we find that the tie that binds the states together had been strengthened by the thirty-three years of peace so that when the subject of Spanish oppression in Cuba and the blowing up of the Maine was discussed in Congress, a Southern Senator moved that fifty million dollars be placed at the disposal of President McKinley to uphold the honor of our country and our flag. Every Southern man in both Houses voted "aye" and troops were offered from all those States.

War was declared April 21, 1898. Secretary of the Navy Long, cabled to Admiral Dewey in command of seven of our finest war vessels composing the Pacific squadron, to capture or destroy the Spanish fleet in the harbor of Manila. The battle was fought May 1, beginning at 5:20 A. M., the stars and stripes flying from every mast-head. In seven hours and a half every Spanish ship was destroyed, while not one of our fleet was badly injured.

Secretary Long, as soon as the news reached him, ordered the "Oregon," the largest and newest of our fleet, to join the Atlantic squadron off Cuba "with all speed." Raising the "homeward-bound flag" to the mast-head, Captain Clark started on his 14,000 mile race round Cape Horn. This flag is a long streamer, about one-third of its length is blue, with the stars in line; the rest of the flag is a parallel strip of white with one of red. It is raised at the mast-head when the war-vessel starts and flies there during the voyage. It is sometimes a hundred feet long and would dip into the water if lying at rest. Obeying;

American Flag—The Ensign of Liberty

orders, steam was kept up to the highest point night and day, but so perfect had been the construction of the vessel, that not once was the steam pressure lessened for repairs and in less than four weeks, May twenty-fourth, the "Oregon" anchored off Cuba.

June first a watch was set off the harbor of Santiago where Admiral Cervera's fleet had been discovered hiding. This was ascertained by balloon. Our vessels formed a semi-circle with steam up and search-lights at night. June second the "Merrimac" was sunk at the entrance to the harbor. Lieutenant Hobson wished the vessel to go down flying the stars and stripes, but the admiral refused, saying the flag would be a target for the Spanish guns in the fort at the entrance to the harbor. Sunday morning, July third, Admiral Cervera, watching an opportunity to escape, saw a flag mount to the mast-head of the flag-ship "New York," the only flag that ever flies above the stars and stripes. He recognized it as the church flag and knew that divine service was being held and the men off duty. This flag is raised as the service begins and lowered at its close; it is a pennant of white, nearly square, deeply notched and bearing a Greek cross of blue.

Cervera ordered "Forward!" but the lookout saw the line of smoke moving behind the hills that shut in the harbor and firing a signal-gun to attract attention, signalled "they are coming." In three minutes every man was at his post at the guns or in the powder-room in his Sunday suit of white duck.

This was at 9:30. At 1:30 every Spanish ship was burned or beached. The Spanish colors were lowered at 11:00 in surrender to our flag. The rapidity with which these two great naval battles were fought attracted the attention of all nations. It is of interest to note, that we entered this war the sixth of the naval powers of the world; we stood the second at its close.

Porto Rico asked to be taken under our protection and our flag was raised

on the palace at Poncé, October 18, 1898.

It may be of interest to refer to one more change made in the flag of England in 1801. In that year Ireland became a part of the kingdom, and to commemorate that event, the "Cross of St. Patrick," a red diagonal, was by order of King George III fimbriated (to use a heraldry phrase) on the "Cross of St. Andrew." By a heraldry law the flag of Scotland shows uppermost in the first and third quarter of the field and that of Ireland in the second and fourth.

As this third cross was added in 1801, England's flag in its present form was never used by an American colony.

As we have seen, the principal change in our flag since its adoption, June 14, 1777, has been in the gradual increase of the number of stars. In its general form it is older than any of those of Europe, except Denmark, which has been in use since 1219. Ours is followed by Spain, 1785.

Thirty-one states and three territories have what is called a "flag law," making it a misdemeanor punishable with fine or imprisonment or both, to place any picture or inscription on the flag of the country. The number of the United States regiment is excepted. There is a bill before Congress to make a National law to that effect.

The Aleutian Islands, a part of Alaska, extend so far to the westward that when it is sunset on the most westerly part, it is sunrise in Eastport, Maine. So it is that since 1867, thirty-five years before the Philippine Islands were taken under our care "for the purpose of protection and government" we can make the proud boast that the sun never sets on the American flag.

Great is our wealth, great is our domain—but greater than these, and of more importance than all of them is our intellectual and moral advance, our conscientious citizenship, our love of home and country—the dominant cord in American life.

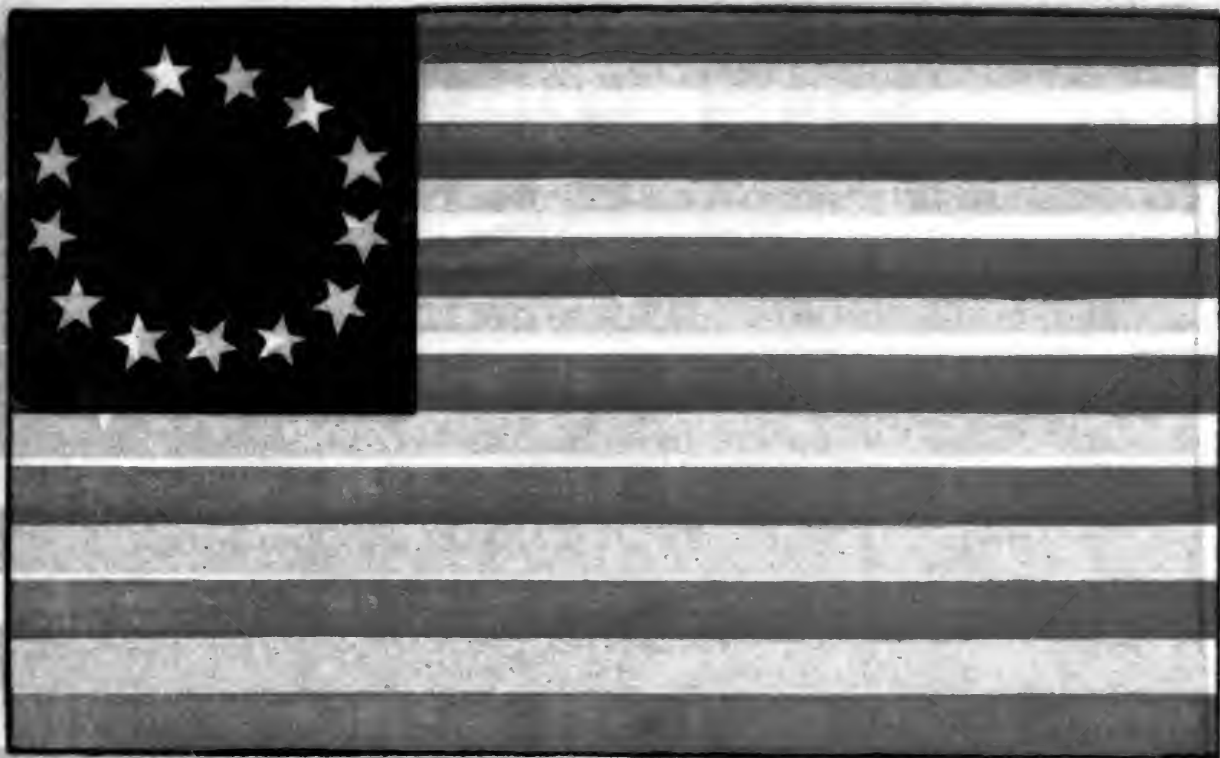

**FIRST FLAG
OF THE AMERICAN REPUBLIC**

ADOPTED BY AMERICAN CONGRESS IN
PHILADELPHIA, JUNE 14, 1777. WITH
THIRTEEN STARS AND THIRTEEN
STRIPES SYMBOLIZING THE THIR-
TEEN ORIGINAL COLONIES

16^a
11^b

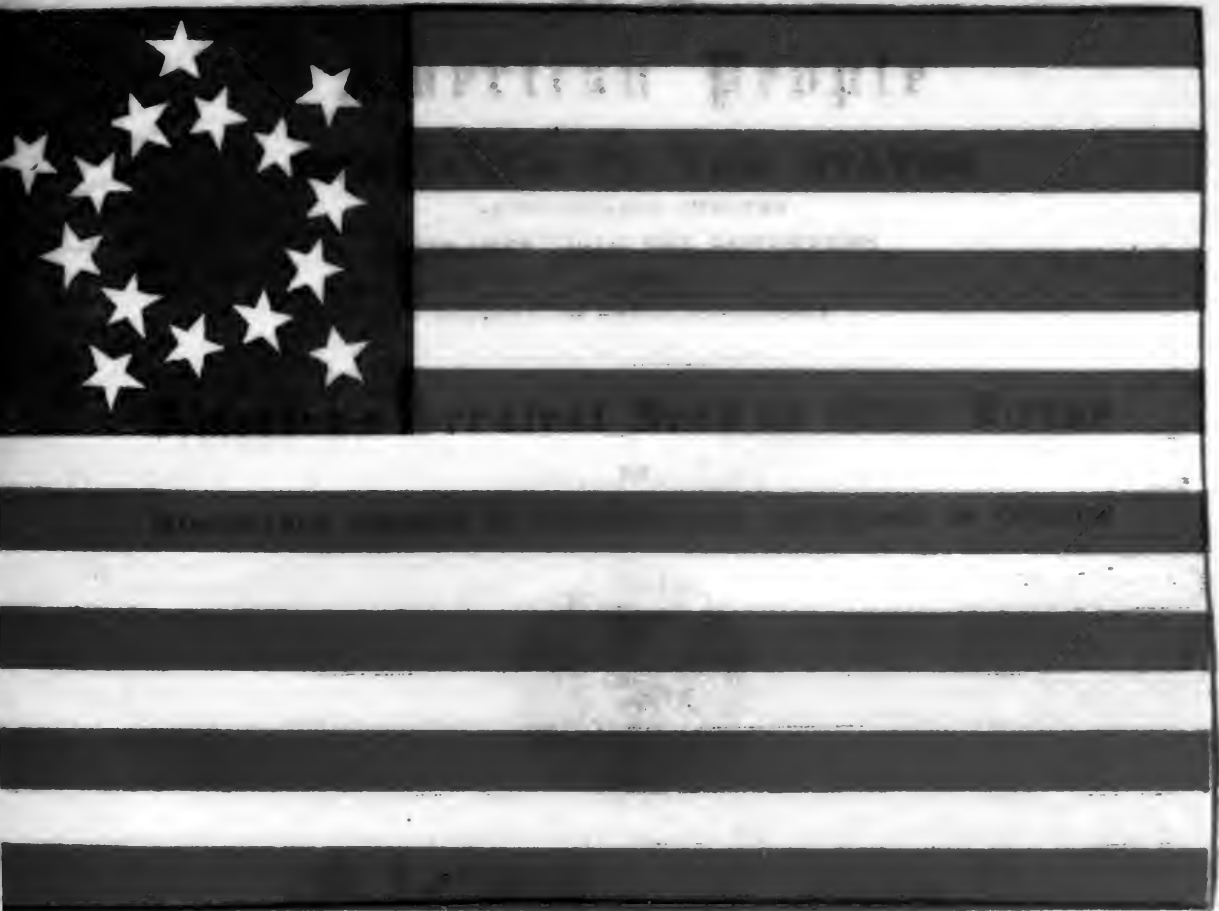

A

will be the
great aggression
country and
cause of their
continually
law.

**FIRST FLAG
OF AMERICAN EXPANSION**

I do not believe
waning.
growing
brighter with

that our country is
**UNITED STATES CONGRESS UPON THE ADMISSION
OF TWO MORE STATES TO THE AMERICAN
UNION ADDED TWO MORE STARS TO**

16^h

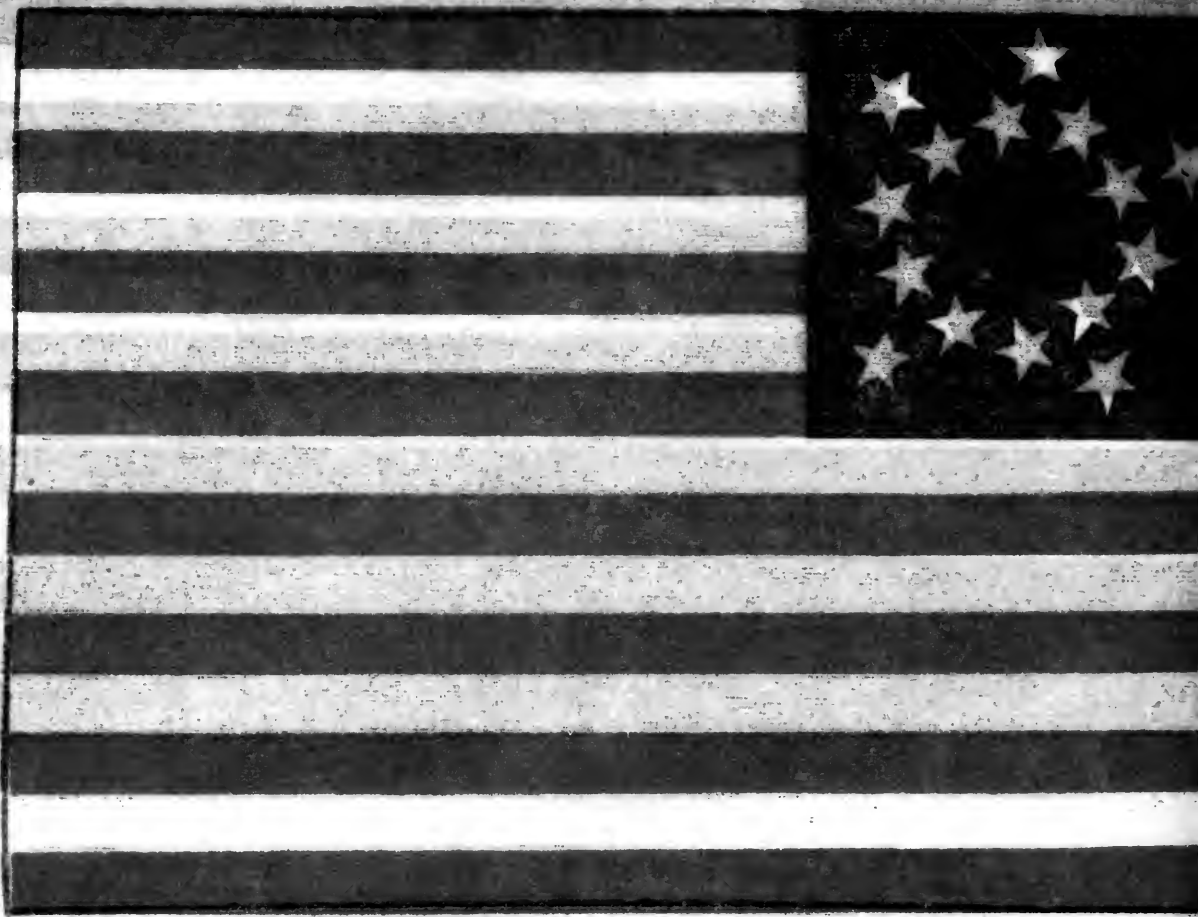

THE FLAG ON JULY 4, 1792
UNION ADDED TWO MORE STATES TO
OF TWO MORE STATES TO THE AMERICAN
UNITED STATES CONGRESS UPON THE ADMISSION
OF TWO MORE STATES TO THE AMERICAN
CONGRESS IN 1792

OF AMERICAN EXPANSION
FIRST FLAG
ON THE AMERICAN REPUBLIC
FIRST FLAG

To the
American People

THE VOICE OF THE STATES

AS EXPRESSED THROUGH
MESSAGES FROM THE GOVERNORS
TO THE
JOURNAL OF AMERICAN HISTORY

America's Greatest Need is Civic Virtue

BY

HONORABLE GEORGE E. CHAMBERLAIN, GOVERNOR OF OREGON



Geo E Chamberlain

AMERICA'S greatest need is more of civic virtue, an aroused public conscience, and the election of men to office unpurchased, unpurchasable, and who are willing to regulate and control the great aggregations of wealth in this country and punish those who, because of their wealth and influence continually disobey and disregard the law.

I do not believe that patriotism is waning. I believe that our country is growing better and its prospects brighter with the passing years.

Oregon's greatest need to-day is more transcontinental railways, with a rigid law authorizing the regulation of transcontinental and other rates.

The first settlement in Oregon was made at Fort Clatsop near the mouth of the Columbia River, on the twenty-third day of March, 1811. The settlers were composed of men who came around from New York on board the ship Tonquin, which was fitted out by John Jacob Astor of New York for the fur trade of the Pacific Coast.

Oregon was admitted to the Union on the fourteenth day of February, 1859.

America's Greatest Need is Civic Virtue

It is probable that Honorable E. D. Baker, who left his position in the United States Senate as senator from Oregon to take command of a regiment in the Civil War, and who was killed at Ball's Bluff in Virginia, was one of the best known men of the State, but there were others equally as able and who would probably have been as illustrious if their fates had been as tragic, and amongst the number I would mention Honorable Delazon Smith, Honorable J. W. Nesmith, Honorable Joseph Lane, the latter of whom participated in the Mexican War with distinction and later was a prominent factor in State and National politics.

Our population to-day is about five hundred and fifty thousand.

Our greatest wealth-producing product is lumber, but Oregon is soon to take the first rank as a great agricultural State. Our greatest revenues are derived from these two industries.

Quite a number of immigrants are coming here, principally from the Middle West and from the East, and I would say that the majority of them

are American-born, though there are some Italians and a good many of the Scandinavian races. Generally they seek occupation in the country and are thrifty.

The immigration to which I refer has no particular effect on the citizenship of the State. Our citizenship has always been of a high standard and it is being maintained by an excellent class of immigrants.

There is no trouble between labor and capital in this State, and there never has been any serious trouble.

Oregon is forging ahead in all lines and is developing more rapidly than ever before in its history.

Corporal punishment in the schools is rare, though it has never been abolished, it has never been abused. Nor has capital punishment been abolished. I hope the day is not near at hand when either will be abolished, so far as I am personally concerned, and do not agree with the sentiment which declares itself in favor of sparing the rod and spoiling the child, nor which does not take kindly to the old Mosaic law.

Higher Standards of Public Service

BY

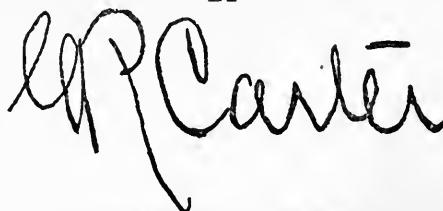

GOVERNOR OF HAWAII

AMERICA'S greatest need is to follow the Golden Rule and practice what she preaches—admit that all men are born equal and permit any human being to become a citizen of our great Republic, irrespective of race or color, whenever he

possesses reasonable qualifications which justify the assumption that he will be patriotic and loyal to the Union.

Patriotism is increasing and we are reaching higher standards of public service under the splendid examples of Roosevelt, Root and Taft.

Message from Hawaii by Governor Carter

The traditions and legends of the Hawaiian people show that the Islands were settled many centuries prior to their discovery on the eighth of December, 1777, by Captain Cook. After his death, various adventurers in search of trade touched at these Islands, and it is impossible to state when the first European or foreigner settled in the Islands. The salubrity of the climate and the charm of the Islands early caused runaway sailors to remain on them, and the narratives of a number of these have been published.

In 1791, Captain Kendrick, of Boston, left three sailors on Kauai to collect sandal-wood, pending his return.

In March, 1792, Vancouver made his first visit, which, from his great interest and kindly advice and the fairness with which he treated the natives, did much towards their elevation and advancement.

The sandal-wood trade brought the Hawaiians into contact with the Orient, and the knowledge gained from there was used by Kamehameha I in bringing the entire group under his dominion, which was completed about the year 1810.

The harbor of Honolulu was discovered by Captain Brown, of the schooner "Jackal," in 1794, and named by him "Fair Haven." The facilities it offered for commerce and trade brought about a considerable settlement on the neighboring shores and the port of Honolulu developed rapidly.

The turning point in the history of the Islands was the arrival of the pioneer missionaries on October 23, 1819, who had been sent out by the American Board of Missions on the brig "Thaddeus," Captain Blanchard, and of which Mr. James Hunnewell, of Boston, was first officer. Kamehameha I had died May 8, 1819, and his son being still in his minority, divided the sovereignty with Kaahumanu, his guardian. The missionaries finally secured permission from

them to settle. A large proportion of these and the later additions, with their descendants, have remained permanently on the Islands.

Hawaii is not a State, nor is it a dependency of the United States, as are Porto Rico and the Philippines. The Hawaiian Islands were annexed by joint resolution of Congress, approved by President McKinley on July 7, 1898. This information reached here and the ceremony by which the American flag was raised took place on August 12, 1898. Then followed a transition period, during which the former Hawaiian laws were continued and the Islands were governed by direct executive order of the president of the United States until June 14, 1900, on which date went into effect the *Act of Congress organizing Hawaii into a Territory*, approved by the president on April thirtieth previous. By this act, Hawaii became an integral part of the Union, in many respects the form of government granting greater power to the people and centering larger authority here (due undoubtedly to our geographical isolation) than had theretofore been granted by Congress in organizing any territory.

The time which has elapsed since Hawaii entered the Union has been so short that we must go beyond that to ascertain what great men or great events have developed in Hawaii in its relations to the United States.

General Armstrong, the founder of Hampton Institute, was an Hawaiian boy, one of a number of young men of American parentage whose patriotism caused them to volunteer from Hawaii in the service of the Union during the Civil War. In his early boyhood he had observed the workings of a manual training-school in the town of Hilo, started by the early missionaries. His father was for many years Commissioner of Education in Hawaii, instituted compulsory education, and laid the foundations of common school education here, mod-

Message from Hawaii by Governor Carter

eled, of course, upon the American common school system, but in some respects in advance of it. It was natural, therefore, for young Armstrong to be interested in educational questions, and his life-work resulted in the development of Hampton Institute and its practical ideas of education, now so ably extended by Booker Washington and Tuskegee.

Probably no other event better illustrates the attitude of the people of the Hawaiian Islands towards the United States of America than one which occurred during the war with Spain. When the question arose in Hawaii, an independent nation, as to what its attitude should be towards the combatants, it was Hawaii's privilege to remain neutral, in which case her ports could only harbor the vessels of the warring nations for twenty-four hours and furnish coal in amount sufficient to reach the next home port. Although unarmed and unprotected, and under the impression that Spanish men-of-war were cruising in the South Pacific waters, yet President Dole took no action until he had ascertained whether the course he contemplated would in any way embarrass the United States. If not, it was his desire and that of the people of Hawaii to abandon neutrality and announce to the world that they were to be classed as favoring the United States, would harbor her troops and vessels, and abide the consequences of such a course.

The census of 1900 showed the population of the Hawaiian Islands to be some 155,000, largely engaged in agriculture.

Agriculture predominates, sugar, coffee and pineapples being the principal products, with sisal and rubber forging ahead. There are also the usual business and commercial pursuits found in cities.

The supply of labor is entirely inadequate, and the first lot of European immigrants to be landed under the auspices of the Territorial Board

of Immigration has just arrived. These came from the Azores and a large percentage of them have gone to work on the sugar plantations. They are a thrifty and very desirable class of people.

From past experience, it is believed that this immigration will have a very beneficial effect on the citizenship of Hawaii, increasing the number of those who can accept civic duties.

The problem of capital and labor is not so perplexing in Hawaii as it is on the mainland. The outcome is bound to be satisfactory if, as in our case, those who control corporations are dominated by humane impulses. From my observation, the corporations in Hawaii come nearer to having "souls" than any others I know of.

Hawaii appears to be forging ahead in its great work of making known to one another the habits, customs and qualities of the peoples of the Orient and Occident—a common meeting-ground for both. Our schools resemble retorts, into which all kinds of raw material are poured, and we believe the resultant out-put will be patriotic and loyal American citizens. We also believe that if the Golden Rule and the broad principles upon which our Union was founded are maintained in spirit and practice here, that these little Islands will show to the mainland that the causes of a "yellow peril" exist only among our own people.

In our public schools corporal punishment is rarely resorted to. We find it is not necessary. Capital punishment is in operation. Our murder trials are not, as a rule, as expensive to the taxpayers or as sensational as in other communities. I believe I am expressing the sober sentiment of this community when I state that the effect and result justify capital punishment.

Hawaii's greatest need is a larger population of self-reliant, sturdy citizens.

Future Mastery of the Pacific Ocean

BY HONORABLE GEORGE C. PARDEE, GOVERNOR OF CALIFORNIA



Geo. C. Pardee

DURING the last five years more settlers have come into California than for any similar period since the gold rush. They come from all parts of the United States and from other countries. To a very large extent these settlers buy lands and become farmers, but they also distribute themselves through all lines of industries. The pleasant winter climate draws many thousands of tourists to California every year, and many of these persons remain and build homes. Large accessions to the wealth and population of many towns, especially in the southern portion of the State, have been made in this way.

The greater portion of the immigration is of a high order and benefi-

cial to the State, but recently there has been a considerable influx of Japanese, who are gaining a foothold in both town and country and promise to become an industrial force of importance. This fact is regretted by most citizens. In San Francisco and a few other cities the problem created by the contending forces of labor and capital is serious, as it is in great centers of population elsewhere, and it can only be solved by a gradual process of evolution along conservative lines.

At the present time California is progressing in a most satisfactory manner, especially in everything which tends to a higher civilization. No State spends money more liberally upon the public schools; indeed,

Message from California by Governor Pardee

more than fifty per cent of the revenues of the State, now about \$10,000,000 per annum, are expended for education. The University of California, a free institution supported by the State, has in its various colleges more than three thousand students, while Leland Stanford, Junior, University, has about half as many.

At the present time California has a population of more than two millions. Their industries are diversified, for while agricultural and horticultural pursuits engage the attention of the largest numbers of persons, California has usually been about tenth among the States in order of importance in manufacturing business. Mining, the earliest industry, is still being conducted with great success, fifty or more mineral substances being produced on a commercial scale. In the production of petroleum California now leads all the other States. There are more than twenty million acres of valuable forest and lumbering is conducted on a large scale. The horticultural products of California far exceed in value those of any other State.

I will say that although corporal punishment in the schools has not been abolished, it is reduced to a minimum. Our laws still recognize capital punishment for murder, but it is within the option of trial juries to fix the punishment at life imprisonment, and this is very generally done. Capital punishment will very probably become obsolete some day, but it is very questionable whether the time has yet come to prohibit it. In my judgment, the greatest need of California as of every other State is good citizenship—good, better, best citizenship. I do not believe that patriotism, in the truest sense, is waning in California or in any other commonwealth made up of educated men and women. On the contrary, the love of country never manifested itself in a more discriminating and elevated form than at the present time.

The first settlements by civilized men in California were made by the Franciscan friars from Mexico, who followed in the wake of Cabrillo, Viscaino and other explorers of the sixteenth century. A great work of exploration and of peaceful conquest was performed by these earnest priests, who established a chain of missions extending from the extreme south to the region immediately north of the Bay of San Francisco and taught and civilized the Indian population.

The first mission was established in San Diego in 1769, and within a little more than half a century twenty other missions were established, each becoming a center of industry and culture. The Government of Mexico, not very much later, began colonizing Upper California and established a system of Pueblos, or towns, which were the counterpart of the missions, or religious establishments. Eventually the missions were disestablished, or secularized, and California was governed as a dependency of Mexico until the territory was acquired by the United States in 1848.

In 1850 a State Government was established, California being admitted to the Union by an act passed by Congress on September seventh, 1850.

In the past half century California has made important contributions to the Nation, the first and one of the most important being the flood of the precious metal which was poured out of her mines from 1848, the year of the gold discovery, and continued until the present time, although in diminished volume. But the greatest advantage which the Nation derived from the acquisition of California was that it gave the United States not merely an outlook upon the Pacific, the greatest of the world's oceans, but the command of a coast line of more than a thousand miles, including the best harbors, and thus insured this country the future mastery of Pacific commerce.

An Inspiration for Worthy Work

BY HONORABLE FRED M. WARNER, GOVERNOR OF MICHIGAN



Fred M Warner

IT has been to me a source of pride to realize that there are States in our Union whose citizens feel that their history gives them a special reason for pride and self-congratulation.

New York, Massachusetts and the older States that had to do with the earlier contests of our country for existence and a place among the nations of the world, have well earned the proud position among their sister States which they have always occupied.

Surrounded as is our State by the inland seas of the republic, from Maumee Bay to Keweenaw Point, the lover of beauty and of the picturesque finds in Michigan that which is shared in full by none other of our sister States. And in those things which give commercial standing and business worth to a territory, the State of our homes, by birth and adoption, stands foremost in the list. In the great iron ore industry, in the production of copper, in manufacturing lines, and in its farms and their products, Michigan has come to be recognized as a leader in the quantity as

well as in the quality of these, her several important contributions to the wealth of the Union.

In the work that Michigan has done for higher education through its great State university, in its normal schools, which are excelled by no other institutions of their kind; in its Agricultural College, and schools for the blind, in the superior provision it has made for its grievously afflicted ones, its asylums and charitable institutions, and its splendid soldier's home, and in its institutions for the care of its homeless and helpless children, Michigan is not fully equalled by any other State.

Forty years ago Michigan ranked as the sixteenth State in the Union in population; thirty years ago our State had advanced to the thirteenth position, and the most recent census places us ninth on the list.

This would indicate that Michigan is rapidly growing in population and in the number and the value of its homes, and in that which affects the homes of Michigan lies that which gives inspiration to our efforts of the future and compensation for all worthy work for her sake in the past.

Strong New Blood Elevates Citizenship

BY HONORABLE BRYANT B. BROOKS, GOVERNOR OF WYOMING

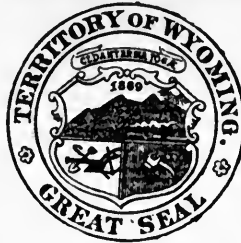

Bryant B Brooks

WYOMING enjoys the unique distinction of having been under more rulers and more kinds of Government than any other State in the Union. It has been under Ferdinand and Isabella, Charles I., Philip II., Philip III., Philip IV., Charles II., Philip V., Ferdinand IV., Charles III., Charles IV., Ferdinand VII., and Joseph Bonaparte of Spain; Francis I., Henry II., Francis II., Charles IX., Henry III., Henry IV., Louis XIII., Louis XIV., Louis XV., Louis XVI., the Republic and the Consulate of France, and Louisiana, Missouri, Texas, Oregon, Utah, Nebraska, Washington, Dakota, Idaho and Wyoming of America. It is the only State that contains lands obtained from all four of our principal annexations, which form the territory west of the Mississippi river.

Wyoming was organized as a territory July 25th, 1868, and admitted as a State July 10th, 1890, being the forty-fourth State, and a lucky number.

In bygone years this was the home of the great Sioux Indian, who was physically and intellectually the mightiest of his race, while in courage and ferocity unexcelled. Consequently, here is recorded some of the most fascinating history of hunter and trapper life in America.

Topographically it is a country of rolling plains, vast plateaus and lofty mountains. The present population numbering 125,000 people is engaged in agriculture, stock raising and mining.

The climatic conditions are ideal, altitude favorable, soil fertile and productive. Owing to the abundance of water supply, hundreds of thousands of acres will soon be brought under large irrigation canals through the instrumentality of the Reclamation Service and Carey Act projects, thereby furnishing homes for land hungry thousands. Immigration is received largely from the northwest farming States, where the young men have acquired a deep knowledge of, and abiding faith in agriculture, from the experience and successful work of pioneer forefathers. This infusion of strong, intelligent, courageous blood aids to elevate our citizenship.

Laws are enforced, life and property protected, and in matters of legislation, Wyoming stands well in the forefront of modern progress and reform. Her greatest need to-day is for better transportation facilities, capital with which to develop her innumerable resources, and sturdy men and women, who are not afraid to work, who will aid in making of this young Commonwealth the Pennsylvania of the West.

The Native Honesty of the Nation

BY HONORABLE JOHN C. CUTLER, GOVERNOR OF UTAH



John C. Cutler

IT is my belief that on the whole patriotism is increasing in the country at large. I know it is so in Utah, and I am led to believe, from my study of national events, that this condition is general. While some incidents have occurred, and have been magnified unduly, which some people may regard as menacing our national honor, I am firmly convinced that these will sink into insignificance and oblivion, when contrasted with the breadth and scope of patriotic Americanism, as exemplified in our great and admirable chief executive, Theodore Roosevelt. So long as our Nation is producing such men as he, its future is in no great jeopardy.

The first settlement in Utah was made at Salt Lake City, in July, 1847. Utah became a State in the year 1896. In contributions to the Nation, both in great men and great events, Utah has cause to be proud of its record. The greatest of these events—one that will stand out in the history of the Nation as pre-eminently important—is the establishment of the practice of irrigation, by means of

which the western half of the continent was given to the Union. The part taken by Utah in the settlement of the West, and the building of the great highways across the continent, is a prominent part of the State's splendid record. We also point with pride to the work of our batteries in the Philippines. To mention a few of the great men Utah has produced would necessitate the omission of many equally great. The founder of Utah was the greatest colonizer of modern times; one of her sons is a sculptor of international reputation; some of our scientists, artists, statesmen, painters, orators, and financiers have won the admiration of the world. The size and scope of this article will scarcely allow further particularization.

Utah's population to-day is about 335,000. By far the largest proportion of our people live by agriculture. We are receiving many immigrants every year. This fact is due in large part to the splendid opportunities afforded here for sturdy, honest immigrants, and partly to the missionary system of the Mormon Church, by

Message from Utah by Governor Cutler

means of which the solid, honest people of the European middle class are brought to Utah. The immigrants are Scandinavians, English, Welsh, Scotch, Dutch, Swiss, Germans, and a few Italians, Greeks, and Austrians. A very large part of our immigration is from various portions of the United States. Most of the immigrants go to the farms, and help to build up country settlements. As a rule they are thrifty. The general effect of immigration on the citizenship of Utah is very beneficial. About the only drawback in this respect is in the case of the elements which never become assimilated, such as the Italians, Japanese, Austrians, and Greeks. In Utah there are practically no labor troubles. Labor and capital has not become one of our vexed problems.

Utah is making greatest progress, perhaps, in mining. And the progress here is steady and healthy. In certain lines of manufacture, and especially in the making of beet sugar, there is a notable advancement. Agriculture and stock raising are also making rapid strides. In education, social advancement, religious progress, and in other worthy directions, our State is forging ahead as rapidly

as in material affairs. Light corporal punishment is still permitted in the public schools, and I approve of it when cruelty and harshness are prohibited, as they are by our school law. My views on capital punishment are strong. It is a part of Utah's code, and so long as I occupy the executive chair it shall remain so unless two-thirds of the legislators shall vote for its abolishment.

In my opinion, Utah's greatest need to-day is unity. A small faction of malcontents, disappointed politicians, and others of their kind, has been formed, and is doing a little to stir up strife and create false impressions abroad. But the better element of Utah's citizenship protests against the methods of these breeders of strife, and we confidently hope that before long they will leave the State or join in promoting its interests. America's greatest need to-day, in my opinion, is political, social, and commercial integrity. And I think the events of the past few years indicate that the very few cases where a lack of this integrity has been revealed will soon be eliminated, and the general, native honesty of the Nation will again be without serious blemish.

American in Spirit and in Aspiration



BY ANDREW L. HARRIS, GOVERNOR OF OHIO



OHIO is pressing forward in many lines of honorable endeavor, and is keeping step with the progress of the Union. Incidentally, she leads all States in the extent of interurban electric railways.

It is difficult to say what is Ohio's greatest need. A distinct impetus would be given to her commerce by the improvement of the Ohio River.

Our greatest need as a Nation is "unity of purpose and unity of patriotism."

Patriotism is not waning; our love

Message from Ohio by Governor Harris

of country should be more fervent, pure and undefiled.

In war and statesmanship, Ohio has contributed Ulysses S. Grant, William T. Sherman, Philip Sheridan, William Henry Harrison, Rutherford B. Hayes, James A. Garfield, Benjamin Harrison, William McKinley, Edwin M. Stanton, Salmon P. Chase, and Allen G. Thurman. Salmon P. Chase and Morrison R. Waite were chief justices of the Supreme Court of the United States. In literature Ohio has contributed William Dean Howells, Albion Tourgee, the Carey sisters, and Paul Laurence Dunbar; in science, Thomas A. Edison and Charles F. Brush, Daniel Decatur Emmett, author of "Dixie," and Benjamin R. Hanby, author of "Darling Nelly Gray," were sons of Ohio.

Within the limits of the State

occurred the most serious reverse in battle ever suffered at the hands of the Indians,—known in history as "St. Clair's Defeat." Ohio was the scene of stirring events in the War of 1812, among them Major Croghan's defense of Fort Stephenson and Perry's victory on Lake Erie. In the Civil War the Confederate cavalry leader, John Morgan, made his famous raid through the State and was captured near Lisbon, Ohio.

The population of Ohio in 1900 was 4,157,543. It is now probably about 4,400,000.

The better element of our foreign population rapidly becomes American in spirit and aspiration. The objectionable element is so small relatively that it does not seriously affect the citizenship of Ohio.

Wholesome Immigration is a Builder



J. O. Davidson

WISCONSIN'S fervent civic patriotism, evinced in the great Civil War, has lessened in no degree, and an eager, intelligent, and well-informed people will do their part with the rest of the nation in effecting the total extirpation of special privilege throughout our common country.

The distance between the head waters of the rivers flowing into the Great Lakes and the Mississippi, being shortest in Wisconsin, this territory naturally very early became a far-famed region of exploration and trade in the development of New France. Previous to the fall of New France in 1763, the French had several military posts within its borders, chiefly at Green Bay, Prairie du

Message from Wisconsin by Governor Davidson

Chien, Lake Pepin, and Chequamegon Bay (La Pointe).

Wisconsin was included in the Old Northwest Territory; subsequently it was a part of Indiana and Michigan, respectively; it was erected into a territory by itself in 1836; and on May twenty-ninth, 1848, was the last part of the Old Northwest to be admitted into the Union as a State.

During the War of the Rebellion, Wisconsin contributed a larger percentage of its male population to the Union Army than any other State. In this contribution was the famous iron brigade, and its commander, Edward S. Bragg, later United States Consul-General at Hongkong.

Matthew H. Carpenter, James R. Doolittle, William F. Vilas, John C. Spooner, and Robert M. La Follette are among the men who have represented Wisconsin in the United States Senate,—all of them well-known national characters.

Timothy O. Howe, William F. Vilas, and Jeremiah M. Rusk have been members of president's cabinets.

The Babcock test, in determining the butterfat value of milk, was an important contribution to science and to civilization, made by Stephen S. Babcock. Professor Babcock is one of Wisconsin's modest and unassuming citizens. His discovery, although royalty thereon might have brought to him millions of dollars, was gratuitously given to agriculture by Mr. Babcock.

Wisconsin, as shown by the State census of 1905, has a population of 2,228,947. The builders of the State were, in a very large proportion, foreign-born,—Norwegians and Germans predominating. The proportion of native-born is, however, steadily increasing. The emigration, which is still coming into the State, is of the most desirable class, being largely Scandinavian and Teutonic. The people of Wisconsin possess the national characteristics of honesty, frugality and thrift.

Agriculturally, Wisconsin is a rich commonwealth. While tobacco is, from a moneyed point of view, perhaps, its most important agricultural product, it is by no means a one-crop State. Its agricultural interests are much diversified, dairying being a close second in value of product.

As a manufacturing State, Wisconsin deservedly stands high. Its exceptionally good water-powers are as yet largely undeveloped, and they promise abundantly for the future.

The lead and zinc mines of Southwestern Wisconsin, which were largely worked during the period of 1828 and 1855, are now being reopened, especially for the zinc deposits, and their bi-products, especially sulphuric acid, and it seems likely that Wisconsin will prosper more on account of them in the future than it has in the past. We have also extensive iron and copper mines.

Because of the diversification of industries, our manufacturing establishments are fast growing in number and power, our farms are constantly in need of more men than can be obtained, our fisheries on the Great Lakes and inland waters are growing yearly, our railways are pushing out into territory not yet gridironed, and the opportunities thus afforded for labor and capital, economic and social problems have not as yet much perplexed Wisconsin.

It was in Wisconsin that the modern humane treatment of the incurably insane was first experimented upon, and in harmony with the spirit thus manifested, the State at an early date abolished capital punishment, being one of the four or five States in the Union that does not take life.

The exceptional water-power, the fine building stone,—granite, lime, and sandstone,—and the still undeveloped agricultural lands of Wisconsin, our great fisheries, and far-reaching manufacturing interests, all call for a larger population for their exploitation, and the State cordially welcomes emigration.

Commercialism Must Not Dominate America



BY HONORABLE JOSEPH M. TERRELL, GOVERNOR OF GEORGIA

THE tide of immigration has not turned this way. Still there is to be noticed a steady increase in sturdy immigration that assimilates with our blood—representing pure Americanism. This is the only people we want, feeling that it is better to have as our peasantry the negro, a distinct type, that cannot assimilate, than certain foreigners who might, by intermarriage, endanger our blood and institutions.

The foreigners who are coming to Georgia, as a rule, are of German, Scotch, Swede, English and Irish blood. Without appreciable exception they are thrifty. Georgia needs people of these types on the farm. Those we have are to be found in the cities, and their number is yet too small to have any effect on the civilization of our State.

There is no problem of capital and labor that threatens any industry in

our State. Georgia is practically a stranger to strikes.

Corporal punishment in schools has been abolished in most of the local systems. (Each separate board of trustees determines this question); but capital punishment remains on the statutes of our State, with no indication that it will be a repealed law.

Georgia has a population of 2,750,000—more than half being American blood—balance largely made up of negroes, who are tractable.

The people of the State are supported, in the main, by four industries: Agriculture, Commerce, Manufacturing and Mining.

Georgia is the only State in the Union that ever whipped, single-handed, a powerful Nation, six hundred and fifty settlers defeating seven thousand Spaniards, with an armed fleet, who were bent on invasion. She was likewise the only original colony that did not allow slavery under her formative constitution. She was forced, by a spirit of competition with

Message from Georgia by Governor Terrell

Massachusetts, Connecticut, Rhode Island and South Carolina to petition for this industrial vantage in 1749—but with the distinct provision that the slaves should never be used in competition with white labor, and that they should further be compelled to observe the Sabbath day.

Among the representative men of international fame that Georgia contributed to the world of action during the Colonial and Revolutionary periods, may be mentioned: Oglethorpe the founder; Noble Wimberly Jones, "the morning star of liberty;" Tomochichi, the greatest Indian chief of that period; Nancy Hart, the heroine of the Revolution; Jackson, Habersham, Pulaski and others.

Georgia gave Eli Whitney, the discoverer of the cotton gin, to the field of industry; she presented Dr. Crawford W. Long, the discoverer of anæsthesia, to the world of science; and she suggested steam-propelling to navigation, through William Longstreet, one year before Robert Fulton made his successful trial trip.

Her contributions to the gospel may be read in such lives as Jesse Mercer, George F. Pierce, Willard Preston, Bishop Gartland and Father Ryan.

In the Wesleyan Female College Georgia built the first institution of learning in the world to confer degrees upon women.

Some of Georgia's notable statesmen are: William H. Crawford, John McPherson Berrien, John Forsyth, Robert Toombs, Benjamin H. Hill, Alexander H. Stephens, Joseph E. Brown, the war Governor, Howell Cobb and Charles F. Crisp (the two last named having been Speakers of the National House of Representatives), and General John B. Gordon.

During the war between the States Georgia bore herself with the same unconquering devotion to duty that had always characterized her people. She gave one hundred and twenty-five thousand men to the struggle, and

such was their gallantry that she had one hundred and seventy-two officers killed on the battlefield,—among them seven generals.

In the Spanish-American war Georgia furnished more volunteer troops, according to population, than any State in the Union.

The principal instances of improvement in which Georgia excels are: Agriculture, Mining and Manufacturing. Our State contains more granite and marble than all the States of the Union combined—and much in gold, iron, coal and aluminum.

The greatest need of our State is to be let alone—and to grow politicians and editors who will let the race question alone.

In agriculture and horticulture Georgia excels. She grows sixteen million peach trees; produces more and better water-melons than any country on earth; markets two million bales of cotton, and has fields of Bermuda that are second only to the blue-grass fields of Kentucky.

Georgia was settled as a colony in 1733, the date of settlement being February 12, and the site Savannah.

She became an independent State April 15, 1776.

Oglethorpe, the settler of Georgia, proved a great forerunner of civilization. The colony first emblazoned a purpose to lead by building the tallest light-house then on the Atlantic coast a few months after the date of settlement. One of these first settlers, John Wesley, gave Methodism to the spiritual world.

America's greatest need is to produce a type of public men who will attend to their own business, and quit this interminable intermeddling with other people's affairs.

It seems that patriotism is waning in our land as the love of money increases. America needs education on this line. Fortunately for our State her people are not dominated by commercialism to the extent of forgetting the higher duty.

The Spirit of Patriotism Still Lives

BY HONORABLE WILLIAM T. COBB, GOVERNOR OF MAINE



W. Cobb

MAINE has never failed to manifest her fidelity to the Union and in early life her sons learn that the noblest ambition of a manly life is to suffer for liberty. From the sixteenth century to the present time in every conflict that has encompassed this land, Maine has, owing to her exposed position, suffered more or less. From the days of her starving Plymouth colonists to the present she has cheerfully done her part in succoring her friends and allies. She has ever been a central figure upon the stage, a shining star in the constellation of States.

Upon the Nation's roll of honor Maine has etched many names besides Hamlin, Washburn, Fessenden, Dearborn, Morrill, Blaine, Dingley, Fuller and Reed. She has reared twenty-seven of her forty governors, furnished twenty-one governors for other States, supplied the Nation with nine major-generals, nine brigadier-generals, six rear-admirals, two commodores, three commanders, and furnished more mental timber to other States in proportion to her population than any other State. The blood of Maine runs in every State of the Union. Governors, senators, judges, congressmen, from the Atlantic to the Pacific, claim a part of her greatness as their birthright. In addition to her generous gifts of men qualified to

manage the affairs of the Nation, she has contributed liberally to the world of literature, science and art.

In National affairs Maine has often wielded an influence out of proportion to her size, location, population and apparent interests. With a population of 694,466, a land surface equal to one-half of all New England, with almost unlimited and only partially developed resources, Maine is entering an era of great promise. The increase in our population has been smaller on account of the large number of our citizens who have gone to the West, and yet our growth has been steady both in population and wealth.

While it is difficult, if not impossible, to fix the exact date and place of the first settlement in Maine, it is conceded that many settlements had been established along the coast and inland some years prior to the landing of the Pilgrims on Plymouth shore. It is safe to say that permanent settlement had begun in 1607 in the region of the Kennebec and Sagadahoc. The men of Maine, the Pophams, the Gilberts, and the Gorges, are rightfully termed the fathers of New England colonization. The Maine shore was an objective point for the early explorers and adventurers, and our claim to priority of settlement in New England is well founded.

Until within the last two decades Maine has been an agricultural State

Message from Maine by Governor Cobb

and while the present condition and future prospects of the agriculture of the State is most hopeful and encouraging, the majority of people engaged in gainful occupations are those following manufacturing and mechanical pursuits.

Maine's extensive fisheries are one of her best known industries. Approximately 25,000 men are employed in reaping her annual fish harvest of more than \$4,000,000. Lumber is a great revenue producer; the woods of Maine yield a yearly sum of at least \$15,000,000.

Her extensive water-power has been a great aid in developing her manufacturing industries. The manufacture of wood pulp has developed greatly during the last few years and two of the largest mills of the world are located within her borders.

The city of Bath is known as the cradle of American shipbuilding where have been built craft varying from the highest type of government vessels to the six master schooners, the biggest cargo carriers of the type extant.

Aside from the commercial and manufacturing lines, the summer visitor is a constantly increasing source of revenue and gratification. The four hundred thousand pleasure-seekers, attracted by the salubrious summer climate, the beautiful and varied seashore and mountain scenery and unequalled sporting, fishing and hunting privileges, leave nearly sixteen million dollars in various summer resorts and pleasant abiding places. With magnificent and extensive forest, and a coast line of 278 miles, from Quoddy Head to Kittery Point, which, by the wonderful network of bays and inlets becomes nearly 3,000 miles (greater than any other State), Maine offers greater natural attractions than any other commonwealth.

The industrial condition of the State is not materially affected by immigration. Only about thirteen per cent of the population are foreign-born. They are of the different na-

tionalities, follow various occupations, and seem to be contented and well-to-do.

The people of Maine are possessed of a generous, public spirit and a humane tendency. A common school system was adopted very early in the history of the State and all institutions of an educational nature have been liberally patronized by the State. In her hospitals, prisons and reformatory institutions, her unfortunate and evil-minded are provided for by scientific and rational methods. The death penalty was abolished in 1878 and although it was restored for a brief time, it has never been in real operation since that date and unless conditions change considerably that law will never be re-enacted.

Maine enjoys prosperity in her varied industries, and her workingmen are a class of such intelligence and character as to induce reasonable demands on their part and fair treatment on the part of the employers. The spirit of trade unionism, while it has become an important factor in industrial conditions, is opposed to drastic measures. The affairs of the Union are, for the most part, wisely and justly handled, and there is no apparent desire to do injustice or wrong to others. On the other hand, the labor organizations have done much to advance the interests of laboring people.

The spirit of patriotism still lives in the hearts of the citizens. They want peace, but should war come Maine would respond as promptly as she ever has. In the minds of the people there is a marked difference between the patriotism of the military ages, when war was the chief business of a country, and the present day spirit of devotion and duty to country. The patriot of our day is the just and not the fighting man; he is the patriot of peace; the man who lives honestly, injures no one, does the best he can in his calling, is helpful and kindly to all.

The "Miracle" of the First Steamboat

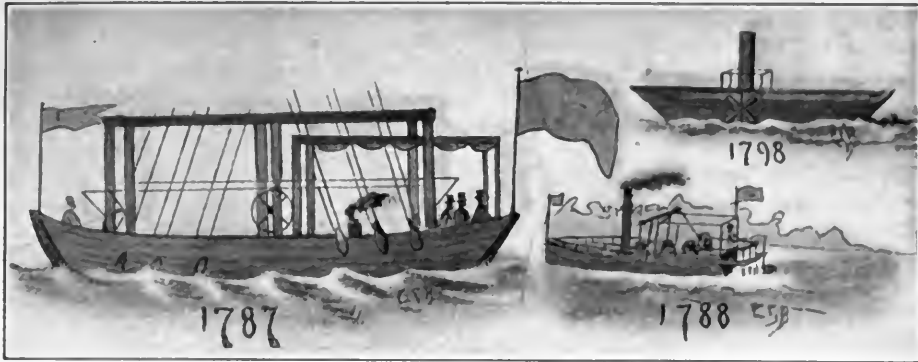

WORLD'S FIRST STEAMBOATS—Built and Successfully Run by John Fitch

Tragedy of an
American Genius who was
Publicly Ridiculed as a "Fanatic"
for Proposing the Propulsion of Vessels by
Steam against Wind and Tide & The Idea was Pronounced
"Impracticable" and to Risk Life in its Undertaking "Foolhardy" & Related

BY

SEYMOUR BULLOCK

AFTER TWENTY-FIVE YEARS' INVESTIGATION OF THE DEVELOPMENT OF STEAM NAVIGATION

AN "unpractical" man's "impracticable" theory that steam could be used to drive vessels against wind and tide met the ridicule of the "sound-headed" men of the business world a generation or two ago. When a few months later a strange craft, puffing smoke from a tall stack, wierdly scooted over the waters at the mercy of a man at a crude throttle it was proclaimed a "miracle." Men with business judgment advised sane people to avoid it and not to risk their lives in its power.

Indeed they spoke better than they knew—it was a miracle. A miracle inasmuch as its value to civilization is beyond the power of human mind to

compute; a miracle that has thrown wide open the gates to the world; a supernatural "elastic vapor" that has reduced time and space and moved the world along at a pace an hundred-thousand-fold more rapidly than before its discovery. Until to-day the nations of the earth through the power of modern transportation facilities are exchanging products at the magnitude of seventy million dollars a day—or an estimated value of about twenty-five billions during the year that has just closed.

It is the story of this "unpractical" man, who had the courage to face the rebuffs of his business contemporaries and who closed his life in discouragement and tragedy, that is here told.

The "Miracle" of the First Steamboat

"**T**HE day will come when some more powerful man will get fame and riches from my invention, but nobody will believe that poor John Fitch can do anything worthy of attention."

These words of the discouraged inventor who first demonstrated the practicability of the propulsion of vessels by steam, came to my mind as I stood over his unmarked grave in the little burial spot in Bardstown, Kentucky, a few days ago.

My life-long researches into the development of steam navigation have led me several times to that shrine, but never before has the fickleness of fortune impressed me more forcibly.

As I looked upon the neglected grass-grown plot that lay about thirty feet from the fence on the north side and but little more from the fence that ran along the east side—fourteen feet north of a stone that bore the name Jesse McDonald—, I thought of the oft-repeated yet unfulfilled wish of the man who had opened up the gates of the world's commerce and had received in compensation only a narrow six-foot-deep strip of otherwise worthless earth, the exact location of which seemed scarce saved from the all-hiding hand of oblivion. John Fitch—unappreciated in life, unwept in death and unsung in story—had often wished that his last couch, when, wearied with life's uneven battle, he should lay himself down to sleep, might be placed "where the song of the boatman would enliven the stillness of his resting place and the *music of the steam engine* soothe his spirit."

The world's greatest benefactions have come through the hands of poverty; the story of a poor man's life, however, is thought to be hardly worth the telling. But when that poor man proves to be the genius who first successfully hitched his oars to the power of steam, then men may be

brought to read his story and to even join in sounding his praise.

No claim is made that John Fitch was the sole "original inventor" of the steamboat, in the sense that no one but he had thought of the possibility of using the power of steam for navigation. He was an original inventor in that he successfully linked together a steam engine and a method of propulsion for boats before he knew that anyone else had ever even attempted it. The boats that he built were not magnificent marine palaces, like the boats upon the Hudson and the Mississippi to-day; they were not monstrous leviathans into whose cavernous maw thousands and thousands of tons of freight could be stored, but they were the first successful champions in the battle for supremacy over wind and tide and to them must be given the credit of demonstrating that it was possible to travel by water and yet keep engagements by set appointments in time.

Revolutions so far reaching as contemplated in the scheme of Fitch must necessarily move slowly. The world of to-day differs more from the world that John Fitch knew than that world differed from the world of Julius Cæsar and the great difference has been wrought by the development of the ideas that he incorporated in his first steamboat. The boats of his day differed from the boats Cæsar saw upon the Mediterranean only by the cut and set of their sails. The boats of to-day differ from those of a hundred and twenty-five years ago in nearly every feature. Yet, as the forest lies hidden in the acorn, the "Minnesota" and the "Dakota," the largest freight carriers in the world, built at New London, and now plying the waters of the Pacific, were hidden in that little craft that John Fitch launched in a small meadow-stream in 1786.

Although the ancients knew of the expansive force of confined steam but little use was made of it until men of modern times demonstrated its utility

The Tragedy of an American Genius

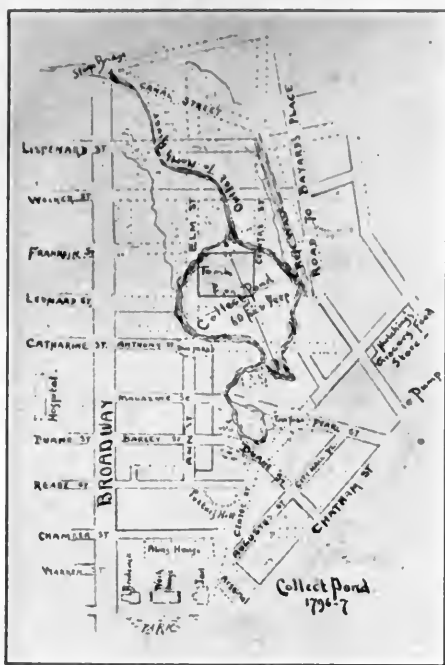

COLLECT POND, NEW YORK, UPON WHICH FITCH SAILED HIS STEAMBOAT OF 1796-7

and no small share of the honors that the Present renders to the not-far-distant Past is due to John Fitch for the part he took in that demonstration.

The time had come for the turning of a new leaf in the world's book of progress. A new hour had been struck on the "Horologue of the Ages." The "Old World" was to be brought over and anchored alongside the "New" with but enough water-filled space left between them to set for each the bounds and limits of its own. To John Fitch was given a dream—a tantalizing haunting dream that held him in its power day and night—in which he saw this thing made true.

Speaking of that time when he first thought to annihilate space through the application of steam, Fitch leaves this written confession:

In the month of April, 1785, I was so unfortunate as to have an idea that a carriage might be carried by the force of

steam along the roads. I pursued that idea for about one week and gave it over as impracticable, or, in other words, *turned my thoughts to vessels*. From that time I have pursued the idea to this day with unremitting assiduity, yet do I frankly confess that it has been the most imprudent scheme I was ever engaged in.

Up to this time Fitch had never heard of a steam engine. In the Franklin Institute manuscript, from which the foregoing quotation is taken, he says:

What I am now to inform you of is not to my credit but as long as it is the truth, I will insert it viz: that I did not know there was a steam engine on earth when I first proposed to gain force by steam. . . . A short time after drawing my first draft for a boat. I was amazingly chagrined to find at Parson Irwin's, in Bucks County, Pennsylvania, a drawing of a steam engine; but it had the effect to establish me in my other principles as my doubts lay at that time in the engine only.

Every part of the civilized world possessing any extended sea coast or navigable waters seems to have put forth at some time a claimant for the honor of having invented the steamboat. Spain presents Blasco de Garay, but of his work the editor of the *Franklin Journal* very suggestively hints that it is not wise "to date the history of the steamboat back so far as 1543 until the *Public Record* from which the account is taken shall appear in authentic form."

The next champion for the crown is Jonathan Hulls who published in London in 1737 a "Description and draught of a new invented machine for carrying vessels out of and into any harbor, port or river against wind and tide or in a calm, for which his majesty George II has granted letters patent for the sole benefit of the author, for the space of fourteen years." Accompanying this pamphlet is a drawing of a stubby little boat, with a smoking "chimney," having a pair of wheels rigged out over the stern which are supposed to be moved by ropes passed around their outer rims. To the axis of the wheels paddles are fixed for propulsion.

The "Miracle" of the First Steamboat

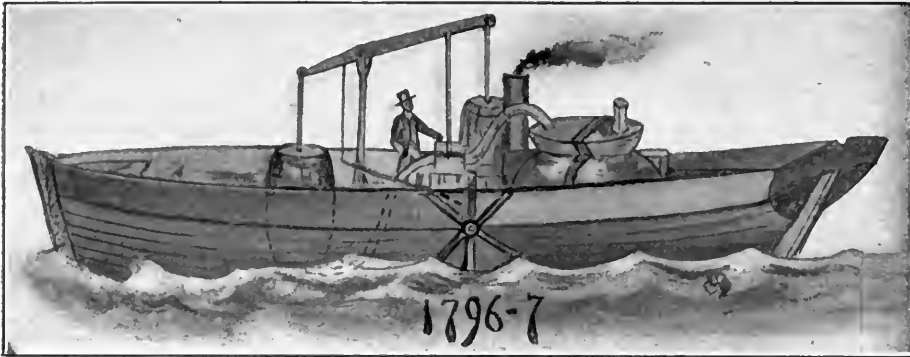

SIDE WHEEL STEAMBOAT THAT CREATED WONDERMENT ON COLLECT POND, NEW YORK—(From an old print)

It is not probable that Jonathan Hulls ever built any other steamboat than this one on paper. Leastwise there is no account of his doing anything further with the patent and I believe it safe in assuming that no one else ever became sufficiently interested in the "paper invention" as to have put its theories to the testing. The late Robert D. Roosevelt, of New York, wrote me shortly before his death: "I cannot allow the discussion of this subject to pass without putting in the claim of the Roosevelt family. I trusted that some other member of the family who had the actual proofs in his possession would come forward, but we are rather careless in claiming credit—especially when the public has made up its mind in another direction. It has always been a tradition with us that my grand-uncle, Nicholas J. Roosevelt, first ran a model steamboat as finally adopted by Fulton and made a success by him. He was connected with Fitch by marriage and business, and together they afterward exploited the Western waters, leaving Fulton the Hudson. You will find models of boats with oars propelled with steam. These were failures, and the little steamboat of my relative led the way for the wonderful invention which Fulton made successful. I do not like to seem to ignore or abandon our claim, which has been quietly maintained for

nearly a century and is upheld by a quantity of evidence."

When John Fitch built and launched his first boat it was no reproduction of any other. So unique was it that its builder might have fallen down before it in worship, and yet have been without sin, for it was not made like unto "anything that is in the heavens above, or that is in the earth beneath, or that is in the waters under the earth."

Fitch once exclaimed to friends: "The propelling of a boat by steam is as new as the rowing of a boat by angels and I can claim the first thought and invention of it."

The first model was built in Cobe Stout's log shop and tried on the small stream that ran through Joseph Longstreth's meadow about a mile and a half from Davisville, Southampton County, Pennsylvania. The boiler was made of an iron kettle, the machinery was of brass and the paddle wheels, thrown over the sides, were of wood. In all, Fitch tried seven different schemes for propelling the boat, building perfect models of four, and in September, 1785,—having already experimented with the screw-propeller, the endless chain, the paddle wheels and the large stern wheel—Fitch prepared and submitted to the American Philosophical Society of Philadelphia a "drawing and description of the machine . . . invent-

The Tragedy of an American Genius

ed for working a boat against the stream by means of a steam engine," and in the following December he "presented to the society a model and additional drawings," and in that same year, he wrote to Benjamin Franklin his belief in the practicability of sea navigation by steam.

In 1786-7 the sole and exclusive right to the waters of Pennsylvania and several adjacent states for steam propelled vessels was given to John Fitch. When he applied for this concession, he was experimenting with an engine having a three-inch cylinder and a propeller attached to a skiff. His efforts seemed to end only in failures and, stung by the jibes of the wiseacres with their eternal "I told you so," Fitch sought the tavern and tried to drown his disappointment in drink. The debauch ran through that night and the next day and then he seems to have gotten hold of himself. He went to bed early the second night to try to sleep himself sober but "about twelve o'clock (July 21) the idea struck me," he writes, "about cranks and paddles for rowing a boat and for fear that I should lose the idea, I got up about one o'clock, struck a light and drew a plan. I was so excited I could not sleep." Six days later Fitch had a craft of about nine tons burden fitted with paddles hung perpendicularly and moved by his re-arranged engine geared to a

crank. On the twenty-seventh (July, 1786) he gave a public demonstration—the trial trip of the world's first steamboat.

Having exhausted his own finances, Fitch applied to the Pennsylvania legislature for a loan of £150 and failing to obtain it—by a vote of thirty-two to twenty-eight—he applied to the speaker of that body, General Thomas Mifflin, for an individual loan of the amount. In soliciting this accommodation Fitch writes:

I am of the opinion that a vessel may be carried six, seven or eight miles per hour by the force of steam and the larger the vessel the better it will answer, and am inclined to believe that it will answer for sea voyages as well as for inland navigation which would not only make the Mississippi as navigable as tide water but would make our vast territory on those waters an inconceivable fund in the treasury of the United States. Perhaps I should not be thought more extravagant than I already have been when I assert that six tons of machinery will act with as much force as ten tons of men, and should I suggest that the navigation between this country and Europe may be made so easy as shortly to make us the most popular empire on the earth, it probably at this time would make the whole very laughable.

Fitch during that year built a second boat, forty-five feet long and twelve feet beam, which was an improvement in every way over its predecessor. Besides its larger proportions this boat had a much heavier engine. The trial trip was made on the

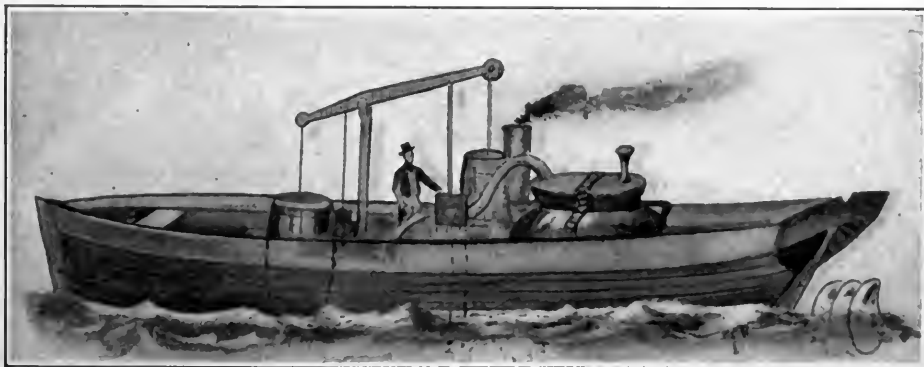

PROPELLER BUILT BY JOHN FITCH—CONSIDERED A MARVELOUS MECHANISM
(From an old print)

The "Miracle" of the First Steamboat

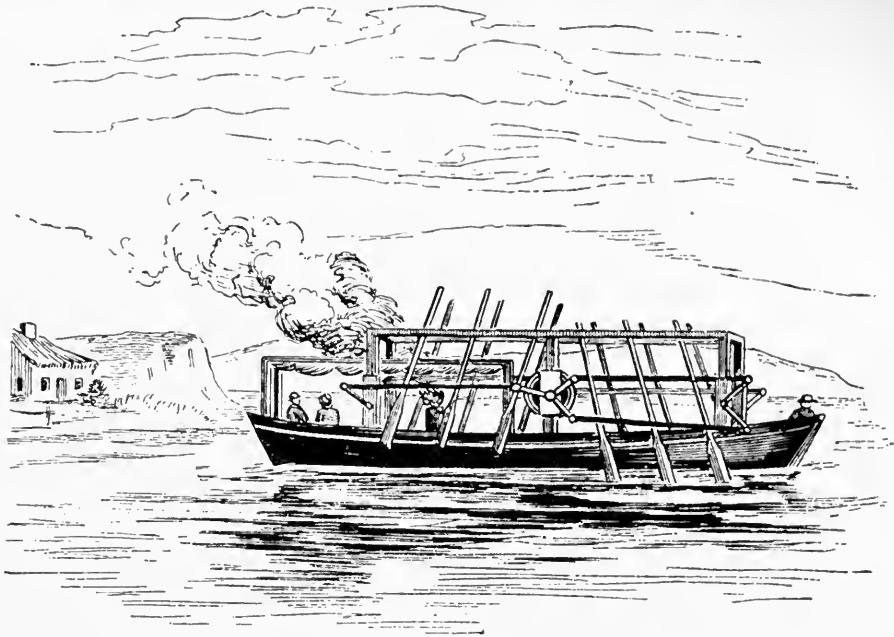

THE "PERSEVERANCE" ON THE DELAWARE RIVER IN 1787

Delaware river, August 22, 1787, and was witnessed by all the members of the convention for framing the Federal Constitution, except General Washington.

Chief Justice Oliver Ellsworth of the United States Supreme Court was the guest of the steamboat company on the initial trip of Fitch's new boat. Every one seemed to be satisfied with what was done except the inventor. Attainment seemed to only fire his ambition and he at once began to plan for greater things.

By the sale of maps of the Northwest Territory drawn by Fitch from his own surveys and engraved in the rude shop of Cobe Stout, the printing being done with a cider press, the sum of \$800 was made available for the new boat. A stock company of forty shares was organized in February, 1788, and the exclusive right to navigate by steam the waters of New York, March 19; Delaware, February 3; Pennsylvania, March 28, and Virginia, November 7, was given to the new enterprise "for a pe-

riod of fourteen years." The new boat was built and measured sixty feet in length with eight-foot beam. Paddles were set at the sides instead of at the stern as in the former boat. It was noised about that Fitch's new boat would be given its trial trip that twenty-second day of August and a crowd of the curious gathered to witness the event. Incredulity and anticipation stood staring each into the other's face. The lines were cast off, there was a puff of smoke and a whiff of steam and the odd, multi-legged creature began walking on the water. Three miles only were covered in an hour but it had been shown that something could be done. A rally was made and the forty original shares were doubled. A new and larger boat was built. The next summer this new craft, fittingly called the "Perseverance," ran on its trial trip from Philadelphia to Burlington, twenty miles. On the twelfth of October, 1788, a pleasure party of thirty was taken over the same course in three hours and ten minutes.

The Tragedy of an American Genius

Had this boat been launched on the Hudson, locked in by the towering hills over whose heights no ordinary roadway could be built, instead of on the Delaware along whose shore stretched a well-kept level road upon which swift (?) stages ran more than six miles in an hour, it is certain that no break would have been permitted in the chain that linked together the steamboats of three centuries. If the papers that published the account of Fulton's triumph had announced that on that August day of which so much is made, the "Clermont" and the "Perseverance" would leave New York at the same hour and race to Albany, each maintaining its accredited rate of trial-trip speed, their account of the race would have shown that when the "Perseverance" touched her wharf at the farther city the "Clermont" was fifty-two miles astern.

Fitch was not content with what had been accomplished with the "Perseverance" and at once proposed the building of a larger boat with a more powerful engine. The next year was spent in preparation and building and on the sixteenth of the April following (1790), a trial trip was made. Everything worked charmingly and Fitch writes: "Although the wind blew fresh at the northeast, we reigned Lord High Admirals of the Delaware and no boat in the river could hold its way against us but all fell astern, though several sail boats which were light, and heavy sails that brought their gunwales well down to the water, came out to try us."

Several other equally successful trips were made and the elated Fitch wrote again: "Thus has been effected by little Johnny Fitch and Harry Voight (a close friend) one of the greatest and most useful arts that has ever been introduced into the world, and although the world and my country does not thank me for it, yet it gives me heartfelt satisfaction."

In a description of this admittedly successful steamboat, which was pub-

lished under Fitch's name in the *Columbian Magazine*, he says:

The cylinder is to be horizontal and the steam to work with equal force at each end. The mode by which we obtain a vacuum is, it is believed, entirely new, as is also the method of letting the water into it and throwing it off against the atmosphere without any friction. It is expected that the cylinder, which is of twelve inches diameter, will move a clear force of eleven or twelve cwt. after the frictions are deducted, this force is to be directed against a wheel eighteen inches in diameter. The piston is to move about three feet and each vibration of it gives the axis about forty evolutions. Each evolution of the axis moves twelve oars or paddles five and a half feet; they work perpendicularly and are represented by the strokes of a paddle of a canoe. As six paddles are raised from the water, six more are entered and the two sets of paddles make their strokes of about eleven feet in each evolution. The crank of the axis acts upon the paddles about one-third of their length from their lower ends, on which part of the oars the whole force of the axis is applied. The engine is placed in the bottom of the boat, about a third from the stern and both the action and the reaction turn the wheel the same way.

From the very first demonstration of this steamboat, Fitch had held the unshaken confidence of a Dr. William Thornton and a Mr. David Rittenhouse, who, with Benjamin Franklin also a stockholder in the company organized to build steamboats, were members of the American Philosophical Society. Dr. Thornton was sometime afterward connected with the government patent office in Washington where he had access to all drawings and models illustrative of steamboating. From this unequalled opportunity to study all that others had done and were doing, Dr. Thornton was peculiarly fitted to write the pamphlet, "A short account of the origin of steamboats," in which he says:

Finding that Mr. Robert Fulton, whose genius and talents I highly respect, has been considered by some the inventor of the steamboat, I think it a duty to the memory of the late John Fitch to set forth with as much brevity as possible, the fallacy of this opinion and to show, moreover, that if Mr. Fulton has any claim whatever to orig-

The "Miracle" of the First Steamboat

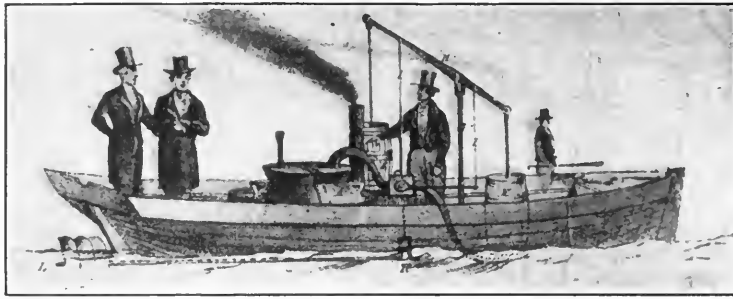

PROPELLER BUILT BY JOHN FITCH IN 1796-7

The figure in the centre is Fitch—At the extreme left stands Livingston with Fulton—This boat was sailed on Collect Pond, New York, in a demonstration to raise capital for organizing a corporation

inality in his steamboat, it must be exceedingly limited. In the year 1788, the late John Fitch applied for and obtained a patent for the application of steam to navigation, in the states of New York, Pennsylvania, New Jersey, Delaware, etc.; and soon after, the late Mr. James Rumsey, conceiving he had made some discoveries in perfecting the same, applied to the state of Pennsylvania for a patent; but a company formed by Mr. John Fitch under his state patents, conceiving that the patent of Fitch was not for any particular mode of applying the steam to navigation but that it extended to all known modes of propelling boats or vessels, contested before the assembly of Pennsylvania, and also before the assembly of Delaware, the mode proposed by Mr. Rumsey and contended that the mode be proposed, viz.: by drawing up water into a tube and forcing the same water out of the stern of the vessel or boat, which was derived from Dr. Franklin's works (Dr. Benjamin Franklin being one of the company), was a mode the company had a right to, for the plan was originally published in Latin about fifty years before in the works of Bernonilli the younger.

The decision of the assembly in both states where the issue was raised was in favor of Fitch and the Rumsey company "were excluded from the right of using steamboats on any principle." In the violent pamphlet controversy between these two claimants for the honor of having first applied the power of steam to navigation, it was shown that Fitch, when *en route* to Philadelphia to interest men and capital in his invention, had passed through Winchester, Virginia, and had stopped to rest at the home of a friend to whom he declared his "firm conviction that the agency of

steam might be used in navigation," stating that he "was then on his way to Philadelphia to awaken interest in such an invention." Rumsey is said to have learned this. Be this as it may, it is certain that the world would yet be without its swift sailing steamboats if it had been forced to depend upon the "suck-in, squirt-out" mechanism of James Rumsey's invention.

But, to go back to Dr. Thornton's story. Here is given in detail the difficulties under which Fitch built his first boat and then comes the account of the launching and the success that crowned him:

The day was appointed and the experiment made in the following manner: A mile was measured in Front (Water) Street, Philadelphia, and the bounds projected at right angles, as exactly as could be to the wharf, where a flag was placed at each end and also a stop-watch. The boat was ordered under way at dead water, or when the tide was found to be without movement, as the boat passed one flag, it struck and at the same instant the watches were set off; as the boat reached the other flag it was also struck and the watches instantly stopped. Every precaution was taken before witnesses; the time was shown to all, the experiment declared to be fairly made and the boat was found to go at the rate of *eight miles an hour*, or one mile in seven minutes and a half. . . . It afterward went eighty miles in a day.

Congress was in session and an adjournment was ordered that the members might witness the remarkable event and on the sixteenth of June, 1790, Governor Thomas Mifflin and the Supreme Executive Council

The Tragedy of an American Genius

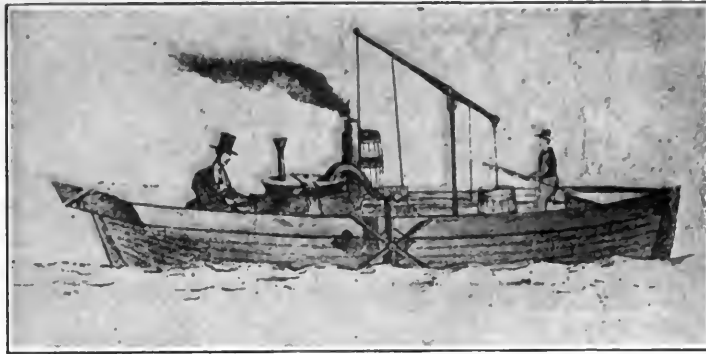

SIDE WHEEL BOAT BUILT BY FITCH 1796-7

With Fitch, the inventor, Fulton and Livingston made several trips about Collect Pond, New York, in this boat ten years before they placed the "Clermont" upon the Hudson

of Pennsylvania were passengers on the boat. Of the latter Dr. Thornton writes:

The governor and council of Pennsylvania were so highly gratified with our labors that without their intention being previously known to us, Governor Mifflin, attended by the council in procession, presented to the company and placed in the boat a superb silk flag prepared expressly and containing the arms of Pennsylvania; and this flag we possessed till Mr. Fitch was sent to France by the company, at the request of Aaron Vail, Esq., our consul at L'Orient, who being one of the company, was solicitous to have steamboats built in France. John Fitch took the flag, unknown to the company, and presented it to the National Convention.

The success of Fitch's boat found its way into print and during that summer a "card" appeared in the advertising columns of the two papers published in Philadelphia, announcing the regular sailings of the "steamboat." The *Pennsylvania Packet* of June 15 runs the first steamboat "ad" as follows:

The Steam-Boat

IS now ready to take Passengers, and is intended to set off from Arch Street Ferry in Philadelphia every Monday, Wednesday and Friday, for Burlington, Bristol, Bordentown and Trenton, to return on Tuesdays, Thursdays and Saturdays.—Price for Passengers, 2/6 to Burlington and Bristol, 3/9 to Bordentown, 5/1 to Trenton. June 14. tu.th stf

The same "ad" appeared in the *Federal Gazette* and *Philadelphia*

Daily Advertiser on June 14, 17, 19, 22 and 24, and on Monday, July 26, it was changed, abbreviated to read: "The steamboat sets out to-morrow at ten o'clock from Arch Street Ferry in order to take passengers for Burlington, Bristol, Bordentown and Trenton and return next day."

This was the first steamboat line in the world and the first use of any steam-propelled carrier for hire.

Later in the year a letter was printed in the *New York Magazine*, dated Philadelphia, August thirteenth, containing the words: "Fitch's steamboat really performs to a charm." The boat had then been running two months and was maintained all that year and the next summer. Her frame rots to-day on the south side of Cohocksink Creek.

In 1788-9 another boat was built and successfully launched. On the night of the day she made her trial trip, she was burned to the water's edge. In 1791 further "patents" were secured and a boat was built for a New Orleans route. When nearly completed a storm tore this new craft from its moorings and drove it over onto Petty's Island, opposite the upper end of Philadelphia, where it became embedded in the mud. Constant interference with Fitch's plans and the substitution of worthless inventions by shareholders had made

The "Miracle" of the First Steamboat

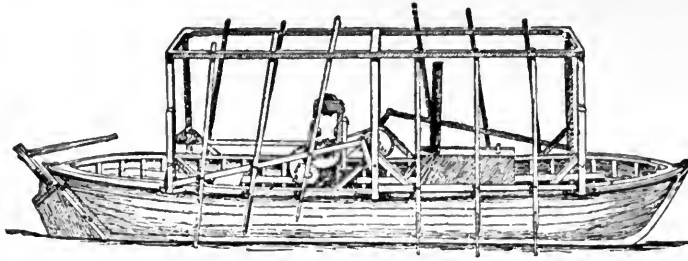

ORIGINAL MODEL OF JOHN FITCH'S STEAMBOAT

Presented by Fitch to the American Philosophical Society of Philadelphia—Now in the Smithsonian Institute

the building of this boat very expensive. The shareholders were discouraged and would advance no more funds. Fitch had spent his little "all" and the boat was abandoned. For four years it lay in the mud where it had first stranded and then it was advertised as for sale at auction on the eighteenth day of August, 1795.

Boat building has always been a good butt for a joke. The first man who launched a log and straddled it, using his hands for paddles, afforded no end of merriment to the other fellow who was "looking on." Noah's boat was the most ludicrous thing his contemporaries had ever seen. Poor John Fitch soon found himself to be the "laughing-stock" of the town but through it all he said: "Never mind, boys, the day will come when all our great lakes, rivers and oceans will be navigated by vessels propelled by steam."

The patent that Fitch received from the Federal Congress, signed by George Washington and commissioners Thomas Jefferson, General Henry Knox and John Randolph, ran for a period of fourteen years from August 26, 1791. It was this patent, with the Rumsey-Fitch pamphlets, that the opponents to the Fulton-Livingston monopoly used to break the exclusive franchise held for the waters of New York.

Knowing that his friend Rittenhouse was fully cognizant of the details of this patent, Fitch wrote to

him, upon the abandonment of the Philadelphia-Trenton steamboat line in 1792, urging him to purchase his lands in Kentucky that he might "have the honor," as Fitch says, "of enabling me to complete the great undertaking."

In this letter Fitch writes: "It would be much easier to carry a first-rate man-of-war by steam than a boat as we would not be cramped for room, nor would the weight of machinery be felt. *This, sir, will be the mode of crossing the Atlantic* in time whether I bring it to perfection or not for packets and armed vessels." He suggests further on that steam be used to conquer the Barbary pirates who had recently captured several American vessels. "A six-foot cylinder could discharge a column of water," he says, "from the round-top forty or fifty yards and throw a man off his feet and wet their arms and ammunitions"—a device actually reported in England some years later as having been incorporated as part of the armament of the "Demologos," the first steam war vessel in the world.

The "Demologos" was built for the War of 1812 upon the urgent solicitation of "a number of gentlemen in New York associated under the title of a Society for Coast and Harbor Defense." Their chief object was to bring into operation a Steam frigate in addition to the measures already adopted for annoying the enemy within our waters. The "memorialists"

The Tragedy of an American Genius

who urged this innovation were appointed by the secretary of the navy to act as "his agents to superintend the construction of a vessel of war to be propelled by steam" and they in turn announced for themselves that "Messrs. Browns are to be the naval constructors and Mr. Fulton is the engineer for completing the grand design originally conceived by himself."

As originally planned the "Demologos," afterward known as "Fulton I," was to have been a mastless vessel, but Captain David Porter, who had just returned from the unfortunate cruise of the "Essex" and been assigned to the navy yard to superintend the building of this new-style craft, had ordered that two masts be stepped, upon which were hung lateen sails with the accompanying top-hamper, and the installation of a bowsprit. Before the time had come for the launching he seemed to have grown more apprehensive of dangers hidden in the strange creature and ordered several other changes. Two boilers or "cauldrons for preparing steam" as they are termed in the report, were substituted for the one designed by Fulton. Guns that were originally on the British ship "John-of-Lancaster," which had been captured early in the war, were hauled overland from Philadelphia and mounted on her decks. The day of launching was a gala day for all New York and vicinity. At eight forty-five Saturday morning, October 24, 1814, the "Steam Battery Fulton, the First," slipped from her cradle and rested on the waters of the East river. In the following June the "Demologos"—Fulton's name for the boat—carried a party of officials out onto the waters of New York Bay. On the fourth of July a trip to sea—covering from fifty-three to fifty-five miles—was made—John Fitch's prophecy of a steam war-craft had been fulfilled.

Stories travel far and in England it was reported that we had a craft "three hundred feet long and two hundred feet wide, with sides thirteen

feet thick built up of alternate oak plank and cork wood. There are forty-four guns, four of them one hundred pounders on the main deck and quarter deck. The fore-castle-deck guns are forty-four pounders. And further to annoy an enemy a *mechanism to discharge one hundred gallons of boiling-hot water every minute* and, by a new contrivance three hundred cutlasses are brandished over her gunwales, and an equal number of heavy iron pikes of great length dart from her sides with prodigious force—darting and withdrawing every quarter of a minute."

The "Demologos" after her "trip to sea" was taken to the Brooklyn Navy Yard and used as a receiving ship. On the fourth of June, 1829, her magazine, containing two and a half barrels of damaged powder, used for firing the morning and evening gun, exploded and destroyed the vessel. No other steam vessel was added to the navy—except a galliot of one hundred tons, named the "Sea Gull" purchased in 1822 to suppress piracy in the West Indies—until the "Fulton II" was built for the government in 1837. The engines for the "Fulton II" were built by William Kemble of the West Point Foundry Association and were made up of successful innovations in marine enginery. This boat ran a race with the British steamer "Great Western" and easily vanquished her opponent. She did service till 1842 when she was laid up at the navy yard till 1851. In the latter year she was pulled out onto the ways and thoroughly overhauled before being sent to the West Indies on "cruising duty." In 1861 she was called back and "placed in ordinary" at Pensacola and that same year fell into the hands of the Confederates and was destroyed with the navy yard, May 9, 1862.

With the exception of a little paddle wheel tug bought in 1836 and used as a despatch boat, our navy had no other steanboat until the launching of the "Mississippi" and the "Mis-

The "Miracle" of the First Steamboat

souri" in 1842. These two vessels were planned at a meeting of the naval board in 1839 and at the same time plans were laid for the "Michigan" which was the first iron steam war vessel in the world. The "Michigan," built in 1842, is yet in active service on the Great Lakes and the original engines are yet in use as placed in the hull at first. These three boats were the first to be built under the entirely new branch of naval economy organized by Captain Matthew C. Perry, a brother of the hero of Lake Erie in 1813.

The "Missouri," whose engines were built at Cold Spring, New York, under the supervision of William Kemble who had built the engines for the "Fulton II," was burned at Gibraltar in 1843 by the careless dropping of a cask of turpentine which ignited. The "Mississippi" twice circumnavigated the globe; was flagship in the Mexican War; led the fleet as flagship in the expedition of Commodore Perry to Japan; carried Kossuth, the Hungarian patriot, from Turkey to France; was flagship at the engagement of Pei Ho river in 1859, and was one of the first ships to the front at the outbreak of the Civil War. She took part in the midnight attack upon Port Hudson. Riddled by shot poured into her while grounded, she was there fired by the crew that had so proudly sailed her and sunk in the waters whose name she had so gloriously borne.

The same year that witnessed the launching of the "Mississippi," the "Missouri" and the "Michigan," saw also the building of the "Princeton"—the first screw war vessel ever built, the first to have its machinery below the water line, the first to burn anthracite coal, the first to use "blowers" for artificial draft and to have a collapsible or telescoping smoke-stack, and the first to have engines coupled direct to the shaft. When the "Princeton" was launched, having Ericsson's screw and Ericsson's wrought iron gun, the war between

armor and projectile had really begun in earnest. After seven years of service the "Princeton" was broken up at the Boston Navy Yard in 1849.

But to return to the story of John Fitch. In 1796-7, upon a pond of water known as the "Collect" which remained up to very recent times where the Tombs Prison and the adjacent buildings now stand, Fitch had a yawl of about eighteen feet in length and six feet beam, with a square stern and rounded bow, in which he had placed an engine and boiler. The boiler was a ten or twelve gallon iron pot with a lid of thick plank securely fastened down by a transverse bar of iron. The cylinders of the engine were made of wood shaped like a stubby barrel on the outside and made straight inside, strongly hooped together. The main steam pipe led directly from the boiler top into a copper box, about six inches square which was called by Fitch "the receiver or valve box." "Leading pipes" led from the boiler into the bottom or base of each cylinder.

John Hutchins, who some time later published an account of the boat, was the "assistant" engineer and pilot. He tells us:

In the summer of 1796-7 Robert Livingston, Esq., and Mr. Fulton made several trips, on different occasions, around the pond and Mr. Fitch explained to them the modus-operandi of the machinery. I being a lad had conversation only with Mr. Fitch. From hearsay I believe Colonel Stevens of Hoboken, New Jersey, and another person by the name of Roosevelt had some knowledge of the enterprise and had some interest in its success. In conversation Mr. Fitch remarked to Mr. Fulton that in former experiments with paddle wheels it was found that they splashed too much and could not be used in canal navigation. No one in that time thought of having them covered.

Hutchins says that he afterward made several trips to see the "Clermont" and that he then recognized Fulton "to be the same man who was with us on the Collect." Hutchins gathered up the statements of men who had witnessed the steamboat

The Tragedy of an American Genius

demonstrations on the Collect pond. Among them he has two that are of special force.

Anthony Lamb, who was a brigadier-general and later an alderman in New York says:

I have a perfect recollection of having seen a boat on the Collect pond in this city with a screw propeller in the stern driven by steam across the pond. I do not recollect the year but I am certain that it was as early as 1796. It was about the size of a ship's yawl.

William H. Whitlock, who was for some time city surveyor, wrote:

It affords me much pleasure to state that I was an eye witness to the circumstance of a boat being propelled by steam on the Collect pond of this city about the year 1796.

Failing to interest others in what he saw to be so feasible himself, Fitch abandoned the boat with portions of its machinery, leaving it to decay on the muddy shore of the Collect. Piece by piece this prototype of the world's steam fleet was carried away by the children of the neighborhood.

Fitch was still firm in his convictions and talked steamboat wherever he could find an audience and for as long as his audience could be induced to stay. Soon after the New York demonstrations he returned to the scenes of his first experiments and from thence went into Kentucky. In a blacksmith's shop he met Jacob Graff, who had helped him on his first boat, and began to talk of those early days. The onlookers chimed in with ridicule to which he replied: "Well, gentlemen, although I may not live to see the time, you will, when steamboats will be preferred to all other means of conveyance and especially for passengers and they will be particularly useful in navigating the Mississippi river." As he went out of the shop Peter Brown, who had worked with John Wilson on the first boat, turned to the latter and said: "Poor fellow! What a pity he is crazy!"

Who was this man thrust thus upon the world before his time, who blazed

the way for others to riches and renown and then died, scarce wept—his only friend the poverty with which he had been so wholly in touch through all his years? What was his parentage? Where was he born?

In writing of himself in a manuscript bequeathed to the Franklin (Philadelphia) Institute, under the condition that its contents should not be known until thirty years after his decease, Fitch says:

The 21st of January, 1743, old style, was the fatal time of bringing me into existence. The house I was born in was upon the line between Hartford, Connecticut, and Windsor—(now known as the Old Road). It was said I was born in Windsor but from the singularity of my make, shape, disposition and fortune in the world, I am inclined to believe that it was the design of Heaven that I should be born on the *very line* and not in any township whatever; yet I am happy also that it did not happen between two states that I can say I was born somewhere.

He gives us, farther on in the manuscript, glimpses of his boyhood's home and tells us of two sisters, to one of whom he seemed to have been especially attached, and two brothers, one of whom he calls a tyrant. We are shown the school to which he was sent "one month in the year, because it didn't cost anything"—his father's obligations to him being limited to pointing out the way to Heaven and a way to make money for his sole benefit. The books that he used are all named: "The New England Primer from Adam's fall to the end of the Catechism;" an "arithmetic by Hodder which had the old-fashioned long division in it and went as far as Alligation alternate," and "Salmon's Geography"—which his father refused to buy for him and he finally purchased himself, through a neighbor who was going into the city, and paid for by selling "potatoes raised on the headlands at the end of the garden in soil dug up by hand on a holyday" (holiday)—the annual gathering of the militia. Only those who have heard an old grandfather's rhymes

The "Miracle" of the First Steamboat

I know of nothing so perplexing and vexatious to a man of feelings, as a turbulent Whig and Steam Boat building, I experienced the former and quit in season, and had I been in my right senses I should undoubtedly treated the latter in the same manner but for one man to be teased with Both, he must be looked upon as the most unfortunate man of this World,

LINES INSCRIBED BY JOHN FITCH IN HIS DISCOURAGEMENT

of those early days and listened to the distich:

"First Monday in May
Is training day,"

can have any adequate idea of the thirst for knowledge John Fitch must have had as a boy when he denied himself the crowd and the soldier's drill and stuck to his "digging" on this "holyday" to buy a book that would tell him "all about the whole world."

Page after page is taken from his life experiences before he comes to the story of the governor of the colony whose lands adjoined some meadow land owned by his father. One day, Fitch tells us, the governor had gained the consent of the elder Fitch to the boys' helping him survey some land that was to be cut up into small parcels for several purchasers. All day the weary-legged lad of eleven summers trudged over the fields carrying the surveyor's chain for the governor and at night the work had not been finished. The chain was left with young Fitch who was told how he should lay off the remaining lots and the next day found him early at his task. "I, being proud of the office," he says, "readily accepted it and executed it faithfully. Sometime after the governor called at my father's house for the chain; I fetched it to him with the greatest expedition, and expectation of some pennies. When he took

it, he put it into his saddle bag and rode off without saying a word! . . .

I am persuaded the governor was an honest man but concluded within himself that the honor of having helped him would compensate me."

This experience with the governor, Fitch says, was a forerunner of the treatment he was afterward to receive in the world. In another place he tells of a September day when the steeple was raised on the village church: "This was indeed a gala day and the people from Hartford and the whole country flocked to witness the uncommon spectacle." But on that day Fitch borrowed a horse that would otherwise have been in service and "rode to Rocky Hill, a parish in Wethersfield, where there were a great many coasters" and engaged berth for a short voyage that he might settle the question as to whether he should become a seaman or remain ashore and learn a trade.

After describing his experiences at sea and the treatment that he afterward received on land when he sought to learn a trade, Fitch tells us of his marriage on the twenty-ninth of December, 1767, to Miss Lucy Roberts of Simsbury. A son and a daughter were born to them. The daughter who married James Kilbourn, was born in 1769. Fitch "thought the world and all of little Lucy" but that marriage in 1767 was the beginning of the ending. He could not live

The Tragedy of an American Genius

happily with his wife and went out from his home to become a wanderer.

Notwithstanding what Fitch wrote about the vexations of a steamboat he continued his experiments and improved every opportunity, as we have seen, to interest others in his inventions. On his return from the fruitless trip to France, Fitch, who had worked his way homeward as a common sailor, landed in Boston and from there went to the home of Colonel King, who had married Fitch's sister, where he remained for some two years with occasional visits made to his daughter, Mrs. Kilbourne.

Leaving the hospitality of Windsor to claim possession of the lands he acquired when appointed "Deputy Surveyor" for Kentucky, Fitch passed through New York and made the demonstrations upon the Collect pond which should have won for him first place on the roll of honor. Arriving

at Bardstown, Kentucky, Fitch made another model of a side-wheel boat which he ran upon the nearby stream. Broken in health and in spirit, he gave up the project and handed over his model to one of the few friends who yet stood true and by whom it was kept for many years. A bargain had been made with the tavern-keeper by which Fitch was to give him half of the tract of land he had gone south to claim in exchange for board and a pint of liquor daily as long as he should live. Later the size of the piece of land was increased for an increase in the quantity of liquor.

There is an added tone of sadness to the story of this man when one stops to think of how unnecessary were all the deprivations and sufferings of the closing days of his life. At the death of her father, Mrs. Fitch, from whom the great genius had separated when the question of their per-

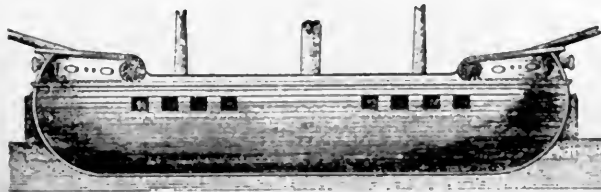
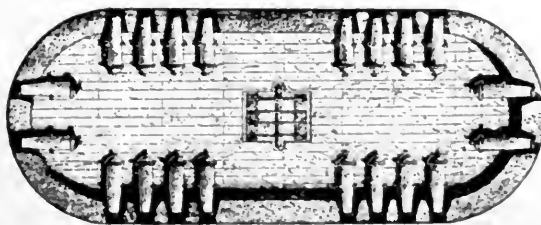
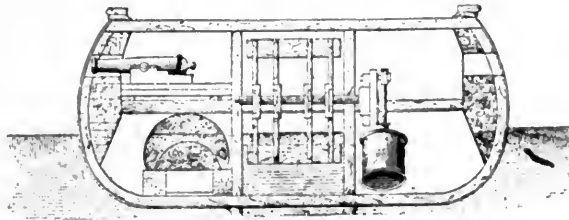

"DEMOLOGOS" THE FIRST STEAM WAR VESSEL IN THE WORLD

The "Miracle" of the First Steamboat

sonal religion was raised—he was a "skeptical" and she had just become a Methodist—sent her brother-in-law, Burnam, with a letter telling the husband that she had come into a considerable estate and urging him to return to Connecticut, where she promised to "maintain him like a gentleman for life," but he was inflexible and stubbornly refused to consider the matter. He sent a pair of silver shoe buckles to his son, Shaler, and a gold ring to his "little girl Lucy," but refused to send anything to his wife, despite the urging of his friend Garrison and his wife, with whom he was then staying.

Straight as an arrow, six feet two inches tall; thin and spare, face slim and complexion tawny; hair jet black, eyes dark and peculiarly piercing; temper sensitive and quick and stubborn—such was John Fitch. His ancestry, for he had a most respectable ancestry with a vellum of pedigree and a coat-of-arms, were originally Saxon and immigrated to Essex, England, from whence they came to Windsor, where the great-grandfather purchased one-half the original settlement, leaving it at his death to three sons—Joseph, Nathaniel and Samuel. From the loins of Joseph sprung

John, who was the father of the John to whom the boiling over of a teakettle suggested the latent force of steam.

Somewhere between the twenty-fifth of June, 1798, when he made his will and the eighteenth of the following July when the will was probated, poor John Fitch died. He could have been a rich man had he chosen, for Gardoqui, the Spanish envoy in this country in 1796, wanted to buy his invention for the "sole and exclusive use of my Master the King of Spain," but Fitch who had linked his fortunes with the feeble colonies in their struggle for liberty, said: "No. If there is any glory or profit in my invention my countrymen shall have the whole of it."

I would not ask that the honors be stripped from others that they may be bestowed upon John Fitch; but only ask that by the side of their names, his name shall be written equally large. His lone grave, unmarked and unkept is a silent witness against the manner in which we write history and a condemnation of the conservatism with which we cling to beliefs, however false, simply because they bear the stamp of long-gone years.

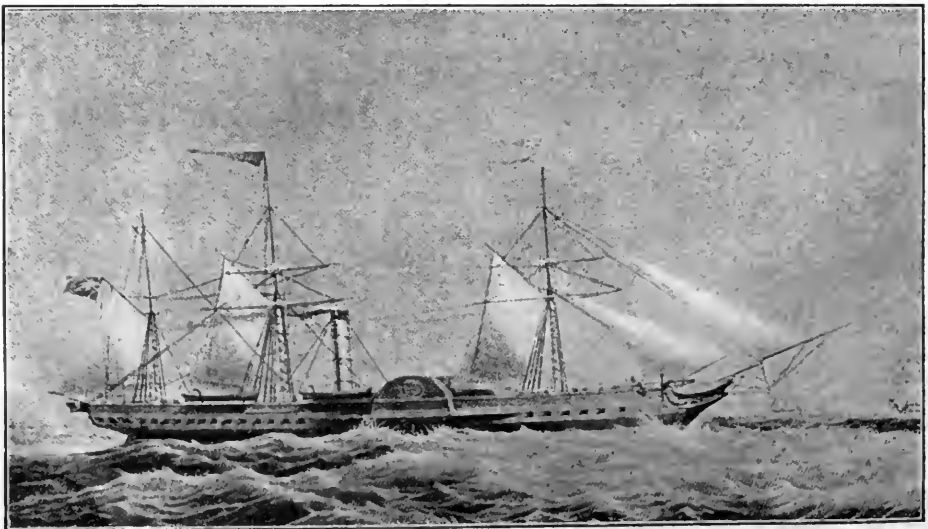

FIRST STEAMSHIP OF CUNARD LINE FROM LIVERPOOL TO BOSTON
The "Britannia" made her first trip in 1840. It was on this ship that Dickens experienced the storm at sea described in his *American Notes*, speaking of the many perils of the new science

Memoirs of a Southern Congressman

Ranging the
Southern Borderlands
with Daniel Boone & Encounters with
the Cherokees in Command of the Light Dragoons &
Electioneering in American Politics a Hundred Years Ago &
On the Floor of Congress during the Monroe Administration & Autobiography

BY

HONORABLE FELIX WALKER

MEMBER OF UNITED STATES HOUSE OF REPRESENTATIVES, 1808-1816—ONE OF THE ORGANIZERS OF FIRST GOVERNMENT IN KENTUCKY—FIRST CLERK OF FIRST COURT IN A SELF-GOVERNING DISTRICT CALLED WASHINGTON NOW INCORPORATED IN STATE OF TENNESSEE—BORN IN VIRGINIA IN 1753 AND AUTHOR OF THESE MEMOIRS IN HIS SEVENTY-FOURTH YEAR

THIS chronicle of the secret struggles—the fortunes and misfortunes—of a pioneer American has been held from public scrutiny for eighty years. Not that its contents have been of a confidential nature, the revelation of which would violate a trust—for it is the frank story of an honorable man—but because the descendants of the chronicler have treasured it as a family heirloom rather than a public document.

It is the life story of a man of strong character and wide experience. It was written by Congressman Walker in his seventy-fourth year for the entertainment of his children and for the information of his direct descendants. It is, however, one of those rare "human" documents that throw back the portals that separate the yesterdays from to-day and lay before the vision a clear view of "America in the rough," when one had to "cut his way through the forests to pass from Virginia into Kentucky," matching his cunning and marksmanship with the half barbarous men, enduring hardships and sufferings that are little known to this generation, and

literally moving the mountains before him.

When one considers that it is but the call of a single generation since the writing of the manuscript here recorded and that this same region is to-day a panorama of thrifty estates, of prosperous institutions, of great centers of commerce and industry—the American Nation seems almost a miracle.

It is living testimony such as this—modest in its narration and wholly unconscious of the possibility of its ever becoming public record and arresting the attention of succeeding generations of fellow-countrymen,—that awakens a full sense of the building of the United States—a masterpiece in governmental evolution.

The chronicler's posterity to-day enrolls many names distinguished in the service of his country—the Bairds of Louisiana and North Carolina, the Grants, Trichelles, Haydens, Bakers, Sawyers, Rollins.

This transcript from the original manuscript is officially presented by permission of Mrs. Estelle Trichelle Oltrogge of Jacksonville, Florida, a great-great-granddaughter of Congressman Walker.

Autobiography of a Southern Congressman

WHEN I proceed to relate the reminiscences of my own desultory walk through life, variable as the winds that incessantly change through the atmosphere, I blush to record the working of the needle in the compass of my mind which has played and vibrated in every direction, like the fool's eyes to the end of the earth. A restless and enterprising anxiety was my constitutional misfortune, which in my later years I most sensibly see and feel, and has lost me half a lifetime of repentance, and, to speak comparatively, ten thousand disappointments.

But to do the same justice to myself, and that I would to others, can acquit myself on the ground that my irregularities were entirely and exclusively my own, and, on the most scrupulous and strict examination, I cannot charge myself in any of my transactions through life, intentionally with malice or fraud aforethought, of doing injury or injustice to my fellow-man. Honesty, truth and integrity has been my guiding or polar star through all the vicissitudes of my variable and checkered life.

An Irish Emigrant in Delaware in the Year 1720

In attempting to give a history or biography of our ancestors, I cannot look back and avail myself of eminent family distinctions as others may do and have a right to do; honest poverty appears to be the lot of our inheritance.

The only honorable title we can claim by birthright, on which I can proceed with certainty, although we might have a claim on the merits of George Walker, a dissenting clergyman who distinguished himself in the wars of King James in Ireland, about the year of 1690, in saving the city of Derry, by his valor and stratagem, when it was thought all was

lost when besieged by the King's troops.

From the information afforded by my father and what I could collect from an old and respectable citizen, Mr. William Smart (an elder of the church in Rutherford County, North Carolina, now deceased) relative to our family descent, states, that my grandfather, John Walker, was an emigrant from Ireland about the year 1720, settled in the State of Delaware about or near a small town called Appaquinimey, lived and died in that State, was buried in a church called Back Creek Church on Bohemia River.

I passed the church in my travels through that country in the year 1796. Mr. Smart related that my grandfather Walker was a plain, honest man (a farmer), in moderate circumstances, of upright character, and respectable in his standing. He, Mr. Smart, made one or two crops with him when a young man. We must suppose he died in the meridian of life. He left two sons and three daughters. The eldest son Thomas died young; my father, the youngest, was bound to the cooper's trade, and followed it some years within my recollection after he had a family.

One of my father's sisters married a man by the name of Humphreys, father of Colonel Ralph Humphreys, who died at or near Natchez about thirty years past, the father of George Humphreys, who lives in that county. One sister married Benjamin Gruble (?Grubb), a respectable farmer of Pennsylvania, but removed to South Carolina and died there. The other sister married Colonel Joseph Curry, settled about five miles below Columbia on the Congaree River. I was boarded there to school in the year 1764 at eleven years old. The schoolhouse stood on the site where Granby is now situated. It was then nearly a wilderness, a sandy desert, and so thinly inhabited that a school could scarcely be made up, and now a considerable commercial town.

On the Borderland With Daniel Boone

Adventures of a Huntsman in Virginia 150 Years Ago

My father, John Walker, after his freedom from apprenticeship, went up the country as an adventurer, settled on the south branch of the Potomac in Hampshire County, Virginia. Being a new country and game plenty, he became a hunter of the first order, famous in that profession, in which he practiced nearly to the end of his life. He was with General Washington in Braddock's Army in the year 1755. Previous to that time he married my mother, Elizabeth Watson, of a good family from Ireland, by whom he had seven sons, no daughter. I was the eldest, born nineteenth day of July, 1753. The names of his sons after my own, were John, James, Thomas, Joseph, George and Jacob. I like to have forgotten William who was the eighth son, although the fourth in succession, and only now living (William, Jacob and myself). After Braddock's defeat, which happened on the ninth day of July, 1775, the country exposed to the depredation of the Indians and in continual jeopardy, my father removed to North Carolina, settled in Lincoln County on Lee Creek about ten miles east of the village of Lincolnton, worked at his trade and hunted for his livelihood according to the custom of the time; game was then in abundance.

About this time the Cherokees, a powerful and war-like nation of Indians, broke out and murdered some of the inhabitants on the frontier. He went out as volunteer against the Indians, joined the army from South Carolina under Colonel Grant, a Scotch officer, marched on to the Cherokee nation (a battle was fought at Estitoe, a town on Tennessee River about fifty miles distant from my own residence) in the fall of 1762. Colonel Grant was there repulsed with considerable loss, yet in the event the Indians were partially subdued and made peace, for a time. It did not

continue long; the war broke the year after.

Plantation Life in the Carolinas Before Revolution

On his return from the expedition he purchased a beautiful spot of land on Crowder's Creek, about four miles from King's Mountain, in the same county, and removed there in the fall of 1763, being then a fresh part; he cultivated some land and raised stock in abundance and I can then remember that my mother and her assistants made as much butter in one summer as purchased a negro woman in Charleston. My father hunted and killed deer in abundance and maintained his family on wild meat in style. I remember he kept me following him on a horse to carry the venison until I was weary of the business, which also gave me a taste for the forest. He resided on Crowder Creek until the year of 1768 the range began to break and the game not so plenty, his ardor for range and game still continued. He purchased a tract of land of four hundred acres from one, Moses Moore, a brother hunter, for one doubleloon, which at this time could not be purchased for five thousand dollars, such the rapid increase of the value of land in half a century. This is the farm and plantation at the mouth of Cane Creek (or second Broad River) in Rutherford County, settled by my father in 1768, on which he resided until he raised his family until they all were grown, and on part of said tract I lived for seventeen years, and had six children born, Betsie Watson, Elvira, Felix Hampton, Joseph, Jefferson and Isabella.

In the year of 1787 my father removed to the mouth of Green River in the same county (about ten miles distant) where he lived until he died on the twenty-fifth of January, 1796, in the sixty-eighth year of his age; left that valuable inheritance of land in the Forks of Green and Broad River to his youngest son, Jacob Walker,

Autobiography of a Southern Congressman

who lives on it to this day. My mother died on Easter Sunday in April, 1808, about the age of 75, and buried by the side of my father in the family burying-ground on the plantation. I trust she was a good woman and gone to rest.

My father bore several commissions under the old government; was colonel-commandant and judge of the court for many years in the county of Rutherford, but on the commencement of the Revolutionary War he resigned all his commissions, both local and military, and united his interests and efforts in defense of his country against the oppressions of the British government and was a member of the First Public Convention held in North Carolina at Hillsborough in July, 1775, on the Revolution of the American States. I was with him at that place. He took an early and decided part in the war, was appointed a regular officer in the Continental Army. His grown sons were all active in that war in defense of their country. He was in person a man of slender habit, full of energy and swift on foot; a suavity in his manners that was graceful and attractive, and a cultivated understanding for his times and his day, and proper enthusiast in his friendship. Among my acquaintances I knew no man of a more liberal, hospitable and benevolent disposition (even to a fault) which often proved injurious to his pecuniary circumstances, but have thought he was wanting in that cool, deliberate, calculating faculty so necessary in all the occurrences of life, to balance the scale of our existence; yet he maintained such a consistency of character as insured him the confidence and friendship of society through life and left a good reputation and inheritance to his children. This is a narrative of our ancestors down to the present generation so far as my information extends.

Early Custom of Binding

Boys into Apprenticeship

At the age of sixteen my father bound me to a merchant in Charleston (Mr. George Parker, an English gentleman of high standing in trade) for five years. He had three prentices of very singular names, one Nancy Milly Stuckings, one Atlard Belin, and myself, Felix Walker (the youngest). He used to boast that he had three young men of such singular names, none such to be found in the city of Charleston in one house, either for names or service. I was highly gratified with my mode of life, well approved by my master, caressed by my mistress, who treated me with the sympathy and kindness of a child. I lived most delightfully for a time while the novelties of the city arrested my mind and occupied my attention.

At length those pleasures began to lag and I became weary and satiated with the continual sameness of the city. My restless and anxious propensities began to prevail and I thirsted and sighed for those pleasures that variety afforded. Some more than a year after being bound, I solicited my master to give me up my indentures and permit me to go home for a time, under promise to return and serve out my apprenticeship. This he absolutely and promptly refused, saying he could nor would not do without me; my father's and my own acquaintance in the country brought in a great custom. At length my father coming to town, I renewed my solicitations to go home and through the influence of my father, and he seeing I was determined to go, he let me off with seemingly great reluctance. In this I believe my father committed an error in taking me away. He ought to have compelled me to business, and have since thought that too much indulgence to a child, particularly in the rise or dawn of life, is the greatest injury we can do them. I have experienced something of this in my own family.

On the Borderland With Daniel Boone

During my residence in Charleston in the Christmas of 1769 I heard the celebrated Dart Whitefield preach with great power. He was the greatest awakening preacher that perhaps ever filled the sacred desk. He had most crowded congregations. I felt the power of the awakening spirit under his preaching, but it soon went off.

Paternal Discipline in the Pioneer American Homes

On my return home my father put me to work on the farm, which did not well accord with my feelings. Yet I submitted and worked faithfully for a while. I applied myself to music, for which I had a predominant taste, and soon acquired a great proficiency in performing on the violin (then called a fiddle) in which I excelled, and although accustomed to frolic, I could never learn to dance. My father, discovering I had neither inclination or capacity for a farmer, he put me to school to Doctor Joseph Dobson of Burke County, from whom I received the best education I have ever been in possession of, although no more than the common English, so-called. I returned from school in less than a year and lived at home nearly two years without much restraint, yet I obeyed my father and mother with the greatest punctuality, but at the same time living according to the course of this world, fulfilling the desires of the flesh and of the mind and of the vanities of life with the greatest avidity. At length, becoming weary of so limited a circle, I solicited my father to suffer me to go to Kentucky (which was then called Louvivy) with Colonel Richard Henderson, who had made a purchase of that country from the Cherokee Indians. He consented, and according my father and myself set out to a treaty held for that purpose, on Watawga in the month of February, 1775, where we met with Colonel Henderson and the Indians in treaty. I there saw the celebrated Indian

Chief called Atticullaculla—in our tongue “the little carpenter.” He was a very small man and said to be then ninety years of age and had the character of being the greatest politician ever known in the Cherokee Nation. He was sent as an agent or plenipotentiary from his nation to England and dined with King George the Second with the nobility, so I heard him declare in a public oration delivered at the treaty. He was an eloquent orator and graceful speaker in his Indian way. The name of “little carpenter” was given him by similitude. The Indians said he would modify and connect his political views so as to make every joint fit to its place as a white carpenter can do in wood. You may find his name mentioned in “Weem’s Life of General Marion.”

The treaty being finished and a purchase made, there associated and collected together about thirty men. Mr. William Twitty with six men and myself were from Rutherford; the others a miscellaneous collection.

Adventures with Daniel Boone in the Wilds of Kentucky

We rendezvoused at the Long Island in Holston. Colonel Daniel Boone was our leader and pilot. Never was a company of more cheerful and ardent spirits set out to find a new country. We proceeded and traveled, cutting our way through a wilderness of near three hundred miles, until we arrived within about twelve miles of Kentucky River when, on the twenty-fifth of March, 1775, we were fired on by the Indians while asleep in our camp; Mr. Twitty and his negro man killed, myself badly wounded, the company despondent and discouraged. We continued there for twelve days. I was carried in a litter between two horses to the bank of the Kentucky River, where we stopped and made a station and called it Boonsborough. I well recollect it was a “lick.” A vast number of buffaloes moved off on our appearance. I saw some running, some loping and

Autobiography of a Southern Congressman

some walking quietly as if they had been driven. It was calculated there were near two hundred.

But let me not forget, nor never shall forget, the kindness, tenderness and sympathy shown me by Colonel Daniel Boone. He was my father my physician and my friend; attended me, cured my wounds, consoled me in my distress and fostered me as his own child. He is no more, has gone to rest, but let me pay my tribute of gratitude to his memory and his ashes.

In a few days after we had fixed our residence, Colonel Richard Henderson, Colonel Luttrell and Colonel Slaughter (from Virginia) arrived with about fifteen men, who stationed with us. This addition, our company consisted of about fifty men, well armed with good rifles. Colonel Henderson, being proprietor, acted as Governor, organized a government. We elected members, convened an assembly, formed a constitution, passed some laws regulating our little community. This assembly was held about the beginning of May 1775. This was the first feature of civilization ever attempted in that flourishing and enlightened state now called Kentucky.

From the recent occurrences of so unexpected an event, my friend and protector, Mr. Twitty, taken dead from my side, myself deeply wounded without much expectation of recovery, brought me to solemn reflections should I be taken off, what would be my destination in the world to come. I could make no favorable calculations as to my future happiness. Under these impressions I was indeed excited to make every possible exertion to meet death, prayed much and formed solemn resolutions to amend my life by repentance should I be spared; but on my recovery, my feelings wearing off, and my duties declining, I gradually slid back to my former courses and pursued my pleasures with the greatest avidity.

Experiences as a Civilizer in Forests of Tennessee

Such is the instability of all human resolutions and legal repentance, no power on earth can change the heart but the omnipotent power of the grace of Almighty God. During the time we were there we lived without bread or salt. In summer, perhaps in July, my wounds being healed, although very feeble I was able to sit on horseback by being lifted up. I set out in company with Messrs. Decker and Richard Hogan and returned by the way we came to Watawga, a dangerous route. It was a merciful providence that preserved us from being killed by the Indians, who were then in open hostilities with all the adventurers to Kentucky. However, we arrived safe to Colonel Robinson on Watawga, and from there in a few days I returned to my father's in Rutherford. I lived at home about three months, when that spirit of novelty began to prevail. I wished to be moving, but what course to pursue was undetermined. At length concluded to go to Watawga, (This river is a branch of Holsteen, heads up in the mountains opposite to Ash County, in N. C.) where I had formed some acquaintances, on my way to Kentucky. And now being my own man (but with the consent of my father) I set out in October '75, and arrived at Col. Charles Robinson's in a few days, being about ninety miles.

The country being newly settled, in a short time they organized a county and called it Washington. I was appointed Clerk of the Court. It was then a county or district of self-government, not incorporated in the State of North Carolina until some years after. It was then taken in by Act of Assembly and so remained until it was ceded to Congress in 1789, and since a part of the State of Tennessee. This was the first Court ever organized in that section of the western

On the Borderland With Daniel Boone

country. I continued in this office for nearly four years.

The war of the Revolution commencing about this time, I considered it a favorable opportunity, a fine theater, on which to distinguish myself as a young man and patriot in defense of my Country.

Accordingly I went to Mecklenburgh County, and meeting with some recruiting officers, by the recommendation of General Thomas Polk (father of Col. William Polk of Raleigh) I was appointed Lieutenant in Capt. Richardson's Company in the Rifle Regiment, commanded by James Stuger (then a Colonel) and was there furnished with money for the recruiting service. I returned to Watawga and on my way throughout that country I recruited my full proportion of men and marched them to Charlestown in May 1776, joined the Regiment, and was stationed on James Island.

Sir Peter Parker with his whole fleet arrived in the Bay while we were stationed on the Island. General Lee arrived in Charleston and took command of the troops, but did not tarry long; he went on to Savannah to assist the Americans against the British and Indians, and to regulate the troops, Sir Peter Parker commanded an attack on Fort Moultrie on Sullivan's Island on the twenty-eighth of June 1776, was repulsed with loss of two British men-of-war and a number of men; did not succeed in the reduction of Charleston.

Ranging the Borderlands with the "Light Dragoons"

The war now becoming general through the American provinces, the British stimulating the Indians on the frontiers, the Cherokees breaking out and murdering the inhabitants of Watawga and Holsteen, where my property and interests lay, I was constrained to resign my commission, contrary to the wish of the commanding officer, and return home to engage

against the Indians in the defence of my property and country.

I was appointed to a command of a company of Light Dragoons to range on the frontiers, was stationed at Nolachuckey for a year and prevented the Indians from making any depredations on the inhabitants.

The war subsiding with the Indians, I returned to Watawga, attended to the duties of my office as Clerk of the Court. Having experienced some of bitter with the sweets of life, I became more local in my disposition. Thinking it necessary to become a citizen of the world, in its utmost latitude, concluded to marry.

Accordingly I was married to Susan Robinson, a beautiful girl of fifteen, on the 8th of January, 1778, daughter of Col. Chas. Robinson (where I had resided for 3 years past). In March ensuing, my wife and self paid a visit to my father in Rutherford, designed to spend the summer. On the 28th of June, my dear girl has a miscarriage, which terminated her existence. She died on the 9th day of July, 1778, six months after our marriage.

This was the most momentous and eventful year in which I lived, through the whole period of my life. I was so shocked and impressed with so unexpected an event, that my mind was almost lost. Absorbed in grief almost insupportable, I felt so deeply afflicted that I thought all my prospects of happiness were buried with the woman I loved. However, happy for man, that in cases of the most deep and deplorable affliction, the constitution of our nature affords some resources for recovery, and finds his way from under the most pressing calamities; but as excess of any kind is not intended to last, after some time I began to collect my scattered faculties and realize what would have been the consequence had I been called off in place of her that was gone, and although it is now 48 years since (1826) that melancholy scene, yet I tremble as I write when I consider

Autobiography of a Southern Congressman

the goodness and merciful forbearance of Almighty God in sparing me to this day, who am a sinner, through all the vicissitudes and vanities of life which I have been destined to fill. To Him be the praise forever, under the alarm of so feeling a dispensation, I became seriously and solemnly impressed with a mighty concern for my own salvation.

Strong Heart of Frontiersman Broken by Death of Beloved One

Reflecting on my past life, I found that I had been traveling from Jerusalem to Jerico, had lived in a state of sin and rebellion against God, ungrateful of his goodness, and trampled his mercies under my feet. I resolved to reform and turn from my wicked ways and be a good Christian, and so ignorant was I that I thought all was in my own power with my good intentions; and but endeavoring to obtain forgiveness for all my sins through the merits of the Redeemer (delusive hope) which I fear thousands are carried away on on the quicksands of their own confidence.

In this resolution I was serious and determined. Accordingly, I read my bible, prayed much, abstained from every evil as I could avoid, declined corrupt company, was sober and reserved in my manners and morals, and so continued until I thought I was not only an almost, but a real Christian indeed, and in truth so I was settled on the fatal rock of self-righteousness, that when the rain descended and the wind blew and beat upon it, it fell and great was the fall; indeed, it swept away the refuge of lies; but glory, honor and praise be to Him who sits on the throne, and to the lamb forever and ever.

I was not suffered to rest on so fatal a delusion; the Lord by his spirit cautioned me that all I have been doing was as filthy rags and then the commandment and sin renewed and the purity and extent of the law was discovered to my mind with irresistible force, and I was constrained to

say "what shall I do to be saved?" The spirituality of Divine Law was as a piercing sword in my back, with condemning power.

This produced a deep sense of the depravity of my nature and pollution of my heart, and my utter inability to save myself by the utmost exertions of my moral powers. In this deplorable and depressed situation, almost to desperation, I remained for a time in inexpressible anguish of spirit, until it pleased the Almighty in His mercy to discover to my mind the way of salvation by faith in Jesus Christ as a Redeemer and Saviour for lost sinners, such as I found myself to be, and at a certain time on a certain day, which was Sunday, I received power to believe in His Name and obtain pardon for my sins to my inexpressible joy and comfort. It appeared to me indeed that old things were done away, and all things become new, or as if I had really been in a new world, for which may I be enabled to praise Him through the ages of eternity; so confident was I at that season of happiness, that I did then believe that all men on earth and devils in hell could through their insinuations never prevail on me to do what I have since done; but since that period my course through life has been such medley of inconsistencies.

Remorse of an American Pioneer and His Resolutions

Could I write in tears of blood the many failures, backslidings and self-indulgences of which I have suffered myself to be the victim, I could not describe the heartfelt inquietudes I have experienced as the consequences; and in truth confess that sinning and repenting has filled up the measure of my days, which I lament and deplore before Him that knows my heart, and regret with the deepest sensibility that I was not more faithful and watchful and grace-given and not permitted the old traitor without, combined with my own traitorous

On the Borderland With Daniel Boone

within, to place me on the dark mountains of unbelief, and left me neither the pleasures of a saint or sinner; but thanks be to Him that opens and no man can shut, who did not entirely abandon and forsake me in that state of double rebellion, but gave me such intimations of His grace as enabled me to maintain a habitual disposition to press forward through fears without and fightings within, and often times like a lost sheep wandering on dangerous ground, has brought me back to the fold again, and by the grace of God I am what I am.

As this narrative of my passage through life may be read by my children while I am mingling with the dust I have trodden for 73 years, I have been more copious on the experimental part (for their encouragement) that if any of them should travel the same thorny road I solemnly warn them of the danger of deviating from the narrow path of rectitude, of virtue and religion. Not to wander on foreign and forbidden ground.

The wages of sin is death, and be assured a man's sin will find him out. If they have been the chief of sinners, so am I; if they are backsliders, so have I been; if they are struggling and striving for victory over a corrupt heart and degenerate nature, so am I, at this time, and have a hope that through the broad righteousness of our Great Redeemer's merits, I shall in the end arrive on the shores of a happy immortality, and (oh transporting thought) if the father and mother, sons and daughters, would be participants of that happy region, what a happy consolation beyond expression to be found worthy.

'With rapturous awe on Him to gaze, who taught the light for me,
And shout and wonder at his grace through all eternity.'

If this be read with the same interest and feeling with which it is written, I trust it will not lose its effect.

Having given a concise view of my times so far, I return to the narrative

as it relates to my further progress through life.

I continued at my father's as a home for about 16 months under the pressure of a wounded and broken spirit, rather in a state of despondency, spending my time without much effect. The war now raging in its utmost violence, I was occasionally with the Whig or Liberty party, though took no commission as I might have had. The county of Rutherford was at this time stricken off from Tyron (now Lincoln County), and made a new county. I was appointed Clerk of Court in October 1779, which brought me into business.

Entering Public Service in First Days of American Politics

After some time, my spirits began to revive and gradually emancipate me from my drooping situation, and viewing myself as a young man and must travel through life on some ground, thought it best to marry and become a citizen of the world once more. Accordingly, after some preliminary acquaintance, I was married to Isabella Henry on the 10th of January, 1780, in the 27th year of my age and 17th of hers, a daughter of William Henry, Esquire, of York, South Carolina. Mr. Henry was a reputable citizen, a plain, honest, reputable character; was a member of the Legislature, and was one of the first settlers in the frontiers of the Carolinas. He raised a reputable family of sons, all of whom took an active part in the Revolutionary War; of a decided military character, invincible courage, feared no danger, and always ready for the most eventful enterprise.

Grandfather Henry (it is asserted) was descended from a wealthy family in Ireland, the only son of his father, who possessed a large estate. His mother dying young, his father married a second wife, and he not liking so well his next mother, eloped from his father about 18 years of age, came

Autobiography of a Southern Congressman

to America and never returned to see for his hereditary inheritance. He settled in Augusta County in Virginia, there married your grandmother Isabella McKown, of a good family. My acquaintance with her enables me to say she was a woman of the first class in her time and her day. She died about the age of 56. Mr. Henry removed to Carolina about 75 or 80 years past, and resided in York District, South Carolina, for 65 years, and died at the advanced age of 102 years, a complete century, which one in ten thousand never arrives to. Thus you have a transient account of both the paternal and maternal line of your ancestors, so far as my information extends; but have something more to relate as respects my further progress through this world, where woods and wild promiscuous shoot, and gardens tempting with forbidden fruit.

I was highly gratified in my second marriage, happy in the woman of my choice, and believe I could not have selected a better had I traveled and traveled till this day. I resided at my father's and father-in-law's alternatively for a while; no place a home, but in camp, the War being so severe and Tories all around.

Driven thro' Wilderness by Enemy in War for Independence

Charleston, S. C., was taken by the British the 12th of May, 1780, after which temporary victory and encouraged by the Tories, they advanced up the country with the greatest rapidity, overran the country in the frontiers of North and South Carolina. Myself with many others were compelled to retreat over the mountains to Watawga and Holsteen in Tennessee for refuge. I took my wife and property with me, and had to take a circuitous route by the head of the Yadkin River through the Flour Gap, by New River to the head of Holsteen, down to Watawga in Washington County, Tennessee, waiting there the event of the War. At length an Army of Volunteers from the West-

ern waters, under the command of Cols. Campbell, Shelley, Sevier and Cleveland, marched through the mountains, joined a few militia from North and South Carolina, under the command of Col. Williams and Col. Hambright. A battle was fought on "Kings Mountain" 1st of October, 1780, where a complete victory was obtained by the Americans, being all militia, over the British Regulars, and Tories, commanded by Major Ferguson, who was shot from his horse, bravely exhorting his men. Seven bullets went through his body, it was said. He was a brave and meritorious officer from Scotland, and it was well he was killed to prevent his doing more mischief.

In February following, the Battle of the "Cowpens" was fought, and a complete victory gained by our troops commanded by Genl Morgan over Col. Tarlton and his legion of horse and regulars. These two victories were a decisive blow to the British arms in that section of Country, and the same fatality pursued them throughout the remainder of the War, until Cornwallis was taken at little York in Virginia, which was the last battle fought between the Americans and British in the Revolutionary War.

Accumulating Wealth in Early Land Speculation

In April 1781 I returned to Rutherford, built a cabin on my father's land at the mouth of Cain Creek. Betsy was born in September 1782. I removed in a year to the mouth of Green River, settled, cultivated my farm and attended to the duties of my office as Clerk of Court, there resided to the year 1787. These five years were my halcyon days, the millenium of my life. I gathered property, lived comfortable with my little family, in friendship with the world and generally at peace with myself.

But, alas, my restless propensity which I fondly hoped was abated, was only slumbering to rouse with double solicitude. A dazzling prospect of

On the Borderland With Daniel Boone

the Western country presented to my view the ten thousand advantages that I might acquire, with such irresistible force, that I resigned my office with a fixed resolution to remove there in a few months.

"Fond man the vision of a moment made,
Dream of a dream and shadow of a shade."

YOUNGE

This was the greatest error I ever committed in my temporal transactions through life. I had considerable property, owed nothing and resigned an office worth \$1,000 per annum. Col. Lewis in whose favor I resigned office, made a fortune worth \$50,000 in thirty years. But being providentially prevented (as I believe) from going to the West, I went down to York District, lived there one year, 1790, returned to Rutherford, purchased a part of my father's old plantation at the mouth of Cain Creek, settled and lived there 17 years. My children Betsy Stanhope, Elvira Watson, Felix Hampton, Joseph Emanuel, Jefferyson and Isabella were born there, after I was settled and fixed in my residence. My acquaintance and intercourse had been and was then very extensive. I had the confidence and friendship of society in general. They put up my name for the Assembly, and I was elected, losing few votes, in the year 1792. The Assembly then sat at Newburn, N. C.

On my return from the Assembly, I commenced merchandise with a tolerable capital, for the country, which prevented me from continuing in the Legislature. I pursued that line of business about 5 years. Went to Maryland and Virginia and purchased several droves of negroes. I was now much in the spirit of the world, and like to have forgotten I was purged from my old sins, but on reflection, collecting my scattered fragments and little remaining strength, abandoned the iniquitous practice of buying and selling human beings as slaves, which I found to be a violation of my conscience, in direct

opposition and in the very face of all morality and religion, and have ever since that conviction abhorred the principle and the practice.

In the year 1795 I engaged in a large land speculation in the Western counties of Buncombe and Haywood, calculated I had made an immense fortune by entering lands. I was not mistaken, and had the line between the United States and the Cherokee Indians been run according to treaty, I would have realized a fortune indeed; but it was run otherwise by the commissioners, and divested me of 10,000 acres of the best land I entered. What I saved I was forced into a lawsuit with Col. Avery for 12 years. Although I gained it, it profited me little, having expended so much money in the defense of the suit.

On Floor of Congress in Early Days of Republic

In the year 1799, I was again elected to the General Assembly by almost a unanimous vote, and continued, with the exception of a few years, to represent the County until the year 1806, which was the last year I was in the Assembly. At length, becoming weary of the drudgery of legislation, I fled from the scenes of popular solicitations and removed to the mountains of Haywood in 1808, warned by the langour of life's evening ray, thought I would house me in some humble shed, with full intention of lasting retirement for the remainder of my life. But, as says a great man, the spider's most attenuated thread is cord, is cable, to man's feeble ties, I consented to have my name announced for Congress. The competition was with Governor Pickens, late Governor of Alabama. He beat me by a small majority. I was then opposed by Judge Paxton. I obtained my election by a good majority, and continued to represent the District of Morgan for six years in succession.

My situation was so enviable that I

Autobiography of a Southern Congressman

was opposed every election, but so feebly as scarcely to be felt.

In the year 1823, Doctor Vance of Buncombe, Genl Walton of Rutherford, Col. Reyburn of Haywood, all offered for Congress. Walton had 978 votes, Reyburn 492, Vance and myself tied at 1913 votes each. The Sheriff of Burk gave the county vote to Vance and elected him. It was well known that Walton and Reyburn bore on my interest. Had Vance and myself met single hand, I should have beat him 1,200 votes; and it was afterwards ascertained I had a majority of 71 votes over Vance, although in counting the ballots they made a miscount or misdeal. The next election my name was announced as a candidate, but on considering my age and growing infirmities, and consulting my feelings which seemed to forbid the bans, I withdrew my name from the list and dropped out of the circle, to the disappointment of the great majority of the District. Such was my standing when I shut the door on public life.

Admitting Missouri, Mississippi, Maine, Illinois into Union

Through the whole course of my life I have been a close observer of providential occurrences, especially as it regards myself and my similar concerns, and do verily believe it was a particular direction of a wise and

unseen Director who knows what is the best for his creatures and cannot err, (by the unexpected event) to arrest my further progress in public life, to save me from some fatality to which I might be liable, and lessen my responsibility in the affairs of State; a gracious donation, to give my few remaining years to retirement, and appropriate the remainder of my days to obtain a better inheritance in a better world.

Since my release from the bondage of serving the busy world, I find myself perfectly regenerated, and so averse am I at the present, that no compensation could induce me to accept of any public vocation.

My standing in Congress is pretty generally known. I took a share in public debates, with what credit society must judge. We must all submit to public opinion. I was one who advocated with the utmost ability the conduct of Genl Jackson in the Seminole War. Also in most of the most interesting and popular discussions, I threw in my mite on the floor—the Missouri questions, the reduction of the army, the Revenue and Bankruptcy bill were all debated in my time. The State of Missouri, the State of Mississippi, the State of Illinois and the State of Maine (4 new states) were admitted into the Union during my service in Congress, under Mr. Monroe's Administration.

A W E D D I N G S U I T I N 1 7 5 6

TRANSCRIBED BY FANNIE M. HACKETT OF BIDDEFORD, MAINE

Jonathan Morrill and Hannah Hackett were married December 29, 1756. This is the receipt for his wedding suit:

SALISBURY Decemr ye 27 A. D. 1756.

This is to Sertify all whom it may Consearn that Jonathan Morrill hath paid Sufficient Bevrage for a Suit of Cloths a Coat of a light Coulourd Drab Cloth with Darkish Satine lining moheir Buttons a full Coat and Briches of Sd Drab and a Jacket of light Couloud bleu Shag Velvet with Tick lining and green moheir and flaned (flanged?) Brass Buttons as witness our hands

DAVID PURINTUN
MOSES ROWELL

Personal Letters of Pioneer Americans

Glimpses into Time-stained and almost Indecipherable Correspondence
Revealing the Strong Character, Conscientious Lives, Domestic Customs, Business Integrity and Courageous Hardihood of First Citizens of the Republic

LETTER SENT BY POST-BOY FROM WILLIAM PRENTISS, DURING THE
PLAGUE IN PHILADELPHIA, TO DOCTOR JEREMIAH BARKER,
FALLMOUTH, CASCO BAY, MASSACHUSETTS, IN 1793

TRANSCRIBED FROM ORIGINAL BY

ABBIE F. CARPENTER OF PORTLAND, MAINE

DESCENDANT OF DOCTOR BARKER

PHILADELPHIA 25th Sept 1793.

DEAR DOCTOR:

I left this for North Carolina last Febry Intending to return in 6 or 8 weeks but was taken sick and did not get back untill last month when I rec'd your Esteemed favour of 1st May last—happy in hearing of yours and Families health, with those of our Dear friends at Gorham—Respecting Mr. Osgood I hope you have pursued him in the law so as to bring him to do Justice—as to my selling his Bills so it was stock in the English I sold it when he Ordered and at market price at the Date—If he can make it appear otherways, I submit—as to too much Interest—he has the amt as I settled it with him and will appear for itself—I believe no Interest is charged untill 6 or 9 ms from Goods being shipped, if not his objections must be futile—However my Dear Sir if you find he is not able to pay the whole—I leave the matter wholly with you to compromise, or settle as shall appear right, so as to bring it to a speedy settlement. I have returned to this City about one month, since which time the heaviest Judgments have attended us—about 20,000 citizens have moved out and the rest are Dying by hundreds—for 15 or 20 Days past have been buried from 30 to 50 of a day and some days upwards of 100—All Stores and Business are to stop and all communication cut of from the Country—and between this and New York, Baltimore &c.—what alarms us more is a proper war between the principal Physitions some calling and Treating it as of a Putrid nature—others as wholly Inflammatory—however as it is most that are taken Die—some in 3—4—5 to 8 days which none scarcely exceed except they recover—From the Symptoms &c I have no doubts of its being the Plague—it is traced being Introduced by a Vessell with Passengers from Ireland. The Yellow Fever never could spread from a Country whose lattitude is 53 and that surrounded by Salt Water—Its the Plague—but the reason its not so general here as in Old countries, is—we have Spacious streets that are kept clean and of course have always a free and clear circulation of air—we have clean Houses and not crowded—In those countries where this fatal disorder generally sweeps whole cities as it where They are quite the reverse—To add to our Calamities the commissions have return'd without concluding the Treaty with the Indians. Therefore we may expect a Bloody Indian War—God only knows how our distresses will end—we are in the hands of a merciful being, and while his Judgments are abroad in the land may the Inhabitants learn righteousness and be humble.

We intended to have left the city but one thing and another has hindered us—and now I fear we are shut in—

My Brother Saml mentioned to me about finding a Vessell with sundries to No. Carolina—tell him if e can send one with suitable articles—such as his crockery—Beef—home cloth—West India Goods &c. to Plymouth Roanoke River No.

Personal Letters of Pioneer Americans

Carolina I think Henry could do well for him Corn, Pork, Pease, Tar &c—but he must get his Vessell on low Terms—If Caleb is with him tell him I will write him by first private conveyance—Henry keeps store up the River above Plymouth—but Plymouth is the place Vessells load at—please to give Our most affectionate Love to them and Brother Gorham's family—Sister Bacon if with you and accept the same to you and yours—with every Good wish for your Healths and Happiness.

WM. PRENTISS.

I send this by Post—the expense shall be happy in Refunding when I see you—which hope will be in course of next Winter or Spring.

LETTER WRITTEN TO REVEREND CHANDLER ROBBINS OF PLYMOUTH, MASSACHUSETTS, BY REVEREND LITTLE IN BIRMINGHAM, ENGLAND, DISCUSSING THE MORAL PROBLEMS IN 1797

TRANSCRIBED BY

MRS. LYDIA J. KNOWLES OF BANGOR, MAINE

“BIRMINGHAM MARCH 7 1797

REVD. & DEAR SIR:

Upon reviewing your letter of Oct 7 1796 I feel regret that I have suffered twelve months to elapse without sending a line to so kind a corispondant. this I did not intend to do last fall when I spent six weeks at Plymouth but could find no ship during that period bound to Boston.

I should be ashamed to trouble you with so many queries concerning Dr. Hopkins's System &c did I not feel persuaded that your kindness and readiness to communicate would not even find a sort of gratification therein,—For which you are entitled to my thanks. Some of your answers have removed my objection from the Dr. and others have confermed me in the opinion that good men from different habits and modes of reasoning may think very differently yet very sincerely on the same subject. I doubt not a great part of the felicity of heaven will result from the clear unobstructed views we shall have of Divine truth. Every difficulty will then be cleared up—and full evidence of the glorious propriety and consistency of the moral government of Jehovah will blaze on every mind. Hence the perfect union of the assembly of glorified Saints.

It will be one indivisible—harmonious—blessed society—without a discordant Word or Idea! My soul longs for that perfection! and I would say with the psalmist 'Then shall I be satisfied when I awake with thy likeness!' But while this happiness is withheld, O! for grace to supply in brotherly affection what is deficient in understanding.

I would not forget to tell you what little evangelical Intelligence I have to communicate. The missionary Society have compleated their first mission To the South Sea Islands.

In a few months the subscription amounted to Thirteen Thousand pounds, a striking proof that the hearts of all men are in the hands of the Lord. The silver and the gold of the earth are His! nor can be better appropriated than as a sacrifice at the gospel shrine. Men were not more difficult to procure than money.

Several came forward and offered themselves to embark in the arduous undertaking of carrying the news of Salvation by our precious Emanuel to a perishing heathen World! A ship called the Duff was purchased last year by the Society and fitted out and stored by the voluntary contributions of benevolent individuals. The spirit which appeared on this occasion was Singular. A ship-wright employed in fitting the ship for her voyage, whose work could not be estimated at less than 200 pounds Stirling, made a formal charge to the directors of the Society of 5 shillings for the whole business.

Personal Letters of Pioneer Americans

A gentleman gave a table worth 200 pounds and hundreds of private families contributed lots of smaller articles such as linnin—hardware—Books—pickels and evry other necessary and convenience for so long a voyage. A pious man who had been a Capt in the east Indian Service twenty years—but had retired in affluence to spend the remainder of his days in ease at home—was drawn forth by the attractive influence of so noble an undertaking, but still more (we trust) by the love of Christ, to offer himself to conduct the expedition. His piety—sensibility and sweetness of disposition endeared him to the Directors and Missionaries. His nephew, an agreeable serious young man accompanied him as Chief Mate. The whole ships crew were selected from professing *Christians*. The mission consists of 27 men not all of them preachers, but some of them intended to assist as mechanics in the intended settlement. But *all* of them as far as human understanding can judge, partakers of ardent love to Christ, and unconquerable desire for the salvation of immortal souls,—*five godly women* wives of some of them—and 3 *infant children*: 37 persons in all, there sailed from Spit-head on Thursday 22 of Sept 1796—and were bound to Otaheite.

It is the intention for the whole mission to stay in that Island 3 months till they have formed a good notion of their language, customs &c and obtained a peacablè footing among the natives—after which as many as can be spared are to remove to adjacent Islands, of which the language is precisely the same. I feel no small gratification in having among this truly honourable Company—two young men—the fruit of my ministry—and one of whome continued under my care sometime previous to embarking in this work. You will doubtless unite your prayers with Thousands in this land for a blessing on this important undertaking! This bread of Life is cast upon the waters—We need persevering faith prayer and patience to waite and it shall be seen after many days! All the promises and prophecies are in our favour. God has long said to the *North* give up—He will also say to the *South*—keep not back! Great obstacles are indeed in the way.”

LETTER SENT BY GEORGE WASHINGTON IN 1797 TO HON. OLIVER
ELLSWORTH, A FRAMER OF THE CONSTITUTION, MINISTER
TO FRANCE, AND CHIEF JUSTICE OF THE UNITED STATES

TRANSCRIBED FROM ORIGINAL BY

ADALINE B. ELLSWORTH ROBERTS OF OLLANA, ILLINOIS

PHILADELPHIA, 8th Mar. 1797.

DEAR SIR:

Before I leave the city, which will be within less than twenty-four hours, permit me in acknowledging the receipt of your kind and affectionate note of the 6th, to offer you the thanks of a grateful heart for the sentiments you have expressed in my favour, and for those attentions with which you have always honored me. In return, I pray you to accept all my good wishes for the perfect restoration of your health, and for all the happiness this life can afford. As your official duty will necessarily call you to the southward, I wish to take the liberty of adding, that it will always give me pleasure to see you at Mount Vernon as you pass and repass, With unfeigned esteem and regards, in which Madam Washington joins me, I am always and affectionately yours

G. WASHINGTON.

The Centenary of an American Poet

Henry Wadsworth Longfellow—Born at Portland, Maine, February 27, 1807—Died at Cambridge, Massachusetts, March 24, 1882

The Poet Longfellow frequently remarked to his friends that a Man's Work is his best memorial—On this Centenary of the Poet four of his Sonnets, two of which are translations from that Master-Artist Michael Angelo, are here inscribed to his memory

I

OLD AGE

From the Italian of Michael Angelo

The course of my long life hath reached
at last,
In fragile bark o'er a tempestuous sea,
The common harbor where must rendered be
Account of all the actions of the past.
The impassioned phantasy, that, vague and
vast,
Made art an idol and a king to me,
Was an illusion, and but vanity
Were the desires that lured me and
harassed.
The dreams of love, that were so sweet of
yore,
What are they now, when two deaths
may be mine,—
One sure, and one forecasting its alarms?
Painting and sculpture satisfy no more
The soul now turning to the Love Divine,
That oped, to embrace us, on the cross its
arms.

III

BURIAL OF THE POET

In the old churchyard of his native town,
And in the ancestral tomb beside the
wall,
We laid him in the sleep that comes to
all,
And left him to his rest and his renown.
The snow was falling as if Heaven dropped
down
White flowers of Paradise to strew his
pall;—
The dead around him seemed to wake,
and call
His name, as worthy of so white a crown.
And now the moon is shining on the scene,
And the broad sheet of snow is written
o'er
With shadows cruciform of leafless trees,
As once the winding sheet of Saladin
With chapters of the Koran; but, ah!
more
Mysterious and triumphant signs are
these.

II

FIRE

From the Italian of Michael Angelo

Not without fire can any workman mould
The iron to his preconceived design,
Nor can the artist without fire refine
And purify from all its dross the gold;
Nor can revive the phoenix, we are told,
Except by fire. Hence if such death be
mine
I hope to rise again with the divine,
Whom death augments, and time cannot
make old.
O sweet, sweet death! O fortunate fire
that burns
Within me still to renovate my days,
Though I am almost numbered with the
dead!
If by its nature unto heaven returns
This element, me, kindled in its blaze,
Will it bear upward when my life is fled.

IV

MY CATHEDRAL

Like two cathedral towers these stately
pines
Uplift their fretted summits tipped with
cones;
The arch beneath them is not built with
stones,
Not Art but Nature traced these lovely
lines,
And carved this graceful arabesque of
vines;
No organ but the wind here sighs and
moans,
No sepulchre conceals a martyr's bones,
No marble bishop on his tomb reclines.
Enter! the pavement, carpeted with leaves,
Gives back a softened echo to thy tread!
Listen! the choir is singing; all the birds,
In leafy galleries beneath the eaves,
Are singing! listen, ere the sound be
fled,
And learn there may be worship without
words.

"THE SOUL NOW TURNING TO THE
LOVE DIVINE,
THAT OPED TO EMBRACE US. —"



LONGFELLOW

CENTENNIAL BAS RELIEF—1807-1907
BY LOUIS A. GUDEBROD, MEMBER OF THE
NATIONAL SCULPTURE SOCIETY—EXECUTED FOR THE
INAUGURAL NUMBER OF THE JOURNAL OF AMERICAN HISTORY AS A MEMORIAL
TO THE POET OF THE AMERICAN HEART ON THE ONE HUNDREDTH ANNIVERSARY OF HIS BIRTH

64

Philosophy of Death in Early America

Manuscript by

the Reverend Joseph Webb *

Born in 1666 and an Intellectual and

Moral Leader of His Times * Occasioned by the

Demise of Major Nathan Gold, in 1693, who was foremost in

Political, Military and Ecclesiastical Affairs * Original Sermon Transcribed

BY

MRS. ELIZABETH HUBBELL SCHENCK

WASHINGTON, DISTRICT OF COLUMBIA

"Strange, is it not, that of the myriads who Before us passed the door of Darkness through,

Not one returns to tell us of the road,
Which to discover we must travel too?"

THE mystery of death is one of the few problems that civilization fails to solve. The first philosophers argued its perplexities only to come, like the wise Socrates more than four hundred years before Christ, to the conclusion: "We go our ways—I to die, and you to live. Which is better, God only knows."

Not until the writing of that wonderful scroll—the scriptures—in which is embodied the fundamentals of all sciences, has light been thrown onto the bleakness of the hereafter, and these revelations while establishing hope and faith in a life to come, veil death with a mystery that centuries have been unable to lift.

The six thousand orthodox years since the creation find theologians and scientists still parleying over the disposition of man after he has left this earth. That death is the emancipation of the soul and that it rises to the light of eternal life is the view of the orthodox world, supported by multitudinous evidences.

That even the orthodox view of death is subject to a continual process of change, and that its dire terrors are being illuminated with the light of reason until its beautiful aspects are

more discernible, is shown by a comparison of the funeral orations of the church to-day with those of the earliest in America.

In possession of Mrs. Elizabeth B. Gould of Fairfield, Connecticut, is the original age-seared manuscript of the funeral sermon preached over the remains of Major Nathan Gold, a leading citizen of his times, for fifty years a compatriot of the Burrs and the Ludlows, foremost in ecclesiastical, political and military affairs, and the progenitor of the Gould family in America, one branch of which has become eminent through its accumulation of great riches and the philanthropy of one of its daughters. Major Gold died on March 4, 1693, and the funeral sermon here recorded was preached by the Reverend Joseph Webb, eminent for his scholarship and as a theologian.

While this sermon with its quaint diction and construction is an interesting study in homiletics, its real worth is as a witness of the thought and spirit of its generation, revealing the tendencies and leading characteristics of the age and life of which it was a part. It views death as a calamity—as a rebuke from God—and there is in it an eccentric strain of perplexity that a pious man should die. It is here presented as a basis for the study of the intellectual and religious movement in America, especially in relation to the final disposition of mankind.

Sermon by an Eminent Theologian in 1693

THAT we are at this day under ye terrible rebukes of God; that God hath not only formerly but now very lately written bitter things agst us in this place. I suppose none of us are ignorant. Tis to be feared, all are not soe affected with or circumstances as they ought to be, and as it could be wished they were, but none can be all-together without ye knowledge of them. It seems to be a day wherein ye Lord is calling us to weeping, mourning, boldness and girding on of sackcloth. The Lord hath bin bespeaking this from us by ye loud voice of an awfull and solemn providence, in wch he hath bin striking a very dismall blow at or head and hath made a very sorrowfull breach there. Wt is ye duty of the day hath bin well and very pathetically laid before us by a pious and faithfull Servant of Jesus Christ from yt text I Samll: 25, 1. And Samuel died and all ye Israelites were gathered together and lamented him and buried him in &c.; And oyt there were such an heart in us to practice according to wt was from thence soe solemnly and affectionately pressed upon us as or duty. This is ye best way to prevent further wrath from coming upon us here and to provide for a comfortable account of wt we yn heard in ye great day.

Considering yt we cannot be too well acquainted wth or duty at such a time, I was willing (according to ye small mite received) to endeavr wt might be for or further information and instruction. Such a providence as this, I could not by any means silently pass over,—but would take such notice of it as to endeavr some spirituall improvmnt of and benefit by it. And wt we shall say will be from ye words now read unto us, which hold forth an account of ye sickness and death of a great and good man together wth ye effect it had upon a person of great dignity and honour.

(1) There's observable ye sickness and death of a great and holy man "Now Elisha was faln sick of ye sickness whrof he died &c.; Ye person we see is here described by his name Elisha, he was a man of great note, one in a publick capacity, or of publick use and place. Tis true his office and sanction was sacred, he was a prophet, but wt is here said concerning him is very applicable unto those who have a civill charge committed to them. It is a truth as well concerning godly magistrates as ministers yt they are liable to sickness and death, and yt they are ye chariots of Israel and horsemen thereof, wch are ye things we design to speak to. Thus for ye person. As to his sickness it is not particularly expressed wt it was, but wt ye kind of it be wt it will, it seems it was mortall, it had malignity enough in it to kill ye animall spirrits and to cause a seperation between his soul and body, it was (as ye text saith) his sickness whrof he died.

(2) Here's allsoe observable ye effect it had upon a person of honour. And Joash ye King of Israel came down and wept over his face and he said o my father my father &c.; (1) The person is described from his name Joash; (2) From his office, he was King wch is amplified from his subjects wch he more werthy reigned over. Israel 1c ye ten tribes; (3) Here's ye effect it had upon him. viz. it brought him to see him and to weep over him &c. It's said he came down unto him &c. The names of ye prophets' sickness brought him from his palace, from his castle to pay him a visit and ye prospect of his death drew tears from his eyes (1) he wept over his face, partly because he loved him, and partly because of ye great loss his death would be to ye Kingdome. (2) Here's ye lamentation he broke forth into, o my father, my father, ye chariot of Israel and ye horsemen yreof [before we come to ye observations designed it will be necessary to hint at ye meaning of

Philosophy of Death in Early America

those phrases O my father my father] thus he calleth him out of love, reverence and respect; but assuredly tis not a bare and empty complement, yre is a great deal in it, he was a father to him and all ye people, as godly ministers and magistrates are as we may hear afterwards.

(The chariots of Israel and ye horsemen thereof.) there were chariots of war and yre were chariots of State in a time of peace; not only such as were for ye defence of a land, but allsoe such as were for ye glory and honour of great men. 2. Samll: 15.1. And Absalom prepared him chariots &c.; i e for his greater honour and dignity. The expressions are metaphoricall and signific yt Elisha was ye glory, strength and power of Israell. The strength of a people in war lay most in chariots and horsemen they are as it were ye strength and stay of ye land, soe are pious rulers either in church or State, and the interpreters expound ye phrases only concerning ye security, stay and defence of a people yet inasmuch as ye words will well bear wthout ye least straining ym ye other interpretation viz; concerning ye glory and honour of a people we shall add this allsoe in or discourse from ym.

1. Doct. yt Pious men of publick use and place must die as well as others. 2. Doct. That pious and holy men especially those who are in a publick capacity are ye fathers, the glory, and the strength of a people among wm they live and over wm they are, O my father, my father ye chariot of Israel &c.; 1. Doct. Holy men of publick use and place must die as well as others. Such are no more exempted from this stroke yn others. The godly are indeed delivered from ye sting of death, but not from ye stroke of it. Neither goodnes, nor greatness is sufficient to procure for any a discharge in yt war. 8. Eccl: 8—yre is noe man yt hath power over ye spirit to retain ye spirit; neither hath he power in ye day of death: and yre is noe discharge in yt war, and as he ads

in ye last clause of ye verse, neither shall wickednes deliver those who are guilty of it, for it may be said neither can righteousnes prevail unto this. Good men tho never soe usefull to, tho never soe much loved and respected by those among wm they live must sooner or later away to ye grave. Godly rulers must die tho eminently holy and serviceable unto yr people. It hath bin soe; it is soe, and will be soe. Wt is become of Moses, of Joshua, Samuel, David, Josiah and of many other worthies, great and good men who have served God and yr own generation according to ye will of God? Why! they are long since dead. The Scriptures wch record ye entrance into, and ye behavior in, this world have allsoe recorded their exit out of it. 34. Deut. 5. Soe Moses ye servt of ye Lord died yre in ye land. 24. Josh. 29. And it came to pass after these things yt Joshua ye Son of Nun ye Servt. of ye Lord died, and 1. Sam: 25:1. 1 Kings 2.10. and 2 cron: 35.24. Hence we see yt it hath bin thus, and yt it is thus by an awfull and sad instance among ourselves; and soe it shall be soe hereafter.

And yn doe those yt minister about holy things fare any whit better? Are ye Servants of God in ye ministry any more exempted than his servants in ye magistracy? Where are the ancient prophets and teachers of God's church? They are long since gone to ye place of silence. Elisha must die as in ye text, and ye rest of ye prophets have submitted to death. 1. Zech: 5. Yor fathers wre are they? and ye prophets doe they live forever i. e. they doe not, they are dead and gone to yr long home as well as other men. But I need not enlarge to confirm a truth wch is verified by soe many dayly instances.

If we enquired after ye reasons of it, why and whence is it yt pious magistrates and ministers must die as well as others. Answ. (!) It is because they are under ye Same condition and circumstances of mortality wth other

Sermon by an Eminent Theologian in 1693

men. That wch is the cause of the death of others is to be found wth and is extended even unto ym and yrefore yre is noe discharge for ym in this war, any more than for others. See ye illustration of this in three particulars. 1. They are of ye same earthy and compounded constitution with other men. This is the internall cause of man's mortality vizt ye composition of his body. It is made up of contrary elements and qualities wch are continually warring one agst another and will continue soe to doe untill ye controversie be decided by ye destruction of yt wch is thus compounded. This is ye condition of all bodies, they are made of earth, dust &c., hence tis said of men in generall yt they dwell in houses of clay and yt yr foundation is in ye dust. 4. Job. 19. and this is yre laid down as a reason why they are soe frail and brittle, soe exposed to death, soe easily crushed before ye moth as ye phrase yre is. Good and great men are made of this matter as well as others. Such an one as Abraham could say concerning himself yt he was dust and ashes. 18: Gen: 27. The honour wch men are advanced to here doth not refine yr natures, soe as to diminish yt dreggishnes wch is ye inward cause of mortality. Neither doth conversion and holiness make any physicall change in men. Grace doth not physically but only morally alter yr natures. Soe yt seing great and good men are of ye same constitution wth othrs wch is a cause of yr death, it must needs be yt they be mortall like them. (2) They have had to doe wth Sin as well as others and therefore are mortall as well as they. Sin is another cause of mans being under a necessity of seing corruption. Sin wch hath brought death into ye world. Death was first threatned unto and in case of Sin. 2. Gen: 17. This hath invited death into ye world, and this is given as ye reason why all must come under ye reach of death vizt because they've touch'd ye unclean thing, Sin. 5. Rom: 12. wherefore as by one

man sin entred into ye world and death by sin and soe death passed upon all men, because all have sinned. If any say hath not Christ died for believrs why yn must they die, should they not have a discharge yn upon his acct! I answr they have a discharge from ye sting of death, from death as a curse: they die not to satisfie justice in part for yr sins as Christhes sinnrs doe, but they have sinned since yr being in Christ and there is of ye leprosie of sin cleaving unto ym and yre it will be untill it be abolished by ye taking down this earthly house of ye tabernacle. Therefore 'tis noe unrighteous thing for God to subject ym unto ye stroke of death.

Pious magistrates and ministers must yrefore die as well as other men, because they have sinned as well as others. (3) They are under ye same law of mortality with other men. Death is established by an irrevocable decree. There is a statute law of heaven concerning ye progress of death, and by this law all are doomed unto this stroke 9. Heb. 27. It is appointed for men i. e. all men once to die. Now as they are men tho they are holy and honourable they come under ye force of this law, and are by it obliged to pay this debt unto nature.

(2 Rea:) Great and good men must die as well as others yt soe they may give up yr account. The great God stands in ye relation of a judge unto all ye Sons of Adam. He hath brought ym under a law, and hath betrustrd ym wth such and such talents according to his pleasure and hath required such and such an improvemt of ym. Accordingly he hath laid ym undr a necessity of being accountable to him for wt they have received and done. And even godly rulers both in civill and sacred respects come under this obligation. Those yt are in civill authority have yr power from God, he calls ym to ye places they are in, and betrustrs ym wth ye power they have 13. Rom: 1. For yre is noe power but of God,

Philosophy of Death in Early America

hence they are said in ye execution of ye office to act for God. 2 Cron: 13.6 —for ye judge not for man but for ye Lord.

And yn as to ministers they are said to be stewards of God. 1. Tit. 7. wch supposeth ym under an engagemt to give up an account of wt they have bin and received. And this account is refered unto ye other world, there it is to be given up. Therefore these men must die as well as others yt soe they may make yr appearance before ye great judge, and be accountable for wt they have done in ye flesh 9. Heb. 27. Judgemt is yre to follow imediately after death. (3 Rea.) They must die that soe they may rest from ye labour and toil appointed ym in this world. All men have work to doe in this world. They have a task set ym by ye God of heaven. They have something to doe for soul and body, for time and eternity, for ym-selves and others, and this labour wch is commanded ym is not without its difficultie. But these who are in a publick capacity, who have ye charge of the civill or sacred concern's of a people have a much greater burden to bear than others. They have very often hands full and hearts full wth ye publick charge and truse comitted to ym. They have besides yr own particular burden ye burden of yr own personall concerns, the burden of yr own families, they have ye burden of ye comon wealth, and of ye church lying upon ym. And o how much trouble and sorrow and difficulty doe they meet wth from those things! How often are yr hearts ready to break and yr spirits ready to die and sink under ye weight of those perplexities and troubles wch are occasioned unto ym by yr concerns wch they are to manage?

Now they must not be allwayes staggering under such weary loads. Their case would be miserable indeed if it were to be soe wth ym allwayes. Therefore God hath appointed ym a resting time and place. And wre is this? Is it not in ye grave 3. Job. 17.

—there ye weary be at rest. yr ye bod-ies of ye righteous lie at ease and quiet. And yr souls are imediately upon yr death carried to ye rest in Abrahams bosome 16 Luk 22. Hence ye dead yt die in ye Lord are pronounced blessed upon this acct and from ye time of death they rest from yr labours 14. Rev: 13. And I heard a voice from heaven saying unto me write blissed are ye dead wch die in ye Lord from henceforth yea saith ye spirrit yt they may rest from yr labours &c.,

(4 Rea:) Holy men of publick use and place must die that soe they may receive yr reward Tho none deserve or merit a reward for wt they doe, yet God hath of free-grace promised a reward to those who faithfully discharge yr trust. He will not be served for naught. He hath a sure recompence of reward for pious ones, especially for holy magistrates and ministers. God is not unrighteous to forget yr work and labour of love as ye phrase is in ye 6. Heb. 10. By this we may see yt they must be rewarded. And now they are not recompensed in this world. Here they are oft abused for ye love and service, here they meet wth scorn, contempt and reproach, are evill spoked of. Moses and Aaron were abused by Cora and his company 16. Numb. 2. And others have met wth ye like evill treatment. Jeremiah met wth soe much as yt he was ready to exclaim agst his mother for bringing him into ye world 15 Jer: 11. woe is me my mother yt thou hast born me a man strife, and a man of contention to ye whole earth—every one of ym doth curse me. And Paul will tell us yt he was accounted as ye off-scouring of all things. 1 Cor: 4.13. we are made as ye filth of ye world &c.;

Their reward is yrefore in ye other world and they must die yt soe they may have it. It is given ym after yr death 14. Rev. 13. and yr works doe follow ym, yr works, ie. ye gracious reward of yr trouble, hardship and patience.

Sermon by an Eminent Theologian in 1693

(5. Rea.) Holy men of publick use and place must sometimes die to make way for ye wrath of God to come down upon a sinfull people. The death of pious rulers is allwayes in mercy to ymselves and sometimes it is in judgmt unto ye places where they lived. The death of such eminent ones is a presage of approaching calamities, in ye 57. Isai 1. it's said yt ye righteous are taken away from ye evill to come. God is wont to take such away before he brings, and yt soe he may bring an overflowing Scourge upon a degenerate and irremediable generation. Whilst they lived they were a means to keep off judgmts. God could not to speak after ye manner of men soe freely and fully pour out ye vialls of his wrath upon an impenitent and sinfull people whilst they lived, and therefore they must be carried to ye grave yt soe he may have ye greater liberty to accomplish ye ruin of such as would by noe means be reformed. See this illustrated in 2. particulars. (1) They are taken away by death that soe they may not see and be grieved for those miseries wch come upon those amongst w^m they lived. Tho. God's servants in ye magistracy and ministry may meet with ill treatmt from, yet they are truly sollicitous for ye wellfare of yr people. And it would be a sad and grievous thing to ym to see ym ruined. To see these and those dismall calamities overtake ym would be an heart breaking sight to ym. To see yre land in wch they dwell wasted and emptyed of its inhabitants by mortall sicknes, by ye sword &c., To see yr neighbors perishing by famine, pestilence and sword, how would it even grieve yr very souls to death! How doth pious Esther express ye intollerable grief yt ye destruction of her people would be unto her 8. Esther 6. For how can I endure to see ye evill yt shall come upon my people! or how can I endure to see ye destruction of my Kindred, as if she had said I shall not be able to see it for grief. Now God doth

not delight to grieve his children, nay he will avoid it as much as may be soe yt wⁿ such terrible judgmts can be noe longer deferred, he sends death to fetch home such precious ones yt they be out of ye noise of them. God knew how bitter a cup it would be to good Josiah to see ye ruine of Jerusalem, destruction of ye temple and captivity of the people and therefore he gives him a gracious promise yt he should goe to ye grave before these judgmts overtook them. 2 cron: 34. 28. Behold I will gather thee to thy fathers in peace and thou shalt be gathered to thy grave in peace, neither shall thine eyes see all ye evill yt I will bring upon this place and upon ye inhabitants of ye same. (2.) They must die that soe they may not by yr intercession for a sinfull land any longer retard those judgmts wch they have deserved and God is now resolved to bring upon ym. They are ready to pity and compassionate ye case and condition of a sinfull people. These righteous ones are earnestly desirous of ye wellfare of yose among w^m they are and wⁿ they see evill coming upon ym and in a probable way to fall upon ym, they cannot but endeavr to yr utmost ye preventing of it: Wⁿ God is threating, a sinfull generation they will interpose as far as they may wth God on ye behalfe of those who are threatned. noe unkindness of a People towards ym shall put a period to their prayers for ym. The people of Israel were unkind to Samuel in rejecting his governmt, and asking a King, but yet he resolves not to cease praying for ym 1. Samll: 12:23: moreover as for me God forbid yt I should sin agst ye Lord in ceasing to pray for you. And o how earnestly will they plead wth God for ye sparing of sinners! How hard did good Abraham plead for poor Sodome See in ye 18. Gen from 23 vs. to ye end. And tho ye destruction of it was not prevented yet it may be remarkt yt soe far as Abraham requested God granted. And assuredly ye prayers of Gods emi-

Philosophy of Death in Early America

nent Servants have a great deal of efficacy to keep of wrath from a people. Lots prayr procured ye salvation of Zoar from yt generall destruction wch came upon ye other cities about it. 19. Gen 20.21.—And he said unto him See I have accepted thee concerning this thing allsoe, that I will not overthrow this city for the which thou hast spoken. God is unwilling to loath to deny ye prayers of his dear ones. The prayers of his eminent servants doe (wth holy reverence be it spoken) as it were tie ye hands of God. Therefore he takes ym away sometimes by death yt he may not be hindered by yr intercession from cutting down a generation of sinners. Wn God is resolved yt wrath shall come he stops ye mouths of those praying ones, that those shall not pray whose prayers would have bin an hindrance to him in his designs.

APPLICATION!

I vse. Is it soe yt pious men of publick use and place must die as well as others, let this teach us to beware of having too great a dependence upon any, yet greatest and best of men. Men may indeed be both able and willing to doe us a kindnes in this or ye other respect whilst they live, but we must not depend overmuch upon ym, because of the mortality of yr lives. It is indeed lawfull and a duty to value ye friendship of great and good men, but it is of interest to remember and considr that they are but dying friends and soe to be cautious of laying too great a Stress upon ym. Upon this consideration ye Lord endeavors to take off or confidence from men because they are mortall creatures. 2. Isai. 22. Cease ye from man whose breath is in his nostrills for wherein is he to be accounted of! As if he had said yre is but little help to be had from these. ye hear yt great ones are mortall yrefore put not yor trust in men whose breath and life is in yr nostrils; Stop but yre mouth and nose and they must die imediately. Wrein is he to be accounted of" ye meaning is wt is there I pray in man

for wch we should put or trust and confidence in him? he is nothing at all. We are advised in ye 146. Ps:3. not to put or trust in Princes nor in ye sons of men and ye reason is given in ye next vs. his breath goeth forth and he returneth to his earth.

(2) This truth teacheth us yt 'tis ye great interest of a people to be continually praying unto God yt he would raise up and qualifie others to succeed in and to fill up ye places of those publick men whom he from time to time calls out of ye world. Great and good men we heare are mortall as well as others, or Godly magistrates and ministers who have ye care of or all are dying and must die. This we are not only told of from ye word of God but have allsoe bin informed of in the providence of God, wch hath not only formerly but more lately sealed this truth to us. Now are not such men of great use? Can a people be in any tolerable degree happy without them? Wt will become of or bodies and or souls without such publick persons. It will be sad if wn God hath called any of his worthies in church and state their places must stand empty, and there be none to step forward to make good yr ground. Now if we would have this prevented we must follow God wth dayly and earnest prayers, that he would suitably fit and qualifie those yt are rising up not only wth naturall but allsoe wth gracious abilities for wtever service for himself and for his people they may be now or hereafter called to. God only can Spirrit and fit men for a publick (wch is a very weighty) charge either in civill or Sacred respects. God is acknowledged as ye authr of yt Knowledge and gifts wch meetens ym for curious work of ye hand &c; 35. Exod. 35. Much more are gifts and graces to qualifie for a charge of a more publick nature from him. And prayer is needfull to obtain and procure this pouring down of his Spirrit, upon those who are to be ye Successrs of or pious magistrates and ministers yt goe off ye Stage at

Sermon by an Eminent Theologian in 1693

this and ye other time. Let us dayly yn pray hard that we may have Joshua's to succeed or Moses's, that we may have Solomon's to succeed or Davids, yt we may have Elisha's to make good ye ground of or Elishas when they come to leave us. This is the way to have or comonwealth and

or churches to flourish, to our owms and or posterities wellfare and happiness, both for time and eternity.

(3) And lastly If godly magistrates and ministers must die and are dying, let this teach us to secure ye friendship and presence of an unchangeable God.

ANECDOTE OF AN AMERICAN REVOLUTIONIST

BY MRS. J. R. COZART OF LAMAR, ARKANSAS

I RECALL these statements made to me by my husband's father, Sidney Bumpass Cozart, which he said, he obtained from his father, James Bumpass Cozart, prior to his death which occurred September 17th, 1846.

James Bumpass Cozart's father's name was Anthony Cozart, who lived in Orange County, North Carolina, his occupation was that of a planter; he married Winnifred Bumpass, a sister of John Bumpass, who was captain of a company raised perhaps in 1772, or 1773, to demand some redress from Governor Tryon. Anthony Cozart was a member of this company, which assembled at his (Cozart's) house, moulded bullets and discussed the methods of procedure.

These deliberations were not to be made public until a stated time as they might be considered insurrectionary by Governor Tryon, but the news

reached the governor who made preparations and dispersed them. Captain Bumpass was arrested and sentenced to death, but from some cause was not executed. Tryon then sent men out, whom the people called "Press gangs," to take the arms of all engaged in this movement, but Cozart's wife, by substituting an old gun procured from a tenant, and hiding the good one, saved it to be afterwards carried by her husband in the Revolution.

On the breaking out of the war, Anthony and his brothers John and David, and his brothers-in-law, the Bumpasses, entered the Revolutionary Army, and served throughout the war. The roster of revolutionary soldiers, published by the state of North Carolina, shows that David was a sergeant.

James Bumpass Cozart was about sixteen years old when the war closed and six or eight years old at the time of the moulding of the bullets, and could remember the above described circumstances.

Life Stories of Gallant Americans

John Moor—The Knight of Derryfield

FROM FUGITIVE PAPER

BY HONORABLE ALBERT MOORE SPEAR

JUSTICE OF SUPREME JUDICIAL COURT OF MAINE

GREAT-GREAT-GRANDSON OF MAJOR JOHN MOOR

CONTRIBUTED BY MRS. LINA MOORE MCKENNEY, MADISON, MAINE

He lay upon his dying bed,
His eye was growing dim;
When with a feeble voice he called
His weeping son to him.
"Weep not, my boy," the veteran said,
"I bow to Heaven's high will;
But quickly from yon antlers bring
The sword of Bunker Hill."

The sword was brought; the soldier's eye
Lit with a sudden flame,
And as he grasped the ancient blade,
He murmured Warren's name.
Then said, "My boy, I leave you gold,
But what is richer still,
I leave you, mark me, mark me now,
The sword of Bunker Hill."

"Oh, keep that sword" — his accents
broke—

A smile and he was dead;
But his withered hand still grasped the
blade

Upon that dying bed.
The son remains, the sword remains,
Its glory growing still,
And twenty millions bless that sire
And the sword of Bunker Hill.

—SELECTED

LIVING as we do, surrounded by a mighty civilization, occupying mountain, valley, hill and plain from sea to sea; traversing space with the speed of the winds; spanning the oceans with the palaces of the deep; sending messages with lightning; living amidst these glories of the twentieth century and the splendor of its opening days—little do we comprehend the sorrows and the woes of the dark days when homes were the clearings in the forest; sustenance the caprice of the season; music the bay of the roaming beasts; safety the mercy of the Indian's knife; hope the return of their patriot brave.

It is of one who knew these hardships that I here relate—Major John

Moor, whose bravery in the American Revolution won him promotion, and who as a captain in many battles in the French and Indian War blazed the path for civilization. The Moor family, of which Major John was a member, migrated from Scotland to Londonderry, in the north of Ireland, about the year 1616. From there they came to this country in 1718, and settled in New Hampshire. The "Town Papers of New Hampshire," volume 12, page 429, show that on June 21, 1722, John Moor and one hundred and seventeen others were granted a township which they had incorporated by the name of Londonderry, in honor of the county in Ireland from which they had emigrated. In religious belief they were Scotch Presbyterians. The name was originally spelled Moor, the letter e being

John Moor—The Knight of Derryfield

omitted, but later generations adopted the present spelling.

The first record of the name is of one Samuel Moor, who married Deborah Butterfield and settled in Litchfield, then called Naticott, New Hampshire. They had six children, the second of whom was John. He was born November 28, 1731. He married Margaret (Peggy) Goffe, and settled in Manchester, New Hampshire, then called Derryfield. The family of Deborah Butterfield, the mother of our John Moor, came from a distinguished Norman family that arrived in England in the twelfth century, the head of the family being Robert de Buterville.

During the French and Indian War, when Colonel Johnson led 6,000 men against the French, New Hampshire furnished 500, one company being under Captain John Moor of Derryfield. On the twenty-sixth of August they arrived at Fort Edward, where Colonel Blanchard, with a regiment from New Hampshire, was left in charge of the fort. After this came the Battle of Lake George, in which the New England sharpshooters did valiant service. In the French and Indian War he won a reputation for courage and energy. After the conquest of Canada, he quietly settled down upon his farm at Cohas Brook.

When the alarm came in 1775, Captain John Moor of Derryfield led a company of forty-five men to Lexington. Upon arriving there he found that the British had retired into Boston. He marched to Cambridge, and on April twenty-fourth was commissioned by the Massachusetts Committee of Safety a captain in Stark's regiment.

John Moor's bravery at Bunker Hill makes him a hero whose name should be illuminated on the rolls of American chivalry. It was he, who with a few New Hampshire farmers, faced the Welsh Fusileers, the flower of the British Army, and the famous regiment that had fought with dis-

inction at Minden, gaining the title of the "Prince of Wales Regiment."

It was on the morning of June 17, 1775. The American Revolutionists were inviting the king's soldiers to a test of arms, and, with the spectacular manœuvering of the Old World military pageants, the British warriors, veterans of many gallantly won battle-days, moved toward the audacious Yankee farmers with the precision and coolness of a dress parade, and with the confidence and fearlessness born of conflict with greater and more learned enemies, the grenadiers and light infantry marching in single file, twelve feet apart, the artillery advancing and thundering as it advanced, while five battalions, moving more slowly, approached the fence, breastwork, and redoubt, forming an oblique line. The best troops of England assailed the New Hampshire line, doubtless expecting those half-armed provincials in home-spun clothes would fly before the nodding plumes and burnished arms of the light infantry and before the flashing bayonets and tall caps of the grenadiers.

Behind the fence, upon which they had placed grass to conceal themselves, lay, still as death, Captain John Moor and his men from Amoskeag, New Hampshire.

Now and then came a challenging shot from the brilliant British pageant, singing over their heads and cutting the boughs of the apple trees behind them.

Colonel Stark had planted a stake about eighty yards from the wall and fence, and had given orders to his men not to fire until the advancing line of the enemy should reach the stake.

On came the Welsh Fusileers, haughty and defiant. Still there came no response from the Yankee farmers.

Bang! Bang! Bang! The dead line had been crossed! Like a storm of thunder and lightning and lead there burst across their vision a mass of death-dealing flame, so intense, so

Life Stories of Gallant Americans

continuous, so staggering, that the flower of England wavered, recoiled, and fell back repulsed.

Again and again they rallied to the attack, only to again and again fall back blinded, wounded and depleted. One by one the brave grenadiers and light infantry fell before the Amoskeag farmers. One by one the gallant officers staggered to the earth, until broken in heart the living broke ranks and fled in dismay before the musketry of the hunters from the New Hampshire forests.

And when the smoke had cleared, ninety-six lifeless red-coats lay before the feet of Captain John Moor and his daring patriots, and nearly every officer and aid of General Howe lay wounded or dead. It is not too much to assume that if the rest of the American lines had been defended with equal success the entire British force would have been driven from the hill or annihilated.

When the dead were counted, after the battle-day at Bunker Hill, Major McCleary was among the lifeless, and Captain John Moor was called to the rank of major. He remained with the army for a few months, when the state of his wife's health obliged him to return to his farm. In the spring of 1777 Major Moor again enlisted among those of Derryfield, and retired from the army in 1778, when he removed to Norridgewock, at which place and North Anson he passed the remainder of his life.

Goffe Moor, son of John Moor, was also at the Battle of Bunker Hill, and was a drummer boy in his father's company. He was also a member of Captain Thomas McLaughlin's

company in Stark's regiment, in October, 1775.

An examination of the New Hampshire records discloses that Major Moor was a man who stood well among his neighbors as a civilian. I find that he filled nearly all of the municipal and parish offices in the gift of his people before he left New Hampshire. As to his career after he came to Maine, I quote from "Allen's History of Norridgewock": "In 1780, Major John Moor, who had been an officer in the army, came to this place in his uniform with epaulettes and insignia of rank, and excited considerable attention by his dress and address. He had four sons, who came with him. Having lost his wife, he married Mrs. Eunice Weston (Eunice Farnsworth), the widow of Joseph Weston, the first settler in Canaan. He was a man of more than ordinary talents, was respected for his intelligence and activity, and was a useful citizen. A financial report of the town affairs, in 1791, was drawn up by him in a correct and business-like manner, and remains (1849) in the files of the town papers. When the militia in the vicinity was reorganized, he was chosen colonel, and was esteemed as an officer and gentleman. He was granted a large lot, on which North Anson Village is now situated, and died there in 1809."

Major Moor had no children from his second marriage. The tenderness of Major Moor, the most commendable quality of his character, as it is of any man's, is a prominent feature of the traditions concerning him. True bravery is almost always the twin brother of tenderness.

O thus be it ever, when freemen shall stand
Between their loved home and wild war's desolation;
Blest with victory and peace, may the heaven-rescued land,
Praise the Power that hath made and preserved us a nation.
Then conquer we must, when our cause it is just,
And this be our motto—"In God is our Trust!"

James Caldwell—Hero of Elizabethtown

TRANSCRIPT FROM FUGITIVE PAPER CONTRIBUTED BY

MRS. HIRAM PRICE DILLON OF TOPEKA, KANSAS

Stay one moment; you've heard
Of Caldwell, the parson, who once preached
the word
Down at Springfield? What! No? Come—
that's bad; why, he had
All the Jerseys aflame! and they give him
the name
Of the "*rebel high priest*." He stuck in
their gorge,
For he loved the Lord God—and he hated
King George!

He had cause, he might say! When the
Hessians that day
Marched up with Knyphausen, they stopped
on their way
At the "Farms," where his wife, with a
child in her arms,
Sat alone in the house. How it happened
none knew
But God—and that one of the hireling
crew
Who fired the shot! Enough!—there she
lay,
And Caldwell, the chaplain, her husband,
away!

Did he preach—did he pray? Think of
him as you stand
By the old church today, think of him and
his band

Of militant plow boys! See the smoke and
the heat
Of that reckless advance,—of that strag-
gling retreat!
Keep the ghost of that wife, foully slain,
in your view,
And what *could* you, what *should* you,
what *would* you do?

Why, just what he did! They were left in
lurch
For the want of more wadding. He ran to
the church,
Broke the door, stripped the pews, and
dashed out in the road,
With his arms full of hymn books, and
threw down his load
At their feet! Then, above all the shout-
ing and shots,
Rang his voice, "Put *Watts* into 'em,
boys; give 'em *Watts*!"
And they did. That is all. Grasses spring,
flowers blow,
Pretty much as they did ninety-three years
ago.
You may dig anywhere and you'll turn up
a ball,—
But not always a hero like this—and that's
all.

—BRET HARTE

IT was in New Jersey. The distant rumble of approaching war had aroused the people to intense excitement. In the little community of Elizabethtown was one James Caldwell, a preacher, whose devotion to his faithful flock was their strongest support in this time of peril. The good parson was of that sturdy Scotch ancestry that knows no cowardice—the blood that flows in the veins of the Virginians and that infused fortitude into American character.

His father, John Caldwell, came to America and settled in the southern part of Virginia, in what is now Charlotte county, where James, the youngest of his seven children, was born in April, 1734. The place was called "Caldwell Settlement." A daughter of one of his brothers, also born there, was mother of the Honorable John Caldwell Calhoun, of

South Carolina, the noted senator and statesman of the South.

James Caldwell prepared for college under the instruction of the Reverend Todd. After hearing the Reverend Whitefield preach several times, he received a life-long impulse for good. James graduated from college in 1759, and received a call from the church of Elizabethtown, New Jersey, 1761. In 1763 he married Hannah, daughter of John Ogden, of Newark, New Jersey.

The causes of the American Revolution now aroused the people of New Jersey. No other parish in the land took a bolder, nobler stand, and few were more efficient in their country's cause than Reverend Caldwell. Among his congregation were Governor Livingston, Elias Boudinot, afterwards president of the Continental Congress; Abraham Clark, one of the signers of the Declaration of Independence; Honorable Robert Og-

Life Stories of Gallant Americans

den, speaker of the Assembly; and from this congregation went forth about forty commissioned officers to fight the battles of independence.

The journals of Congress show that in March, 1777, "\$200 were ordered to be paid to the Reverend James Caldwell, of Elizabethtown, for extraordinary services."

Reverend Caldwell was chaplain to the Jersey brigade and assistant commissary general from 1777 to 1779.

The old parsonage was destroyed by the torch of the enemy that year. The campaign of 1780 opened late, after the severe winter. Confident of success, General Knyphausen, with his Hessian troops, now in command of a part of the British army, began an invasion of East Jersey. An eyewitness of the passage of the troops says: "The Queen's Rangers, with drawn swords and glittering helmets, mounted on fine horses and followed by infantry composed of Hessian and English troops, about 6,000, all clad in new uniforms, gorgeous with burnished brass and polished steel, entered Elizabethtown. Instantly drums beat to arms at Morristown, and Washington and his troops marched with all speed to the post of danger."

The Reverend Caldwell had a few weeks before this removed his family from Elizabethtown to Connecticut Farms for safety, and had taken possession of the vacant parsonage.

When the British troops passed through the Farms, Mrs. Caldwell, with her maid, retired to a secluded apartment with the children. The girl looked out of the window and said: "A red-coat soldier has jumped over the fence and is coming towards the house with a gun."

The youngest child but one, Elias Boudinot Caldwell, two years old, playing on the floor, called out: "Let me see!" and ran to the window. Mrs. Caldwell arose from her chair, and at this moment the soldier fired his musket through the window at her. It was loaded with two balls,

which passed through her body, and she instantly expired.

A correspondent of the *New Jersey Gazette* says: "I saw her corpse, and was informed by the neighbors it was with infinite pains that they obtained leave to bring the body from the house before they set fire to it."

It is related of Reverend Caldwell that in the battle that followed he showed the utmost ardor in the fight, as if he would revenge himself for the murder of his beloved wife. He galloped to the church near by and brought back an armful of Psalm books to supply the men with wadding for their fire-locks, and shouted: "Now put Watts into them, boys; put Watts into them." The work of plunder began; nineteen houses and the Presbyterian church were destroyed.

In October, Lord Cornwallis surrendered his army and munitions of war to General Washington. Though the war was over, a class of adventurers and desperadoes were let loose on society, and several noted citizens became their victims, and among them the Reverend James Caldwell.

The *New Jersey Gazette* of November 28, 1781, says: "Last Saturday Reverend James Caldwell, minister of the Dissenting Congregation at Elizabethtown, was shot dead, without any provocation, by a native of Ireland named Morgan. The coroner's inquest brought a verdict of 'willful murder.' It was thought the ruffian was bribed by the enemy to do the dreadful deed. The British authorities had offered a reward for the assassination of Governor Livingston, and next to him Chaplain Caldwell was most dreaded by the enemy. The funeral services were performed on Tuesday, the twenty-seventh, the whole town suspending business and gathering in uncontrollable grief at the obsequies. An opportunity to view the body of Mr. Caldwell was given in front of the house on the open street. After all had taken the last look, and before the coffin was

James Caldwell—Hero of Elizabethtown

closed, Judge Boudinot came forward, leading nine orphan children of the deceased, and, placing them around the bier of their parent, he made an address of surpassing pathos to the multitude in their behalf. The procession slowly moved to the grave, weeping as they went. He was laid by the side of his wife's remains, and over his body was placed a marble slab with the following inscription: 'Sacred to the memory of Reverend James Caldwell and Hannah Ogden, his wife, who fell victims to their country's cause in the years 1780 and 1781.'

Honorable Elias Boudinot took upon himself the administration of the small estate and the care of the children left by Reverend Caldwell. The patrimony was eventually rendered productive, and the children were well educated.

They were greatly befriended by General Washington, Marquis de La Fayette, General Lincoln, and by Mrs. Noel who adopted the baby. Marquis de La Fayette obtained the privilege of adopting and educating the eldest son. On his departure, young Caldwell accompanied him to France and became a member of his family. He remained abroad until 1791, when, owing to the horrors of the French Revolution, he returned to America. He married Mrs. Van Wyck, and renounced papacy, which he had embraced in France, and became a member of the Cedar Street Presbyterian Church, New York, devoting himself to works of benevolence. He died in 1819.

Elias Boudinot Caldwell, the youngest son of James Caldwell, was adopted by the distinguished citizen for whom he was named. He was graduated at Princeton College, New Jersey; then studied law with Judge Boudinot and inherited his fine law library. He was appointed clerk of the Supreme Court of the United States, at Washington, at the age of twenty-four, in the year 1800, and continued to hold the office until his

death, in 1825. In the war of 1814 Lawyer Caldwell commanded a troop of cavalry in Maryland until the Battle of Bladensburg. The British then marched into Washington and set fire to the Capitol. Mr. Caldwell had only time to remove the archives of the United States Supreme Court, leaving his law library and other valuable property at the mercy of the enemy. It was all destroyed at the burning of the Capitol, August 24, 1814. This valuable library was in the north wing of the Capitol. It was placed there by Mr. Caldwell for the use of the judges of the Supreme Court. The British also greatly damaged Lawyer Caldwell's residence, which still stands on Pennsylvania avenue, 204 and 206, southeast, Capitol Hill, at which place the United States Supreme Court held its sessions for a short time after the Capitol was burned.

The Caldwell home was the seat of hospitality, and the honored and distinguished statesmen of that day were guests at his table. On one occasion he gave a dinner party, and among the guests were Mr. Webster, Mr. Clay, and Mr. Calhoun. In the course of conversation the subject of wealth, brains, and good blood was introduced. Mr. Webster said: "If I had my choice, I would take wealth." Mr. Clay said: "I would prefer noble blood." Mr. Calhoun and Mr. Caldwell desired to be good, useful men, and to live such lives as to be respected and loved by the community. Perhaps it was because each had good blood, brains and enough wealth for those days.

When the Marquis de La Fayette visited this country, in 1824, Mr. Caldwell went with his youngest daughter in his carriage as far as Bladensburg to meet him. He brought him to his house, where he remained some days. There was a strong friendship between the families.

Though Mr. Caldwell was a religious man, he was very liberal in his ideas. His children when old enough wished to go to dancing

Life Stories of Gallant Americans

school. He consented, and some of the other elders of the church waited on him to know if such were the case. "Yes," said he, "my children have dancing in their feet, and I prefer that it should come out gracefully."

Elias Caldwell was one of the founders of the American Colonization Society, of which he was corresponding secretary until his death. One of the towns of Liberia bears his name, and his last public prayer and the last note he wrote were for the enlightenment of the "Dark Continent." He was a member of the First Presbyterian Church, then located on Capitol Hill. He had been licensed to preach by the Presbytery, and was accustomed to occupy vacant pulpits on the Sabbath. He was noted for his generosity and benevolence. His name was connected with every good object of the day, and his life was crowned with blessings. He sometimes said: "I fear the Lord does not love me, as I have been prosperous in everything I have undertaken and happy in all the relations of life."

Mr. Caldwell made a request that his funeral should be plain, as an example to the poor, and that his remains should be placed in a pine cof-

fin, much to the disapproval of the undertakers, who, however, draped the coffin with black cloth.

Mr. Caldwell was married twice. The first wife was Miss Boyd, of Georgetown; the second was Miss Lingan, of Baltimore. He left eight children, all of whom inherited the traits of their remarkable ancestors.

The room of the clerk of the Supreme Court at the Capitol has now historic interest. The portraits of men who have filled that important office are hanging upon the walls, and among them that of Elias Boudinot Caldwell, the patriot, the scholar, and the refined Christian gentleman.

The portrait was taken from a miniature when Mr. Caldwell was twenty-four years old. The finely cut features, the clear blue eyes, and the fresh complexion are reproduced. The hair is powdered, as was the fashion in those days.

Mr. Caldwell was dignified in personal appearance, polished in manners, zealous in his public performances, and prompt to meet every demand that was made upon his ample fortune. He exerted a gentle influence not only over his own family and friends, but also over many of the leading minds of his day.

(AN OLD TAVERN SONG)

Our life is nothing but a winter's day,
Some only break their fast and so away;
Others stay dinner and depart full fed;
The deepest age but sups and goes to bed.
He's most in debt who lingers out the day,
Who dies betimes, has less and less to pay.

ESTATE OF A "WELL-TO-DO" AMERICAN IN 1689

"THIS IS AN INVENTORY OF THE WHOLE ESTATE
OF JOSEPH TAINTER, SENIOR, OF WATERTOWN,
WHO DYED THE 20TH OF FEBRUARY, ANNO
DOM 1689. TAKEN THIS 11TH OF MARCH"

TRANSCRIBED FROM ORIGINAL BY

M. AUGUSTA HOLMAN OF LEOMINSTER, MASSACHUSETTS

	£	S	D
In cash.....	34	01	00
Wearing Apparrell of all sorts.....	05	01	00

IN THE LODGING ROOME.

A feather bed with all belonging to it, with bedstead, curtains & valance, as it stands.....	07	00	00
A trundle bed-stid with a feather bed & what belongs to it as it stands....	03	00	00
A Fine pair of sheets; seven pillow coates.....	01	00	00
Three table cloathes, Eighteen napkins, six towels.....	02	08	00
One Chest, two boxes, two chairs, two cushions.....	00	12	00
A warming pann, A glass case with a parcel of glas bottles.....	00	07	00
A wodden mortar, A parcel of trenchers.....	00	05	00
A parcel of Books.....	01	10	00
A piece of Black cloth.....	00	10	00

IN THE FIRE ROOME.

Twenty pewter platters, six pewter porringers, one pewter flagon, one pewter drinking pot, four pewter drinking cups, two cups of tin, two basins of pewter, three pewter platters, one candle stick, one salt-seller, one little bottle, all of pewter, & a pewter chamber pot, four saucers... 03	00	00	00
Two brasse kettles, two brasse poles, two skilletts of brasse, a little brasse morten & pestle, brass candlestick, a brasse skimer & baleing ladle.... 02	10	00	00
Two iron pots, one Iron kittle, an iron morten & pestle, an iron candle- stick, an Iron skillet, two paire of pott hooks, a spit, a paire of cob irons, two tramels fire pan & tongs, a grid iron..... 02	05	00	00
Two small tables, power chairs, a smoothing box, eleven vessels of chiny ware, a dozen of trenchers, A fowling piece, two muskets, a case of pistols with holsters, power swords, with scabbardes and belts, two pair of bandolers* with ammunitions..... 05	04	00	00

* Ancient cartridge boxes being a belt of raw-hide filled with wooden bottles, each containing a charge of powder.

IN THE CHAMBER.

	£	S	D
A feather bed with the bedstead and apertinances to it, as it stands.....	03	10	00
A flock bed with the bedstead and the apertinances to it, as it stands.....	02	00	00
Several remnants of new cloath.....	01	05	00
Two moos skins ready dressed, and a parcel of small skins.....	03	00	00
One chest, two trunks & a parcel of button In one of the trunk.....	02	10	00
Furniture for a horse, as bridles, saddles, pannels, and a wodden basin, and a small lot of waiters, A parcel of ground malt..... 01	10	00	00
and rie.....	01	15	00



In Memory of General Robert E. Lee, on this Centenary (1807-1907) of his Birth
This, His Last Portrait, is Published, Knowing the Fondness with which he
Treasured it—Taken on his Old War Horse “Traveller” in the Garden
of his Home on the Campus of Washington and Lee University at
Lexington, Virginia, after his Return from the Great Struggle,
and during his Presidency of that Historic Institution—
He was born at Stratford, Virginia, January 19, 1807—
He Died at Lexington, October 12, 1870—On
This, His Centenary, the American People
Offer Tribute to his Memory as a Master
Military Tactician—Great in War—
Great in Peace—Beloved by
Friend and Foe

CENTENARY OF ROBERT E. LEE—A TRIBUTE BY THEODORE ROOSEVELT

Robert E. Lee will undoubtedly rank as, without any exception, the very greatest of all the great captains that the English-speaking peoples have brought forth—and this, although the last and chief of his antagonists may himself claim to stand as the full equal of Marlborough and Wellington

By Permission of the President on this Centenary of the Distinguished American's Birth from his “Life of Thomas H. Benton”

Adventures of an American Seaman

Journal of

Captain Samuel Hoyt *

Born in 1744 and followed the Roving

Life of his Generation * Life on a Fighting

Ship off Havana, Cuba, in 1762 * Experiences as a

Prisoner on a Privateer * Wanderings as a Fugitive along American Coast

TRANSCRIBED

BY

JULIUS WALTER PEASE

NOW IN HIS NINETY-THIRD YEAR AND A GRANDSON OF CAPTAIN SAMUEL HOYT

THE adventurous life of the early American in the age when the land was an unknown wilderness and the high seas were the more familiar highways is vividly pictured by the old journal left by one Captain Samuel Hoyt, an ambitious American youth who led the roving life of his generation and fought in the early wars of his country.

The journal of this rugged pioneer seaman is here recorded. The stalwart character behind the strong hand that inscribed it may be suggested by the knowledge that Samuel Hoyt was the son of one of the New World's first families. The Hoyts, who spelled their names variously, such as: Hoyte, Hoite, Hoit, Hait and Haight, had their beginning in America through Simon Hoyte, who was born in 1595, probably at Curry Rivel, Somersetshire, England, and came to this country in 1628 in the ship "Abigail" with Governor John Endicott, landing at Salem, Massachusetts, and exploring and settling Charlestown. In 1630 he became one of the settlers of Dorchester and in 1631 was made one of the first freemen in Massachusetts. From Dorchester he went to Scituate in 1633 and then became one of the settlers of Windsor, Connecticut, about 1639; thence to Fairfield about 1649, and then to Stamford, where he died in 1657, after having been either

an early, or one of the first settlers in seven New England towns.

Samuel Hoyt, whose journal is here recorded, is a product of this family in a later generation. His parents had migrated into the old seaport town of Guilford, Connecticut, where he was born at East Guilford (now in Madison) April 3, 1744. From his own notes one is informed of his experiences. He was twice married, the first occasion being to Clotilda Wilcox who was born April 29, 1745, and second to Mary Stone, a widow, who was born November 3, 1756. After eighty-two years of pioneer life Captain Samuel Hoyt died on October 5, 1826, at Madison.

The manuscript left by Captain Samuel Hoyt illuminates the indomitable courage of the pioneer Americans, their hardships and their sufferings. It gives one a better understanding of what it meant to have lived in the earlier years of the New World. The contributor recalls hearing his mother, who was the daughter of the narrator, tell of her father's experiences much the same as here recorded, and also of hearing her tell of scenes in the American Revolution. In transcribing the old journal it is edited only as necessary to preserve an illuminating story of the period. It is evident that Captain Hoyt rewrote his story from notes and memory in his mature years, probably shortly before his death.

Adventures of an American Seaman

On a Fighting Ship in Havana, Cuba, in 1762

THE first pages of the ancient journal seem to have been lost and the story abruptly begins with a record of experiences in Havana, Cuba, about 1762, when he was eighteen years of age, and an attack on Morro Castle and states that after the reduction of Morro Castle they proceeded up the harbor.

That the Hobson strategy of sinking a ship in the channel to bottle up the enemy in the recent Spanish-American War was practiced some one hundred and thirty years previously is shown by one of the first entries in this quaint journal. It says:

"We had not gone far before our progress was impeded by a large chain thrown across the channel and fastened at each end so firmly that it was impossible to force our way through. We were, however, successful in raising it upon the fore-castle of one of the smallest vessels when the carpenters, with their chisels, succeeded in cutting it in two. A short time after we were again brought up by a seventy-four gunship, which the inhabitants had sunk to prevent the approach of the enemy. We, however, soon removed this impediment. Before we arrived so near the town as to aid the land forces we were a second time obliged to stop on account of a ninety . . . ship placed in a similar manner to the other. As soon as the commandant of Cuba saw that the fleet had succeeded in clearing the channel of the obstacles that were thrown in the way he immediately capitulated and thus a further effusion of blood was prevented."

"It was not without horror," says the journal, "that I beheld a large number of bodies that were alive this morning in the enjoyment of health, now floating upon the surface of the water, having been thrown overboard from the ships."

Subsequent to the taking of Cuba Captain Crane received compensation for his services and sailed on the "Friendship," a vessel bound for New York. The lad, Samuel Hoyt, was his cabin-boy. A short time after they left Cuba they sighted an American vessel, which had been captured by the French and afterwards retaken by her own crew. Their situation was hazardous and they requested Captain Crane to take them and part of their cargo on board the "Friendship." He complied with their request and while performing this benevolent act of humanity lost sight of his company and for two or three days proceeded on his voyage without interruption. "At length a sail came into sight," says the journal. "For some time he kept on his way without seeming to regard them, but as the signals were often repeated he was induced at length, by motives of humanity, to bear down for her. He soon after discovered her to be a small sloop, and from her appearance concluded her to be the same one from which he parted three days before, but as he advanced nearer he felt less positive about it, and, recollecting that his orders were (it being time of war) to speak no vessel and let none speak with him, attempted to haul his wind and get at a greater distance."

A Cabin-Boy's Experiences as Prisoner on a Privateer

The journal says that it was then a little past sunset and unfortunately an almost perfect calm succeeded. They had not remained long in this anxious condition before they heard the sound of oars coming from a distance and soon after were summoned to strike to a French privateer. Captain Crane felt no great disposition to surrender his hard-earned property and delayed a compliance in hopes of being overtaken with a favorable gale; but as he was unprovided with the means of resistance, and delaying was dangerous, he surrendered his ship as a . . . prize and his men as prison-

Journal of Captain Samuel Hoyt—Born in 1744

ers. When the officers had taken formal possession of this brig they took the captain and several of his men on board their own vessel and left a prize master with a number of others to plunder at their leisure. Immediately upon their arriving on board the privateer a fresh breeze sprung up and the remainder of the prisoners (after having been stripped of nearly all their clothing) were forced to continue on deck the remainder of the night. In the morning they were removed on board the privateer and confined in her hold. When they entered their new habitation they found the vessel's company which sailed with them from Cuba. She was captured immediately after parting with the "Friendship" and sent off in another direction that the privateer might better succeed in decoying her companion. Here they were kept on a short allowance of provision and were allowed no water but what they sucked through a gun-barrel three feet in length, and even this privilege was not granted them but one minute in twenty-four hours. Yet notwithstanding the great severity of the captors Captain Crane had the address to obtain from them the chest which contained the . . . of his voyage. The captain of the privateer, upon examining his prisoners, observed many of them to be almost or quite naked, having been stripped of their coats, hats and breeches, upon which he made an immediate inquiry into the affair, and finding out the true cause of their present appearance, ordered his men, upon pain of his displeasure, to deliver up those things they had so barbarously forced from them.

After relating his experiences as a prisoner on a privateer, Samuel Hoyt in his journal says that his captors, having taken a number of prizes, proceeded to the Gulf of Florida, where she was met by an English battleship, which came for the purpose of exchanging prisoners. The captives were then ordered on deck and taken on board the "Beneato," a vessel of

twenty guns. Here their situation was somewhat more comfortable, but the rigorous discipline which they experienced in the ship soon made them sigh to regain their native liberty. Yet for the inestimable blessing all of them, except Captain Crane and his cabin boy, sighed in vain.

Samuel Hoyt tells this anecdote of his fidelity, as a cabin-boy, to his master: "Upon Captain Crane's leaving the ship, observing the first officer walking the quarter deck, I went to him, and pulling off my hat, requested leave to go on shore in company with Captain Crane. The officer immediately made this reply: 'We cannot spare you at present.' For the sake of consolation he, however, told me I might go on shore when the mainmast went. Not long after, having sprung the mainmast, they took it out and carried it on shore. When the boat was just shoving off, recollecting the promise given by the first lieutenant, I immediately stepped up to him with my hat under my arm and reminded him of his promise, when the mate, laughing heartily at the joke, told me I must wait until the foremast went on shore."

Life on the High Seas off the American Coast in Early Wars

The thrilling adventures of the cabin boy, who later became a captain, are now best told in his own words. The story in his journal, from this point, is narrated with the clearness and vigor of a born narrator as well as navigator. Here is the story as transcribed from the old manuscript:

"After parting from the privateer the 'Beneato' returned to South Carolina and continued to cruise off the coast several months. One day we discovered a large ship, and as we took her to be an envoy the vessel was immediately cleared for action and all agreeably were we surprised when we found it was a British packet which brought intelligence that a treaty of peace had been signed be-

Adventures of an American Seaman

tween the sovereigns of France and Great Britain. Upon this news all hands, dropping their arms, sprang upon the yards and saluted the packet with three cheers and being answered on board the packet we immediately hove about and stood for Charleston in company. The great joy at the news of peace was somewhat damped upon opening the mail from London wherein were orders for the immediate return of the 'Beneato.' This made the prisoners somewhat sorrowful. However, their manly courage never forsook them. A few days after, while lying at anchor, it being very early in the morning, a midshipman was ordered to go on shore for the purpose of filling the water casks. The midshipman, proceeding according to orders, we lashed the casks together, and, throwing them overboard, proceeded to man the boat when the officer, calling to the captain, requested more men. His answer was: 'Take what number you shall think necessary.' Upon the midshipman hearing this he called out to the men on board, saying: 'Come, my boys, jump into the boat.'

"I was on deck at this critical time and knowing that if I left this chance to slip unimproved I must, of course, go to England, the hopes of again seeing my friends and escaping from such cruel masters stimulated my drooping spirits and made me resolve to try my legs if I should be so fortunate as once more to feel *terra firma* under me. Having made this resolve and hearing the officer call out at the same time for more men I immediately sprang into the boat and sliding under one of the benches lay secreted until we all landed near the watering place. It being still duskish on account of the earliness of the hour I assisted in getting the casks out of the water and helped to secure the boat when the officer, calling to his men, says: 'Come, my boys, we will go and drink some bitters before we proceed any further in our work.' Fortune at last

seemed to favor me, and, lagging a little behind, I gladly saw them enter the house without observing my reluctance to follow them. The house was situated about forty or fifty rods from the boats. On the opposite side of the watering place was a lofty pine forest with thick underbrush at the entrance.

"A neighbor by the name of John Murray, who belonged on board the 'Friendship' at the time of her capture, happened at this time to be appointed boat-keeper. I made known my determination to Murray and requested him to accompany me. He at first thought my undertaking to be foolish in the extreme. I told him I had no time to lose and was resolved to try it myself should he still persist in his resolution of not accompanying me. I then began to walk toward the woods; when I had gone but a few rods, looking back I saw Murray following close at my heels. We continued to walk until we gained the woods, when, looking back, we saw the officer and men coming out of the house where they had gone for their bitters and walking very moderately down to the boat. This was the last time we saw this gentleman officer.

A Fugitive's Wanderings along the Desolate Atlantic Shore

"We had but just entered the woods when we began to try our skill in running. We directed our course into the thickest of the forest and ran until nearly out of breath when we beheld, to our great joy, a safe asylum from our pursuers. A large pine had, it seemed, been broken off near the ground; the tree being hollow we both crept into it where we remained through the day. When night approached we, creeping out of our den or hole like the wild beasts of forest, pursued our way unmolested; taking the stars for our guide we proceeded in an easterly direction until we found a road running to the northeast. We kept this road, walking as fast as possible through the whole night.

Journal of Captain Samuel Hoyt—Born in 1744

"Whenever we saw anybody traveling to meet, interrupt or overtake us we immediately sprang into the woods, so fearful were we of being apprehended. The next day we quit the road and traveled in the woods, taking the sun for our guide. The next night we proceeded in a quick pace, following the road through the night. The distance we had traveled gave us some hopes of escaping and we traveled through this day without leaving the road. We, however, kept a suspicious eye on all travelers we met; our fears of being taken somewhat subsiding, we found to our surprise we had appetites, not having eaten anything for the span of three days. We had no quarreling on the road, for money, the bane of society and source of all evil, was not in our possession, the officers being very cautious while on board not to corrupt our morals by leaving us the possibility of becoming spendthrifts. Our only resort now was to beg, which we tried, but without success, the inhabitants agreeing with the external appearance of the cottage, it being a wretched hovel, not fit for stabling cattle. Necessity knows no law; neither will hunger permit a man to slight the meanest hovel while there is a possibility of obtaining the least morsel of food to satiate an enraged stomach growling for its prey. We, however, made a shift to keep on our journey, but our steps were feeble and slow through the remainder of the day.

In an old Southern Mansion before America was a Nation

"Just at sunset we discovered a large and beautiful house standing upon a plantation. We quickened our pace and reaching the house a short time after sunset immediately knocked for admittance. When being told to walk in we obeyed and were shown into a room where a gentleman sat alone by the fire playing upon a violin for his own diversion. Immediately upon our entering the room the gen-

tleman ordered us to be seated. When we had told our story (one which we had framed before) he ordered one of the servants to boil us a small kettle of rice and in the meantime began to question us. At length, laughing at our fictitious stories, he gave us to understand he was fully persuaded we were runaways, but, to silence our fears, told us he would not expose us. Having eaten very heartily of the boiled rice he ordered for our lodging a couple bundles of straw which were laid on the floor before the fire. We slept well and arose in good season to proceed on our way.

"We traveled onward till near the middle of the afternoon when we came to a ferry where we were hindered for some time before we could get across, not having anything with which to reward the ferryman for his trouble. We, however, at length prevailed upon him to let his negro man set us across. After thanking him we proceeded on our journey. Sometime after sunset we were stopped by a narrow river which was very deep. We now perceived that we were on an island which was not inhabited. We cast our eyes around and, though it was night, we perceived a large magnificent house on the opposite side of the river. Upon this discovery we immediately hailed the ferryman as loud as we could holler, and being answered by a large negro it was not long before we were safe on the opposite side of the river.

"As soon as we were across we thanked the negro and telling him we were entirely unable to reward him as he deserved, were about to proceed on, when he gave us to understand we must go see massa. We obeyed accordingly and following the negro through a spacious hall we were at last introduced into an elegant room where sat a young man and three ladies. The eldest of the family appeared to be about sixty years of age and had become a widow but a short time since. There we were left standing for some time; at length,

Adventures of an American Seaman

after having surveyed us with apparent astonishment, he at last ordered us in a stern voice to be seated. After we had obeyed the young man and taken our seats we immediately began our lamentable story. He seemed to listen to it very attentively until we informed him that we were landed at Charlestown, when he interrupted us to inquire why we did not seek a passage by water as there were always plenty of northern vessels in Charlestown. We told him the small-pox was very prevalent there when we arrived at that port, and, as we had neither of us had it, we preferred going by land to Georgetown and taking a passage from there. 'You lie,' said he, 'you rascals! You have deserted from a man-of-war and in the morning I will take you back to Charlestown as I am authorized to return all deserters and receive five pounds sterling for every one I deliver.' We, however, (like old Job) held fast our integrity while he proceeded to examine and cross-examine us at his leisure.

"When he had pursued this method for some time to no purpose he became very humorsome and asked us a variety of questions about the amusements of the Yankees and the different productions of the New England states, etc., etc., but in the meantime he took care, now and then, to advert suddenly to the old subject in hopes, no doubt, of making us contradict our former assertions. We were, however, too much on our guard to be ensnared by this artifice; recollecting the old saying that 'a lie well stuck to is as good as the truth' we adhered to our story so firmly that he at last appeared to be convinced of our innocence. The aforementioned old lady, whom we took to be the mother of this young man, speaking to her son, said: 'I wonder you can be so much pleased in teasing those young men. I really believe they are honest lads and speak the truth.' Before this we observed she was setting an elegant table and concluded that the fam-

ily had not drank tea before we arrived. Then judge of our surprise and astonishment when the old lady informed us that this elegant entertainment had been prepared solely for us and gave us a cordial invitation to help ourselves to whatever we liked best. We had been some time without food and should probably have injured our health had not the idea of being carried back and delivered up as deserters taken away our appetites.

"As soon as we had supped the old lady commanded us to follow her; we obeyed and being led through numerous apartments we at length arrived in a small bed-room which was elegantly furnished, when the old lady, pointing to a bed in a corner of the room and setting down the light, says: 'My lads, you must sleep there,' telling us at the same time not to run away in the morning before she was up and bidding us 'Good evening,' left us to our repose. On the ensuing morning we arose early and the old lady, getting up soon after, loaded us with victuals, and, giving us some bitters, told us we now were at liberty to proceed on our journey. As soon as we had left the house we observed the negro, who had ferried us across the preceding evening, coming to meet us. Upon seeing him we told him his master had given us liberty to depart. 'Very well, massa,' was his reply. We then proceeded to state our poverty to him, making that as an excuse for our not rewarding him for his services to us the evening before. While racking my brains how to reward him I bethought myself of a pair of flannel drawers which I had constantly worn for near three months. These I determined at length to make him a present of. This I did the more willingly for two special reasons; the first was, the weather being so warm as to render them uncomfortable; the second reason being far the most weighty, as no doubt everyone will admit when they come to be informed that they contained living animals almost innumerable. The negro

Journal of Captain Samuel Hoyt—Born in 1744

seemed to be highly pleased with his present and I of getting rid of so large a quantity of live stock, so that all parties being suited, we parted on good terms—he to his daily labor and we to our occupation of traveling and begging.

In the old Seaport Town of Newport, 145 Years Ago

“We arrived at Georgetown just before the sun left the earth for the lesser lights to rule. We walked round amongst the shipping for some time without being able to find any vessel which belonged to New York. We, however, at last agreed with a certain captain, belonging to a brig, for our lodging on board of his vessel. We continued in this situation, working hard for the span of fifteen or sixteen days, and all the wages we received was our daily bread. We at length engaged a passage on board of two different vessels bound to Rhode Island. We, however, got separated soon after we left Georgetown by a gale of wind from the northeast, which continued to blow for the span of twenty-four hours with unabated fury. After the storm subsided we proceeded on our way without anything remarkable taking place. I shall only observe that after fourteen days’ passage we arrived safe in Rhode Island about thirty miles east from Newport, where I arrived just after sunset the same day.

“After arriving at Newport I spent the evening in wandering about the town and among the shipping in hopes on finding some one of my acquaintance who would be humane enough to find me a lodging, I being wholly destitute of money, not even having anything I could barter for a lodging. At length, my strength and fortitude leaving me, I seated myself upon a log and wept over my cruel fate. I remained in this melancholy train of reflection for some time till at length, arousing from this horrible train of ideas, I determined, if possible, to get liberty to sleep in some vessel’s hold,

that the deck might cover me from the dews, which were very large at this season of the year. I had not proceeded far down the wharf with this intention, when lo! to my astonished sight, I beheld Captain Thomson, an old acquaintance. He immediately invited me on board of his vessel which lay down at the end of the long wharf. When we arrived on board he gave orders for a supper to be got ready as soon as possible. After supper I was requested by all present to give them a relation of my adventures.

“According to their request I gave them a true account of the dangers and hardships I had gone through, which kept us up to a very late hour. We at length, however, retired to rest and arose the ensuing morning in high spirits, being refreshed by that all-powerful god, called by the ancients Morpheus, who befriends the miserable and revives the drooping spirits of the meanest slave. The vessel which I slept on board of, sailing the next morning, I found myself once more alone, without friends or acquaintance. I once more sat myself down without knowing what to do or which way to go. While I remained in this situation I once more cast a wistful look upon the harbor in hopes of seeing some vessel enter it with some acquaintance on board who might contribute to my relief, or, to state my still stronger hopes, I was trying my utmost to find a vessel in which I might embark for New Haven or even New York. After looking some time I at length beheld a vessel beating up the harbor (the wind being ahead).

“After looking some time at the vessel, I again falling into my old train of melancholy reflections, continued to ponder over my unhappy fate until I was broken off by having my name called in an audible voice, when, standing up, I looked around me with amazement, wondering who the person could possibly be, as I had no acquaintance in Newport. After looking for some time without being

Adventures of an American Seaman

able to learn from whence the voice proceeded I was again about to reseat myself and concluded it was nothing more than disturbed imagination when my ears were again saluted by hearing my name called a second time, more distinctly and much louder than I did the first time. I again looked around me, somewhat perplexed at my not being able to find the person who had repeated my name twice undiscovered. At length, however, I espied the person who had been hailing me standing upon the windlass of a vessel I have mentioned before that was beating up the harbor.

“Upon observing the person more narrowly I recognized my old friend and fellow-sufferer, Murray (who came from Georgetown in another vessel and had been separated from us by a storm soon after we left that place.) As soon as the vessel reached the wharf we were in each other’s arms and resolved not to separate again, let what would take place, until we should arrive safe at home. N. B. This makes the old proverb

good, ‘Misery loves company.’ I being happy in the acquisition of my old friend, Murray, we remained together through the day. It growing towards night, we thought it advisable to look about us for a lodging; walking down the wharf for this purpose, we saw a vessel just arrived, and going on board, inquired of the captain where she was bound, and being embarked on board and arrived safe in New Haven the next day before sunset. We immediately went on shore and proceeded as far as East Haven, when we took up our lodging with a distant relative of mine for that night.

“The next morning we arose early, and not having anything to impede our progress, proceeded on our journey with alacrity and arrived home at Guilford soon after the sun had passed the meridian, where, to the no small joy and surprise of our friends, we were received with exclamations of satisfaction and wonder almost exceeding belief. We on our part were highly delighted with the idea of having arrived safe home after having been absent twelve months.”

ONE OF THE FIRST INSTANCES OF BOYCOTT IN AMERICA

Major Peter Norton was born in Edgartown, Massachusetts, September 9, 1718. He was a prominent citizen holding the office of sheriff and attained the rank of major in the Continental Army. He was a leader in overt acts in resisting British policies and died February 3, 1792

TRANSCRIPT FROM ORIGINAL CONTRIBUTED BY

ELLA S. DUNCAN OF KEOKUK, IOWA

GREAT-GREAT-GREAT-GRANDDAUGHTER OF MAJOR NORTON

We the subscribers, inhabitants of the town of Edgartown, do sincerely and truly covenant and agree to and with each other, that from and after the first day of January A. D. 1775, that we will not directly nor indirectly by ourselves or any for or under us, purchase of any person or persons whatever for the use of our families any kind of goods, wares or merchandise of the growth, produce or manufacture of Great Britain or of the East Indies, imported from Great Britain, except tools for manufactures and husbandry, nails, pins and needles, until our Charter *Rites* be restored, and the Port of Boston be opened, and if any person or persons belonging to said town shall refuse to sign this or a similar agreement at or before the said first day of January, that we will deem them enemies to the country and supporters of the Oppressive Acts of the British Parliament. And whereas many of us, the subscribers, are owners of sheep, we also agree that we will sell our wool for one shilling per pound until our *Rites* are restored as aforesaid.

Witness our hands at Edgartown November the 8—1774.

PETER NORTON
WM. JERNIGAN.

Experiences in Early Wars in America

Life Story of
an Ambitious American
Youth who at Sixteen Years of Age
was Fired with the Spirit of Patriotism and
against the Will of his Parents marched to the Battle-line
in Defense of His Country & Original Journal of Peter Pond, Born in 1740

TRANSCRIBED

BY

MRS. NATHAN GILLETT POND

AN EMINENT AMERICAN GENEALOGIST AND WIFE OF THE LATE GREAT-GRANDNEPHEW OF PETER POND, THE
WRITER OF THIS ANCIENT JOURNAL

I HAVE in my possession old manuscripts, almost indecipherable which I believe to be of much import, throwing as they do, a strong, clear light on one of the most important periods in American history.

The ancient manuscripts were found by me in 1868, about to be destroyed with waste paper in the kitchen of the home of Hon. Charles Hobby Pond, governor of Connecticut. A member of the family was tearing off pages from an old time-stained document.

"What is that?" I inquired, "It looks interesting."

"Why, it's nothing but old 'Sir' Peter Pond's journeys," she replied, "It's not worth anything. You are welcome to it."

In my young days I cultivated the habit of devouring everything that looks interesting, and that characteristic seems to have served me well in this instance. In deciphering the musty sheets I was fascinated by the quaint diction and phonetic spelling. It indeed is a model for the modern reformers who would carry our English orthography back to its most primitive elements.

I find that "Sir" Peter Pond in his journal relates his experiences in this very romantic period to which Washington Irving gives this significance: "Two leading objects of commercial gain have given birth to wide and daring enterprise in the early history of the Americans; the precious metals of the South, and the rich peltries of the North. These two pursuits have been the pioneers and precursors of civilization. Without pausing on the borders, they have penetrated at once, in defiance of difficulties and dangers, to the heart of savage countries; laying open the hidden secrets of the wilderness; leading the way to remote regions of beauty and fertility that might have remained unexplored for ages, and beckoning after them the slow and pausing steps of agriculture and civilization. The Indians, as yet unacquainted with the artificial value given to some descriptions of furs, in civilized life, bartered them away for European trinkets and cheap commodities. Immense profits were thus made by the early traders, and the traffic was pursued with avidity."

The journal is of such length that at this writing I will record only the portion of it which relates to his boyhood in the early wars of America.

Experiences in Early Wars in America

I WAS born in Milford in the county of New Haven in Conn the 18 day of Jany 1740 and lived thare under the Government and protection of my parans til the year 56. A Part of the British troops which Ascaped at Bradixis Defeat on ye Bank of the Monagahaley in Rea the french fortayfycation which is now Cald fort Pitmen Cam to Milford. Toward spring Government bagan to Rase troops for the Insewing Campaign aganst Crown point under the Comand of General Winsloe. Beaing then sixteen years of age I Gave my Parans to understand that I had a Strong Desire to be a Solge. That I was detarmind to enlist under the Officers that was Going from Milford & joine the army. But thay forbid me, and no wonder as my father had a Larg and yung famerly I Just Began to be of sum youse to him in his affairs. Still the same Inklanation & Sperit that my Ansesters Profest run thero my Vanes. It is well Known that from fifth Generation downward we ware all waryers Ither by Sea or Land and in Dead so strong was the Popensatey for the arme that I could not with stand its Temlations. One Eavingen in April the Drams an Instraments of Musick ware all Employed to that Degrea that thay Charmed me. I repaired to a Publick house whare Marth and Gollatrey was Highly Going on. I found Miney lads of my Aquantans which Seamd Detarmined to Go in to the Sarvis. I talkt with Capt Baldwin and ask him weather he would take me in his Company as he was the Recruiting Offeser. He Readealey agreed and I set my hand to the orders. My Parans was so angry that thay forbid me making my apearance at Home. I taread about the town among my fello Solgers and thought that I had made a profitable Exchange giting a Rigmintal Coate in Plase llard Cloth. At Length the time Came to Report. Early in June we imbarked on bord a Vessel to join the Arme at the randivoere. We sald from Milford to New York proceeded up North river and arrived safe at Albany. I cam on Smartly as I had sum of my Bountey Money with me. I did not want for Ginger Bread and Small Bear and sun forgot that I had left my Parans who were Exseedingley trubeld in Minde for my wellfair. After taring thare sum Weakes the Prinsabel Part of the Armey got together and we Proseaded up to the Halfmoon and thare lay til the hole of the Armey from Differant Parts of the hole Countray Got to Gather. In the meantime Parties and Teamsters ware Imploid In forwarding Provishon from Post to Post and from Forte Eadward to the head of Lake George. It was supposed that we should Crose Lake George and make a Desent on ticondaroge But before that could be a Complished the sumer ended. Fall of Year Seat in and we went to work at the fort George which lay on the head of the Lake by that name. In November it Groed two cold to sleap in tents and the men began to Mutanie and say that thay had sarved thare times out for which thay ware inlisted and would return Home after Satisfying them with smooth words they ware Prevailed on to Prolong the Campain a few weakes and at the time promest by the Ginarel the Camp broke up and the troops returned to thare respective Plasis in all parts of ye Country from which thay came But not without leaving a Grate Number Behind which Did with the Disentary & other Diseases which Camps are subjet to Appesaley among Raw troops as the Amaracans ware at that time and thay Beaing Strangers to a holesome Mod of Cookeraray it mad Grate Havock with them in making youse of Salt Provishons as thay did which was in a grate part Broylng & Drinking water with it to Exses.

The year insewing which was 57 I taread at home with my Parans so that I ascaped the Misfortune of a number of my Countrey men for Moncalm came against fort George & Capterd it & as the amaracans ware Going of for fort Edward a Greabel to ye Capatalasion the Indians fel apon them and mad grate Havack.

In ye year 58 the Safety of British Amaraca required that a large Arme

Journal of Peter Pond—Born in 1740

should be raised to act with the British Troops against Cannaday and under the command of General Abercrombie against ticonderoge. I found taring at home was too Inactive a Life for me therefore I joined many of my old Companyans a secont time for the Arme of ye end of the Campain under the same Officers and same Regiment under the command of Cornl Nathan Whiting. In the Spring we embarked to gine the Arme at Albany whare we arrived safe at the time appointed. We ware emloid in forwarding Provishuns to Fort Edward for the youse of the Sarvis. When all was readey to cross Lake George the Armey Imbarked consisting of 18000 British & Provincals in about 1200 Boates and a number of whalebotes, floating Battery, Gondaloes, Rogal-leyes & Gunbotes. The next day we arrived at the North end of Lake George and landed without opposition. The french that were encampt at that end of the Lake fled at our appearance as far as Ticonderoge & joined thare old commander Moncalm & we ware drawn up in order and divided into Collams and ordered to March toward Montcalm in his camp before the fort—but unfortunately for us Moncalm like a General dispatched Five hundred to oppose us in our landing or at least to Imbarres us in our March so he might put his Camp in some sort of defense before our Arme could arrive & thay did it most completely. We had not Marcht more than a Mile & a Half Befoare we Meate the falon Hope for Such it Proved to be. The British troops Kept Rode in One Collam the Amara Cans Marcht threw ye Woods on thare Left. On ye Rite of the British was the Run of Water that Emteys from Lake George into Lake Champlain. The British & French Meate in the Open Rode Verey Near Each Other Befoar thay Discovered the french On a Count of the Uneaveneas of the Ground. Lord How held the secont Place in Command & Beaing at the Head of the British troops with a small sidearm in his hand he Ordered the troopes to forme thare front to ye Left to atack the french But While this Was Dueing the french fird & his Lordship Received a Ball & three Buck shot threw the Senter of his Brest & Expired without Spekeing a word. But the french Pade Dear for this Bold attempt. It Was But a Short time Befoare thay ware Surrounded By the Hole of the Amaran troops & those that Did not Leape into the Raped Stream in-Order to Regan thare Camp ware Made Prisners or Kild & those that Did Went Down with the Raped Curant & Was Drowned. From the Best Information I Could Geat from ye french of that Partea was that thare was But Seven men of ye five Hundred that Reacht the Camp But it answered the Purpas Amaseingly. This affair Hapend on thirsday. The troops Beaing all Strangers to the Ground & Runing threw the Woods after the Disparst frenchmen Night came on and thay Got themSelves so Disparst that thay Could not find the way Back to thare Boates at the Landing. That Nite the British did Beatter haveing the Open Rod to Direct them thay Got to ye Lake Sid Without trubel. A Large Party of ye amaracans Past the Nite within a Bout half a Mile of the french Lines With Out noeing whare thay ware til Morning. I was not in this Partey. I had wanderd in ye Woods in the Nite with A Bout twelve Men of my aquantans—finealey fel on the Rode a Bout a Mile North of ye spot whare the first fire began. Beaing in the Rode we Marched toward Our boates at ye Water Side But Beaing Dark we Made But a Stumbling Pece of Bisness of it & Sun Coming aMong the Dead Bodeyes Which ware Strewed Quit thick on the Ground for Sum Little Distans. We Stumbled over them for a while as long as thay Lasted. At Lengh we Got to the Water just Before Day Lite in the Morn. What Could be found of the troops Got in sum Order & Began our March a Bout two a Clock in ye Afternoon Crossing the Raped Stream & Left it on Our Left the rode on this Side was Good & we advansd toward the french Camp as fars the Miles About a Mile from the Works & thare Past the Night Lying on Our Armes. This Delay Gave the french What thay Wanted—time to secure thare Camp which was

Experiences in Early Wars in America

Well Executed. The Next Day which was Satterday about Eleven we ware Seat in Mosin the British Leading the Van it was about. They ware Drawn up Before Strong Brest Work but more in Extent then to Permit four thousand five Hundred acting. We had no Cannon up to the works. The Intent was to March over this work But they found themselves Sadly Mistaken. The french had Cut Down a Grate number of Pinetrease in front of thare Camp at som distance. While som ware Entrenching Others ware Employed Cuting of the Lims of the Trease and Sharpening them at Both Ends for a Shevoe Durease, others Cuting of Larg Logs and Geting them to the Brest Works. At Lengh they ware Ready for Our Resaption. About twelve the Parties Began thare fire & the British Put thare Plan on fut to March Over the Works But the Lims and tops of the Trease on the Side for the Diek Stuck fast in the Ground and all pointed at upper End that thay Could not Git threw them til thay ware at Last Obliged to Quit that plan for three forths ware Kild in the atempt But the Grater Part of the armye Lade in the Rear on thare fases til Nite while the British ware Batteling a Brest work Nine Logs thick in Som plases which was Dun without ye Help of Canan tho we had as fine an Artilerey Just at Hand as Could be in an armye of fifteen thousand Men But thay ware of no youse while thay ware Lying on thare fases. Just as the Sun was Seat ing Abercrombie came from left to Rite in the rear of the troops ingaged and Ordered a Retreat Beat and we left the Ground with about two thousand two hundred Loss as I was Informed By an Officer who saw the Returns of ye Nite Wounded and Mising. We ware Ordered to Regain our Boates at the Lake Side which was Dun after traveling all Nite so Sloley that we fell asleep by the Way. About Nine or tenn in the Morning we ware Ordered to Imbark & Cross the Lake to the Head of Lake George But to Sea the Confusion thare was the Solgers Could not find thare One Botes But Imbarked Permisherley whare Ever thay Could Git in Expecting the french at that Heales Eaverrey minnet. We arived at the Head of the Lake in a short time—took up our Old Incampment which was well fortified. After a few Days the armye Began to Com to themselves and found thay ware safe for the hole of the french in that Part of the Country was not more than three thousand men and we about forttee thousand. We then Began to Git up Provishan from fort Edward to the Camp But the french ware so Bold as to Beseat our Scouting Partey Between the the Camp and fort Edward & Cut of all the teames, Destroy the Provishun, Kill the Parties and all under thare ascort. We Past the Sumer in that Maner & in the fall Verrey late the Camp Broke up and what Remaned Went into Winter Qarters in Differant Parts of the Collanees thus Ended the Most Ridicklas Campane Eaver Hard of.

The year 59 an armye was Rased to go aganst Niagaray to Be Commanded by Ginerall Broduck. As the Connecticut troops ware not to Be Imploid in that Part of the armye I went to Long Island and Ingaged in that Sarvis. In the Spring we Repaired to Albany & Gined the armye as that was the plase of Rondevuse. We ware Imploid in Geating forward Provisions to Oswego for the Sarvis of the Campain. When we asemeled at Osawaga Col Haldaman took Part of the troops under his Command & Incampnt on the Ontarey Side But the troops that ware Destind to Go aganst Niagara Incampnt on the Opaset Side of the River under the Command of Genneral Braddock But the Company I Belonged to was not ordered Over the Lake at all But Col Johnson who was in the Garsea Sarvis sent for me In Partickler to Go Over the Lake. I wated on him and Inquired of him how he Came to take me the Ondley Man of the Company Out to Go Over the Lake. He sade he had a mind I should be with him. I then asked him for as manye of the Company as would make me a Seat of tent mates. He sun Complid & we went & Incampnt with the troop for that Sarvis. Capt Vanvater Commanded the Company we joind. We sun

Journal of Peter Pond—Born in 1740

Imbarkt and Arived at Nagarey. In a few Days when all ware Landead I was Sent By the Agatint Mr. Bull as Orderley Sarjant to Genaral Braduck. I was Kept so Close to my Dutey that I Got neither Sleape nor Rest for the army was up Befoare the Works at the fort and the General was Down at Johnsons Landing four Miles from the acting Part of the army. I was forced to Run Back & forth four miles Nite and Day til I Could not Sarve Eney Longer. I sent to Mr. Bull to Releave me by Sending another Sargint in my Plase which was Dun & I Gind my friends agane and fought In the trenches aganst the fort. Befoar we had Capterd the fort the Gennarel had gind the arme & himself & my frend Col Johnson ware Both Kilt in One Day and Col Shaday of the New York troops shot threw the Leag. This was a Loss to Our Small army—three Brave Offesars in One Day. We Continued the Seage with Spereat under the Command of Sir William Johnson who it fell to after the Death of Braduck. I was faverd—I Got but One Slite wound Dureing the Seage. At the End of Twenty five Days the fort Capatalated to leave the Works with the honners of war & lay down thare Armes on the Beach whare thay ware to Imbark in Boates for Schanectady under an escort. After apointing troops to Garsen the fort we Returnd to Oswago and Bilt a fort Cald fort Erey. At the Close of the Campain what was alive returned Home to thare Native places But we had left a number Behind who was in thare Life Brave Men. On my Arival at Milford I found Maney of the Prisners I had Bin so Industres in Captering ware Billeated in the town. I Past the winter among them.

In 1760 I Received a Commission and Entered a forth time in the army. We then Gind the Armye at the Old Plase of Rondavuse and after lying there a few weakes in Camp Duing Rigimental Dutey General Armarst Seat of in pourshen to Carre the Baggage to Oswago whare Part of the Armye had all ready arived. I was Ordered on this Command—four Offesers & Eighty Men. On our arrival at Oswago the Genarel gave the other three Offesers as Maney Men as would man One Boate & Ordered them to Return to thare Rigiment. Me he Ordered to Incamp with my Men in the Rear of his fammerley til farther Orders with Seventy Men til Just Befoar the armye Imbarkt for S—— and then Gind my Rigiment. Sun after thare was appointed a Light Infantry Company to be Pickt Out of Each Rigiment—Hats Cut Small that thay mite be youneform. I was appointed to this Company. When orders ware given the Armye about Nine thousand Imbark in a Number of Boates & went on the Lake toward Swagochea whar we Arived safe. Thare we found Pashoe that had Bin taken at Niagarey the sumer Before Commanding the fort and Semed to Be Detarmined to Dispute us & Give us all the trubel he Could But after Eight or a few more Days he was obliged to Comply with the tarmes of Our Victoras armye a second time in les than One year. We then Left a Garrson & Defended the River til we Reacht Montreal the Ondley Plase the french Had In Possession in Canaday. Hear we lay one Night on Our Armes. The next Day the town Suranderd to General Amharst.

In the years while I was in the Armye all Canaday was in the Hands of the British Nor have thay Had aney Part of it Sins. All Canaday subdued I thought thare was no bisnes left for me and turned my atenshan to the Seas thinking to make it my Profession and in Sixtey one I went a Voige to the Islands in the West Indees and Returnd Safe but found that my father Had gon on a trading Voig to Detroit and my Mother falling Sick with a feaver Dide Before his Return. I was Oblige to Give up the Idea of going to Sea at that time and take Charge of a Young fammaley til my father Returnd after which I Bent my Mind after Differant Objects and tared in Milford three years which was the Ondley three years of my Life I was three years in One Plase Sins I was Sixteen years old up to Sixtey.

BILL OF SALE OF A NORTHERN SLAVE IN 1721

Transcribed by ELIZA COMSTOCK, of New Canaan, Connecticut

GREAT-GREAT-GRANDDAUGHTER OF THE SLAVE HOLDER

MY great - great grandfather was a slave owner. Among his old papers, that have come down through the generations, I find a bill of sale of a twelve year old negro boy, named "Cesar," in 1721. I also find a will left by this same negro "Cesar" in 1773.

These documents give an insight into the trade which had become an established American custom in these early days of the colony. They are of stronger evidence than volumes of written theories or arguments.

It is significant that "Cesar," the slave, accumulated property, as is shown by his "last will and testa-

ment," and that while he was unable to sign his own name, his property consisted largely of books. I have transcribed it accurately from the copy of the will still in my possession. I find that this will was admitted to probate in Norwalk, Connecticut, and is on the records of that probate district.

These documents tell their own story. It is unnecessary for me to elucidate them other than to mention that "Dwer" and "Belinda," to whom "Cesar" made bequests in his will, were fellow-slaves. I remember hearing my father speak of them. The quaint documents are here recorded :

To all People to whom these presents shall Come, greeting—

Know ye that I John Davice of the Town of Bastable in the County of Bastable in ye Province of ye Machejuset Bay, for and in Consideration of the sum of fifty and eight pounds in Current Money of the Colony of Connecticut: to me in hand Payed by Moses Comstock of the town of Norwalk in the County of Fairfield in ye Colony of Connecticut; have given granted bargained sold and by these presents Delivered unto the aforesaid Moses Comstock a Cartain Negro boy (aged about twelve years) Caled and known by the Name of Cesar: for him to have and to hold said Negro boy to him the said Moses Comstock, his heirs, Executors, Administrators and assignes during the term of said Negros Natural Life; and in witness wheareof I heare hereunto sett my hand and seal this 26th day of April Anno 1721.

Signed sealed and delivered

In presence of

Berys A. Lines.

Jacob Hays.

John Davice. (Seal)

QUAINT WILL OF A NEGRO SLAVE IN 1773

J CESAR Negro Man of Abijah Comstock of Norwalk in the County of Fairfield and Colony of Connecticut, Being of sound Mind and Memory And Calling To Mind my Mortallity, Knowing it is Appointed for all Men once to Die With the approbation of my Above s'd Master Do make and ordain this my Last Will and Testament. As follows, Viz.—

1st I give to my master Abijah Comstock my Great Bible, Confession of Faith, Mathew henry upon the Sacrament one old Trap of my Deceased Masters and woppit. Furthermore—

and I give to my Master's son David my small Bible & psalm Book, Willison's Explanation, Joseph Allen, Thomas Gouge, My new chest And young Bobben trap and half of my Money Except a reserve Hereafter made even the price of a silver Spoon Left at the Discretion of my Master to purchase &c.

3rd I give to my Masters son Enoch, Joseph Sewall, Dr. Watts Catechism, Thomas Shepperd Solomon Stodard and S Wright My clasp paper pocket Book My New Bever hat and Case And hayt trap And the other half of my Money Except the Value of one silver spoon.

David and } At Masters Decease my Great Bible to David And the
Enoch. } rest to Enoch.

If Either of my Masters above sd. sons Dye without heirs The survivors to take what I gave to the Deceased.

My silver spoon to Hannah
A silver spoon to Dinah
A silver spoon to Deborah } My Master's Daughters

To Thomas My Masters Eldest son The Dissenting Gentlemans Anns.

To Abigail Eells
To Moses Eells } Ye Almost Christians and when Deced.

To Hannah hanford—Four Books—Viz. Law & Grace, John Bunyon, Vincens Sudden and Certain Appearance to Judgment—Vincens Explanation upon the Catechism. John Fox, Time & End of time.

To Phineas hanford one trap called old Bobben.

To Samuel hanford one Book a Cordial to the fainting Saint.

My silver shoe Buckles & knee buckles & clasps which was above forgotten With my Tankard Quart pot and Bason To David with my sleeve Buttons and Gloves.

My old chest to Dwer and then to Dwer and Belinda all my caps and handkerchiefs, old shoe buckles to Dwer and knee buckles.

February ye 13th A. D. 1773. I appoint my Master Abijah Comstock to be Executor of this my last will and testament.

Daniel Lockwood.

Samuel Lockwood.

His
Cesar x Seal
Mark

A MOTHER'S LETTER TO HER SON IN 1789

TRANSCRIPT OF LETTER WRITTEN BY MRS. MARY WRIGHT ALSOP, BORN FEBRUARY 24, 1740, TO JOSEPH WRIGHT ALSOP, BORN MARCH 2, 1772—NOW IN POSSESSION OF A DESCENDANT, JOSEPH ALSOP OF AVON, CONNECTICUT

Dear Joseph:—

My great concern for your Prosperity in this World and your Happiness hereafter, have induced me to give you my Advice in writing; hoping you will read it frequently, and impress it on your Mind, and regulate your conduct by it——In the first place, I wish you to have a due sense of your dependance on God; and that will induce you to be careful not to be offensive in thought, word or deed——Never Mention the word of God but with reverence——You must never jest with anything Sacred or Religious——Attend Church constantly, and behave with decency when there——Carefully avoid all profane Language, for it is very wicked, and no pleasure or advantage can arise from it——

Execute the business allotted to you with the utmost exactness and fidelity——Always study to give satisfaction to those with whom you live——Be not difficult to please with respect to your diet, or anything else; for it argues an insolent temper, and will gain the ill will of everyone that lives with you; and you will not only loose the esteem of the family but will fare worse in every respect——

Avoid gameing of every kind; it is a pernicious Vice; Many have been ruined by it: shun it in the smallest degree for it will lead you imperceptibly on to destruction. God grant my advice on this head may be unnecessary; as I hope you have no propensity to gameing——Shun the company of idle dissolute people; never on any account associate with such; if you do they will most certainly hurt your Morals, and your character will be ruined——

Be careful never to offend any one; but if you should inadvertently do it, readily make a proper acknowledgment; for candidly to confess our faults, argues a generous mind, and we are more esteemed for it——Be not too ready to take or resent an affront; it is much better to pass over trifles, than to be continually irritated; a person of that temper frequently take offense when there was none intended——But if an affront is really intended, resent it properly, but not with ill language, or too vulgar behaviour——

Be decent in your Dress but not fopish or extravagant; for you will not be esteemed by those whose opinion are of any consequence for your dress but for your good behaviour——

I flatter myself it is not needful for me to mention Honesty and integrity to you——

If there is anything more than I have not particularly mentioned, your own reflections will suggest them to your mind, and supply the deficiency——

I hope you will peruse this with that attention which I think my great concern for your present and future welfare demands——That God will Bless and Protect you, and give you Grace so to conduct yourself thro' Life, that you may, thro' the Merits of our Redeemer, be everlastingly happy, is the fervent prayer of your affectionate mother——

30th March 1789
Joseph W. Alsop.

Mary Alsop.

Pioneer Life on American Frontier

Experiences
of a Federal Justice
on the Trail of the Prairie Schooners &
Carrying the Law into the Western Wilderness &
Treaties with the Indians and the Establishment of Courts
in a Land of Gold and Silver & The Birth of the Rich West & Reminiscences

BY

JUDGE LYMAN E. MUNSON, LL.B.

JUSTICE OF THE UNITED STATES DISTRICT COURT OF MONTANA UNDER APPOINTMENT OF PRESIDENT LINCOLN IN 1865, AND WHOSE JUDICIAL DECISIONS WERE INSTRUMENTAL IN MOULDING THE TERRITORIAL DESTINY OF WESTERN AMERICA—BORN IN MASSACHUSETTS IN 1822, AND NOW RETIRED FROM ACTIVE PRACTICE IN HIS EIGHTY-SIXTH YEAR.

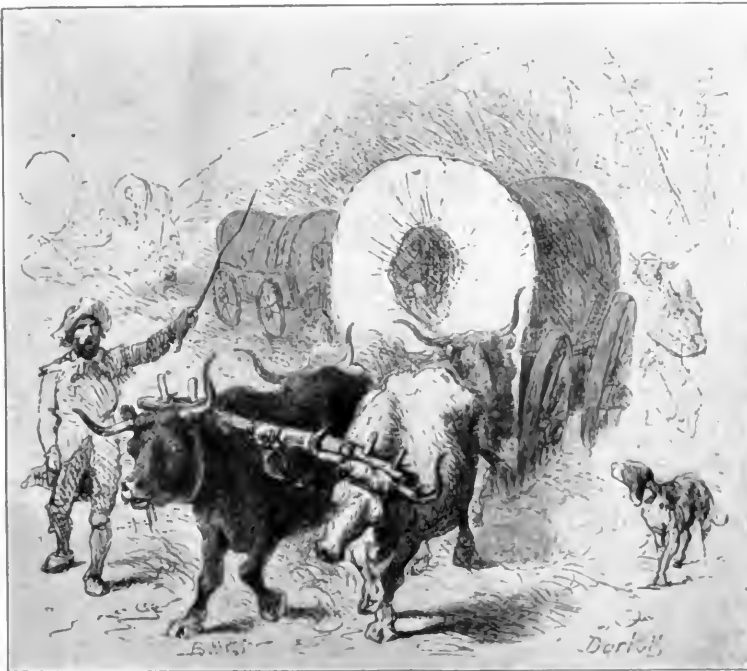

THE birth of the Rich West is one of the most romantic stories in American life. It is the chivalrous tale of the conquering of mountains and canyons, of forest and wilderness, of savage men and more savage beasts. It is but forty-two years ago that the writer of this narrative passed through the experiences here described, and to-day this same path-

less wild is aglow with untold wealth in precious ores, vast timber lands, and rolling fields of grain. Montana, the scene of this action, is alone contributing three hundred million pounds of copper annually, and gold and silver treasured at nearly twenty-four million dollars yearly, while its dense forests of more than twelve million acres are almost priceless in their riches and its Great Falls offer water power three times that of Niagara.

Reminiscences of a Montana Judge

RECEIVING from President Lincoln in March, 1865, my commission as one of the three United States judges of the Supreme Court of Montana, I began preparing for the start into the American wilderness in the service of my country. I will relate the incidents as I experienced them.

The discovery of gold in Montana in 1863 and 1864, had attracted widespread attention, and people flocked there in wild enthusiasm at the prospect of speedy wealth, apparently dreaming that a trip there would be equivalent to a life-time of ease and luxury in golden dreams. Crime was rampant with no laws or courts for its restraint.

Congress, to meet the emergency, provided for a territorial government over the country, by act approved May 26, 1864. Under this act as a political division of territorial area, Montana was larger in extent than all the six New England states, New York, New Jersey, Delaware and Maryland combined.

At this time no railroads crossed the continent, and it was unsafe to travel in those western wilds, except in large well-armed parties, and even then the danger was great on account of the Indians who struck terror to all objects of civilized life in their surroundings.

Appointees for the government of Montana, in the summer of 1864, made rendezvous at Omaha, purchased their outfit, with three months' provision for the journey, joined an emigrant train for Salt Lake and started, arriving at Virginia City in Southern Montana late in the fall of 1864.

Here they found a large population seeking gold, and human life was a small obstacle in their way of getting it. Among this rough, lawless element, were as brave, true men as ever faced danger or met duty. Out of dire necessity a Vigilance Com-

mittee had been organized for protection, and for a time it was a question which would be cleaned out first, the committee or the banditti. It was a trying crisis for the future of the Territory. Adventurous men and women, long emancipated from restraints of home and the refining influences of virtuous society, who had followed camp life on the Pacific slope as long as it was safe to remain there, had come to Montana.

This committee, hardly knowing whom to invite in, or exclude from its councils, with resolute purpose, with physical bravery and moral courage that would have crowned them martyrs at the stake in any age of the world, went forward with their work. Detective agencies sent out, the network woven—and at a given signal the net was sprung, criminals arrested, and brought in from different points to a designated place, and there charged with crime—a trial took place, and five of them were hanged at one time. This was the most important day's work ever done in the Territory. Similar arrests, trials, convictions and executions were held, sometimes one, two, and three executions at a time, till between the twenty-first day of December, 1863, and the third day of February, 1864, a little over a month, at Virginia City and Bannack, twenty-four of these outlaws, including the sheriff and two of his deputies, were hanged by the Vigilantes; and eight others, including two attorneys who had defended the criminals at the trial, were banished from the Territory.

The sheriff and his deputy pals were in league as robbers of coach and passengers with gold consignments to the states. His official position gained information as to coach outfit, and if the outfit promised favorable results, the coach met with masked robbers and the robbery was completed. Success finally betrayed his ambition, and he was brought to view his ending at the end of a hangman's rope. The sheriff was a well-built,



LEFT BY THE ABORIGINE AND TREASURED TO HIS MEMORY



SIGNING THE TREATY WITH THE INDIANS IN A BARTER FOR HIS LANDS
FROM COLLECTIONS OF THE HISTORICAL SOCIETY OF MONTANA

Reminiscences of a Montana Judge

all-around confidence man, whose position disarmed suspicion and his punishment too long delayed. Vigilante execution was speedy, usually within an hour after conviction. After every execution, good people breathed freer; that is, those who could breathe at all, for it was found at the trials by proof, confession and otherwise, that these adventurers became insane with the greed for gold and over one hundred lives were sacrificed to their sordid ambitions. Conscience was temporarily stupefied by the stampede for riches. One victim at the end of the rope, confessed that it was quicker and easier to kill a man for his gold than to dig for it.

These trials were before a Vigilante jury, presided over by one of their number with dignity and decorum, with a conscientious regard for the rights of the innocent, as well as stern justice for the guilty. If on trial, suspicion was strong and evidence weak, the accused was given so many hours to leave the Territory, and if he did not leave within the time limited, he never left at all. No one, once warned, waited for a second call, and he asked for no days of grace to the time limited.

The history of the Vigilance Committee in Montana is so incorporated into its early history, that I feel justified in alluding to it as one of the necessary forces used to eradicate a greater evil. The conscious existence of this committee was a wholesome dread to evil-doers. It will be remembered that, at the time of this active work of the Vigilantes, there was not an organized court in the limits of the Territory, and not one East between the Rocky Mountains and Yankton, in Dakota, nearly one thousand miles distant.

When President Lincoln summoned me to Montana, I could gain but little information by correspondence or inquiry, as to the condition of affairs in the Territory—where I should be located when there—or the best way to

go. Deciding upon the river route, I shipped my library to St. Louis, taking a steamer there for Fort Benton, the head of steamboat navigation, three thousand miles distant by river from St. Louis, and it took over fifty days to complete the trip, yet our steamer was the crack boat on the river that season.

Passing Yankton, in the lower part of Dakota one thousand, one hundred and eighty miles by river above St. Louis, we entered a country filled with hostile Indians. Military forts and stockades were besieged by the redskins, and commanders of the forts tried to impress upon the captain of our boat the perils of the trip, and it required no stretch of imagination to guard against possible adverse experiences on the way.

Fort Rice, one thousand eight hundred miles above St. Louis by the river, had been surrounded by them for days, it not being safe for even picket men to venture outside the enclosure. Mooring our boat to the shore, Indians interpreted our arrival as reinforcements for the fort and they left. Colonel Reeves, commandant of the fort, showed us a poisoned arrow taken from the body of one of his soldiers who had died that day in great agony from its effects.

The pilot house of our boat was sheathed with boiler iron, with peep-holes to look out for safe navigation, and other precautions taken for safety. There was no security in traveling through the Indian country at that date, except in large, well-armed parties, and even then trains were frequently stampeded by the bold dash and dreaded war-whoop of the Indians, who swept down like an evil spirit of the winds to help themselves to the scalps of drivers and plunder from the trains. Many to this day remember how frequently the coaches on the overland route were attacked by the Indians, and how thrillingly graphic were the scenes described by those who escaped the peril.



A PIONEER SETTLEMENT IN THE LAND OF GOLD—MONTANA CITY IN 1864



AN INDIAN GRAVE ON THE TRAIL BEFORE THE INVASION BY CIVILIZATION
FROM COLLECTIONS OF THE HISTORICAL SOCIETY OF MONTANA

Reminiscences of a Montana Judge

At night our boat was anchored with sentinels on guard to prevent surprise or attack.

On our way up the river we encountered vast herds of buffaloes moving from southern to northern feeding grounds. The plains, at times, on either side of the river, were literally covered with them as far as the eye could reach. They came to the river-bank and plunged into the sweeping floods regardless of fear and swam to the opposite shore like veterans in their native element.

Such a sight will never again be witnessed by mortal eyes. The river was full of them; so full, that we were obliged on different days to stop the steamer to avoid being swamped by them. On one occasion a stalwart fellow became entangled in the wheel of the steamer, and in his efforts for release, ripped out some of the buckets of the wheel, necessitating repairs. Some fat heifers and calves were lassoed from the river and killed for fresh meat for boat supplies. Excitement on these occasions lifted us into pleasurable emotions regardless of possible events for the morrow. Each had its markings different from preceding days.

At times an old bullock which had often piloted the herd over vast prairies to better feeding grounds, being fought and gored by younger blood of the same gender, would lag behind on the plains meditating on the mutabilities of time. No king deposed from thronely power seemingly ever felt the force of adverse circumstances more keenly than these deposed monarchs from prairie ranges forty years ago.

A wolf finding them alone, would watch their movements, and sound his call for help, which being answered by others understanding the signal, would hasten to respond; and when a sufficient number had gathered, would attack and drag their victim down for a feast. These exhibitions were not rare in episode, but pathetic in exhibition. Wolves in

single numbers are cowards for attack, but when fortified by numbers are courageous and voracious till their hunger is appeased. It is wonderful how well understood is the language of beast and bird-life peculiar to their species, and how quickly they respond to the meaning of signals! Montana was full of buffalo, moose, elk, deer, antelope, bear, wolves, foxes, and other game, and rifles echoed results in trophies that garnished the menu of our table on the transit.

Buffalo hunting was exciting and perilous. A wounded buffalo would often turn upon his pursuers, and in his fury, horse and rider would go down to rise no more. Buffalo are powerfully built, with fourteen pairs of ribs to the ox thirteen, and courageous to the extent of their vitality.

In the timber that fringed the river bank, otter, beaver, mink and muskrat, splashed into the water on our approach. Lagoons and lakelets were alive with water-fowl that sported in security, apparently tame in their wildness.

Game birds and animals strutted in tempting attitudes before the gunner armed with breech-loading shot-guns, and the deadly aim of Winchester rifles often varied the menu at our cabin table with luxuries that would tempt the gods of epicurean habit.

Rivers and lakes were full of delicious trout, as pretty speckled beauties as ever tempted the eye, or tickled the palate of good old Isaac Walton, who hung up his fishing tackle without visiting Montana, and his facetious pen was lost to the description of celebrities in its waters; where a few hours of careless fishing would satisfy the ambition of any one, especially if he had to carry the catch far on his back. There is a tradition in Montana of a man on mule-back fording one of its streams, where the trout were so voracious that they bit the spurs of his boots and hung on till he reached shore,

NOTICE.

Each adult passenger is allowed 25 lbs. of baggage free. But neither Gold Dust, Bullion, Coin, Bank or Treasury Notes will be carried under the designation of baggage.

OVERLAND STAGE LINE.

Office of The Overland Stage Line.

Great Through Mails between the Atlantic and Pacific Oceans.
(BEN HOLLADAY, PROPRIETOR.)

Received of *Jacob [unclear]* *Boise City Sept 26. 1866.*
One Hundred, forty five the sum of *145* DOLLARS.
in full for his passage from Boise City
to Helena City in coach leaving Sept 27. 1866.

In consideration of the price paid for this Ticket, it is expressly stipulated and agreed between the holder of said Ticket and the Proprietor of the Overland Stage Line, that the said Proprietor shall in no case be held responsible for Loss of Gold Dust, Coin, Bullion, Bank or Treasury Notes, or other property of the passenger.

5 1/4

E. A. [unclear] Agent.

AN OVERLAND STAGE-LINE TICKET INTO THE GOLDEN WEST IN 1866

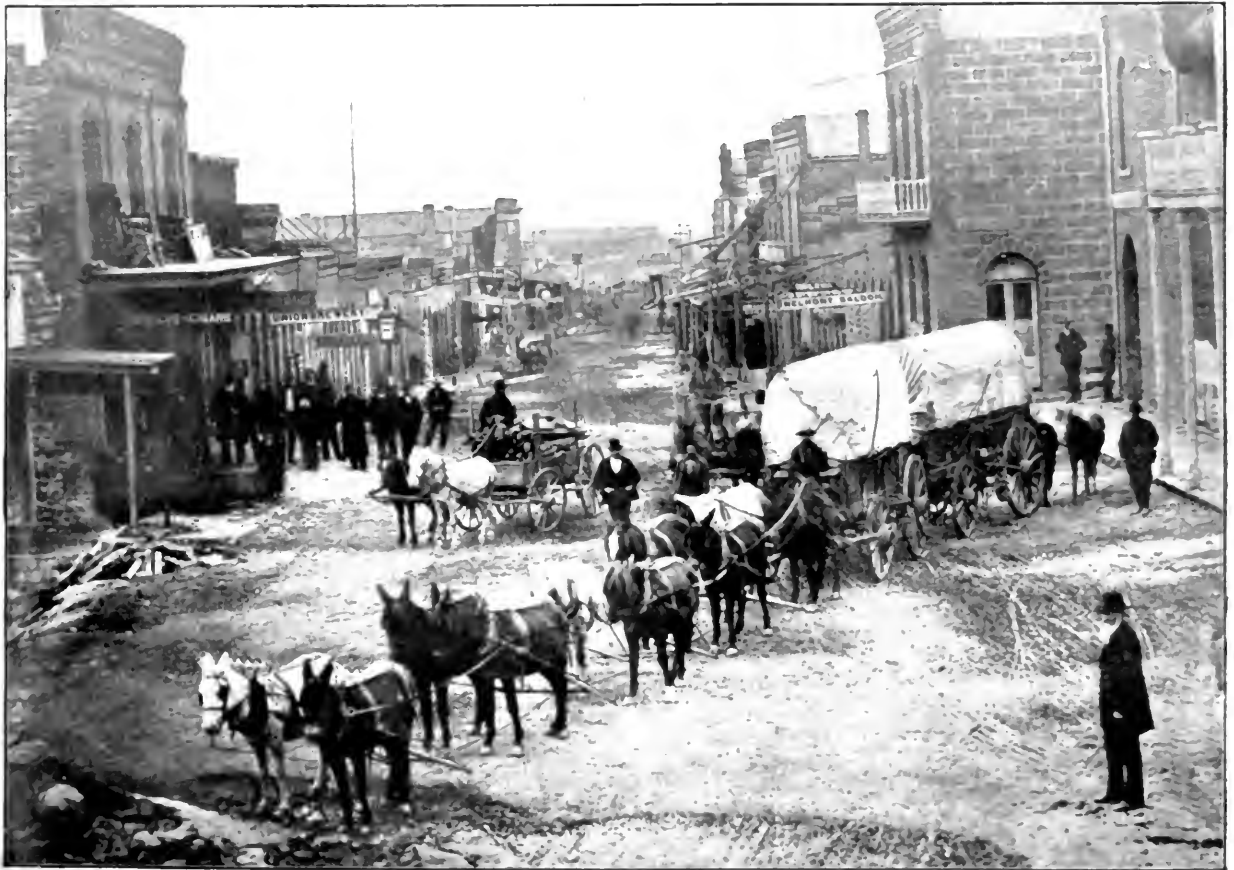

THE BIRTH OF A METROPOLIS—HELENA, MONTANA, ABOUT 40 YEARS AGO
 SOCIETY OF MONTANA

Reminiscences of a Montana Judge

and people repeated it as if they believed it true, and they were never hanged for speaking the truth.

A school teacher from Massachusetts, writing to the *Springfield Republican*, said that his fishing experience culminated when he reached Snake river. That he there "caught a brook trout that had a chipmunk and a mole in his stomach and still was hungry." "What do you think," said he, "of brook trout two feet, four inches long, with a nose four inches in breadth, a mouth like a good-sized shark, and weighing six and one-half pounds? You will not believe in such fish, but I assure you that Snake river is full of them, of incredible ferocity, and voracious to the last degree."

At Wolf Point, so-called, on the banks of the river, some woodchoppers had built a stockade to divide their time in cutting wood for the steamers, and trapping for furs, and it proved most profitable. They killed a buffalo—cut out what meat they wanted to use, and poisoned the carcass for the wolves. The first night seventy-two wolves came to grief. This was the largest wolf-gathering I ever saw. They had come in from prairie ravines and timber nooks for a feast, and they lay around the stockade on our arrival mid-day following their adventure, harmless of snapping teeth that glistened in the sun waiting the knife to separate their furry backs to fleshy coverings, which suggested comfortable robes for wintry days. An Indian would skin a wolf, surrendering its pelt to its captor for its carcass for his feast, regardless of the cause of its death and careless of his own mortuary record. The captain of our boat made arrangements with the stockade adventurers for the purchase of their pelts on his return, with as many more as they might capture in the interim.

River traffic in those days picked up much furry materials at local points on the river that did not enter into commercial reports, but their

markings in value on return trips were as great as on an up-trip adventure.

About one hundred miles below Benton, our boat grounded. On board as passenger was Major Upson, Indian agent at Benton, returning with annuity goods for distribution among the Indians connected with the agency. Some Indians came to the river bank who knew the major. He told them what he had on board which excited their vision of supplies, and gave one a letter to deliver with utmost speed to the agency at Benton. After a square meal for the start, and a sandwich for the way, the Indian started, leaving his three companions as hostages on the boat to await his return. Indians are fleet runners, and in two days from starting he had delivered his errand and returned. Three days later, teams appeared; the boat lighted of freight again steamed up the river. Strict surveillance was kept over the Indians on the boat till the Indian returned—only one allowed to leave the boat at a time for fear of treachery if they met other Indians.

Near Benton several persons, a few days before our arrival, were reported as massacred by the Indians. This soon after was retaliated by whites, when eleven Indians at one time, out of deference to Winchester rifle bullets, passed over into the spirit land, leaving their bodies and blankets on the ground, and their scalps fluttering on poles with night winds chanting a requiem over their departure.

After some delay at Benton we started with mule trains and prairie schooners for Helena, one hundred and forty miles distant. The trail was sufficiently marked to follow the way. We usually encamped for the night about mid-afternoon near a spring or water course. Wagons were drawn up in a circle, horses tethered out for grazing and a dinner prepared, sometimes stimulated by heat energies from dried buffalo chips, which was received with less



CHIEF YELLOW BOY GIVING PEACE SIGN TO
THE WHITE INVADERS—FROM THE COLLECTIONS
OF THE HISTORICAL SOCIETY OF MONTANA

Reminiscences of a Montana Judge

grumbling by the guest than are dinners served to major-generals from embalmed beef of modern notoriety.

At night, horses were brought into the enclosed circle for safety, passengers spread their blankets on the ground under the wagon for night's repose, trusty sentinels kept watch around the encampment, while the music of howling wolves in the near distance contributed to wakeful hours of nervous sleepers. Time wore away distance, and on Sunday, July 9, 1865, we arrived at Helena, then called Last Chance Gulch, owing to its discovery late in the fall before.

This was a lively camp; two thousand people were there, street spaces were blockaded with men and merchandise, ox trains, mule trains and pack trains surrounded the camp, waiting a chance to unload. The saw and hammer were busy in putting up cabins and store-houses, and in constructing sluice boxes for the washing out of gold, which was found in nearly every rod of its valley soil. Men who had shunned domestic duty over the cradle for years were rocking a cradle filled with dirty water, watching appearances of golden sands to open their purse strings to the realities of their adventure. Auctioneers were crying their wares, trade was lively, saloons crowded, hurdy-gurdy dance-houses in full blast; wild mustang horses, never before saddled or bridled, with Mexican riders on their backs, whereon man never sat before, were running, jumping, kicking and bucking to unhorse their riders, much to the amusement of the jeering crowd, and as exciting as a Spanish bull fight. "Buffalo Bill's" Wild West show illustrates in pantomime some of the stirring scenes and hair-raising proclivities of my first Sunday in Montana. It was a Sunday different from my early education in New England, and long to be remembered as a dividing line between Puritanical life and the wild scenes of Western activities.

There was suspended to the limb of a tree a man hung by the Vigilance Committee the night before, which was the eighth specimen of similar fruit encased in leather boots that tree had borne in as many months.

Saturday nights and Sunday mornings miners would come into town with their week's wages, and they would drink, gamble and dance till their money was gone, and then go back to camp after the excitement of the day was over, completely strapped, to renew the folly at another week's ending. Is it any wonder that such indulgence should blossom into crime?

At a conference with the other judges I spoke of this mode of midnight life-taking, and insisted that such cases should be noticed by the courts. One of the judges, understanding the necessity of sure, speedy work with the criminals, said: "I am content to let the Vigilantes go on, for the present; they can attend to this branch of jurisprudence cheaper, quicker and better than it can be done by the courts; besides, we have no secure jails in which to confine criminals."

The other judges coincided with him and said: "If you attempt to try one of those road agents in the courts, his comrades will get him clear, or if he should be convicted, the lives of the witnesses who testify against him, and of the judge who sentences him, will not be worth the shoes they wear." "Road agent" was a mountain phrase to designate highway robbers and perpetrators of kindred crimes.

A grand jury in one of the districts presented to the court in lieu of an indictment: "That it is better to leave the punishment of criminal offenders to the Vigilantes, who always act impartially, and who would not permit the escape of proved criminals on technical and absurd grounds."

My court opened the first week in August, 1865. In my charge to the grand jury, I took occasion to say that the court that day opened for the



NATIVE AMERICANS ON THE FRONTIER FORTY YEARS AGO



FIRST GOVERNOR'S MANSION—FIRST SCHOOL TEACHER—FIRST SCHOOL HOUSE IN MONTANA
FROM COLLECTIONS OF THE HISTORICAL SOCIETY OF MONTANA

Reminiscences of a Montana Judge

first time in that district for the trial of civil and criminal cases; and that, however satisfactory an excuse might hitherto have been for secret trials and midnight executions, no such necessity longer existed, and that all such proceedings must now be left to the courts.

The next day, three gentlemen, neither of whom I knew by name or sight, called upon me, and said that my charge to the grand jury was exciting considerable comment in the community, and asked about the language used. I told them it was on file in the clerk's office and they could see it there. That there might be no misunderstanding about it, I caused the whole charge to be published in one of the local papers and it was copied in other papers in Montana.

My next court term opened in December, 1865. A murder had just been committed. Through the vigilance of court officers the man was arrested and held for trial in the court. A rescue and summary punishment of the prisoner was threatened. The officers of the court, the jail not being secure, guarded the prisoner to prevent escape or rescue. At night the prisoner was taken from the jail to the court-room, where it was warm and comfortable for the officers on duty; one leg of the prisoner was shackled and secured to a staple in the floor. The officers, well-armed, remained on duty through the night in the room, while trusty sentinels patrolled outside to prevent surprise. This was more agreeable to the prisoner, who was afraid of rescue and summary punishment, than pleasant to the keepers.

No braver officers ever lived than U. S. Marshall George M. Pinney and his deputies, Neil Howie, John Featherston, and J. X. Beidler, and it gives me personal pleasure to accord to them the merit of having contributed largely to the establishment of order and good government over discordant elements in the Territory.

The grand jury, in attendance upon

the court, was charged upon the special work before them and upon such matters as might be the subject of inquiry. They found a true bill against the prisoner and were excused from further attendance upon the court. The prisoner was put upon trial for the offense charged in the indictment. Officers guarded him day and night. The verdict of the jury was murder in the second degree; no appeal taken, sentence passed, and in less than thirty days from the commission of the homicide the prisoner was serving out the penalty in the territorial prison at Virginia City.

The secretary, acting as governor of the Territory in the absence of the governor, while under the influence of an unfortunate habit, pardoned and set the prisoner at liberty. On being released from prison the man went back to Helena, swearing vengeance upon the witnesses who had testified against him. Arriving at Helena about nine o'clock in the evening, he was immediately surrounded by the Vigilantes and was hanged at ten o'clock with the pardon in his pocket.

This was the ninth specimen of kindred fruit that famous hangman's tree at Helena had borne in so many months. They all went up with their boots on, and as death found them, so the grave covered them. This trial in the courts for murder was the first ever held in the Territory, and it marked a new era in its jurisprudence.

If you would like to see how a man looked after graduating with the highest honors from a Vigilance institution, I will give you a verbal picture of this man as he appeared the next morning before removal from the sunlit tree to final rest beneath the clods of the valley. The remains were placed in a stainless board coffin on a dray cart drawn by a mule, the sheriff and coroner leading the way from the place of execution to the cemetery; no mourners shed tears on the way; no glove-handed pall-bearers



EARLY DAYS IN A MINING TOWN—HELENA, MONTANA
FROM COLLECTIONS OF HISTORICAL SOCIETY OF MONTANA

to do escort duty; no flowers on the coffin enclosing the remains; no religious ceremony over its commitment, and no monument marks his resting-place.

Vigilante rule worked in harmony with its precedents, with no artificial distinction of persons or in results. Speedy trial in civil and criminal jurisdiction metes out justice better when witnesses are fresh from the scene of controversy than to await their departure, or to depend upon India rubber memories which may be side-tracked into forgetfulness when the trial is reached. Eastern states' courts would profit largely by imitating Western promptness in court proceedings with less miscarriage from the pivotal point of justice, with less frivolous technicalities for delay.

There was one other trial for murder before me in August, 1866. This

man was arrested by the United States marshal for murder in the Indian country under provisions of United States laws; was tried on the United States side of the court and convicted of murder in the first degree. Sentence passed that he be remanded to prison and there safely kept, "till Friday, the fifth day of October, 1866, then and there to be hanged by the neck till dead." Officers of the law guarded the jail and prisoner day and night to prevent escape or summary execution. Record of arrest, proceedings, trial, conviction and sentence were forwarded to the president and attorney-general of the United States.

President Johnson commuted the sentence to imprisonment for life, and ordered his transfer to Detroit prison, Michigan, to serve out the sentence. On his way thither, he escaped from

Reminiscences of a Montana Judge

his keepers and was never delivered there.

I recall another case. The head manager of a large quartz mining company for the reduction of gold ores near Helena killed a man for alleged stealing of wood, cut for milling purposes. This wood was cut on government land, the title to which remained in the government. The man was arrested, jailed, indicted by the grand jury, and held for trial. Pending trial, the prisoner took change of venue to a sparsely settled county in another district jurisdiction. On the trial the prisoner was discharged and he left Montana under cover of midnight hours and was never seen there afterwards.

After I left Montana, I learned that four other persons were hanged by the Vigilantes upon that famous Helena tree, thirteen in all, when a clergyman, ostensibly to reform the morals of the community, cut the tree down, and when it was safely housed, peddled it out for canes, and that tree became as famous for the number of canes it produced as it had for the number of persons who had cast their last look up among the branches before testing the strength of its fibers at the end of the rope. From twelve to twenty-four hours of good hanging was generally considered long enough to warrant a certificate that life was extinct and the body ready for burial.

Soon after my arrival in the Territory, I received a letter from a medical graduate of Yale, stating that he had graduated with honor, was devoted to his profession and anxious to settle in a new thriving city, and inquired if Helena was such a place. Meeting one of the worthy doctors of the city, I handed him the letter and asked for information.

Said he: "Tell that young man not to come here, for men are seldom sick and never die," and with a quizzing look into the face of the gentlemen by his side said: "The Vigilance Committee had to hang a man in order to start a grave-yard." Whereupon the

gentlemen addressed replied: "The reason of the delay in starting one is not so much owing to the want of sickness among the people as the lack of skill among the doctors." Honors being easy between them, the conversation was not continued.

Vigilantes, as a rule, filled the hiatus between early settlements, the establishment of courts and organization of civil government over the Territory. They can look back over a generation of stirring activities in her borders with a consciousness of duty well performed in its early history.

Hopeful and active for its welfare under shadowy clouds in its morning life they were efficient and watchful in the sunshine of its prosperity, in social, political and commercial maturity. History overlooks some faults to embellish the memory of the faithful. Vigilante rule in the early life of Montana may have had cloudy spots upon its disk, but its general record illumines its history as a necessary force in the cycles of time.

The first Montana legislature in 1865 failed, under its organic act, to make provision for its successor and its legislative functions lapsed, necessitating affirmative action by the government at Washington. Without waiting that action the acting governor (the governor being absent from the Territory), in February, 1866, under some fancied pressure, issued a proclamation ordering an election of delegates and convening the legislature in March, 1866, which proceeded to the business of law-making for the Territory. Its pretended laws and franchises were early before my court for consideration and were adjudged void and of no validity.

Court records, with legislative proceedings, were transmitted to the president and by him referred to the attorney-general of the United States, who sustained the ruling and decisions of the court, adjudged the legislative proceedings void, payment of expenses of the legislature refused,



THE FIRST RAILROAD TRAIN INTO THE GOLDEN WEST
FROM RARE PRINT IN POSSESSION OF JUDGE LYMAN E. MUNSON

and its reputed laws expunged from the statutes of Montana. Executive, judicial and legislative jurisdictions settled down in harmony, and peace and prosperity ruled the Territory.

The Montana Bar was composed in the main of well-educated, good lawyers and accomplished gentlemen, some of whom had held judicial positions in the states before going there. They were loyal to their profession, to the courts, to the commonwealth, and their influence did much to bring order out of chaos and establish good government for the people.

Many families emigrated there for future homes. Fond mothers had said in the language of Ruth:

“Whither thou goest, I will go,
Whither thou lodgest, I will lodge,
Thy people shall be my people,
And thy God my God.”

The presence of virtuous women inspired rough miners with respect, and their gentle administrations to the wayward were like merciful visitations to the doomed.

In October, 1865, in company with the governor, and an armed escort,

we started from Helena on horseback for Benton, one hundred and forty miles distant, to help the Indian agent make a treaty with the Indians and witness the distribution of annuities. At this time three log cabins, two occupied by French half-breeds and one by an American, were the only stationary evidence of civilized life on the way.

The first day we reached the ranch of Malcolm Clark, an American living with his two squaw wives of different tribes in his cabin home. Horses and mules carrying our camp outfit were relieved of their burden and picketed around haystacks for forage. Supper ended, we retired for the night under a shed, provided our horses from storms which came up suddenly and raged furiously while the storm-king tarried, rolled ourselves up in our blankets with trusty rifles loaded by our sides for emergency and took a quiet sleep while midnight sentinels patrolled the camp. Morning sunlight was propitious for a pleasant day's journey.

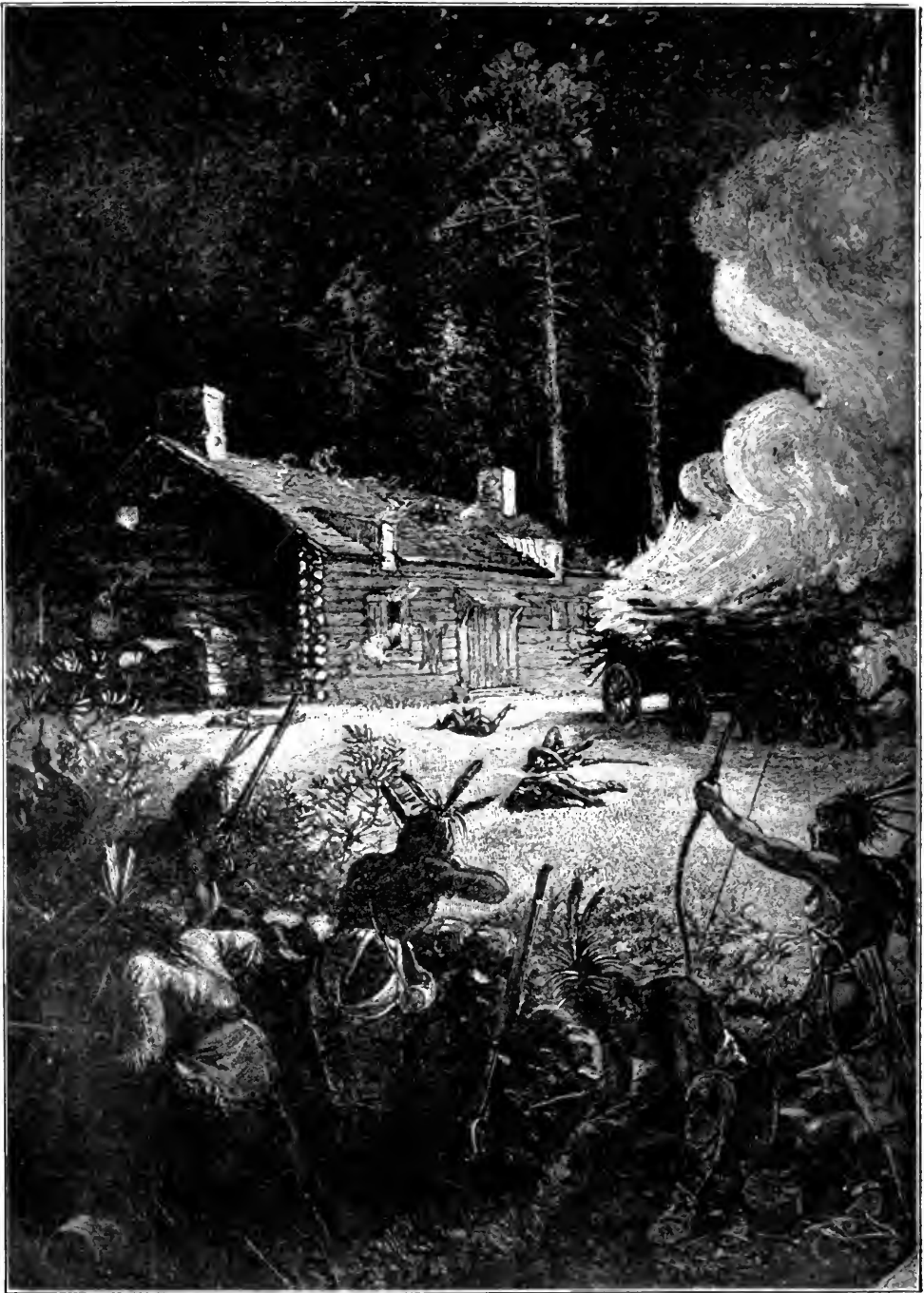

THE FIRST AMERICAN'S PROTEST AGAINST CIVILIZATION
FROM RARE PRINT IN POSSESSION OF JUDGE LYMAN E. MUNSON

Pioneer Life on American Frontier

Clark was a graduate of West Point and worked on the fort and storehouse at Benton for the American Fur Company, of which John Jacob Astor was the head. He claimed that his wife and children were entitled to a share in the distribution of the annuities and in the morning he joined us for the balance of the journey. During the day a snowstorm struck us and we housed for the night in the cabin of a Canadian half-breed, before spoken of. An Indian hunter for the cabin had brought in a mountain sheep and we feasted on delicious morsels from its juicy sides. After the repast we rolled ourselves up in blankets and lay round on the ground floor with heads and points at promiscuous angles. Still snowing in the morning, it was decided to detour from the regular route and visit the Catholic mission some fifteen miles distant.

Clark, understanding Indian, engaged the hunter as guide, they leading the way over the trackless snow and we following. Reaching the mission, we were cordially received and generously entertained over two nights and a day. In the morning, taking a guide from the mission to pilot our way to the Great Falls of the Missouri river, we encamped there for the night amid the roar of mighty waves pouring over a rocky precipice nearly eighty feet in perpendicular plunge. A dead tree with naked branches tempted the advent of an ax from the outfit, and that tree with its fiery outlines was very companionable and midnight hours sparkled with wit and repartee, now lost to memory.

The next morning we started for Benton, arriving there in a snowy coverlet mantling the earth from five to six inches in depth, at the close of a six-day journey from Helena. On our way we daily saw large bands of deer, antelope and elk, which, at the sight of our cavalcade, fled into safe distance, wheeled about and faced us like a military company on parade,

watching our movements in retreating distance.

At Benton we met about seven thousand, five hundred Indians composed of different tribes gathered there in expectation of great results. Indians claimed all that country as theirs. Indian tepees fringed the hillsides and pioneer cabins dotted the valleys. The bow sped the arrow for game and other trophies and the crack of pioneer rifles echoed from valley to hilltop. Antagonistic forces contended for mastery over the situation, but civilized agencies had its innings and chaos its outings in a battle well won for the former and defeat for the latter. Human life was unsafe and cheap on both sides. A good opportunity for skill in marksmanship with either rifle or bow and arrow was frequently rewarded with bloody trophies.

We made a treaty by which the Indians were to give up their coveted lands, the land of their fathers, the gamiest country in the world, and go onto a reservation on Canadian borders, and we distributed to them about \$7,500 in annuities, ostensibly one dollar for each Indian, squaw and papoose. These annuities consisted of dry-goods, groceries, hardware, etc., suitable to necessities, wants and desires of the Indian. It required on the part of the agent care and judgment to measure and cut, weigh and divide for distribution so as not to excite tribal jealousy, a marked characteristic in Indian character.

During the distribution, Indians were seated on the ground in Indian fashion, each tribe separate and apart from other tribal groups, all facing the center of a square, where the goods were placed for distribution. The chiefs, as mark of special favor by the agent, were presented with extra gifts and provided with chairs in recognition of tribal distinction, which flattered their vanity as possessors of thronely power.

It was a panoramic scene of tribal costume, interlaced with painted faces

Reminiscences of a Montana Judge

and fantastic paraphernalia of tribal ornaments, requiring the graphic touch of a painter's brush on canvas to convey a realistic impression, nowhere to be reproduced by pen and ink descriptions. It was the enchantment of a divine reality moving over the canvas of passing events never to be effaced from memory's tablet.

Chieftain costumes, indescribable in fantastic exhibit, down to the bare-footed papoose in the lap of its mother, the transition stage was gradual with no apparent jealousy to mark the outfit in gradation of fashion-plate colorings. These scattered tribes of Israel retain characteristics of their nationality. Tribal jealousies still mark the instincts of ancestral life on the plains of Judea, transferred to American soil, before the ships were built that brought Columbus to our shores. Robbed of peaceful possessions and life pursuits, they are in the environments of the Nation's power, and should be generously provided for by beneficent, impartial, life-sustaining agencies before being forced into the horoscopic circle of extinction now clouding their inheritance and foreshadowing their destiny.

The distribution of annuities ended apparently satisfactorily with peaceful outlines and the next day we started for Helena on our return trip and camped about twenty-five miles out for the night, with several merchandise trains moving to trade centers in Montana. About midnight, a messenger with horse foaming with sweat, arrived, bearing a dispatch from the Indian agent at Benton to the governor. The message was that war had broken out between two treaty tribes on agency grounds, that the lives of the people, government stores and agency buildings were in jeopardy and to return at once.

Attached to one of the trains was a brass cannon on the way to Virginia City. Governor Meagher, quick in perception, and efficient in emergency, pressed the cannon into service and at two o'clock at night we were on our

way back to Benton, arriving there at sunrise, much to the relief of the people, after a sleepless night and anxious forebodings of the day, and news of our arrival spread over the surroundings from camp to camp. The cannon was drawn up before the agency building, loaded and shotted to its muzzle with musket balls for instant service, with no secret from observation or of intention.

The governor, his aids, Indian agent and interpreters, walked out to one of the camps, called the chief and head men for an interview. They appeared in war paint as red as the blood in their veins, with black stripes as hideous as dragons' teeth on their faces.

The governor said to them that hearing of this disturbance he had hastened back to be in the fight and if the chief and his men did not leave the agency grounds before noon that day, he would open fire upon them and not stop till every Indian was killed and annuity goods restored to the government. That they might know the time limited he stuck his cane in the ground and said that when the sun's shadows fell upon the other side of the stick the time was up and no delays would be granted.

We next went to the other camp where he repeated the same warning. Both camps were in belligerent attitudes. Trenches dug and breastworks thrown up; women, children and goods removed to safety; two hundred Indian warriors in each camp in war-paint; guns and arrows, spears and tomahawks, scalping-knives and battle-axes were no pleasing attributes to contemplate when the balance of numbers were largely against us. It was a day of anxiety, measured by hourly reports from the camps. Hopeful signs of evacuation during the day appeared and at night the curtain dropped in peaceful lines over the landscape, camps deserted, and the angel of peace celebrated a bloodless victory over what had appeared to be one of bloody carnage.

Pioneer Life on American Frontier

Each Indian has its head and lesser chiefs who rule the policy of the tribe with more rigor than the governor and statutes do their constituents in the states.

During my three or four weeks' stay there I saw Indian character in full development in many of its phases. Tribal chiefs in gay attire, in war-paint with eagle feathers and wampum, with necklaces of polished bear claws and wolf teeth that glittered in the sun and rattled with their movements, with bows and arrows, tomahawks, scalping-knives and trophies of war, saw them on the war-path, heard the war-whoop, saw them in the war-dance, in the pow-wow around their dead brave, in the burial ceremony, around council fires, in the wigwam, on the field, in the chase, in their ceremonial rites to the Great Spirit, in their hunger and in their feasts; have smoked with them the pipe of peace, have tasted the aroma of roast dog in the wigwam of the great chief, with one hundred yellow bucks with hungry mouths around the tent watching movements of the feast within, have confronted them with weapons of warfare in the hour of danger, and I declare, that in their nomadic state, measured by standard ideas of civilized life, the mind cannot escape the conviction that they are a degraded, indolent, treacherous race, with no manly attributes of character worthy of poetry, song or tradition.

Over and against this estimate of their character much should be placed to their credit. This was their country, the land of their fathers, where sleep their brave dead. The Great Spirit had presided over their councils and had given them an abundance of game at all seasons of the year. Success attended the chase. Horses, dogs and papooses multiplied to the tribes; they were happy and contented in their seclusion and prosperous in their ways. But the Chinese walls of isolation were being broken

down, men poured into their country by the thousands from all directions

"They came as the winds come,
When forests are rended;
They came as the waves come,
When vessels are stranded."

and they felt the situation keenly. The handwriting to them was on the wall. Beyond the realms where lightning flashes and thunder rolls the shining stars shot the shadows of their fate athwart the heavens and they read their doom in the evening sky and comprehended the reality amid the stirring scenes before them.

Whittier has said:

"I hear the tread of pioneers,
Of Nations yet to be;
The first low wash of waves, where soon
Shall roll a human sea."

This prophetic vision by Whittier was not understood in its full relation to Montana till the prophecy burst into full realistic vision.

Forty steamers that season unloaded men and merchandise at Benton. Ponderous trains of merchandise and strange devices of machinery were moving across the country, cities were springing up as if by magic, the government was there with its officers collecting its revenues and enforcing its laws; game was unmercifully slaughtered and frightened from its ranges; a new order of strange proceedings to the Indians was being established in their midst and they felt that their occupation was gone and it was gone forever.

A letter from one of the principal mercantile firms at Benton informed me that as late as the years 1874, 1875, 1876 and 1877, there were annually shipped from Benton to the East eighty thousand to one hundred thousand buffalo robes; thirty to forty thousand mountain wolf-skins; one hundred and twenty-five to one hundred and fifty tons of deer and antelope skins, besides beaver, otter, mink and other choice furs, aggregating some years in value to more than a million of dollars.

After 1878 the numbers dwindled

Reminiscences of a Montana Judge

rapidly until 1884 when hardly one thousand robes were brought to market; and now not one buffalo left, and to extinguish the last vestige of them the white man is gathering from the plains the dried bones and shipping them to bone mills to be ground into fertilizers.

Under this tremendous slaughter by the Indians, game seemed to multiply, or at least to hold its own, but when the white man appeared, it began to decrease, and now not a buffalo roams anywhere on the plains from Mexico to Canada.

A few are protected by the vigilant care of the government in the National Yellowstone Park, to preserve their species from extinction, but they do not thrive under domestic habit. A few may be seen on exhibition in menageries, and in confined, fenced-in preserves, but they exhibit but feebly the characteristics of the buffalo as he roamed over the continent forty years ago.

The bow and arrow was not the only destructive agency in game surroundings. Civilization marked its bloody tracks in many ways and the Indian read his doom on the lines of passing events. The lesson was severe to contemplate, but emphatic in results. With the loss of game to the Indians came also the loss of profits to the merchants. The old trading post of the American Fur Company at Benton with its thrilling history has been abandoned, its walls fallen to decay, bats nest in security upon shelves where rested from time to time millions of dollars in furs, and the hoot of the owl breaks the silence of midnight hours where once echoed the busy hum of commerce.

The game is gone and the Indian is going. His proud spirit is broken, his erect, stalwart form is bending to the shadows of inevitable fate, his step trembles upon the threshold; he is passing away from the march of civilization like dissolving snows from the breath of morning. The waves of civilization have crowded him back

from sea-girt shores to the rivers, from the rivers to the plains, from the plains to the mountains, from the mountains to the shadow-land beyond the cycles of time.

The problem of dealing with these poor people, now but remnants of once powerful tribes, is a humane one, and the government cannot too promptly awake to its importance, and, with a liberal hand, lighten the shadows and avert the sorrows that environ them. They are fast becoming but a memory of traditionary realities.

"There's a spirit on the river; there's a ghost upon the shore;
They are chanting, they are singing through the starlight evermore,
As they steal amid the silence and the shadows of the shore,
You can hear the ringing war-cry of the long forgotten brave
Echo thro' the midnight forest, echo o'er the midnight wave,
And the mystic lanterns tremble at the war-cry of the brave."

The relation of husband and wife was that of autocrat and servant. An Indian suing for the hand of a comely squaw had a poor chance of success, unless bravery attended him in the chase, or in prowess of warfare; and even then, he often had to gauge his desires by the number of horses he could give the father in exchange for his daughter, the horse being the standard of relative values the same as stocks and bonds in civilized life.

As to faithfulness of their marriage vows statistics give no data. The rules and laws of the tribe discriminate largely in favor of the male. The wife and daughter, so to speak, is owned by the husband and father. If the wife, overtaken in violation of one of the commandments without consent of the husband (and such consent was sometimes given by the husband as a mark of favor), if she escapes punishment by death her face was often disfigured for life and then banished from her husband's tent with no mystic seal of court records paraphrasing causes of matrimonial

Pioneer Life on American Frontier

infelicities. I have never seen such disfigurement upon faces of the males, but such absence should not be construed as freedom from similar indulgence.

Mormon doctrines, to some extent, found favor among the chiefs and high-toned bucks of the tribe, although I never heard that they claimed special revelation from the spirit-land enforcing it as a religious observation. Chastity and sexual commerce in Indian character is at no lower ebb than in civilized life in the states; indeed, the percentage of concubinage in commercial centers of civilized life in the states is greater than in tribal centers of Indian life.

Some Indians dispose of their dead by elevating their bodies upon a scaffolding of poles about six feet from the ground, above the reach of wolves and beasts of prey, wrapped in blankets or robes with tribal ornaments about the person. These subjects are never disturbed by Indian hands, though the glittering ornaments so much coveted in tribal life should drop upon the ground. The sight of one of these "burial grounds" would have been an inspiration for a surgeon's dissecting knife in other parts of the country without screened doors or peep-hole observation.

I have mentioned Fort Benton earlier in my article. It was not a military fort, but a trading post, established by the American Fur Company and was one of the most important on the river, if not in the whole country. From this point alone more than half a million dollars in furs and robes were annually shipped to the states.

The store-rooms and work-shops were built of adobe bricks of much strength, with port-hole turrets for lookout and defense. These buildings again were surrounded by a stockade of high poles together, one end embedded in the ground, and the other riveted in their fastenings at the top, giving ample room in the enclosure for storage and made capable

of resisting attacks by the Indians in any mode of warfare then known to them. A large gate in the stockade opened to the enclosure, through which Indians passed in limited numbers at a time, chiefs and head men first, to exchange robes and furs for paint, beads, gaudy calico and red blankets, so attractive to the race. As soon as one squad had finished trading they were turned out to make room for others to enter, who had remained outside the stockade waiting opportunity, it not being prudent to let too many in at a time, besides being inconvenient to accommodate a whole tribe at once for want of room.

The exchange price for a good buffalo robe, formerly, was a cup of sugar, a yard of calico, string of beads, or a little red paint, with a plug of tobacco added, for an extra nice robe or a choice lot of furs. If an Indian could get several coveted articles in exchange for one, the traffic was reckoned by them to be largely in their favor; numbers often offset values.

These robes were dressed and tanned by the squaws and by them brought to market, either upon their own backs or upon the backs of ponies, with papooses in the outfit astride of the bundles or on the necks of the horses as conscious of life's realities as the owner of an automobile on the back seat of his "red devil flyer" is conscious of unlawful speed over his transit. The squaws formed the baggage train of the moving camp, while their master lords rode in stately ease, oblivious of all care or responsibility for the drudgery of the camp. All the labor among the Indians, except the chase, was performed by the squaws. They did everything, took care of the babies, moved the camp, pitched the tent, cut the wood, brought the water, dried the meat, dressed the pelts, cooked the meals, and when the repast was ready first served their masters, contenting themselves with the scanty refuse that might be left.

Reminiscences of a Montana Judge

The White and Indian races, separate in life's pursuits on the line of human destiny, the weaker has given way to the stronger, under the shadows of inevitable fate.

I have spoken generally of the Indians in their nomadic state, and not in their enforced colonization upon reservations, where they are kept in subjection by the power of the government, contrary to the impulse of their nature. The difference between the two conditions is much like that of a tiger caged for exhibition in the menagerie and in the jungles.

During my early residence in Montana gold dust was the circulating medium in which contracts were made and purchases were settled for in this commodity. Each place of business had its little scales where balances were adjusted. Gold dust had a commercial value of \$18.00 to the ounce the same as gold coin, and it took thirty or more crispy greenback dollars to equal the purchasing power of an ounce of gold dust.

In the saloons and hurdy-gurdy dance-houses, where whiskey was sold at thirty and forty cents a drink, the beam of the scales went down with the weight of gold as rapidly as the whiskey went down the throats of the drinkers. It was easy to tell which had the advantage in this exchange. Sometimes a looker-on, seeing the size of the drinks, would conclude that the drinker thought himself a long way ahead in the exchange and the oftener he drank, the more sure he became that such was the fact.

Miner's wages at that time averaged \$8.00 to \$10.00 a day, payable in gold dust. This gold was carried by them in a leather pouch of pliable deer-skin, and not unfrequently the bartender, when patrons became mellow and oblivious to care, would dip his finger and thumb into the sacks, take out a pinch of the yellow stuff and drop it into his till without weighing. An avaricious pinch would bal-

ance the value of eight or ten dollars in greenback currency.

I watched the transition stage from Indian and Vigilante rule to law-abiding precepts established by the courts and co-ordinate branches of the government, and the Territory passed into channels of state sovereignty among the sisterhood of states on the twenty-second of February, 1889. Montana in its uplift out of "swaddling clothes" stands full-dressed in the sunshine of activities in the destiny of the republic.

The power and dread of the Indian is gone. Their contact with civilization, with its arts and sciences, weakened their power of resistance to aggressive forces; they are but orphans on the fly-wheel of time, driven to reservations distasteful to their nature, surrounded by government bayonets to enforce obedience to government demands.

Cattle, horses and sheep roam in fatness and contentment on the hills and in the valleys. Christian homes dot the landscape, golden harvests gladden the fields, routes of travel are improved and safe. Railroads with their branches reach up into Montana for its commerce, with palace-cars for comfortable travel running through Helena, the capitol of the state, and on to the Pacific ocean. So that now we can take the cars to New England, and with but few changes ride to the fields of gold, copper, silver, and other mines in Montana with ease and comfort, visiting the Yellowstone Park, Nature's wonderland, unequalled in marvelous natural wonders on the globe. Churches in Montana are well filled on the Sabbath, schools provided with accomplished teachers, society good, and life as secure as in other states. Trolley cars fly on electric wings over mountain and valley, delivering messages from point to point with the regularity of clockwork, while the wireless telegraph annihilates time and distance in its circuit around the globe.

The Indian, on his fleet-stepping

Pioneer Life on American Frontier

horse, with flashing spear, battle-ax and implements of warfare, has given way to the pale-faced rider on a steam-chested iron horse with speed that defies the whirlwind and fears no obstacle in its way.

Emigrant trains, the post-rider, the stage-coach, are vanquished by the power of steam and electric forces, guided by intelligent agencies that rule the world and bridge the skies.

Old theories and moving powers are substituted by new agencies in life's activities and the springtide of the new century is budding to flash sunlight over the world that will emancipate the social, political, commercial and religious environments that encrust them. In the uplift, man comes into sublimer relations to creative power than prophets foresaw, or seers foretold. The past is but an epitaph on the tombstone of time; the future will be living history. The star of Bethlehem that shone for only a few wise men to gather at the manger to-day shines with increased luster for all men to worship at its shrine and we are on the threshold of greater events in the problem of life than ever before.

The president of the United States on the Fourth of July, 1903, by telegraphic and cable news startled the slumbers of kings and queens in their morning naps by "good-morning salutations" which echoed around the world in twelve minutes and ten seconds, returning with responsive acknowledgments over a circuit of nine thousand miles through ocean waters and over mountain summits, annihilating distance and sanctifying thought that reached from the throne of light to the heart of man.

The rainbow of promise bends from the Throne of Power to the ear of man, revealing secrets and new agencies soon to burst upon us; the bow-

els of the earth give up their enveloped history, the ocean becomes a sounding-board for midnight dreams among the nations, and morning sunlight flashes through inky type, the maturing of plots in isles of the seas, and the moving of armies in distant nations of the earth are photographed over our menu at the breakfast table. Electric words from land shores jump into wireless aerial chariots and in the twinkling of an eye dance upon decks of ships hundreds of miles distant, revealing to the selected eye secrets that astonish the world.

The star chamber of destiny opens its gates and gives us a free ticket to gather at the passover of coming events. The cradle of to-day is rocking elements that will startle the world to-morrow. Rip Van Winkle slumbers are at an end. The twentieth century awakens new-born activities; morning sunlight illumines the night of slumbering energies; science lifts its torch revealing new attributes from starry realms; theology breaks the shell of long encased dogmas; medical skill moves away from blood-letting facilities which nourish and sustain the tissues of human life; the law abolishes its shield on the equity side of party litigants; American energies sweep the decks of the world's commerce; the nations stand aghast at the attributes of American achievements on the line of progressive events.

Railroad bands of steel girdle the earth's surface by American push; our sails whiten the seas, steamboats plow ocean waves, gathering to their decks the commerce of the world. There are no shady nooks for lethargic dreams by the wayside in the whirl of passing events.

"Life is real, life is earnest," and no manna from heaven need be expected to drop into the basket of the slothful.

" We'll tread the prairie, as of old
Our fathers salled the sea,
And make the West, as they the East,
The homestead of the free "

The First American Soldiers

Call "To Arms"

Began with the Arrival

of First White Men in the New World *

Footmen with Musket and Pike * Horsemen with Pistol

and Carbine * Military Force Blazed Path for Civilization *

The First "Trained Bands" and the Organization of the Continental Army

BY

SPENCER P. MEAD, LL.D.

of the New York Bar

*AUTHOR OF THE HISTORY AND GENEALOGY OF THE MEAD AND REYNOLDS FAMILIES IN AMERICA

THE earliest colonial settlers in this country found it necessary to form and maintain military organizations for their protection from the Indians and other marauders, which were designated "trained bands" and were called into active service at different times during the colonial period as the exigencies which confronted the colonists required.

In Virginia, Captain John Smith commanded the military force for a number of years, and under his efficient leadership it proved indispensable to the preservation of that colony. The military forces of the Plymouth Colony were commanded by Captain Miles Standish, who, in 1621, commanded a strong party of fourteen men against the Indians and on the twenty-ninth day of August, 1643, was appointed captain by the General Court, and in 1649 he was commandant of the several military companies within the Plymouth Colony.

The Massachusetts Bay Colony in 1631 ordered that "every man with a musket shall have ready one pound of powder, twenty bullets and two fathome of match, and that every captain shall traine (drill) his company on Saturday in every week. General training days once a month at one o'clock in the afternoon." In 1637, general training days were reduced to eight times in a year. In 1636, the

General Court held at Boston, ordered that the military companies be divided into three regiments; that all freeman be allowed to vote for officers of a trained band; and in 1645 ordered that the chief commander of every company is authorized to appoint out and to make choice of thirty soldiers of their companies in every hundred, "who shall be ready at halfe an hour's warning upon any service they shall be put upon by their chief military officer." The organization of these emergency men was continued for generations, and later they became the famous minute-men of the Revolutionary War. There has recently been organized, in order to perpetuate the memory of the minute-men and also to promote patriotism, an association known as the "Minute-men," with headquarters at Washington, D. C., and divisional commanders located in different sections of the country. In 1642, provisions were made for fines and punishments for disorderly soldiers, and in 1648 arrangements were made for regimental drills and a troop of horses was organized.

The Connecticut and New Haven colonies likewise organized military companies, or "trained bands," as they were called, and in 1636 ordered "that every plantacon shall traine once in every month and if upon complainte of their military officer, it appears that there bee divers very unskillfull, the saide plantacon may appoint the offi-

Organization of the Continental Army

cer to traine oftener the saide unskillfull. And that the saide military officer take view of their severall arms whether they bee serviceable or noe. And for default of every souldiers absent the absent to paye five shillings for every tyme without lawful excuse within two days after, tender to the commissioner, or one of them in the saide plantacon. And for any default in arms upon warnings to them by the saide officer to amend by the tyme appointed one shilling every tyme. And where arms are wholly wanting to be bounde over to answer it at the next Corte."

First American Homes Were Arsenals Under Penalty of Law

Captain Mason, in 1637, was appointed a public military officer of the plantations of Connecticut to train "the military men thereof in each plantacon according to the dayes appointed and shall have £40 per annum, to be paid oute of the Treasury quarterly. The pay to begine from the day of the date hereof, to traine the saide military men in every plantacon tenn days in every yeare, soe as it be not in July or August, giving a weekes warning beforehand." All persons to bear arms that are above the age of sixteen years, except those exempted. A magazine of powder and shot to be kept in every plantation for the supply of the military men, and every military man is to have continually in his house in readiness "halfe a pounce of good powder, two pounds of bullets sutable to his peece, one pounce of match, if his peece be a matchlocke, and whosoever failes of his halfe pounce of powder and two pounds of bullets and match to pay five shillings for every tyme that is wanting." Later training days in the plantations of Connecticut were reduced to six times in a year, and the General Assembly enacted, that "there shall be in each Plantation within this Jurisdiction, every year at least six Training days, or days of public military exercises to teach and instruct all the males above

sixteen years of age in the comely handling, and ready use of their arms, in all postures of war, to understand and attend all words of command."

An extract from the report of the governor of Connecticut to the home government, dated the fifteenth day of July, 1680, reads as follows:

"For the present we have but one troope settled, which consist of about sixty horse, yet we are upon raising three troopes more, one in each county of about forty horse in each troope. Our other forces are Trained Bands. There is a major in each county, who commands the militia of that county under the governor for the time being, who is the General of all the forces within our Colony. The whole amount to 2507. The names of the several counties are:

Hartford County	where are about	835	trained soldiers
New Haven	" " " "	623	" "
New London	" " " "	509	" "
Fairfield	" " " "	540	" "
		2,507	

Our horsemen are armed with pistols and carbines. The foot soldiers with musket and pike. For the present in our late warrs with the Indians, we found dragoones to be most usefull and therefore improved about three hundred of these in the service to good successe. In 1689 our numbers were 2507."

Governor Trumbull's Report to His Majesty's Secretary of State, dated October, 1774, shows the number on the militia rolls to be 26,260, "all male persons from sixteen years of age to forty-five bear arms, the trained bands in each town attend four days in the year for instructions in military discipline. There are eighteen regiments with a troop of horse to each, and to some two troops; each regiment attends regimental exercise once in four years." In March, 1775, the number of regiments of foot in Connecticut were twenty-two, not including troop of horse, light dragoons, artillery, or independent companies.

In Rhode Island practically the same military organizations existed and in 1640, training days were eight

First American Soldiers—Call "To Arms"

times in a year, and at the second beat of the drum all men allowed and assigned to bear arms were to make their personal appearance completely armed to attend their colors by eight o'clock in the forenoon; also two general masters in each year were provided for in addition. Training days in 1745 were reduced to twice a year, but the two general muster days in each year were continued, and later a review was had of each regiment or battalion twice a year and a general muster and review of each brigade once in two years.

First Confederation of American Fighting Forces was in 1643

The first confederation of the New England Colonies took place as early as 1643, and at a meeting of its commissioners in 1653, who were at that time in session at Boston, after having "considered what number of souldiers might be Requisite, if God called the Collonies to make warr against the Dutch, concluded that five hundred men for the first expedition should bee the number out of the four jurisdictions," and apportioned that number to the several colonies, as follows:

Massachusetts Bay	333
Plymouth	60
Connecticut	65
New Haven	42

and Captain John Leverett of Boston was selected as commander-in-chief of the forces to be so raised.

A few years after this, in 1665, the Connecticut and New Haven Colonies were united under one government, and the Massachusetts Bay and the Plymouth Colonies united in 1692.

The militia in the city of New York in 1678 were formed into companies of one hundred men each, and although but indifferently provided with fire-arms, and those of all sizes and patterns, they were drilled and rendered excellent marksmen by continual practice in firing at a mark. In December, 1772, the governor of the province of New York held a general review in the fields of seven independent companies of the militia formed into a battalion in the following order:

The grenadiers,
Two companies of the Governor's guard,
The rangers,
The Germans,
One of the companies of artillery, and
One company of the light infantry.

The review was witnessed by "a splendid assembly of the principal ladies and gentlemen." After the review the officers were entertained by the governor, who wrote to Lord Dartmouth, stating that "it was the most brilliant militia review that ever was had within His Majesty's American dominions." In June, 1773, the governor of the province of New York forwarded to the home government an abstract of the state of the militia in the province of New York, by which it appears that there were twenty-six regiments of foot and eleven troop of light horse, of which one regiment and one troop were in New York county.

The Pennsylvania militia was organized and trained along the same lines as were the other colonies and in 1775 it was organized into battalions, and on the nineteenth day of August of that year consisted of fifty-three battalions, and in 1776 some of these battalions were composed of eight companies.

George Washington received his early military training in the Virginia militia, and in 1751, at the age of nineteen years, he was appointed adjutant of the militia, and in 1753 he was made commander of the Northern Military District of Virginia, and in 1755 he was commissioned commander-in-chief of all the Virginia militia.

It will thus be seen that the training in arms and the preparation against surprise and attack have been handed down from the days of Captain John Smith and Captain Miles Standish, and that as the settlements increased and the population multiplied the military forces increased in equal ratio, which were under the immediate supervision of the various Colonial General Courts, the Legislature, or the governor of the colony. The company officers, who must be freemen, were elected by the freemen of the

Organization of the Continental Army

trained band to which they belonged; every freeman was compelled to serve in the militia and their names presented to the General Court or Legislature, and if such elections were confirmed commissions were issued by the General Court or Legislature, signed by the governor and under the seal of the colony, and forwarded to the respective officers.

Company drills were held at irregular periods and at such times and places as the commanding officer might designate, and should not be confused with training days or muster days, which were held in the fields and at the times prescribed by the General Court or Legislature. In Massachusetts, the minute-men, which were picked men from the trained bands, during the latter part of 1774 and the early part of 1775, were "disciplined three times a week and oftener as opportunity might offer."

The First Men of the Nation Were Drilled in Use of Arms

Training days, of which there were from two to six during the year, were, in a military sense, the graduating exercises of a finished course of instruction in company drills. Assembly was sounded in some of the colonies at eight o'clock in the forenoon, and on others at one o'clock in the afternoon, when the companies were formed, roll called and the militia exercised in the manual of arms and marching in close order. This was followed by a review and inspection by the colonial officers, then target practice and firing by squads. After this the forces were divided and manœuvred in extended order and finally ended the day by participating in a sham battle. The various state military camps now take the place of the colonial training days.

On muster days every freeman in the colony between the ages prescribed for military duty, except those exempted, was compelled to be present and be inspected, or examined, as to his fitness for military duty and if he passed the necessary qualifications he

was mustered into the militia in his respective district and required to attend company drills and training days.

From these different trained bands there were principally recruited the quota of soldiers which the several colonies were called upon from time to time to furnish in the various wars in which the home government was engaged during the colonial period. The last and most important colonial war, so far as the colonies were concerned, was the French and Indian War, 1754 to 1764, during which the Virginia militia was commanded by George Washington. It might be well to add here that out of twenty-three American major-generals of the Revolutionary War, the majority of them (twelve) had served with distinction as commissioned officers in the French and Indian War, and several of the others as Indian fighters.

Washington's letters during his service in the first Continental Congress held at Philadelphia in September, 1774, show that he was under no delusion as to the outcome of the taxation struggle, and that he expected war, and after its adjournment he was actively engaged in perfecting the militia of Virginia.

The first session of the Massachusetts Provincial Congress was held at Salem on the seventh day of October, 1774, and after being temporarily organized adjourned to the eleventh day of October, 1774, to meet at the courthouse at Concord, and as the improvement of the militia was an object of importance arrangements were made for increasing the quantity of warlike stores and the organization of an army, and at the session held on the tenth day of December, 1774, the several towns and districts in the province were advised to "see that each of the minute-men not already provided therewith should be immediately equipped with an effective firearm, bayonet, pouch, knapsack and thirty rounds of cartridge and balls."

First American Soldiers—Call "To Arms"

On the eighth day of April, 1775, the Provincial Congress of Massachusetts resolved that an army should be raised and established and that other New England colonies should be asked to furnish their quota of men for the general defense.

The records of the committee of safety and supplies show that in accordance with the resolution of October, 1774, authorizing the collection of military stores, that various stores, arms and ammunition were being collected and stored at Concord. To seize those stores Lieutenant Colonel Francis Smith, with a detail of British regulars, consisting of about eight hundred men, embarked from the Boston Common at ten o'clock Tuesday night on the eighteenth day of April, 1775, crossed the Charles river and began the march, which was to bring on the Revolutionary War. He met and dispersed the forewarned minute-men at Lexington at five o'clock on the morning of the nineteenth of April, 1775, and marched on to Concord, destroyed the stores and commenced his return.

"You know the rest in books you have read,
How the British regulars fired and fled,—
How the farmers gave them ball for ball,
From behind each fence and farmyard wall;
Chasing the red coats down the lane,
Then crossing the fields to merge again
Under the trees at the turn of the road,
And only pausing to fire and load."

At length, about sunset, almost on a run the British reached Charlestown Common, where they were sheltered by the guns from the ships. The pursuit stopped and the colonial officers held a consultation. A guard was formed, sentinels posted and detachments were sent out to watch the enemy. The remaining provincial forces consisting of minute-men and trained bands encamped around Boston.

Soon after this the men encamped around Boston were asked by the committee of safety, which was the executive committee of the Provincial Congress of Massachusetts, to enlist until the end of the year, or for a shorter period; also a vigorous circular letter,

dated the twentieth day of April, 1775, was sent to the neighboring towns urging the organization of an army and on the twenty-third day of April, 1775, the Provincial Congress of Massachusetts decided that an army of 30,000 men be immediately raised and that 13,600 be raised from Massachusetts. Committees were sent to the Congress of New Hampshire at Exeter and to the governments of Rhode Island and Connecticut to inform them of those resolutions and urge the furnishing of men in the same proportion.

Minute Men and Trained Bands Were America's First Protectors

So thorough had the work of organization been accomplished in the colonies during the years 1773, 1774 and the early part of 1775 that an appeal for men when the Siege of Boston commenced was immediately successful and a force of from 20,000 to 40,000 men, consisting of minute-men and trained bands, was soon raised. "Throughout the colonies a network of local committees controlling militia companies and post-riders, formed in each colony at the suggestion of the Virginia House of Burgess in March, 1773, watched the approaching storm, tested the loyalty of those who professed to welcome it and guided the popular indignation and when the Battle of Lexington came, the colonies were as well prepared for war as the poor dependencies of a powerful nation could be."

The forces besieging Boston were temporarily under the command of General Artemas Ward, who received his commission from the Provincial Congress of Massachusetts as commander-in-chief on the nineteenth day of May, 1775. A short time prior to this, however, the Provincial Congress of Massachusetts sent a communication to the Continental Congress, then in session at Philadelphia, offering the direction of the forces to that body and suggesting, as had been proposed

Organization of the Continental Army

by General Ward, the organization of an army on the following basis:

1. A General-in-Chief.
2. Troops to be enlisted for the war.
3. Provisions to be made for the support of the families of soldiers.
4. That a loan should be negotiated for the equipment and support of the body, which should be called "The American Continental Army."
5. That the volunteers then in the field before Boston were, as far as practicable, to be re-enlisted, and a special light infantry corps, consisting of six companies of "expert riflemen" from Pennsylvania, Maryland, and Virginia, were also to be enlisted.

On the fourteenth day of June, 1775, a system of rules and articles of war were prescribed by the Continental Congress, which also resolved that six companies of expert riflemen be immediately raised in Pennsylvania, two in Maryland and two in Virginia, to re-enforce the army near Boston. On the following day, June 15, 1775, the Continental Congress announced the selection of George Washington as general and commander-in-chief of the united colonies and of all the forces now raised or to be raised by them.

First Record of an American Continental Army was in 1775

The term, "Continental Army," first officially appears upon the printed records of the Continental Congress in the summary of the proceedings for the fourteenth day of June, 1775, where the form of enlistment to be subscribed by companies of riflemen is given. It was to be an enlistment into the "American Continental Army." On the same day a committee of five was appointed to prepare rules and regulations for the government of this prospective army, which were reported and adopted on the thirtieth day of June, 1775.

For the year 1775 no Continental Army was in the first instance organized as such by the Continental Congress, and as the colonies were mustering their trained bands and minutemen around Boston and Ticonderoga after the Lexington alarm, and as they were already in the field as good material for the nucleus of such an army, the Continental Congress adopted them as the Continental Army, but troops joining later were generally re-

cruited on the Continental basis. After the year 1775 and for the succeeding years of the war, the Continental Congress took the initiative and raised troops for the common army under its own regulations respecting pay, subsistence and term of enlistment. The army, however, as will appear, was organized and reorganized several times during the Revolutionary War, and for various terms. These Continentals were the "regulars" of the Revolution. They formed the main army in the field and were the chief dependence of the revolutionary cause. All other troops raised during the war were either state troops or militia, and were to act as reinforcements of this army, or to relieve it by serving in alarms at different points.

General Washington arrived in camp at Cambridge, Massachusetts, on the third day of July, 1775, and the provincial forces having accepted his leadership and the regulation of the Continental Congress, the entire force consisting of about 14,500 men were placed upon a Continental establishment. This new relation was officially announced by the commander-in-chief in general orders, dated Headquarters, Cambridge, July 4, 1775, as follows: "The Continental Congress having now taken all the Troops of the several Colonies, which have been raised, or which may be hereafter raised, for the support and defence of the Liberties of America into their Pay and Service, they are now the Troops of the United Provinces of North America; and it is to be hoped that all Distinctions of Colonies will be laid aside so that the one and the same spirit may animate the whole, and the only contest be, who will render on this great and trying occasion the most essential Service to the great and common cause in which we are engaged."

After the campaign of 1776 the army was reorganized for 1776. It was not, however, until the reorganization of the Continental Army for

First American Soldiers—Call "To Arms"

1777, that Congress realized that the contest could not be successively carried on with troops enlisted for short terms. The need of a permanent disciplined army to cope with the British "regulars" was recognized as urgent. Congress accordingly, by resolutions of the sixteenth and twentieth days of September, and the eighth day of October, 1776, provided for such a body. The army was proportioned among the states according to their population, as follows:

Massachusetts.....	15	regiments
Virginia.....	15	"
Pennsylvania.....	12	"
New York.....	4	"
Maryland.....	8	"
Connecticut.....	8	"
and the rest in like ratio.		

As a body they formed the Continental Army, and the regiments of each state formed a subdivision by themselves. Each state quota thus became a "Line Regiment" in itself, which was designated by its state's name, as the "New York Line," "Connecticut Line," etc., each being a distinct body commanded by officers from its own state and cared for by its own state as well as by Congress. Inspired by a common cause and welded into a homogeneous body under the leadership of General Washington, it was these state "Lines," facing the enemy as a single "Continental Army" that were to bear the burden of the war for the next six years and bring it to a successful close.

Washington Called for "Clean and Spruce" Men in 1776

The Washington Continental Guard, also known as the "Washington Life Guard," "Captain Gibbs' Guard" and the "Commander-in-Chief's Guard," was organized on the twelfth day of March, 1776, a few days before the termination of the Siege of Boston, pursuant to the following order:

HEADQUARTERS, CAMBRIDGE,
MARCH 11, 1776.

The General is desirous of selecting a particular number of men as a guard for himself and baggage. The colonel, or commanding officer, of each of the established regiments, the artillery and riflemen ex-

cepted, will furnish him four, that the number wanted may be chosen out of them. His Excellency depends upon the colonels for good men, such as they can recommend for their sobriety, honesty and good behavior. He wishes them to be from five feet eight inches to five feet ten inches, handsomely and well made, and as there is nothing, in his eyes, more desirable than cleanliness in a soldier, he desires that particular attention may be made in the choice of such men as are clean and spruce. They are to be at headquarters to-morrow precisely at twelve o'clock noon, when the number wanted will be fixed upon. The General neither wants them with uniforms, nor arms, nor does he desire any man to be sent to him that is not perfectly willing, or desirous of being of this Guard. They should be drilled men."

On the following day, March 12, 1776, Caleb Gibbs of Massachusetts was commissioned captain of the Guard, which consisted of a major's command of one hundred and eighty men, to whom was entrusted the details of the organization.

The Guard, like the Continental Army, was organized and reorganized several times during the Revolutionary War, and on the twenty-second day of April, 1777, the commander-in-chief sent the following letter to Captain Gibbs:

MORRISTOWN, APRIL 22, 1777.

CAPTAIN GIBBS:

DEAR SIR:

I forgot before you left this place to desire you to provide clothing for the men that are to compose my Guard. . . . Provide for four sergeants, four corporals, a drum and fife and fifty rank and file. If blue and buff can be had, I should prefer that uniform, as it is the one I wear myself. I shall get men from five feet nine inches to five feet ten inches for the Guard; for such sized men, therefore, make your clothing. You may get a small round hat, or a cocked hat, as you please. . . .

I am, dear sir, your most obedient
GEORGE WASHINGTON.

In accordance with the foregoing, and on the thirtieth day of April, 1777, the general issued the following circular to the colonels, or commanding officers, of the various regiments stationed at Morristown:

SIRS:

I want to form a company for my Guard. In doing this I wish to be extremely cau-

Organization of the Continental Army

tious, because it is more than probable that in the course of the campaign my baggage, papers and other matters of great public import may be committed to the sole care of these men. This being premised in order to impress you with proper attention in the choice. I have to request that you will immediately furnish me with four men of your regiment; and, as it is my further wish that the company should look well, and be nearly of a size, I desire that none of the men may exceed in stature five feet ten inches nor fall short of five feet nine inches; sober, young, active and well made. When I recommend care in your choice, I would be understood to mean of good character in the regiment, that possesses the pride of appearing clean and soldierlike. I am satisfied that there can be no absolute security for the fidelity of this class of people; but yet I think it most likely to be found in those who have family connections in the country. You will, therefore, send me none but natives, as I do not want to create any individual distinction between them and the foreigners."

The Guard varied in numbers at different periods during the Revolutionary War. At first it consisted of one hundred and eighty men. During the winter of 1779-1780 it was increased to two hundred and fifty men and in the spring of 1780 it was reduced to its original number and in 1783, the last year of the war, it consisted of sixty-four non-commissioned officers and privates. It was the duty of the infantry portion of the Guard to guard the headquarters and insure the safe-keeping of the papers and effects of the commander-in-chief, as well as the safety of his person. The mounted portion accompanied the commander-in-chief on his marches and in reconnoitering, and were also employed as patrols, videttes and bearers of the commander-in-chief's orders to various military posts.

Uniforms of Soldiers of Continental Army in 1776

The Continental Congress on the eighth day of October, 1776, resolved "that for the further encouragement of the non-commissioned officers and soldiers, who shall engage in the service during the war, a suit of clothes be annually given to each of said officers and soldiers, to consist for the present

year of two linen hunting shirts, two pair of overalls, a leathern or woollen waistcoat with sleeves, one pair of breeches, a hat or leather cap, two shirts, two pair of hose and two pair of shoes." On the twenty-fifth day of November, 1779, Congress further resolved, that the following articles be delivered as a suit of clothes for the current and every succeeding year of their service to the officers of the line and staff, entitled by any resolution of Congress to receive the same, viz.: "one hat, one watch coat, one body coat, four vests, one for winter and three for summer; four pair of breeches, two for winter and two for summer; four shirts, six pair of stockings, three pair thereof worsted and three of thread and fo pair of shoes."

On the twenty-third day of March, 1779, Congress by resolution "authorized and directed the commander-in-chief, according to the circumstances of supplies of clothing, to fix and prescribe the uniform, as well as with regard to color and facing, as also as to cut and fashion of the clothes to be worn by the troops of the respective states and regiments—woolen overalls for winter and linen for summer."

In accordance with the above resolution, the following general order, dated Headquarters, Moore House, October 2, 1779, was issued by General Washington. "The following are the uniforms that have been determined for the troops of these states respectively, so soon as the state of the public supplies will permit of their being furnished accordingly; and, in the meantime, it is recommended to the officers to endeavor to accommodate their uniforms to the standard, that when the men come to be supplied, there may be a proper uniformity."

New Hampshire, Massachusetts, Rhode Island and Connecticut:
Blue faced with white,
Buttons and linings white.
New York and New Jersey:
Blue faced with buff,
Buttons and linings white.
Pennsylvania, Delaware and Virginia:
Blue faced with red,
Buttons and linings white.

First American Soldiers—Call "To Arms"

North Carolina, South Carolina and Georgia:

Blue faced with blue,
Button holes edged with narrow white lace or tape,
Buttons and linings white.

Artillery and Artillery Artificers:

Blue faced with scarlet,
Scarlet linings,
Yellow buttons,
Yellow bound hats,
Coats edged with narrow lace or tape and button holes bound with same.

Light Dragoons:

The whole blue,
Faced with white,
White buttons and linings.

HEADQUARTERS, SHORT HILLS,
JUNE 18, 1780.

The colonels, lieutenant-colonels and majors, the uniforms of their regiments and two epaulettes.

The captains, the uniform of their regiment and an epaulette on the left shoulder. All officers as will warrant, as commis-

sioned, to wear a cockade and side arms, a sword or a genteel bayonet."

HEADQUARTERS, NEWBURGH,
MAY 14, 1782.

"The clothier is, if practicable, to obtain worsted shoulder knots for the non-commissioned, to wear a cockade and side arms, distinguished by one on each shoulder and the corporals by one on the right shoulder, and in the meantime it is proposed that a piece of white cloth should be substituted by way of distinction."

The military record of the New World, while not as spectacular as that of the Old World, is a story of strong men with strong hearts who have conquered strong forces until today this first struggling republic is one of the strongest nations of the earth and stands at this moment a world power—learned in the arts of peace and the forerunner of an age of Universal Brotherhood.

WHEN SORROW BECKONS AT THY DOOR

BY

HOWARD ARNOLD WALTER

Shall I rejoice that thou hast never known

Life's thorny, bitter way;

That woodland glades with roses overblown

Are where thy glad feet stray?

Aye,—tho' I toil alone

Beneath my cross this day.

Shall I recall thee from thy roses, sweet,

To feel the thorns with me;

When deathless sorrow hath not lured thy feet

Nor taught thine eyes to see?

Nay,—'twere not meet

My grief should sadden thee.

But O, when sorrow beckons at thy door,

And thou dost rise and follow far,

As I rejoin thee on the distant shore

Where all earth's grieved ones are,

If thou implore

I'll show my livid scar.

Country Life in America



**PATH THRO' THE WOOD
DRAWING BY DANIEL F. WENTWORTH**



MOONLIGHT
DRAWING
BY
DANIEL F. WENTWORTH



THE ROAD HOME

SUN GRAVURE

BY

GEORGE C. ATWELL



THE OLD MILL

SUN GRAVURE.

BY

GEORGE C. ATWELL



THE MEADOWS

DRAWING

BY

DANIEL F. WENTWORTH



THE BROOK
SUN GRAVURE
BY GEORGE C. ATWELL

The Academy of American Immortals

AMERICANS are united in a resolute purpose—the erection of a Great Edifice of Human Equality on the Western Continent. It is the structure, not the architects nor the builders, that is uppermost in the American mind.

With this monumental labor slowly but steadily moulding itself into the greatest tabernacle of "Life, Liberty and the Pursuit of Happiness" that human mind and heart and hand have ever conceived, the artisans are beginning to recognize that there is he among them who has contributed largely.

It matters little whether it be under the Empire or the Republic, in the short Day's Work of Man there will always be One whose craftsmanship and ingenuity will lift him up from the ranks.

American spirit knows nothing of idolatry. It is not hero-worshipping. It loves Honest Work, well done, and, when it beholds it, grasps the hand of the Worker—and the pulse throbs in manly recognition and brotherly affection.

The Heart of Man is great. It is greater even than his marvelous intellect and his determinate brawn. This recognition of the fellow-worker's skill is one of the noblest attributes of Man. No community of people—no nation—can become permanently strong that does not recognize the individual achievements of its workers.

Westminster Abbey is an incentive for every toiler under the British

Flag to do his Day's Work to the best of his ability—its portals are thrown wide and willingly open to him whose completed work is done a little better than that of the other laborers. France has its Academy of Immortals—its Pantheon in Paris, and Germany its "Ruhmes Halle."

It is the American people who have dedicated "The Hall of Fame" for their great kinsmen whose services have contributed liberally to the Great Whole.

This magnificent tribute to American Achievement stands on the bank of the Hudson, commanding a sweeping view of the Palisades, the historic heights of Fort Washington where one of the hardest struggles for American independence was fought, and at the gate-way of the New World.

A senate of one hundred eminent Americans confers the honor on the Americans whose labors entitle them to the immortal memory of the American people.

The first American chosen to the "Hall of Fame" was George Washington, who received the full recognition of the electorate in which ninety-seven members conferred, three being absent.

The second American elected was Abraham Lincoln, with ninety-six; Daniel Webster, third, with ninety-six; and Benjamin Franklin, fourth, with ninety-four.

Forty Great Americans are now immortalized in the "Hall of Fame." A series of bronzes to their memory is appropriately inaugurated in these pages.

THE HALL OF FAME

FOR GREAT AMERICANS

BY WEALTH OF THOUGHT

OR, ELSE BY MIGHTY DEED

THEY SERVED MANKIND

IN NOBLE CHARACTER

IN WORLD-WIDE GOOD

THEY LIVE FOREVERMORE



FIRST PRESIDENT OF AMERICAN REPUBLIC

GEORGE WASHINGTON

BORN AT BRIDGES CREEK, VIRGINIA, FEBRUARY 22, O. S. 11, 1732
DIED AT MOUNT VERNON, VIRGINIA, DECEMBER 14, 1799



FIRST GREAT AMERICAN LIBERATOR

ABRAHAM LINCOLN

BORN IN HARDIN COUNTY, KENTUCKY, FEBRUARY 12, 1809
DIED AT WASHINGTON, DISTRICT OF COLUMBIA, APRIL 15, 1865



FIRST GREAT AMERICAN STATESMAN

DANIEL WEBSTER

BORN AT SALISBURY, NEW HAMPSHIRE, JANUARY 18, 1783
DIED AT MARSHFIELD, MASSACHUSETTS, OCTOBER 22, 1852

THE GREAT AMERICAN STATESMAN
OCTOBER 22, 1852



FIRST GREAT AMERICAN DIPLOMAT

BENJAMIN FRANKLIN

BORN AT BOSTON, MASSACHUSETTS, JANUARY 17, 1706
DIED AT PHILADELPHIA, PENNSYLVANIA, APRIL 17, 1790

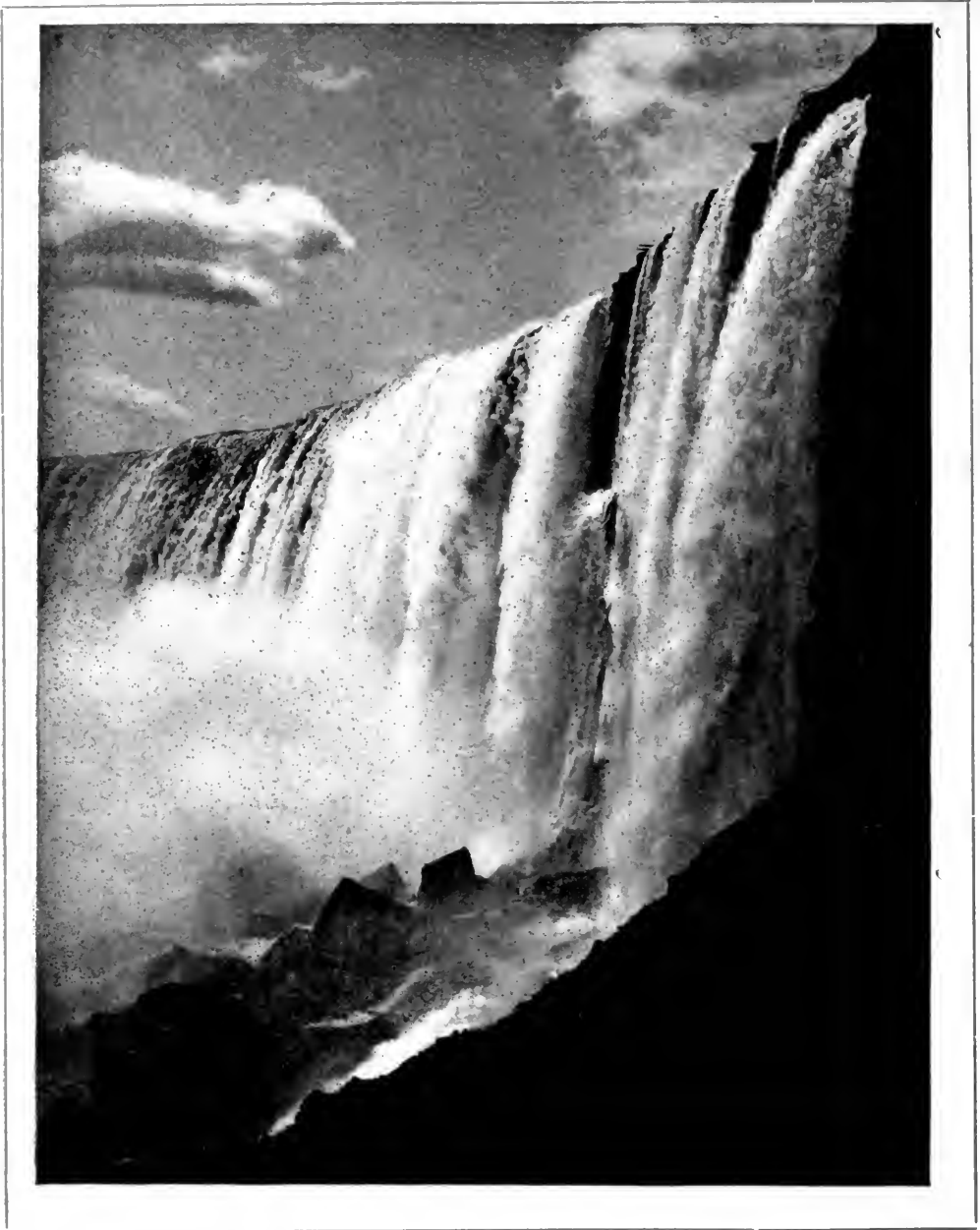

"MONARCH SUPREME IN NATURE'S GLORIOUS REALM"

But few American poets have sung the praises of Niagara. For nearly half a century this marvelous pageant has been neglected in literature. About 1825, John J. C. Brainard, while residing in Hartford, wrote a poem, "Niagara," which according to the critics of those days "produced a sensation of delight over the whole country." That American Poetry is not dead is proved by the stirring lines to Niagara here written by a venerable American lawyer, who is about to pass through the gateway of the octogenarian, with the vigor and patriotic spirit of the generation which he still represents. Henry Taylor Blake, the author of this new ode, was born in 1828 at New Haven, Connecticut. He was graduated from Yale in 1848; studied law and was admitted to the bar of Hartford county in 1851, retiring from active practice in 1888

Contemporary American Poetry

An Ode to Niagara Falls

BY

HONORABLE HENRY TAYLOR BLAKE

NOW IN HIS SEVENTY-NINTH YEAR

LIKE him of Patmos who in vision rapt
Beheld in Heaven Jehovah's great white
 throne
And speechless worshipped, thus with
 reverent awe
Before thy royal state I bow, Niagara!
Monarch supreme in Nature's glorious
 realms

Of Beauty, Grandeur, Majesty and Power!
Monarch and psalmist both! whose mighty harp
Like that of Israel's King, with vibrant strings
Repeats in chant sublime thy Maker's name.
Fit music for this wondrous amphitheater
Whose pageants God's own hand has framed and moves
Incessant through the years in pomp divine!
Draped from the wide arena's farther wall,
Yon streaming curtain shows in living scene
A sliding, shimmering precipice of foam
Half veiled in rolling clouds of bursting spray,
Whose gullied front with changing hues aglow
And glimpsed in gleams of fitful splendor, seems
An endless avalanche of emerald and snow;
Or like a marble mountain's beetling cliff,
Its tumbling crags in dusty ruin hurled;
While like a dirge in varying cadence floats
Across the misty gulf, their deep despairing roar.
Turning I downward peer with shuddering gaze
Over the plunging cataract's dizzy verge,
Stunned by the throbbing thunder-roll below,
Where Hell's infuriate cauldron boils and spouts
And quivers with the throes of bellowing floods
In that fierce torture-dungeon pent and torn!
Their writhing ghosts, out from the vortex flung
Bewildered whirl; then some in somber train
Like spirits lost, flit weeping: some with joyous flight
Swift through the golden archway overspread
Like radiant portal of immortal hope
Upsoaring, vanish at the gate of heaven.

FAR up the stream in restless flashing line
Thy heaving waters meet the horizon's
 edge.
Lo! leaping from the sky in pauseless
 flow
Unnumbered billowy legions, rank on
 rank

In plumed array sweep down the tossing slope!
Onward they drive in eager, mad career!
They hear thy battle thundering at the front!
They see thy banner glittering o'er the fray,
And shout exulting! but the foremost lines
When thy deep dread abyss yawns wide below
Shrink back appalled, recoiling from their fate!
Vain thought! borne onward in impetuous course
Their loose battalions massed for final charge
Are headlong hurled to join the dreadful war
Where crashing its volleys on the mail clad rocks
Thy fierce artillery smokes in ceaseless peal!
Stupendous strife of Nature's mightiest powers!
Resistless Force with Strength immovable!
But thine all shattering blows break piecemeal down
Those armored hosts and beat them into dust
And bear them backward in a murky tide;
First, slow and sullen, then in frantic rout
And desperate race, pursuers and pursued
In wild commingling piled, with deafening roar
Down through that gloomy gorge where thou hast
 fought

Thy tireless battle of ten thousand years
Moving thy standard onward, inch by inch!
Slowly the turmoil dies; the struggle ends;
O'erwhelmed the vanquished sink, and the victorious
 hosts
With trampling rush above their fallen foes
Press on to reach the goal by glory won,
Death's and Oblivion's dank and turbid pool!



"FAR UP THE STREAM IN RESTLESS FLASHING LINE"—NIAGARA RIVER

AND now the setting sun's departing beams
Light up thy face with warm responsive
glow
As if thou answeredst back his kind
"Good Night!"
And thus with fond attention hour by
hour

Thy brow reflects his every changing mood;
Bright when he smiles, and shadowed when he frowns,
But all things else thou heedest not, withdrawn
In solemn mystery apart, inscrutable;
Speaking thy thunders to no earthly ear,
And tossing man or beast or floating log
Indifferent which, and all with equal scorn!
For he, thy sire, who warmed thee into life
Smiled the first welcome to thine infant form
When the great glacier mother gave thee birth
And scooped thy cradle in the solid rock,
Then dying, left thee to his fostering care.
And he and thou in lone companionship

Through æons vast together have beheld
The myriad changes of Creation's growth;
Seas, lakes and rivers, mountains, hills and plains,
Deserts and forests, reptiles and monsters strange,
Fierce beasts and fiercer men, race slaughtering race,
In long succession come and pass away;
Thyself and he, the only deathless things!
And still his radiant orb undimmed shall light
Unnumbered generations to adore
At thine all-glorious shrine, all glorious still
Though marred by fripperies, and despoiled by greed,
While empires wax and wane and disappear.
Till Time's tired footsteps drag but feebly on
And Earth decrepit staggers to her end!
Then shall his face grow wan with age and cold
And thy swift rushing torrents freeze to stone;
And slowly mantling in the gloomy pall
Of Nature's icy death-bed, thou and he
Shall sleep together in eternal night.



"OVER THE PLUNGING CATARACT'S DIZZY VERGE"—NIAGARA FALLS



"NATURE'S ICY DEATH-BED"—NIAGARA FALLS IN WINTER



THE FIRST AMERICAN'S GREETING TO THE WHITE MAN
By Herman Atkins MacNeil, Sculptor

HERE LET ME DWELL

BY

REVEREND FREDERICK E. SNOW

I LOOKED across the valley from my home
When Winter's frosty hand held in its grip
The wide and barren landscape; here and there
Patches of evergreen stood forth distinct
And vivid mid the all-pervading gray
Of sky o'er-head and circling atmosphere.
A storm had raged through all the day and night,
And every tree trunk had its snowy coat;
The woods looked like a group of spectres wan
And with uplifted arms in mute appeal
To Heaven to pity them, bereft and stripped
Of all of Summer's beauty. A leaden sky
Still hung above the white and snow-bound earth;
Pale shadows lay along the lines of fence;
The houses rose from out their muffled yards
Like ships from out the foam of troubled seas;
Deep in the valley, outlined by the trees
Which sparsely stood along its frozen brim.
The brook was babbling 'neath its mail of ice;
The village looked so like a little world
Half buried, yet rising from its fleecy tomb.

'Bove every roof the smoke curled hesitant,
Reluctant thus to leave the sheltering warmth
Of wide and generous chimneys. Signs of life
Were here and there visible; and forms dark
Against the universal white moved, now
From house to barn, from barn to well,
Tracing the curious labyrinth of paths,
Through which, as through a loom the shuttle moves,
The children chased each other back and forth.
Half way up the hill, facing the long street
Stretching southward, stood like a sentinel
The village church, guarding with jealous eye
Her trusting children as they worked or slept.

HERE LET ME DWELL

A little world shut in and by itself;
A world behind its snowy ramparts hid,
Having its own sorrows, its own tears;
And yet a world "far from the madding crowd,"
Unvexed by mad ambition, eager strife,
Competition in which one must go down
To cruel disappointment's black abyss;
A world where love delights in ministry
In common things, nor vaunts itself before
The eyes of men, as tho' it sought applause;
A world where each his neighbor gladly serves
And counts it scorn to think of recompense;
A little world lying beneath God's eye
Content within the circle of His love!

Let those who will dwell midst the noisy din,
The harsh clamor, of the world's contention,—
Ceaseless debate of questions without end,
And strife for earthly dignity and rank,—
The heedless scramble after tinsel toys,
The heated chase for riches' gilded prize;
Give me a book before the fireside
Where the soft nestle of the murmuring flame
Stirs tender tho't, and soothes the tangled brain;
Where, from the circle of the village life
Some friend congenial and with like taste
Shall come, tho' all unbidden, yet to find
His chair set forth, and welcome waiting him;
Where quiet talk shall glide from lip to lip,
Or if perchance the flow of words shall cease,
Unspoken tho't shall tell of sympathy,
And silence shall be full of golden speech!
Here let me dwell in calm serenity,
Secure from hard, insistent claim,
From every brazen, insolent demand
To render homage where desert is not,
To worship at a shrine whence worth has fled—
I'll be content and thank a gracious God
Who lets the lines of life fall happily!

Letters of a Sergeant in War of 1812

Romance of John Burt, First Battalion Artillery, and
Persis Meacham—With Transcripts from Correspondence

BY

WILLIAM BURT HARLOW, PH.D.

GRANDSON OF SERGEANT BURT

AMONG the ancient papers left by my grandmother I find a bundle of old letters and from them I gather glimpses of a real old-time courtship—a romance such as our grandmothers and grandfathers experienced when the American Republic was in the making. There is a gentility and a gallantry to these worn documents that flavors of the Old World. In the changes of time these courtly manners have gone with those whom they graced and it is indeed pleasurable to look upon the lines of those who lived "when knight-hood was in flower."

It was one hundred and twenty years ago that my good grandmother was born on Enfield street in northern Connecticut. Her name bears the imprint of days long gone—"Persis"—quaint Persis Meacham.

Her father's little farm was one of several estates that were united to form the property of that successful founder of the mills from whom Thompsonville, Connecticut, is named. My grandmother remembered "that little Thompson boy" as a ragged barefoot urchin running about the lots in old Enfield. Only the wells of the former farms were allowed to remain to tell the tale of the old days and the great mansion standing in its commanding position in the midst of a fine grove is still seen next the quaint old church with its slender spire. Here Persis Meacham attended service until she was thirty years old and the old building remains much as it appeared then ninety years ago. The wooden bridge from Enfield across the Connecticut river to Suf-

field was a few years ago carried away in a spring flood. It was shaky and called unsafe when I rode over it ten years ago. My grandmother used to walk over it daily on her way to the Suffield school of which she was mistress.

John Burt of Longmeadow was courting her in those days and as he was the son of a Revolutionary officer, Colonel Gideon Burt, he naturally felt called upon to follow in the footsteps of his sire who procured him a commission as sergeant to serve in the War of 1812 at Sackett's Harbor and Fort Michilimackinac. His term was for five years and the youthful lover, who was six years the junior of his lady-love, must cease his visits at the Enfield farm and shouldering a musket depart with his regiment into the wilderness.

Letters were slow in coming in those days and the postage amounted to eighteen cents. I fear my grandpapa was rather neglectful of his poor little Persis. She may perhaps be excused for lecturing him a little, for he was twenty-two and she was twenty-eight. She was old enough to know what was what and I am glad she gave him a piece of her mind. I will copy one of her letters which is interesting when compared with what might be written by a girl to her sweetheart at the present day.

ENFIELD, FEBRUARY 3, 1816.

MY DEAR FRIEND:

I received your letter yesterday with much pleasure as well as surprise, for I had long since supposed myself forgotten by you. I am happy to hear that I am still remembered by you & that I still retain the same friendship and affection for you as ever. I think you have been rather too neglectful in writing to me; you have

Letters of a Sergeant in War of 1812

wrote to your other friends much oftener than to me. Almost three years have elapsed since you left Enfield and I have received only four letters from you and this is the eighth I have addressed to you in your absence. However, I am willing to make every allowance for your omission in writing if you will be more punctual for the future, altho' I am unacquainted with a military life I know there must be many inconveniences. I rejoice to hear of your good health & agreeable situation, may it still continue, may you receive every blessing that is necessary to make life agreeable. Your father received your letter on Thanksgiving day; it gave your friends much joy, I was then at Long meadow and had an opportunity of perusing it through the kindness of Gideon which gave me much pleasure as you expressed your love for those that loved you only, and I thought I might be one of that number. Oh, John! have you got to stay more than two years longer? Three years are almost past which seems like a little eternity. Alas! must you stay your five years? Write I entreat you and let me know if there is a probability of your return before that period which I live in constant hope there is. Thanksgiving eve I attended Wm. Stebbins and Eliza B's. wedding. Happy, happy union! two fond hearts are joined in one. Your brother has once more received a wound from little Cupid but I think there is a remedy before winter is out I think he will be firmly bound in Hymeneal bonds with Miss Sally Kibbe; he seems to think of nothing else at present but his approaching nuptials. Write me as often as possible and be assured I shall not omit the same. Adieu my friend, I still remain your

PERSIS.

The reply of the soldier lover written in good round hand is dated more than seven months later, but then it took more than four months for his lady-love's letter to reach him. One had need of much patience in those days of uncertain mail transportation.

MICHILIMACKINAC
14th Sept. 1816.

MY DEAR PERSIS:

Your kindly letter I received on the 16th of June last which I would have answered long since but no opportunity offering from the inconvenience of vessels from Detroit not arriving as I should wish to convey it. I am happy to inform you that I am well at present, although afflicted with the fever and ague for some time past which I hope these few lines will find you in good health also. My feelings are rather hurt at find-

ing that you should imagine or even think that you were forgotten by me on account of not punctually writing to you. No, my Dear Persis, it is the fate of a soldier's life to be thus disappointed in the sanguine expectation of doing an act of the most important concern to be turned from it in a moment, but those in private life have no Idea of such inconvenience,—I know my Dear, the time is long since my departure from Enfield, but what can I do? here I am bound and cannot stir without bringing disgrace upon myself and family until regularly and legally released from such embarrassment; if then this should be removed I must say you would have enough of room to impeach me with neglect but I shall be as punctual in Writing for the future as the nature of this place will admit—I am obliged to you my Dear for your good Wishes for my being in good health which is more precious than all other riches, and equally so for you being in the same state; but as to my Situation although as agreeable as the nature of it will admit is not to me so, particularly being so long apart from you and my other relations and friends but I hope my Father will shortly effect something for my Relief.

I am glad to hear of the happy Union of Mr. Wm. Stebbins and his Consort and wish them all happiness, not but I regret the distant period of ours which I hope will some time or other take place. I shall write you every opportunity and hope you won't neglect answering as it will be the only consolation I shall have in my present situation. The Indians here are quite peaceable at present. Remember my love to all friends and remains your ever affectionate and unalterable

JOHN BURT
Sergeant Artillery
Capt. Pierce's Company, 1st Battalion.

John Burt, it appears, did not get a commutation of his term of service, but at the end of the five years patience had its reward and the lovers were united in marriage or I should not be telling their story.

Then came the long journey by stage from Enfield out into the great wilderness of Ohio. They settled in Euclid, now known as a beautiful suburb of Cleveland.

I have before me the list of the household outfit purchased on their arrival in 1818, amounting to \$72.82½ and paid for by Colonel Gideon Burt, their father. Among the forty-two articles are the following:

John Burt, First Battalion Artillery

1	pair linen sheats, 30s	\$ 2.50
1	pair pillow cases,	1.00
5	old table spreads, 15s	1.87½
3	flannel sheats, 15 yds. 6s	11.25
4	old towels, 6s75
1	carving knife and fork,	1.00
1	snuffer tray,50
1	patchwork bedquilt,	2.00
2	small flannel gowns,50
3	pairs mits,50
2	pairs socks,50
1	pair stocking legs,25
3	pieces cotton factory,37½
1	small red slip,37½
1	pair drawers,50
1	chest,	2.00
1	tea canister,50
1	pair buckskin gloves,	1.50
8	phials,50
15	nutmegs,	1.20

Nutmegs were costly in those days, at eight cents apiece, and were probably much more indispensable than now as they were largely used, not only for flavoring foods, but drinks.

My mother was the first of three children and born in the town of Euclid. The father, who was a joiner, found plenty of work in the new country. When he was not building houses and barns he was making cradles and coffins. He was easy-going and kind, never demanding what was owed to him, and debts were not always voluntarily paid. After spending about ten years in the new home the father heard of the need of men to build the ship canal in the southern part of the state, and, tempted by the high wages paid, he moved his family to Chillicothe, Ohio. It was a sadly unfortunate venture. The country was swampy and malarial. John Burt, who was at the head of a gang of men, must be a leader, and as the others were often afraid to venture into the water to work he would precede them to show that there was no danger. He must thus stand in water for many hours and return home at night with wet clothes. My mother, who was about nine years old, was attacked by the malarial fever and her devoted father, after his exhausting work, sat up with her during the night. What wonder that the soldier's constitution, though strong, gave away under the strain! The child recovered, but the brave and faithful father fell a prey to the fever that carried off so many of the early settlers and died at the

age of thirty-nine, leaving a frail widow and three small children.

Poor Persis was in a land of strangers and her first thoughts were to return to Euclid where there were warm hearts to welcome her. There were weary miles of stage travel and her oldest child, hardly recovered, was so thin that her little frail hands held up to the light showed all the bones; her hair had fallen out and she wore a little cap to cover her bald head. She was so sick from the jolting of the stage that she was lifted out helpless at the way stations.

At Euclid the mother thought it best to return to the east against the advice of several good friends. She wrote to her husband's brother for assistance. He was a well-to-do man and childless. He owned a controlling interest in the stage route between Albany and Boston, in those days bringing in large revenue.

The letter which he wrote to Persis I must transcribe to show a phase of human character. It has always seemed heartless in its tone, but he proved a good friend at last and adopted the younger daughter; also aided the rest of the little family.

WORCESTER, DEC. 29, 1830.

DEAR SISTER AND STRANGER:

Your letter is recd. giving me the desired situation that you are in and your children and imploring some relief. The widow and fatherless are objects of charity from all and in particular from those that are connected by blood or by marriage. You are a stranger to me otherwise than by your connection with a Brother who I have not seen but once in twenty years. His misfortunes and troubles I have been unacquainted with. With regard to assisting you I have concluded to send you fifty dollars that may be present help if you conclude to stay in Euclid or if you should conclude to leave and come to N. England it will be sufficient amount to bring you here. Whatever should be your determination I would say that one of your children, the youngest, if you can make up your mind to give it away to us as we have none of our own, we have concluded to take it. The other two I shall, if they come here use my influence to procure them a home. Brother Nathaniel will perhaps take one of them, but a home shall be provided for

Letters of a Sergeant in War of 1812



QUAINT SILHOUETTES OF A BRIDAL COUPLE IN EARLY YEARS OF LAST CENTURY
Persis Meacham, born in 1785
Sergeant John Burt, born in 1791

all until such times as you may be able to provide for yourself.

Poverty you claim and if you should undertake the journey you will remember that at this season of the year it is cold and more expensive traveling. I should recommend to you to dispose of all but what is necessary for your comfort and to make your children and yourself warm, and that you should make some exertions to travel as cheap as possible. There is no other way but to come all the way in the stage. If by misfortune you should fall short of cash when you arrive at Albany call at the stage office of Rice and Baker and inform them who you are and tell them I will see that they are paid and show them the postscript.

Yo. SIMEON BURT.

And so the forlorn little family, unable to collect the many sums due to the poor father, accepted the cold invitation and took the weary journey which in those days must have been an undertaking equal to that of crossing the continent at the present time.

The Connecticut home of Persis had been broken up. Her father and mother had long since died and the brothers and sisters had married and scattered. The two little daughters of Persis were for a time sent to the Enfield High School by the benevolent uncle. The younger, who had been

adopted by him, continued her education, but the elder, who had a longing for education, was given but one year of this, to her, happy school life when she was required, at the age of sixteen, to learn a trade and take care of herself and her mother. The one boy, Simeon, was of a roving disposition and gave his mother much anxiety. He could not be kept steadily at any occupation. He finally ran away while yet in his teens and enlisted on board a man-of-war. It was a mistaken kindness on the part of the little mother to go down to New York and beg him off, for he was afterwards of little comfort to her and finally joined a tribe of wandering Indians, returning with them to Maine where he married among them and died without issue and with no communication with his sisters who had married well and lived in New York and elsewhere in the growing nation.

The little mother, Persis, spent her last days in Worcester, Massachusetts, with her elder daughter who had also become a widow, and died among kind friends at the age of sixty-one years.

First Champion of Universal Peace

**Memoirs and
Anecdotes of Elihu Burritt, an
American Farmer-lad who rose from a Blacksmith's
Forge and through Self-instruction Acquired the Tongues of
Fifty Nations & He Appealed to Christendom to Cease Warfare
and Became Honored by the Master Minds of the Old World & Reminiscences**

BY

HONORABLE DAVID NELSON CAMP, M.A.

STATISTICIAN IN DEPARTMENT OF EDUCATION AT WASHINGTON IN 1867—MEMBER OF FACULTY AT ST. JOHN'S COLLEGE IN MARYLAND IN 1866—SECRETARY OF NATIONAL TEACHERS' ASSOCIATION IN 1864—MAYOR OF NEW BRITAIN, CONNECTICUT, THE HOME OF ELIHU BURRITT, IN 1877—NOW AN ACTIVE EDUCATOR IN HIS EIGHTY-SIXTH YEAR

It has been estimated that since the beginning of authentic history war has destroyed fifteen billions of human lives. I have seen the estimate put at twice that number. The estimated loss of life by war in the past century is fourteen millions. Napoleon's campaigns of twenty years cost Europe six millions of lives.

The Crimean War.....1854.....	750,000				
The Italian War.....1859.....	63,000				
Our Civil War, North and South..... (killed and died in other ways)	1,000,000				
The Prussian-Austrian War.....1866.....	45,000				
The expeditions to Mexico, China, Morocco, etc.....	65,000				
The Franco-German War.....1870.....	250,000				
The Russo-Turkish War.....1877.....	225,000				
The Zulu and Afghan Wars.....1879.....	40,000				
The Chinese-Japanese War.....1894.....	10,000				
The Spanish-American War.....	5,000				
The Philippine War.....1899.....	<table border="0"> <tr> <td> } Americans</td> <td>5,000</td> </tr> <tr> <td> } Filipinos..</td> <td>1,000,000</td> </tr> </table>	} Americans	5,000	} Filipinos..	1,000,000
} Americans	5,000				
} Filipinos..	1,000,000				
The Boer War..... (killed and wounded)	<table border="0"> <tr> <td> } British....</td> <td>100,000</td> </tr> <tr> <td> } Boers.....</td> <td>25,000</td> </tr> </table>	} British....	100,000	} Boers.....	25,000
} British....	100,000				
} Boers.....	25,000				
The Russo-Japanese War.....	450,500				

These are probably all under the actual facts.

BENJAMIN F. TRUEBLOOD,
Secretary American Peace Society.

IN conflicts within the lifetime of men who are now living, more than three billions sterling have been thrown into the cannon's mouth and nearly a million fellowmen have fallen martyrs to the battlefield.

In the United States of America, a government founded on the brotherhood of man, the greatest expenditure since the beginning of the Republic in 1789 has been for bloodshed—over six billions for war, nearly two billions for navy, and about three and one-half billions for pensions—more than eleven billions out of a total of something over nineteen billions of dollars.

Since 1850 the population of the

world has doubled: its indebtedness, chiefly for war purposes, has quadrupled. It was eight billions fifty years ago, it is thirty-two billions to-day.

This is the dawn of the Age of Humanism when the peoples of the civilized earth will lay down the weapons of brutality and arbitrate their differences through the Power of Moral Intelligence. The eighteenth of May of this year has been appointed as Peace Day in many of the States of the American Union and countries of Europe. The second Hague Tribunal also convenes this year and it is indeed a propitious time to turn attention to the First Champion of Universal Peace—Elihu Burritt, an American whose memory has too long remained unhonored.

Recollections of Elihu Burritt

TO recall my memories of Elihu Burritt—that strong man in American history who began at the blacksmith's forge and became a world-renowned linguist and advocate of universal peace—is indeed a pleasure, and especially so if I can throw any new historical light on this distinguished figure.

Elihu Burritt was the world's first champion of universal peace. It was this distinguished American who appealed to the nations to lay down arms and to apply reason rather than physical force to their misunderstandings. He was as well-known in Europe as in America, for a good part of his lifetime was spent in philanthropic enterprise which had England and the United States for its field, and his books have been as popular on the eastern hemisphere as on the western continent.

Burritt's career has been unique in America. He is not the only philanthropist or self-made man that we have produced, but he is the only one who has achieved for himself and by himself such a wide acquaintance with foreign literature, and at the same time, given his active life to the amelioration of the condition of his fellow-men throughout the earth.

The service requested of me is to give my reminiscences of the great Burritt, who for some years was my fellow-townsmen and friend. All that I record, however, cannot be personal recollections. For periods of his life during which I saw nothing of him I depend upon other records to which I here acknowledge my indebtedness.

There is a maxim: "the boy is father to the man." If I had known the boy Burritt I might have been able to have shown the embryo characteristics that developed into the man Burritt, but unfortunately for me, and possibly fortunately for him, he was ten years old before I was born, and while our birthplaces were not many miles apart

it was in the era before transportation facilities, when a neighboring town was almost as foreign as a neighboring country.

Elihu Burritt was born in New Britain, Connecticut, December 8, 1810; and ten years later, or in October, 1820, I was born in Durham, and it was not until manhood that I made Burritt's acquaintance. I presume the boyhoods were very much alike in the two Connecticut villages. It was an age of barefooted summers and tipped winters. There was the old "swimmin'-hole," the little red schoolhouse and the sanctified "meetin'-house." It was a time when the community lived faithfully by the maxim: "Early to bed, early to rise, makes a man healthy, wealthy and wise."

Burritt, then, was much the same boy as the rest of us. He was the product of a long line of rugged ancestry—a descendant of William Burritt who came to this country from the south of Wales and settled in Stratford, Connecticut. His father and grandfather were both named Elihu and were respected in the community in which they resided. His father had his home in New Britain, working on a farm in summer and at the shoemaker's trade in winter. According to the custom of the day he had a large family and he sometimes found it difficult to supply the needs of the family by his scanty earnings.

Elihu Burritt was the youngest son of ten children and in his childhood was deprived of many things which were esteemed the necessaries of life. He told it of himself that when he went to the district school he was not furnished with a single book and he learned his lessons from books borrowed and from listening to the recitations of other children. As he could have a book only when not needed by its owner he had to apply himself with diligence while he had the book. In later life he said that he attributed his habits of intense application and close observation partially to the circumstances of his earlier experience and

First Champion of Universal Peace

the necessity of making the best use of the few helps he had.

Soon after he was sixteen years of age and on the death of his father he felt the need of earning something for the family as well as for his own personal needs. He was apprenticed to a blacksmith and at once applied himself diligently to learning the trade. The days in the shop were long and he worked early and late, but he made frequent calls on his mother who was a woman of strong powers of mind. She encouraged Elihu in his efforts to fit himself for usefulness. He was a great reader and he read all the historical and biographical books in the village library, which was well provided with volumes of this class. When partly through his apprenticeship he commenced the study of Latin.

At this time his chief aim and desire was to become an accurate surveyor. As evidence that he possessed more than ordinary talent in this direction it may be stated that he mentally solved two following problems—and unaided by pencil, chalk or anything of the kind, actually working them in his mind while working at the anvil:

1. How many barley-corns, three to an inch, will it take to extend around the earth at the equator?

2. How many yards of cloth, a yard wide, allowing half an inch at each end for lapping, would it require to reach from the center of the sun to the center of the earth, and what would it all cost at one shilling per yard?

It will readily be admitted that any one who could mentally obtain the correct answers of these questions as Burrirt did must be possessed of more than ordinary mathematical ability.

I here give the contents of a personal letter which he wrote to William Lincoln of Worcester, Massachusetts, in 1838. In this letter he says:

"At the expiration of a little more than half of my apprenticeship, I suddenly conceived the idea of studying Latin. Through the assistance of an elder brother, I completed my Virgil during the evenings of one winter. After some time devoted to Cicero and a few other Latin authors, I commenced the Greek. At this time,

it was necessary that I should devote every hour of daylight, and a part of the evening, to the duties of my apprenticeship. I carried my Greek grammar in my hat, and often found a moment, when I was heating some large iron, when I could place my book open before me, and go through with 'tupe, tupters, tupter,' unperceived by my fellow apprentices, and, to my confusion of face, sometimes with a detrimental effect to the charge in my fire. At evening, I sat down unassisted and alone, to the Iliad of Homer, twenty books of which measured my progress in that language during the evenings of another winter.

I next turned to the modern languages, and was much gratified to learn that my knowledge of Latin furnished me with a key to the literature of most of the languages of Europe. This circumstance gave a new impulse to the desire of acquainting myself with the philosophy, derivation, and affinity of the different European tongues. . . . I therefore laid down my hammer, and went to New Haven, where I resorted to native teachers in French, Spanish, German and Italian.

At the expiration of two years, I returned to the forge, bringing with me such books in those languages as I could procure. When I had read these books through, I commenced the Hebrew, with an awakened desire for examining another field; and by assiduous application, I was enabled, in a few weeks, to read this language with such facility, that I allotted it to myself, as a task, to read two chapters in the Hebrew Bible before breakfast, this, and an hour at noon, being all the time that I could devote to myself during the day.

After becoming somewhat familiar with the Hebrew, I looked around me for the means of initiating myself into the fields of Oriental literature, and to my deep regret and concern, I found my progress in this direction hedged up by the want of requisite books."

In my prolonged years as an educator it has been my good fortune to make the acquaintance of many bright men and women, but there has been but one Elihu Burrirt. For studious concentration, I doubt if his equal has ever been known in an American university. With the exception of the two years in New Haven, where he had the aid of instructors in acquiring a few of the modern languages, he had no opportunity of aid at school, or from teachers, except three months at his brother's private school when he was twenty-one. He attended the district school somewhat irregularly until he was fifteen, but his acquisition of foreign languages was made after he left school.

At the end of his school term he resumed his work at the anvil where he resolved to do double work to make up for the time spent in school. He found that it would be far more convenient for him to pursue the study of languages as he could easily carry in his head or pocket a small Greek or

Recollections of Elihu Burritt

Latin book at which he could glance from time to time without interfering with his work at the anvil. His evenings were devoted to the study of French and Latin.

Burritt told his friends that he went to New Haven that he might at least enjoy the atmosphere of that classic city, hoping to be stimulated thereby. He was twenty-two years old, and being naturally diffident, he felt ashamed to ask any one to enlighten or assist him in the rudiments of Greek and Hebrew. He therefore resolved to depend upon his own resources and to seek aid of no one. On his first day in New Haven he took a copy of Homer's "Iliad," which he studied, his sole aid being a Greek Lexicon with Latin definitions. He had never yet read a single line in the book, but resolved that if by hard study and close application he could succeed in translating two lines during the day, he would never thereafter ask aid of any person in pursuing the study of Greek. Before nightfall he had succeeded in mastering the first fifteen lines of the book. This success gave him great courage and confidence which proved a great advantage to him in all his subsequent studies. He now so widened his range of studies as to devote his time each day to French, Greek, Latin, Italian, German, Hebrew and Spanish, giving about half his time to the study of the "Iliad."

In this way the studious youth spent a winter and on returning to New Britain he was induced to accept the preceptorship of an academy in a neighboring town. Here for a year he both taught and studied. But the change from an active life of manual labor to one of sedentary pursuits proved too much for him and his health became greatly impaired. At the expiration of the year he resigned the position and engaged in the more active business of commercial traveler for a New Britain manufacturer, a position he filled for many months, until, in compliance with the earnest wishes of his friends, he decided to

establish himself in the grocery and provision business in his native town. Here he was soon overtaken by the great commercial crash of 1837 and all his accumulated earnings disappeared.

On finding his little property swept away he resolved to start a life anew from the new standpoint. He left his native town and walked to Boston, a distance of more than a hundred miles, hoping either to find the books he sought or some vessel bound to Europe upon which he could go as a sailor and collect at different ports works in the modern and Oriental languages. He was disappointed in not finding either, but accidentally heard of the American Antiquarian Society at Worcester and immediately returned to that place. He there found what he wanted and writes of it as follows:

"Availing myself of the kindness of the directors, I spent about three hours daily at the hall which, with an hour at noon, and about three hours in the evening, made up the portion of the day appropriated to study, the rest being occupied in arduous manual labor. Through the facilities afforded by this institution I have been able to add so much to my previous acquaintance with the ancient, modern and Oriental languages, as to be able to read upwards of fifty of them with more or less facility."

In August, 1838, he wrote a letter in the Celto-Breton language to the Royal Antiquarian Society of France. The accurate use of the language and the knowledge of its structure, evidenced by this letter, attracted the attention of scholars and brought Mr. Burritt into notice as a linguist.

At the age of thirty years he had become more or less familiar with all the languages of Europe and several of Asia, including Hebrew, Syriac, Chaldaic, Samaritan and Ethiopian. At this time he was invited to dine with the late Governor Everett, who, in behalf of several wealthy citizens, offered him all the advantages of Harvard University. This kind offer Mr. Burritt felt called upon to decline, feeling that it would be better for him to combine manual labor with study.

In 1839 he commenced the publication of the *Literary Geminae*, made

First Champion of Universal Peace

up of selections in English and French and designed to be an aid to students in French. This periodical was suspended at the close of the year for lack of financial support.

In 1841 Mr. Burritt first entered the field as a public lecturer and was familiarly known as the "Learned Blacksmith." His first lecture was an attempt to prove that there was no such thing as native agency, but that all attainments were the result of continued effort and application. In illustrating his position he used the well-known story of the boy's climbing the Nature bridge of Virginia. In one season this lecture was given sixty times. Among other places in which it was given may be named New York, Philadelphia, Baltimore, Richmond.

At the close of the successful lecture season, he returned to his anvil in Worcester, working and studying as before, and managing to write a new lecture for the next winter. At this time, cause of anti-slavery was agitating the public mind and it readily enlisted the sympathy of Mr. Burritt who felt that it was worthy of his pen and voice, but certain circumstances led him to devote his time and energies to the cause of peace. He prepared a radical lecture on this subject which he was invited to deliver in the old Tremont Theater, Boston, which had recently been purchased by the Baptist Church. He had a good audience and among them were prominent Baptist advocates, such as Dr. Worcester Ladd and others who cordially endorsed the views of the lecture.

On returning to Worcester he decided to suspend his studies for a season and to establish a paper in the interest of peace, anti-slavery, temperance, etc. It was called the *Christian Citizen* and was the first paper in America that made any considerable step to the cause of peace. It had not a large circulation and yet many copies were circulated through the Northern cities and awakened the interest of many strong minds and did much

good. He edited and published several other periodicals devoted to the cause of peace, anti-slavery and temperance. He also prepared leaflets, entitled "Olive Leaves," which were sent to the weekly and daily papers and were very generally published. He had been in frequent communication by letter with the advocates of universal peace in Europe; and in May, 1846, he sailed for England to meet the friends of the Peace movement, in Manchester, Birmingham, and elsewhere in Europe. He planned to be absent from this country four months, but was induced to prolong his stay to four years. He met with the friends of peace and co-operated with them in devising methods and plans for promoting the cause of universal brotherhood; addressed large audiences in London and other places in England and was active in forming the League of Universal Brotherhood. In connection with this association he commenced the publication of "The Bond of Brotherhood," which explained the principles and objects of the association and was circulated both in this country and Europe.

In September, 1847, Burritt began his campaign for "Ocean Penny Postage" and made more than one hundred and fifty public addresses on the subject in Great Britain. He was much interested in efforts to secure relief for Ireland on the failure of the potato crop and made strong appeals to this country to furnish aid. His appeals were answered by sending a cargo of clothing and provisions from Boston to Ireland.

In 1848 he went to Paris in the interest of the Peace movement to arrange the preliminaries for holding a conference in that city. The internal disturbance and the civil struggle of that year made it impracticable to hold the convention in Paris, but it was determined to hold a meeting in Brussels in the autumn. Mr. Burritt was active in making arrangements for this meeting, and when the Congress was organized he was chosen

Recollections of Elihu Burritt

the vice-president from America. He was active in the proceedings and was much gratified with the results. After the adjournment of the Congress Mr. Burritt, as representative of the "League of Universal Brotherhood," visited many places in England and delivered addresses in favor of arbitration and universal peace.

In April, 1849, he was again in Paris, arranging the details of the great Peace Congress which was held in that city in October. This was one of the most important gatherings of the friends of peace held in any country and Mr. Burritt was one of the secretaries. Soon after the adjournment of this Congress he came to America and to his home in New Britain, where a public reception was tendered him. In reply to an address of welcome, by Professor E. A. Andrews, Mr. Burritt recounted events connected with his visit to Europe. In the course of his address he said:

"I have received many flattering testimonials of consideration and esteem in Great Britain, but the little village of New Britain is the world of my childhood, the birthplace of my first hopes and aspirations, of my first affections; and all the tendrils and fibres of my young and earnest love are thrown around it; and all its interests, and all its inhabitants, with all the glow and warmth of its first strength."

To become reminiscent, I might state that it was at this time, 1850, that I became a member of the faculty of the Connecticut State Normal School. Since 1840 I had been teaching in public schools and academies and was naturally much interested in the tremendous undertaking of Mr. Burritt and the world-wide impression he was creating. His home town, New Britain, was beginning to feel much pride in him. He did not remain much in New Britain during 1850 and the winter and spring of the year was devoted to lecturing in New England and the Middle West. He was also in Washington, D. C., where he met Henry Clay, Joshua Giddings and other men of national reputation, who promised coöperation in the Peace movement. In May, 1850, he again sailed for Europe and visited

the principal towns and cities of England and Germany in making arrangements for the Peace Congress which was held at Frankfort in August. He was accompanied by President Hitchcock of Amherst College and John Prentice and John Tappan, delegates to the Frankfort Congress. It required two steamers to convey the English delegates up the Rhine. All the German states and Italy were represented. America was largely and ably represented. Congress contained among its members many of the most eminent men of the times. The meeting continued three days and was characterized by its statesmanship. He also gave considerable time to the advocacy of "Ocean Penny Postage," both by lectures and conferences with friends of the measure and the officers of government. He was active in preparations for the fourth Peace Congress held at Exeter Hall, London, in 1857, and was secretary of this Congress and one of the speakers at its meetings. Mr. Burritt was present at the Peace Congress at Manchester in 1852 and at Edinburg in 1853. Soon after the adjournment of the latter he returned to the United States and devoted several months to the agitation of the subject of "Ocean Penny Postage." In 1854 he went to England again to advocate the same measure.

In 1855 Mr. Burritt returned to the United States, speaking upon the subject of "Compensated Emancipation" as a proper measure for securing the abolition of slavery in this country. He had met with some encouragement from such men as Sumner, Seward and others when the raid of John Brown put a stop to any hopeful consideration on the subject. He then retired to his home in New Britain and devoted much of his time to the improvement of his land and to efforts to secure improved methods of agriculture in the vicinity of his home.

In 1863, however, Mr. Burritt was again in Europe to carry out a long-cherished plan to pass through Eng-

First Champion of Universal Peace

land on foot that he might observe the methods of agriculture and the system of stock raising. He went from London to John O'Groat's during the summer and early autumn of this year and the next year from London to Land's End, making both journeys on foot.

Under the administration of Abraham Lincoln as president of the United States, in 1865, Elihu Burritt was appointed consular agent for the United States at Birmingham, England. In the following year I went abroad in a desire to visit the principal educational institutions of Europe and at this time, 1866, I visited my fellow-townsmen, Mr. Burritt. I found the business of the office carefully and systematically conducted with the aid of a clerk. Consul Burritt was living in the parish of Harborne, two miles or more from Birmingham. His residence had all the charm of an English home. On the rustic gate, at the entrance of the grounds, was a plate bearing the name, "New Britain Villa." His niece, Miss Strickland, of New Britain, was abroad with him and presided over this charming home. Mr. Burritt was enjoying life surrounded by his English friends. It was interesting to note the respect paid to him at all public meetings and the esteem felt for him by his English friends and acquaintances. At the Peace meetings and other public assemblies he was invited to the platform and given a seat of honor. His modesty often led him to seek an obscure place when he might have had a conspicuous one.

Elihu Burritt's regard for others and his tender sympathy were illustrated by an incident which occurred while I was enjoying his hospitality at Harborne. A neighbor's bird was found dead and the owner attributed its death to Mr. Burritt's pet dog. Though there was no evidence that the dog caused the death of the bird, Mr. Burritt spent hours in looking through the bird markets of Birmingham to find, if possible, a bird more

valuable than the one killed that he might present it to the woman who had lost her pet.

While discharging his duties as consul at Birmingham, he visited officially the principal manufacturing towns in his consular district. These visits led him through the large coal and iron regions and on the conclusion of his visits he published an interesting volume entitled "Walks in the Black Country and its Green Border Lands." He had passed four pleasant years at Harborne, when, on the accession of Grant to the presidency, a change was made in the consular offices and Consul Burritt retired from the office at Birmingham. He received several testimonials from inhabitants and manufacturers of the district; among them was the following from the people of Harborne, presented by the vicar of the parish at a large public meeting:

"HARBORNE, May 26, 1869.

To Elihu Burritt, Esq., Consul and Representative of the United States of America, Birmingham.

Respected and dear Sir

We have heard, with the most unfeigned regret, that your residence amongst us is about to terminate. During your four years of sojourn in the parish of Harborne, we have ever found in you a kind and sincere friend, and a warm and generous supporter of every good and philanthropic work. We are only expressing our heart's true feeling in saying that we deeply deplore your anticipated departure, and shall ever remember, with the liveliest emotions, your oft-repeated acts of courteous kindness. Your aim has always been to forward the interests of the parish from which you are now, on the termination of your mission, about to separate. We are sure that the affectionate regard of the parishioners, generally, will follow you to your new sphere of labor and usefulness; and it is our prayer and heartiest wish that your life may long be spared to pursue your honorable career, so that by your writings, not less than by your example, many may receive lasting good. We take leave of you, dear sir, assured that you will not forget Harborne and its people, on whose hearts your name will long remain engraved. We ask you to accept the accompanying volumes, with this numerously signed address, which we think will, in your estimation be the most assuring token of our deep regard and affectionate remembrance of yourself, and respectful appreciation of your character."

With this address was presented a splendid set of Knight's "Illustrated Shakespeare" in eight volumes. Similar addresses and testimonials came from others who had known Mr. Burritt in Europe.

Recollections of Elihu Burritt

After retiring from his official position he passed several weeks in Oxford and visited other places of interest, calling on friends and acquaintances in England, and returned to America in 1870.

When Burritt returned to us in New Britain it was as the personal friend of the greatest men in Europe,—Victor Hugo, M. de Tocqueville, Joseph Garnier, John Bright, Sir David Brewster, Sir Charles Napier, Professor Liebig, and that whole brilliant assembly of minds that had distinguished the Old World. While he had been the hero of the masses and entertained by nobility, he was still the same benevolent, unassuming Burritt—a statesman and still a blacksmith. One-third of his life on the eastern continent had cultivated his mind, but not at the expense of his heart, for it still throbbed to the time of the hammer on the anvil and his love for the people was as warm as the old forge fire.

During the more than twenty years in which Elihu Burritt had been absent from this country he had been almost constantly before the public, advocating means for the benefitting of mankind. He had also, when in the United States, devoted much of his time to giving public addresses on similar subjects. He had seen great changes in public sentiment in regard to the measures he had advocated and he now returned to the place of his birth and the home of his childhood and youth to pass the remainder of his days in comparative quiet. But he was not idle. His active efforts and his influence set in operation plans and forces, which, in their execution and results, were beneficial to New Britain and the world. His interest in agriculture led him to take an active part in the management of the Agricultural Club of which he was secretary. When its members, with others, organized a grange it was fitly named "The Burritt Grange." Mr. Burritt in a quiet way identified himself with the moral and religious inter-

ests of the community. His desire for mutual effort led him to advocate fellowship meetings of the churches and these were held by the churches of the Conference to which he belonged for many years with interest and profit. He had a building on his farm, which he fitted up for a mission school. He erected in another part of the town a building for Sunday school and religious services, doing much of the work with his own hands. In this building services have been held every Sunday until the present time and it is properly named "The Burritt mission."

While Elihu Burritt was a strong advocate of municipal improvement and good government he would have nothing to do with a party measure. I recall an occasion during my active political years when I was in the public service. A meeting was to be held at which a question was to be decided which was deemed of importance by the political leaders and they were very desirous that Mr. Burritt should be present and vote. I was requested to see him, and if possible, secure his attendance. I called on him at his home and presented the request. He listened to it with attention and then said that he had considered the question and while he thought it important he did not think the decision was of sufficient importance to justify him in voting with either party as by so doing he would be voting in opposition to friends of the opposite party who might have studied the subject more than he had and whose judgment might be superior to his own.

In his years when I knew Elihu Burritt in New Britain he was a friend of children and took a deep interest in their studies and plays. When he visited the schools and spoke to the students he always received close attention and many children and youth were influenced for life by his words. One of the last times that he left his home, and when too feeble to walk even a short distance, he rode in a carriage to a school in which he had

First Champion of Universal Peace

special interest, where he said a few words which deeply impressed those who heard them.

During the latter years of his life, when at his home in New Britain, Mr. Burrirt's knowledge of foreign languages was made practically useful, not only by his translation of letters and legal documents for his friends and the courts, but by teaching classes in Hebrew, Sanskrit and other foreign languages.

I shall state here that this self-educated man is credited with knowledge of some fifty languages. While no one but he ever knew just what were the limits of his learning as a linguist, I can state that he was familiar with, and in many instances a master of, Amharic, Arabic, Basque, Bohemian, Breton-Celto, Chaldaic, Cornish, Danish, Dutch, Ethiopic, Flemish, French, Gaelic, German, Greek, Hebrew, Hindustani, Hungarian, Icelandic, Irish, Latin, Manx, Persian, Polish, Portuguese, Russian, Samaritan, Sanskrit, Spanish, Swedish, Syraic, Turkish, Welsh. He published the first book in Sanskrit ever printed in America.

So remarkable was his proficiency in these languages that Yale College conferred upon him the honorary degree of Master of Arts in 1872, and he was similarly honored by other institutions.

He had been accustomed to make full notes in his travels and his books and journals give abundant evidence of his fidelity to facts and circumstances. Besides the periodicals which he edited both in Europe and in the United States, he was the author of several books, among which were: "Sparks from the Anvil," "Thoughts and Things at Home and Abroad," "Walk from London to John O'Groat's," "Walk from London to Land's End and Back," "Walks in the Black Country," "The Mission of Great Sufferings," "Chips from Many Blocks," "Lectures and Speeches," "Ten Minute Talks," and several smaller books and pamphlets, more than thirty in all. In the study of

foreign languages he had, to some extent, the aid and use of the treasures of antiquarian societies and university libraries, but the dictionaries and text-books which he owned and used form a very interesting collection of more than a hundred volumes which have been placed in the historical room of the New Britain Institute. One of the large grammar schools of New Britain, near his home, has been named "The Burrirt School."

Elihu Burrirt never married and on returning to his native town he found a delightful home with a widowed sister and two nieces who did all that could be done to promote happiness of one so true to them, so honored by the great and good. His last days were passed peacefully and though for weeks before his death he was fully conscious of the near approach of the great messenger he knew in whom he believed and was sustained by an unfaltering trust. To his friends, he spoke calmly of the approaching death and made known his wishes as to the place of burial and matters connected therewith, earnestly desiring that everything might be done in simplicity.

Those of us who knew Elihu Burrirt in his last days loved him most of all for his strong manhood—a manhood shaped at the blacksmith's forge. When he lay awaiting the passing of life into the realm "from which no traveler returns," he remarked to a friend: "I have had a busy and a happy life, but I have finished my day's work. I am now only waiting for that sleep that comes sooner or later to us all."

It was to this same friend that he exclaimed: "I charge you, so far as possible, to see that my funeral services are free from unnecessary expense and all ostentation. Let my coffin be as plain and inexpensive as is consistent with propriety."

It was a few days later on the evening of March 6, 1879. The day had seemed brighter to him than usual. As the shades of night were falling he

Recollections of Elihu Burritt

called his faithful attendant and walking to his bed in an adjoining room, he retired

"Like one who wraps the drapery of his couch
About him, and lies down to pleasant dreams."

As his good friend, Charles Northend, said: "His life at last went out so peacefully that his friends thought him 'sleeping when he died.' Like the flickering flame of a consumed candle, which sometimes brightens

just before it darkens, so the life lamp of our friend, and the friend of all the living creatures of the earth, seemed to give a brighter and softer light just before it went out in darkness to us. . . . It had come forth bearing the precious seeds of peace and good-will to all mankind, and the harvest has been ripening ever since, and in all coming time will the world reap the precious fruits of his sowing."

Extract from Elihu Burritt's Private Journal, recording the eloquent prophesy of Victor Hugo at the Peace Congress at Paris in 1849, the most remarkable assembly that had ever convened on the Continent of Europe

A DAY will come when a cannon will be exhibited in public museums, just as an instrument of torture is now, and people will be amazed that such a thing could ever have been. A day will come when those two immense groups, the United States of America, and the United States of Europe, will be seen placed in the presence of each other, extending the hand of fellowship across the ocean,—exchanging their produce, their commerce, their industries, their arts, their genius,—clearing the earth, peopling the desert, improving creation under the eye of the Creator, and uniting, for the good of all, these two irresistible and infinite powers,—the fraternity of men and the power of God.

"Victor Hugo arose—It was to me a moment of most intense interest—the opening of the great drama. When silence was restored he poured out his mighty thoughts with all the fervid glow of his poetic genius—As the lofty and burning periods fell upon the assembly they responded to their power by repeated bursts of applause—Some of his passages were worthy of being chased in gold"—From Elihu Burritt's Journal



Edwin Bennett

His Favorite Portrait Taken While United States Consular Agent at Birmingham England
Original in Possession of Oscar J. Murray, New Britain, Connecticut

ANCIENT AMERICAN LANDMARKS



AT MILFORD, CONNECTICUT



AT TORRINGTON, CONNECTICUT

Sculpture in America * The First Sculptors and their Hardships in the New World

BY BICKFORD COOPER

SCULPTURE was held by the first Americans as an invention of the devil. The American Indian's conception of it, in its crudest form, was that of a revengeful power—a god of vengeance. The Puritans of New England were brothers to the men who decapitated the cathedral statuary, asserting it to be shameful and immoral. The Quakers of Pennsylvania looked askance upon sculpture and found little in it but suggestiveness. The early Dutch settlers of New Amsterdam were born in a land that was producing masters in painting, but they came to the New World not to potter in clay, but to lay the foundations for large commercial institutions and resultant fortunes. The French and Spaniards were lovers of the sculptural art at home, but America was to them a land of romance and daring where the flesh and the sword were nobler companions than bloodless clay. The cavaliers of Virginia were more in sympathy with the beautiful, and were the first to import works of art into the New World.

The way of the wilderness is stern and relentless. The call from the wilds brings back in its echo the response of man. The rough forest life of the path-finders found sympathy only in throbbing life. One generation passed—and then another—the forest rang with the sound of the axe and the fields blossomed into the fruits of husbandry—still the same stoic disposition which held in disrepute the purely æsthetic bound the characters of the early Americans.

I find that it was a woman who first gave sculptural expression to the American people—Patience Lovell, born at Bordentown, New Jersey, in 1725. Although there was not a statue in that part of the country, she began molding miniature heads in wax. At twenty-three years of age, in 1748, she married Joseph Wright. In 1769, she was left a widow with

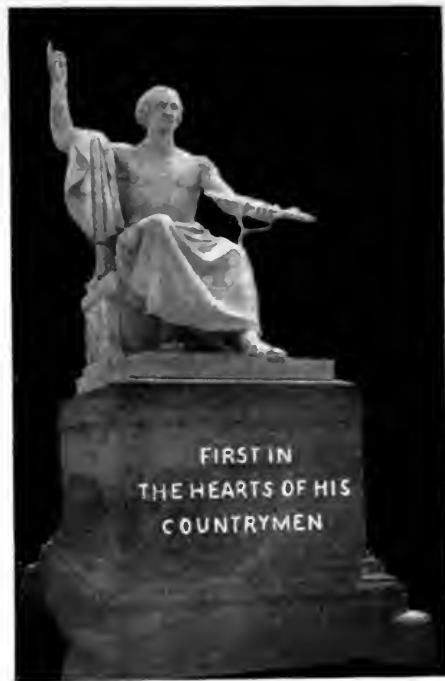

TWO STATUES BY THE FIRST NATIVE BORN AMERICAN SCULPTOR—HORATIO GREENOUGH, A SACRIFICE TO ART



Hardships of First American Sculptors

three children, and removed to London where she believed there were wider opportunities for her talent. Tradition claims that she became a friend of the king, but on the outbreak of the American Revolution she severely upbraided him and became an enemy. For a time she was credited with acting as a spy for the American Revolutionists, and it is said that she kept them informed regarding the shipments of British troops and their destinations. Mrs. Wright corresponded with Benjamin Franklin who was then residing in Paris, and kept in intimate relations with her countrymen. In 1785, she died in London; her son, Joseph Wright, studied with Benjamin West, and returned to the United States as an American painter; her younger daughter married John Hoppner, an English portrait painter.

American blood had been inoculated with art. Interest had now been stimulated in sculpture. Aristocratic homes were beginning to give it recognition, and Mount Vernon possessed marble busts brought from Italy.

Virginia was the earliest patron of sculpture in America, granting to Houdon, a French sculptor, in 1781 and 1785, the commissions to execute a marble statue of George Washington and of Lafayette. Houdon sailed with Franklin from Havre on July 2, 1785, and made the first contribution to the sculpture of the New World.

The second sculptor who visited America was Guiseppe Cerracchi, an Italian, who had worked with Canova upon sculptures for the Pantheon. He came to America in 1791 with the plan to present to Congress a monument to American Liberty—a colossal group, one hundred feet high, in which the Goddess of Liberty is represented descending in a car drawn by four horses, darting through a volume of clouds which conceals the summit of a rainbow. In her right hand she brandishes a flaming dart, which, by dispelling the mists of

error, illuminates the universe; her left hand is extended in the attitude of calling the people of America to listen to her voice. The proposed group included figures of Saturn, Clio, Apollo, Policy, Philosophy, National Valor, Neptune and Mercury. Cerracchi failed to secure the thirty thousand dollars for his proposed work, and tried to accumulate the funds by private subscription. George Washington headed the list of contributors, but the sculptor returned to France disheartened, just in time, according to tradition, to have his head taken off for conspiracy against Napoleon.

It was but a few years later, in 1789, that John Dixey, born in Dublin, came to America with the commendable ambition of founding a school of American sculpture. Many Europeans were deceived with the belief that the land of liberty meant necessarily the emancipation of arts, and they came and went without fulfilling their dreams.

The foreign elements were, nevertheless, making an impression on American craftsmanship. In Philadelphia was one William Rush, born July 4, 1756, and apprenticed as a boy to learn the trade of wood carving, who gained eminence by designing the figure-heads of ships. He served his youth in the American Revolution, and his service to American art is enduring, especially as a founder of the Pennsylvania Academy of Fine Arts in which he united the fugitive elements of American culture. He died January 17, 1833, leaving his impress on the political and intellectual life of his birth-place.

The seed of art seemed to have been planted, and in New Haven, Connecticut, there appeared Hezekiah Augur, born in February, 1791, the son of a carpenter. At nine years of age he was apprenticed to learn the trade of cobbler, but finally became a wood-carver and later the first Connecticut sculptor. He is also credited with producing the first bracket

Hardships of First American Sculptors

saw and inventing the carving machine. In 1833, he was made an honorary member of the Alumni of Yale College, and died in January, 1858.

Contemporary with Rush, was John Frazee, born July 18, 1790, in Rahway, New Jersey. He was apprenticed to a bricklayer, became a tavern-keeper, and later a stone-cutter. He married in 1813, and on the death of an infant son, carved a representation of "Grief" on the tombstone—his first attempt at the human figure. About 1824, he made the marble bust of John Wells, a prominent lawyer of New York, which is probably the first marble bust chiseled in this country, and undoubtedly the first carved by a native American.

In 1792, John Henri Isaac Browere was born in New York, and in his early life went to the Old World to prepare himself as a sculptor. After experiencing two years of adventure, tramping over the continent, he returned to the United States and introduced a new process which gave him position as a contributor to American art.

The first American deliberately choosing sculpture as a profession and going abroad for serious study, was Horatio Greenough, born in Boston, Massachusetts, September 6, 1805. As a child he carved swords and pistols, tiny horses and carriages. At twelve years of age he copied the busts of William Penn and John Adams in chalk. At sixteen years of age he entered Harvard. During the close of his senior year, he boarded a vessel about to sail for Marseilles, after obtaining permission from the government of the college to leave before graduation, and his diploma was forwarded to him abroad. He arrived at Marseilles in the first of the autumn and proceeded directly by land to Rome, where he entered into the art life of the Old World metropolis.

A year later he returned to America, because of ill health, and modeled the bust of John Quincy Adams and of Chief Justice Marshall. In

1827, he returned to Italy, where he began serious work for greater achievements. It was soon after that he made the first marble group by an American sculptor. It was entitled "Chanting Cherubs."

J. Fenimore Cooper, the novelist, saw with great regret the neglect Greenough experienced, and was convinced that he lacked only an opportunity. Raphael's painting of the "Chanting Cherubs" impressed him as a group of great beauty and suited to Greenough's taste. He gave the young sculptor the order, and from the print before him he produced the group. To convince Americans that they had a countryman superior in talent and skill to the Italians they were employing, Cooper placed the group on exhibition. This is the first group from the chisel of an American artist. Puritan decency was shocked by their nude baby forms, and ominous mutterings were heard on every side. Although we have no record of Cooper's instituting a law suit, as was his general custom, the bitterness of the controversy is proved by Greenough's truculent reply to his critics in a letter dated December 1, 1833.

Cooper martialed his influence to force the American people to recognize Greenough as their "first great native sculptor." Through the efforts of the novelist, Congress commissioned Greenough to immortalize Washington as "The Father of His Country." The story of Greenough's "Washington" is a tragedy. He conceived him as a colossal, godlike figure, with lower limbs covered with a loose drapery, and seated in a majestic chair. The statue which was intended for the national capitol met with impudence, ridicule and taunts. After being subjected to much ignominy the figure was placed outside the capitol where it still stands. One satirist, when interpreting the meaning of the extended arms, said that one pointed to Mount Vernon and other to the Patent Office, by which

Hardships of First American Sculptors

he supposed that Washington was saying, "My body is at Mount Vernon; my clothes are in the Patent Office."

I have the deepest sympathy for poor Greenough. For eight years he had labored on an ideal that an unpoetic people could not conceive. With the true soul of the poet he wrote: "It is the birth of my thought. I have sacrificed to it the flower of my days and the freshness of my strength; its every lineament has been moistened by the sweat of my toil and the tears of my exile. I would not barter away its association with my name for the proudest fortune that avarice ever dreamed."

With the storm of ridicule came the unwavering friendship of a few who understood the soul of the young sculptor. Edward Everett wrote from Italy in 1841: "I regard Greenough's 'Washington' as one of the greatest works of sculpture of modern times. I do not know the work which can justly be preferred to it, whether we consider the purity of the taste, the loftiness of the conception,

the truth of the character, or, what we must own we feel less able to judge of, the accuracy of anatomical study and mechanical skill."

I recently read a letter which Greenough wrote to a friend. In it he said: "In future time when the true sculptors of America have filled the metropolis with beauty and grandeur, will it not be worth \$30,000 to be able to point to the figure and say: 'There was the first struggle of our infant art?'"

The tragedy of this first American sculptor closed on December 18, 1852. The depth of this man's soul is shown by some of the last words which he wrote in the closing days of his forty-seven years of life, which had been filled with rebuffs and blasted hopes: "I would not pass away and not leave a sign that I, for one, born by the grace of God in this land, found life a cheerful thing, and not that sad and dreadful task with whose prospect they scared my youth."

It is but the first of the hundreds of tragedies that have been suffered in the building of a national art on the Western Continent.

A SONNET BY HORACE HOLLEY

WHO have drunk the water bitter-sweet,
In whose wan eager lips there gnaws the white
Sad brine from sin's deep goblet bright,—
Sit by the barren well I thought replete,
Its treachery now usen to my sight.
Before me are the ways that part the feet
Of common manhood, sloping from my seat,
And here begins the brooding rim of night.
Many, athirst, dip in the spring for drink
Whom tearfully I bid to cease their lust,
Striking the sparkling cup upon the sand,
And show the water choked with ancient dust.
Then if they flout me with enangered hand
I bare my shame and fright them from the brink.

BEGINNINGS OF AMERICAN ARCHITECTURE



BUILT BEFORE 1800



A SCHOOLHOUSE OF
A HUNDRED YEARS AGO



HOMES OF REVOLUTIONARY DAYS



A HOMESTEAD AND ITS OLD WELL



EARLY PAINTINGS IN AMERICA—Family Group by John Singleton Copley,
The First Native Born American Artist of Exceptional Skill



PAINTING OF BISHOP BERKELEY'S FAMILY BY JOHN SMYBERT, ONE OF THE
FIRST EUROPEAN ARTISTS TO COME TO AMERICA— Now in possession of Yale University
- "It is probably," wrote Horace Walpole, " the first painting of a group of figures in the United States"—

Painting in America & The First Artists and their Experiences on Western Continent

BY STUART COPLEY

PAINTING was little known by the aboriginal Americans, excepting as they used color as a personal decoration in times of tribal wars or revelry. The painters of the Old World found it sufficiently difficult to obtain a livelihood in civilization without coming to the savage land. It is probable that the first artist to dare the dangers of the western continent was the adventurous Jacques le Moyne, who came with the French expedition, about 1565, to the coast of Florida. The stories of his experiences were not such as to induce his fellow artists to follow him. His companions were young Huguenot nobles who came to seek gold, but found famine. They fell into the hands of adventurous Spaniards who slaughtered most of them, but Le Moyne escaped and fled to the woods. In his hiding he saw one of his comrades hewn to pieces before his eyes. After fearful suffering the French artist reached the coast and was picked up by a small vessel and taken to England.

Joannes With, probably from the Netherlands, came to America about 1585 to secure subjects for his art. One or two other courageous illustrators came here for material, but none of them remained any length of time. Samuel de Champlain, the explorer, embellished his records with colored views of harbors, block-houses, animals, rivers, and skirmishes with the Indians.

The early colonists in their migration from the Old World brought no such luxuries as paintings. In truth, most of them had strong religious scruples against art.

Regarding the first foreign artist of real ability to come to America I find some controversy. Mr. Charles Henry Hart, an authority on American art, is confident that Gustavus Hesseluis,

a Swede, was the first painter to arrive in America; and that his son, John Hesseluis, was the first native-born artist. He bases his argument on manuscript written by Wertmuller, in which he records his marriage on January 8, 1801, to a granddaughter "of Gustaf Hesseluis of the Swedish nation, and painter of portraits, who arrived from Sweden in 1710." Accompanying the manuscript are portraits of Gustavus Hesseluis and Lydia his wife, painted by himself, and now owned by the Historical Society of Pennsylvania. Critic Hart says that these portraits "show that Hesseluis was a painter of no mean ability for his time."

Gustavus Hesseluis was born at Volkarna, Dalarin, Sweden, in 1682, the son of a minister. That he was truly a painter is proven by an advertisement in *The Pennsylvania Packet* December 11, 1740:

Painting done in the best manner by Gustavus Hesseluis from Stockholm and John Winter from London. Viz. Coat of Arms drawn on Coaches, Chaises, &c., or any kind of Ornaments, Landskips, Signs, Shew-boards, Ship and House painting, Guilding of all sorts, Writing in Gold or Color, old Pictures cleaned and mended, &c.

Hesseluis was in Maryland for some time, but in Philadelphia in 1735 he purchased a house and lot on the north side of High street, where he resided until his death, May 25, 1755.

The popular opinion in art circles accords the honor of being the first pioneer painter in America to John Watson, a Scotchman, who came to the country in 1715 and set up his easel in a home on a picturesque elevation in Perth Amboy—then the capital of New Jersey—overlooking the sea on one hand and on the other the undulating hills and rich lowlands of the Jersey shore. The most that seems to be known of him is that he purchased lands, built houses, painted portraits, and lived to a great old age

Experiences of First American Painters

in the land of his choice. There were many traditions about him, probably growing out of his thrifty habits of usury and miserliness in his practices. He visited Europe, and Dunlap says in his history of art that he brought back to America many pictures, which, with his own, made the first collection of paintings in this country of which we have any knowledge.

It is said that a good many of Mr. Watson's own pictures were portraits, real or imaginary, of kings of England and Scotland, and that in the Revolution the militia in that section being a rough, undisciplined company, took great delight in destroying the monarchs in effigy, and along with them this first cabinet of fine arts was broken up and its treasures wasted. Watson died in 1786 aged eighty-three years.

I have authority to state here that the first artist to come to America, whose work seems to have made any lasting impression, was John Smybert, a Scotchman, who exerted a powerful and lasting influence on the native-born painters who were his contemporaries and successors. Dean, afterward Bishop, Berkeley, resigned in 1728 the richest church preferment in Ireland for a bare maintenance as principal of a projected "universal college of science and arts" in America, "to instruct heathen children in Christian duties and civil knowledge." He invited John Smybert, a young artist, born in Edinburgh about 1684, who in boyhood was apprenticed to a plasterer and house painter, to be a professor of drawing, painting and architecture in the new institution. The project was a failure and Dean Berkeley returned to Ireland a disappointed man, but still with courage to do more and good work in his own country.

Smybert remained in New England, living in Boston, acquiring fame in his profession as an artist, and fortune by his marriage with a daughter of Dr. Williams, who was "Latin schoolmaster of the town of Boston

for fifty years." Smybert died in 1751, leaving a widow and two children.

There appeared about this time a number of artists and to have one's portrait painted began to be the correct fashion. In 1750, there was one, Theus, painting portraits in South Carolina, Robert Feke in New England, John Greenwood, and several others. In the *New York Gazette*, July, 1754, appears this item:

LAWRENCE KILBURN, LIMNER

Just arrived from London with Capt. Miller, hereby acquaints all Gentlemen and Ladies inclined to favor him in having their pictures drawn, that he don't doubt of pleasing them in taking a true Likeness, and finishing the Drapery in a proper manner, as also in the Choice of Attitudes suitable to each Person's Age and Sex and giving agreeable satisfaction as he has heretofore done to Gentlemen and Ladies in London.

It is doubtful, however, if either art or advertising paid in these pioneer days, for it appears that in 1772 Kilburn abandoned his practice and opened a paint store.

There came to Boston, about 1750, a traveling artist, Jonathan B. Blackburn, who painted family groups and for fifteen years held a select clientele.

The first native American artist of masterly skill was born in Boston, July 3, 1737—John Singleton Copley. He was the son of a Yorkshire farmer who had settled in County Limerick, Ireland, married, migrated with his wife to Boston in 1736, and died in the West Indies about the time of his son's birth. Widow Copley opened a tobacco store in Boston where, according to her notices, she sold "The best Virginia Tobacco, Cut, Pigtail, Spun, by Wholesale and Retail, at the cheapest rates."

About ten years after the death of her first husband, Widow Copley married Peter Pelham, a mezzotint engraver. Under his guidance, the boy Copley made his first portrait—a painting of his stepfather. About the time he was seventeen, young Copley had become recognized as a painter,



171
PORTRAIT OF MRS. FORD BY JOHN SINGLETON COPLEY. FIRST
NATIVE AMERICAN ARTIST WHOSE WORK PORTRAYED GENIUS—
Now in the Art Gallery of the Wadsworth Athenæum at Hartford, Connecticut

Experiences of First American Painters

and his work already included a miniature of Washington, whose reputation was then that of a brave Indian fighter. He married, in 1769, the daughter of Richard Clarke, a wealthy merchant. Copley considered his wife the most beautiful woman in America and he introduced her into many of his paintings.

The Copley home was an eleven-acre farm on Beacon Hill, Boston, and in 1767 he wrote: "I am now in as good a business as the poverty of this place will admit. I make as much money as if I were a Raphael or a Correggio, and three hundred guineas a year, my present income, is equal to nine hundred a year in London."

Nevertheless, he sailed for England, in June, 1774, and from thence to Italy where he passed the winter in Rome. In a letter to his wife from Genoa he writes:

"I judged it best to take advantage of so good an opportunity and purchased a suit of clothes for the winter. Perhaps it would amuse you should I tell you what I have bought. I have as much black velvet as will make a suit of clothes. For this I gave about five guineas (\$25), and about two more for as much crimson satin as will line it. This is the taste throughout Tuscany; and to-day I have bought some lace ruffles and silk stockings."

Because of political disturbances in America, he sent for his family who joined him in July, 1775. It is said that "Mrs. Copley left behind her in America, Mrs. Pelham, the artist's mother, and in her care an infant only a few weeks old, which she was afraid

to expose to the trials of an ocean voyage, and which died soon after. She took with her three children, and was soon afterward joined by her father, Mr. Clarke, and her brothers, who had previously moved to Canada. Mr. Clarke was a strong Tory. It was to him that the tea was consigned which was dumped into the harbor at the 'Boston Tea Party,' and in other ways he suffered so heavily for his views that he subsequently received a pension from the British government up to his death."

Copley was inclined to favor the American party in England, but took no part in the dispute. It was on December 5, 1782, that he listened to the king's speech recognizing America's independence. At that time he was working on a portrait in the background of which he had introduced a ship, and upon receiving the news he painted on the ship's mast the first American flag seen in England.

Copley's career in London carried him to renown, and then began to decline. During his prosperity his mansion was opened to all Americans visiting London, but when fortune turned he became involved in financial difficulties and borrowed money to advance his son. It is told that "patronage fell off; almost his last important work, the equestrian portrait of the Prince Regent, from which he had hoped great things, remained unsold; his health declined, and his life did not long outlast his popularity." He died in 1815 and was buried in the parish church at Croyden.

"All are architects of Fate,
Working in these walls of Time!
Some with massive deeds and great,
Some with ornaments of rhyme.

"Nothing useless is and low;
Each thing in its place is best;
And what seems but idle show
Strengthens and supports the rest.

"For the structure that we raise,
Time is with materials filled;
Our to-days and yesterdays
Are the blocks with which we build."

Music in America *&* The Struggles of the First Composers Against Public Condemnation

BY CLARA EMERSON

MUSIC in America traces its first melodies to the quaint chants of the savages. The American Indian interpreted all the emotions of life into song.

He had songs to nerve the warriors, to give zest to sports and games, and to speed the spirits to the happy hunting-ground. I find a quaint custom in one tribe. Upon the death of a prominent person, the young men of the tribe made two incisions on the left arm and under the lip of the flesh formed put a willow twig. With the blood dripping from their arms, they marched to the place where the body was lying, singing a song of happiness. It was their belief that the spirit of the dead person could hear the song and that it would cheer him in his journey. The bleeding arms were supposed to show their sympathy and love.

With the coming of the white man the first Virginians brought the folk-songs of old England. The first native singing in America were the Psalms chanted in Puritan religious services. Songs and music of all kinds were held in distrust. The "Bay Psalm Book," published in 1640 at Cambridge, Massachusetts, was the first book printed in the colony. For some time previous to this but five tunes were permitted. These included "Old Hundred" and "York." It is believed the other three were "Hackney," (sometimes known as St. Mary's), "Winsor," and "Martyrs." Hymns began to be used in 1647.

A deep theological problem confronted the Americans of about 1648. I find evidence of a vigorous movement to confine singing to the few "elect of God," allowing the congregation to join only in the final "Amen." Many even considered skilful singing as wickedness. These questions created serious controversy:

Whether women, as well as men; or men alone may sing?

Whether carnall men and Pagans may be permitted to sing with us, or Christians alone, and Church-Members?

Whether it be lawful to sing Psalmes in Meeter devised by men?

Whether in Tunes invented?

Whether it be lawful in Order unto Singing, to reade the Psalmes?

The evidence by which singing was declared a sin was based on three findings: First, that tunes are inspired; second, that to sing man's melody is only a vain show of art; third, that God cannot take delight in the process where the man of sin has had a hand in making the melody.

There were, however, some daring liberals who sacrificed their reputations in the cause of music, and as early as 1717 a singing school existed in Boston.

About 1673 it was attempted to found a school in which the feet were taught to keep time to music. The willful instructor was named Stenney, but he was arrested and fined one hundred pounds.

The singing school caused another discussion in which this query was foremost: "Is it possible that fathers of forty years old and upward can learn to sing by rule? And ought they to attempt at that age to learn?"

The importation of a church organ from London to Boston in 1713 created consternation. It was placed in King's Chapel, and many preachers denounced it in their sermons. It was termed "boisterous," and it was insisted that it could never be "justified before the great master of religious ceremony." It was at this time that choir singing developed through the singing schools.

Then came the first American composer—William Billings, born in Boston, October 7, 1746. He was apprenticed to a tanner and wrote his first composition with chalk upon the side of leather in the tannery. Despite

Struggles of First American Composers

the ridicule to which he was subjected, he published "The New England Psalm Singer, or American Chorister," in 1777. Upon hearing his first composition sung by a church choir, this first American composer in his enthusiasm recorded his feelings thus:

"It has more than twenty times the power of the old slow tunes, each part straining for mastery, to keep the audience entertained and delighted, their minds surpassingly agitated and extremely fluctuated, sometimes declaring for one part, and sometimes for another. Now the solemn bass demands their attention, next the manly tenor; now the lofty counter, now the volatile treble. Now here, now there; now here again—O ecstatic! Rush on, you sons of harmony!"

The true American spirit of progress is shown in the introduction which Billings wrote for his compositions. He said:

"Perhaps it may be expected by some, that I should say something concerning Rules for Composition; to these I answer that *Nature is the best dictator*, for all the hard dry studied rules that ever were prescribed, will not enable any person to form an Air, any more than the bare Knowledge of the four and twenty letters, and strict Grammatical Rules will qualify a scholar for composing a piece of Poetry, or properly adjusting a Tragedy without a Genius. It must be Nature, Nature must lay the foundation, Nature must inspire the Thought. . . . For my own part, as I don't think myself confined to any Rules for Composition laid down by any that went before me, neither should I think (were I to pretend to lay down rules) that any who come after me were any ways obligated to adhere to them any further than they should think proper; so in fact I think it is best for every Composer to be his own Carver. Therefore, upon this consideration, for me to dictate, or pretend to prescribe Rules of this Nature for others, would not only be very unnecessary but also a very great piece of Vanity."

This first American composer soon won the hearts of the people. He was a patriot during the American

Revolution and many of his tunes were heard around the camp fires of the Revolutionary Army, or the notes of "Chester" from the fifers of the Continental ranks.

Music, however, did not prove a profitable occupation and he suffered poverty. He gave his life to the muse regardless of the taunts of his fellowmen. It is said he was the first to use the violoncello in church music in New England, and he is credited with being the first to introduce concerts in the colony. Billings was an eccentric man, physically deformed, defective in sight, and untidy in personal appearance and habit. His family was so distressed by poverty that the assistance of the community was solicited. Billings had a sign over the door of his house on which was inscribed "Billings' Music." I have heard the story told that one night two cats were suspended from it by their tails and that their howls aroused the entire neighborhood. The ridicule to which he was subjected is also shown by the query which he received, asking if snoring was to be classed as vocal or instrumental music. After a rather turbulent career, this first American composer died September 29, 1800. Of him a modern music critic says: "Beethoven could have obtained no audience in America in the Eighteenth century, but Billings found a willing audience and cheered many a fireside and camp where higher art would not have been introduced."

I have been searching for the grave of this first American composer. While it is known that he was buried somewhere in the cemetery on Boston Common, it was unmarked. The cemetery still exists, but it does not seem possible to discover the exact spot where the first American composer was laid at rest.

BEFORE MAN FOUND A NAME FOR ANY THOUGHT, OR THING, HE HAD HOPES AND FEARS AND PASSIONS AND THESE WERE RUDELY EXPRESSED IN TONES



IMMUTABILITY.

Ye noble records of the centuries!
Ye living witnesses of ages dead!
Ye kingly comrades true, whose stout brave fight
For life, throws hope's eternal light ahead
Upon our paths full of obscurities!

Teach us that 'tis by every conflict won
The knotted sinews grow, which give strength, calm
And confident, and in the flash and roar
Of storm, feel, with sure touch, the coming balm
Of the restoring rain and faithful sun.

Frank Burnham Bagley

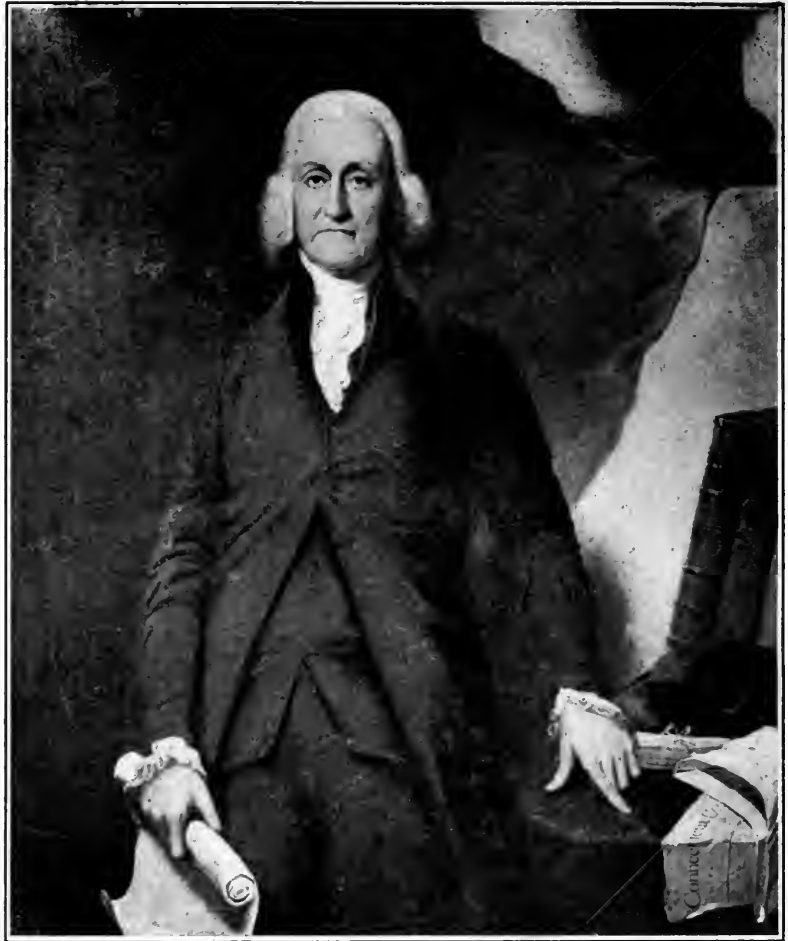

Jon. Trumbull

"Scribe" of the Old Philogrammatican Library at Lebanon, Connecticut
One of the First Libraries in America, 1738

Book Lovers of 1738—One of the First Libraries in America

*The Literary
Inclinations of Early
Americans & The Books they Read and
their Learned Discussions on Matters Intellectual
and Moral & A Treatise on "Physick" was the Foundation of Literary
Culture in the Discriminating Judgments of the First American Bibliophiles*

BY

MRS. MARTHA WILLIAMS HOOKER

GREAT-GRANDDAUGHTER OF ONE OF THE FOUNDERS OF THE "PHILOGRAMMATICAN" LIBRARY

AN old record book, bound in parchment and yellow with age, has come down to me from my great-grandfather. It is the original record of one of the first libraries in America. Most of it is in the handwriting of the first Governor Jonathan Trumbull of Connecticut when he was a young man, and at the beginning of the notable career which later distinguished him as one of the leading jurists and patriots of the early days. This old record has defied the lights of time for one hundred and sixty-eight years and the entries are still distinct.

In this ancient record book is revealed the life-story of the old library in historic Lebanon, Connecticut, beginning in 1738. But even at that time we find that "the Book Company of Durham, Connecticut, was instituted on the 30th day of October, Anno Domini, 1733," and therefore must have been five years older than its little sister in Lebanon with the long name of "Philogrammatican."

The name itself is sufficient to discredit any statement that the early

New England people were unlearned or that they gave scant interest to literary matters. The truth is that these pioneer Americans were not only book lovers but scholars; even more, they were pedagogues. Look, for instance, upon the clerk who inscribed the minutes of the old "Philogrammatican" library. Jonathan Trumble, as his name was then spelled, was the son of a country merchant, and a graduate from Harvard in the class of 1727. He studied theology with the clergyman, the Reverend Solomon Williams, but upon the death of an older brother abandoned the study and went into his father's business. At that time many of the goods came from foreign countries by ship to New London, and thence by teams to the inland towns of Connecticut and Massachusetts. These men were owners of some of these importing vessels.

Trumble was about twenty-eight years old when this Library Association was formed and he was chosen as its "scribe."

The village clergyman, the Reverend Solomon Williams, was one of the most ardent promoters of the plan

Literary Inclinations of Early Americans

to develop a system of co-operative reading whereby the minds of his community might be nourished with intellectual food. The pulpits of the meeting-houses were occupied by the most learned men of the new land and Reverend Williams was a type of the old-time scholar, descended from several generations of scholarship. He was the son of Reverend William Williams of Hatfield, and the grandson of Reverend Solomon Stoddard of Northampton, Massachusetts, as was also Jonathan Edwards, the eminent theologian and president of Princeton College.

His elder brother, Elisha Williams, was rector (or president) of Yale College for thirteen years. Reverend Williams was settled over the flock in Lebanon in 1722 when he was only twenty-two years of age. He married Miss Mary Porter, whose father was Judge Samuel Porter of Hadley, Massachusetts. The youthful minister and his bride had matured under the grandeur of Holyoke range which cast its shadows on the blue Connecticut, winding through green and fertile meadows.

The first parish of Lebanon, to which they came, was the home of a goodly number of intelligent families. It was an atmosphere of refinement and culture. The inhabitants of the town were a studious people and eagerly digested all bits of information that came from the Old World, especially such rare intellectual feasts as a printed book from Old England. There were frequently expressed desires that some way might be devised for giving them better literary opportunities, and in 1738 practical measures were taken for this purpose.

It was thirty-eight years before the outbreak of the American Revolution and the radicalists had not organized any definite plan for remedying existing evils. There was time for literary pursuits, especially with the conservative colonists who

had full faith in an ultimate peaceable disposition of affairs.

It was well, then, that the book-lovers of Lebanon should institute a library, which, modest as it may now seem, was a notable factor in the mental development of early America.

Those with literary inclinations from far and near cordially indorsed the proposed undertaking. Clergymen from the different communities became interested in the movement and joined the Library Association, conferring upon one another the title of "Covenanter" and approaching the responsibility with a reverence that must have verged on bibliolatry.

Unlike modern library associations, there was no constitution, no president or board of officers, but a strictly legal covenant was entered into between the Reverend Solomon Williams on the first part, and the leading men of his town, physicians, merchants and lawyers, together with clergymen of adjoining towns on the other part. Each one agreed to contribute fifty pounds, or two hundred and fifty dollars, to purchase books. Reverend Williams was treasurer, although no mention is made of such a title, and Jonathan Trumbull, secretary, or, as he was called, the "Scribe."

The covenant of the old book-lovers is not unlike many of the manuscripts of the scholarly inclined of the present generation. The young college graduate who inscribed it seems to have a very human relation to his collegiate brother of to-day, and was undoubtedly better informed in Greek and Latin than in the orthography of his own language. His handwriting, which lies before me, is so legible, however, that I pardon his excessive use of capital letters for they certainly are quite ornamental.

"The Covenant," I here transcribe from the original entry in the old record-book before me, preserving the quaint spelling and capitalization:

COVENANT OF THE EARLY AMERICAN BIBLIOPHILES

TRANSCRIBED FROM ORIGINAL RECORD BOOK OF THE
"PHILOGRAMMATICAN" LIBRARY AT LEBANON, CONNECTICUT

This Covenant made this 4th Day of Jany., Anno Domini, 1738. Between Eleazur Williams of Mansfield, Joseph Meacham of Coventry, Thomas Clap of Windham, Jacob Eliot, Eleazur Wheelock, Ebenezer West, Ebenezer Gray, Joseph Fowler, Gersham Clark, John Williams and Jonathan Trumble, (all of Lebanon,) in the County of Windham and Colony of Connecticut in New England, on the one Part—and Solomon Williams of the said Lebanon on the other Part. Witnesseth—That we, the above named—Do Covenant and agree to, and with the said Solomon Williams, His Heirs, Executors, in manner and form following—viz.

COVENANT

We Do Each and Every of us, Severally Oblidge ourselves, our Heirs—Executors, and Administrators To pay, or Cause to be paid, unto The Said Solomon Williams, His Heirs or Order the full and just Sum of Fifty Pounds Current money, That is, Twenty Five pounds, at or before the first day of September Next Ensuing, and Twenty-five pounds at or Before the first day of September which will be in the Year of our Lord 1740. All and Every of which Fifty Pounds by Each and Every of us Agreed and Covenanted To be Paid; we do hereby Covenant and Agree shall be by Said Solomon Williams his Heirs, Executors and Administrators Used and Improved to Purchase and Buy a Library of such Usefull and Profitable Books, as the Covenanters by Their Major Vote Taken and Given in manner hereafter to be Expressed shall be Agreed and Concluded upon; to be Holden and Kept in the first Society in Lebanon Aforisd, as a Common Library among the Covenanters, for Their Use and Improvement Under such Restrictions, Regulations, and Directions as hereafter in this Instrument shall be Expressed, or in Due manner and form shall be Agreed—Voted and Concluded on by the Proprietors and Covenanters aforesaid. Whereupon: The Said Solomon Williams doth for himself, his Heirs, Executors and Administrators Covenant and Agree to and with the above named.

. . . (Names of Proprietors follow.)
Their Heirs, Executors, Administrators and Assigns that he the Said Solomon Williams, His Heirs, Executors, Administrators, shall well and Truly Pay or Cause to be paid toward the afores'd. Out of his Own Proper Estate The full and just Sum of Fifty Pounds money, To be paid Towards the Use aforesaid. In manner

and form as the Several Fifty Pounds aforesaid. That is Twenty Five Pounds at or before the First day of September next, and Twenty Five Pounds at or before the First day of September which will be in the year of our Lord 1740—And then further—Secondly the aforesaid Solomon Williams doth bind and oblige himself, his heirs &c to Purchase and Deliver into the hands of the Covenanters aforesaid, a Collection of such books and such sort of books as shall be agreed upon and concluded, to be bought by the vote of the major part of the Covenanters, made as hereafter expressed, which shall amount in the whole, to the whole of the Several sums covenanted to be paid by the Covenanters on the first part, To the said Solomon Williams Together with the fifty Pounds covenanted and agreed by him to be, added to the same Totall amount at the Cheapest Rates they can Reasonably be purchased in New England to be delivered at or before the first day of September next—one half of them—and the other half of them, at or before the first of September A D 1740.

Whereupon it is now further covenanted and agreed and Determined to, by and among all and every of the Covenanters both on the one and other part mentioned in manner and form—following—

That the said Collection of books made and Purchased as aforesaid, shall be put into a comon Library, and shall be held and kept within the Limits of the first Society in Lebanon aforesaid, for the Comon use, benefit and Advantage of the Covenanters aforesaid, and those of their heirs and assigns as by the vote agreed on by the major part of the Proprietors shall be allowed to Take and hold Interest Therein.

(OVER)

COVENANT OF EARLY AMERICAN BIBLIOPHILES (Continued)

Secondly, That the said Library shall be called by the name of the Philogrammatican Library, and that the Proprietors and owners Thereof in Relation thereto shall be called and known by the name of The Company of the Philogrammatican Library.

Voted—That the said Solomon Williams shall be the keeper of the said Library until the Proprietors of the same shall by their vote Regularly given order otherwise.

Voted that a True Record "Shall be kept and Entries made of the votes and Doings of said Company. It is agreed that a Book shall be made and kept by some person thereto appointed and that from time to time two persons shall be appointed, Truly to Enter all the votes, proceedings and orders of the Covenanters and proprietors of said Library in the said Book for that End provided and shall subscribe their names thereunto which shall become evidence that These Records or Entries made were the acts and doings of said Company—

It was also voted—That Three Covenants of Like Tenour and date, shall be duly executed by each of us—which Covenants so executed Shall be lodged in the hands of the Library keeper. It was also voted that a true copy shall be made of the Covenant, and transcribed in the forepart of the Book Wherein the votes, and doings of said company are recorded. Voted that other Covenanters may be admitted and received to make additions to said Library by the major vote of the Company who shall be under the like Restrictions Regulations and Directions as the present Proprietors are.

In witness whereof Both Parties and each member of both Parties here subscribe their Hands and Seals to Three Covenants of like Tenour and Even Date with these presents, one of which being

accomplished the Rest shall be discharged Signed, Sealed &c in presence of us. Here follow the names.

WITNESSES

Ralph Wheelock (L S)
Eleazur Gillet (L S)
Eleazur Williams (L S)
Joseph Meacham (L S)
Solomon Williams (L S)
Thomas Clap (L S)
Ebenezer West (L S)
Joseph Fowler (L S)
John Williams (L S)
Jacob Eliot (L S)
Eleazur Wheelock (L S)
Ebenezer Grey (L S)
Gersham Clark (L S)
Jonathan Trumble (L S)

The Covenant contained on Three preceding pages is a true and perfect Transcript of that made and executed by The Company of the Philogrammatican Library —In Witness whereof we here by the order of the said Company subscribed

Our names—
(as above)

JON'TH TRUMBLE—
Clerk—

At a later meeting it was also

Voted—That each Proprietor may borrow Books to the Value of Twenty Pounds at a time and no more—

Voted—That Jonathan Trumble be appointed to buy tanned sheepskins—and get the Books already brought into the Library covered with them—and that It be Done as Speedily as may be with Conveniency—at the Charge of the Company.

I should like to here place before you the interesting records of each one of these meetings of the good bookmen, for every page of the old witness which they left behind draws one nearer to them, and one soon feels an intimate acquaintance with the select literary circle and can almost hear them discuss the literary quality of the books of the day, gathered undoubtedly in a large hospitable room in which a severely plain table, some straight-back chairs and a glowing fireplace are the principal objects of luxury.

Can you not see in your imagination the pious and reverend Parson Williams, questioning the propriety or moral influence of this book and that, protesting against frivolity and appealing to the philosophical instincts that were so strongly developed in the wilderness life of the early Americans. Possibly Jonathan Trumbull, who was some ten years younger and knew something of politics, supported a more lenient policy and suggested an occasional volume that would meet the popular fancy. Whatever may have been these dis-

Literary Inclinations of Early Americans

cussions—and discussion there surely must have been, for whoever heard of a literary gathering that could agree upon what literary quality really means—the old record-book settles them all with this decisive statement that the first purchase was:

THE BOOKS OF PHYSICK

Dr. Gray and Dr. John Williams were appointed to get a proper catalogue and deliver to Rev. Solomon Williams in order to their being purchased. And that £40 of the first purchase be in Law Books, and that Messrs. Eliot, Fowler, and Trumble procure and deliver a proper catalogue as above said—

A Catalogue also of Sundry other Books. Voted: That Rev. Solomon Williams and Rev. Jacob, Eliot and Messrs. Eben Gray, John Williams, and Jonathan Trumble be a Com. to look over, settle and sort the catalogues and the first mentioned in these catalogues by them to be bought first.

It is evident that the original "Covenant" proved insufficient to meet the emergencies of book buying and book loaning, for in 1740 an additional "Covenant" was made in which the desire is expressed that "*this Library remain one joint Library from Generation to Generation.*"

Circumstances which these good men could not foresee prevented this idealistic accomplishment. The development of the library, however, was well directed, and in 1843, at a meeting held on August 8, this record appears in the book before me:

Voted that the Company would now proceed to purchase the Remaining part of the collection of books and that the Rev. Solomon Williams be desired to Procure a bill of Exchange and send it to London this Fall in order to have the books from thence next Spring and that he take the best method for obtaining them at the Cheapest sterling price and order them

insured home and the company agree to pay their respective quota to the Rev. Solomon Williams on or before the fifteenth day of October next. This meeting was adjoined by vote of the Company until the 26 of September next. The foregoing votes truly entered by

JON'TH TRUMBLE, Scribe.

This was the last meeting to be reported in the handwriting of Jonathan Trumbull in this old book. Possibly politics diverted his interest from literature. Possibly he continued in the literary circle but inscribed his minutes in another book which has failed to find its way down the channel of the generations. I have made persistent inquiry among the other descendants of the Reverend Solomon Williams, and also in the Trumbull family, but fail to support this later possibility. This, indeed, was a period of increasing activity. There were troubles brewing and politics may have demanded the entire attention of the scholars.

The old record-book is silent—severely silent, and for a period that gives rise to a multitude of probabilities. It is silent for forty-three years! From 1743, through that tragical sweep of time in which occurred the American Revolution, the ancient volume does not speak until the twenty-seventh of November, 1786. What a drama of human passions had been played in this long interval. What tremendous clashes of powers had taken place, and what a staggering blow had been struck to tyranny. The British Empire had lost its rich colonies in America. The American people had declared, bled for, and established their independence. A young giant had entered the arena in the conflict for the world's supremacy, and the United States of America stood a free nation before the peoples of the earth, inviting them to break the chains of monarchy and come and partake of the cup of Liberty.

Literary Inclinations of Early Americans

Once again the seared old pages speak in 1786:

27th Noyember 1786: Present Eleven Members—Mr. Oliver Huntington was chosen Moderator—Dr. Thomas Williams chosen clerk—The question was canvassed whether or not the Company be dissolved and the books divided, it was voted to keep and continue the Library. Voted that Dr. Thomas Williams shall be Librarian for the present. Voted that Rev. Zebulon Ely shall be the Librarian at the time when he shall purchase a share in said Library.

Truly entered Thomas Williams
Clerk.

Turning over the pages it is found that there was held:

a Meeting on Sep. 25, 1792; there were present

Rev. Zebulon Ely
Rev. Stephen White
Rev. James Cogswell
Oliver Huntington
Eben West
Dyer Hinckley
Thomas Williams.

His Excellency Samuel Huntington Esq
Ebenezer Grey
Peleg Thomas
Jacob Eliot
deceased

} By their attorneys

Voted to Divide the books belonging to The Philogrammatican Library to Each Proprietor on equal shares—said vote implying of consequence the Dissolution of the Company—

Voted that Rev. Zebulon Ely, Oliver Huntington, and Thos. Williams, make just distribution and to meet and divide the books by lot.

THOMAS WILLIAMS Scribe.

When one considers the events that passed through the first decades of the life of the "Philogrammatican" Library it seems remarkable that it could have existed at all, and if it was deserted by men who found war of greater immediate consequence than intellectual development, it is a significant fact that it again claimed their attention after the laying down of arms in the great struggle. Even before the Revolution the French and English War had occurred, and men and money had been given to the expedition against Annapolis and Louis-

burg, which was led by Colonel Lathrop of Norwich. Lebanon had spent so much in men and money in the Revolutionary War that they could not purchase new books in 1792.

The small boys who had played in the grass-grown streets of the quiet and secluded village of Lebanon had become men and offered their lives as a sacrifice to the cause of liberty.

Jonathan Trumbull, the "scribe," had become Honorable Jonathan Trumbull, the legislator and lawyer, and the beloved "Brother Jonathan" the intimate friend and "right-hand" confidanté of General Washington, who relied much upon his judgment and service in directing the American Revolution.

Reverend Solomon Williams had died in 1775, just before the dawn of liberty and his sons had fallen heir to the literary pride of their father in the "Philogrammatican" Library. Thomas Williams, the "scribe" of the library who had some time succeeded Jonathan Trumbull, had been graduated from Yale College and settled as a physician in his native town. William Williams, his brother, had been graduated from Harvard College, and had seen service in the French and English War on the staff of his relative, Colonel Ephraim Williams, founder of Williams College, Massachusetts, at the Battle of Lake George. He had represented his old town in the General Assembly and had been a distinguished member of the Continental Congress in 1776. Moreover he had forever perpetuated his name by inscribing it on that "roll of fame," the Declaration of Independence. His wife was a beautiful woman, Mary Trumbull, the daughter of his old friend, Jonathan Trumbull.

The good bookmen who had organized the "Philogrammatican" Library in 1738 had most of them passed away in the lapse of forty-three years which the mute record-book fails to

Literary Inclinations of Early Americans

divulge, and in 1786 those who were still living were in venerable and inactive age and had long since left the responsibilities of life on younger shoulders.

Thomas Clapp, one of the first "Covenanters," rose from the ministry in Windham to the presidency or rectorship of Yale College. This distinction was conferred upon him the first year after the establishment of the library, in 1739, and he fulfilled its duties until 1766. "He contributed much to improve Yale College and was the means of building a new edifice and chapel. He was a man of extensive learning and gave great attention to mathematics and astronomy, and constructed the first Orrery made in this country."

Eleazur Wheelock, another of the select circle of bookmen, became an educator. He was first a teacher of Indian boys in Lebanon, and later removed his school to Hanover, New Hampshire, where many of the aboriginal Americans were led to civilization and learning. From this work developed Dartmouth College, of which he was president, as was also his son.

Eleazur Williams, an original "Covenanter," was the son of the Reverend John Williams of Deerfield, Massachusetts, who was carried to Canada by the Indians in 1704. The son, Eleazur, escaped capture at the same time only because of his fortunately being away from home—at college—for all the other members of the family were taken captives. The son, after his college years, settled in Mansfield as a minister.

Joseph Meachem, still another of the literary clique, was also a clergyman, and married a sister of Eleazur Williams. She was taken captive with her father and family by the Indians, but after reaching Canada she was rescued by the French and was placed in a school in Montreal where she received two or three years of superior training. She was returned to the colonies with her father and younger brothers in 1707.

There were many new faces at the meetings of the Library Association in 1786. Reverend Zebulon Ely was then the village minister, having succeeded the late Reverend Solomon Williams. His Excellency, Samuel Huntington, governor of Connecticut, was a member of the association for a short time. He was a personal friend of William Williams, and with him signed the Declaration of Independence.

Then came the decade of constructive energy, when men gave the best there was in them to the laying of the foundation of the new nation. Literary pursuits were left largely to men who made a business of it. The newspaper press became well established. The post-boy brought the news regularly, and in 1792 the old "Philogrammatican" Library passed into history.

These old bibliophiles did their work well and nobly. May all good bookmen of the years to come exercise the same discrimination and conscientiousness as did these pioneer American bookmen of one of the first literary clubs on the Western Continent.

LICENSE TO MAKE BOOTS AND BOOTEES IN 1815

TRANSCRIBED FROM ORIGINAL BY BENJAMIN C. LUM

WHEREAS David Lum Junr of the County of New Haven in the State of Connecticut hath duly applied for a license to employ a manufactory conducted in one wood building, situate in the county of New Haven in the State of Connecticut and owned by Sd Lum of the county of New Haven in State of Connecticut in the making of BOOTS and BOOTEES during the term of one year to commence on the eighteenth day of April 1815 and to end on the eighteenth day of April 1816:

NOW KNOW YE, That the said David Lum Junr is hereby licensed to employ the said manufactory in the making of BOOTS and BOOTEES, for the said term of one year as above defined, in conformity with the laws of the United States.

Countersigned at Cheshire in the Sd Collection District this 18th day of April, 1815.
S. Hull Jr., Collector of the Revenue for the Collection District.

WALTER B. BEALE

**BOOKS IN ONE OF FIRST LIBRARIES IN AMERICA
VOLUMES SELECTED BY BOOK LOVERS IN 1738**

Transcribed pages from the Original Record Book of the Philogrammatican Library at Lebanon, Connecticut, giving an accurate idea of the literary inclinations of the pioneer Americans. Reverend Solomon Williams, a prominent book-lover of his times, made two or three trips on horseback to Boston to learn the latest literary news and then sent to England for most of these volumes.

Ninety-four books were recorded in 1739, others were added in 1743.

<i>Page 1 of Original Record Book.</i>		No. of Vols.	£	s	D
Folios—					
Rapin's Hist. of England		2	2	7	
Chambers' Dictionary		2	4	10	
Cambden's Britannia		2	2	14	
Calmet's Dictionary		2	5		
Burnet's History of His Own Times.....		2	2	8	
Barrow's Works		2	1	15	
Tillotson's Works		3	2	5	
Saurin's Dissertations.....		3		10	6
Bates' Works.....	£1 0 0				
Flavel's Works	1 10 0				
Edward's Theologia Reformata.....	1 15 0				
Stillingfleet's Origines Sacra.....	0 15 0				
Coke's Institutes	3 0 0				
Lilly's Abridgement.....	2 0 0				
Quarto's—					
Guise's Paraphrase, his gift to us.....	0 15 0,				
Wollaston's Religion of Nature, &c.....	0 5 3				
Winslow's Anatomy.....	Sterling price			14	0
History of Popery—Gift of Mr. Jno. Oswald, 2 vols.	£0 15 0				
Octavo, &c.					
Coke's Reports	7 vols. 2 0 0				
Bohun's Declarations and Pleadings.....	Sterling			5	0
Jacob's Introduction to Common Civil and Canon Law.....	Do.			5	6
£13 15 3			£22	17	
<i>Page 2 of Original Record Book.</i>					
Gentlemen Instructed	£0 5 0				
Colamy's Abridgmt. of Baxter's Lives.....	0 10 0	2			
Prideaux's Commition, &c.	0 17 0	3			
Ditton of Christ's Resurrection	0 5 0				
Ray's Wisdom of God in Creation.....	0 4 0				
Sherlock on the Soul's Immortality.....	0 4 0				
Sharp's Sermons	0 12 0	4			
Wilkin's, Principles of Natural Religion.....	0 4 0				
Buxtorffie, Synagoga Judaia	Sterling			4	
Langii Medicina Mentis	do.			4	6
Grabii Spuilegium Patrum	do.	2		6	
Sir Isaac Newton's Opticks	do.			5	
Chamberlain's Present State of Great Britain .	do.			6	

	Sterling	No. of Vols.	£	s	D
<i>Page 2 of Original Record Book (continued).</i>					
Waterland's 1st Defence and Further Vindication.....	do.			6	
Waterland's 2nd Defence and Further Vindication.....	do.			6	
Waterland's Sermons	do.			5	
Brown's Procedure of Human Understanding.....	do.			5	
——— Divine Analogy.....	do.			6	
Sherlock on Prophecy.....	do.			4	
Revelation Examined with Candour.....	do.	2		8	
Watt's Sermons	do.	2		9	
Logick.....	do.			4	
Philosophical Essays	do.			4	6
Astronomy and Geography	do.			4	
Various Sermons and Tracts.....	do.			6	
World to Come.....	do.			4	6
Lyrick poems	do.			2	6
Misselaneous Thoughts	do.			2	6
	£2 1	5	.5	2	6
<i>Page 3 of Original Record Book.</i>					
Scripture History				2	6
Humble Attempts				2	
On The Passions and Love of God				3	6
Strength and Weakness of Human Reason				2	6
Death and Heaven				1	6
Redeemer and Sanctifier.....				1	6
Guide to Prayer.....				1	6
Spelling Book or Art Reading and Writing.....				1	6
Divine Songs and Prayers for Children.....				1	6
Self-Murder.....				1	6
Catechisms				2	
Hymns.....				2	
Psalms				2	
Holiness of Times, Places and Persons.....				2	
Guise's Sermons and Tracts	2			8	6
On The Holy Spirit				3	6
On The Person of Christ.....				3	6
Handing Use of The Scripture				3	6
Youth's Monitor				1	6
Edwards Preacher.....	£0 15 0	3			
Three Books, Law's Serious Call to a Devout Life.....				7	6
Hurrions, Christ Crucified				4	6
Glorified				5	
On The Spirit				5	
Quincy's Medicina Statira				5	
Hippocrates Aphorisms.....				6	
Cheyn's English Malady				5	
Lobb, on Fevers.....		2		10	
	£0 15 0		4	6	
<i>Page 4 of Original Record Book.</i>					
Robinson, on Consumption				4	6
On The Spleen.....				5	
Cliftons State of Physick				4	
Two Letters on Fevers by Anomalous Authors.....	£0 1 6				
Friends Comentararies on Fevers.....	0 2 0				
Emunolgia	0 3 0				
Lomius, on Fevers.....	0 3 0				
Spectators.....	0 16 0				
Blackmore's Paraphrase on Job	0 2 0				
Milton's Paradise Lost.....	0 2 0				
Regained	0 1 9				
Colman's Incomprehensibleness of God.....	0 1 0				
Moody's Gospel Way of Escaping Ye Doleful State of The Damned.....	0 0 6				
These last two ye Gift of Dr. Colman.					
	£1 13 3	3		13	6

Contemporary Thought in America

"The Press of the Republic is the Moulder of
Public Opinion — the Leader and Educator"

OKLAHOMA

AMERICAN MUNICIPALITIES OF THE FUTURE

BY T. E. STAFFORD

EDITORIAL IN
THE DAILY OKLAHOMAN

The people . . . are giving much attention to the suggestion of municipal government by a commission. . . . By the Houston and Galveston plan of municipal government the mayor and four commissioners are elected at large every four years. They each get the same salary—\$1,200. The mayor devotes six hours a day to the business of the city; the other commissioners give as much of their time as is necessary. One of the advantages of this new system is that, by reason of the commissioners not being required to devote all their time to the work, it is possible to procure the very best business men of the city. In one of the cities which is governed by a commission, the new form of administration is liked so well that there has been no change in six years, except on account of death of one member. He keeps a check on every transaction that is made in the city government every day. Among the chief advantages of the new form of rules is the abolition of retainers and hangers on. Government by commission has been tried not only in Texas, but in all the cities of Europe, and wherever it has been practiced this new system is well liked and considered a great improvement over the old forms. The installation of this kind of government in a city enables the city to be run the same way that business institutions and railways are managed. Unnecessary expenses are eliminated, and a community of interests is fostered and maintained.

MISSISSIPPI

PROGRESS IN ADJUSTING THE RACE PROBLEM

BY FRANK JOHNSTON

EDITORIAL IN
THE JACKSON EVENING NEWS

There is too much discussion of the so-called race problem. . . . In the South there are no race questions whatever that are disturbing the peace and tranquility or the progress and prosperity of the Southern people. There may be some new phases of racial questions in the far future in the South, that may require remedial legislative action, or action by the state authorities, but such is not the case at present. . . . Study the actual conditions of the subject as they exist to-day in the South with an intelligent and temperate scrutiny, and, what those of us who take a calm and correct view of the situation realize to be the situation in the South. And that is an industrious, contented race engaged in the work of improving itself with all its efforts, tilling the soil, and engaged in every branch of industry, living as a race, quiet and contented lives, and as a race, and considering their history, a law-abiding and peace-loving people. With the labor and muscle of these people the South is making rapid strides in progress and prosperity. The South is rapidly growing wealthy, and it is the great laboring class of the South, that is largely composed of negroes, that is working out these magnificent results for the South. Not that the white men of the South are not devoting all of their labor and brains and energies to this great work, but everybody who is informed on the subject knows that by far the greater part of the manual labor that is necessary for the development and rehabilitation of the South is furnished by the negroes. In all this splendid movement of the South in material development, the two races are working together and, as the net result of their mutual efforts, the South will soon be more wealthy and prosperous than at any time in its entire history.

Contemporary Thought in America

ARIZONA

MARRIAGE AND DIVORCE ARE SUBJECT TO EVOLUTION

By J. W. SPEAR

EDITORIAL IN
THE ARIZONA REPUBLICAN

A few people of this country have become unnecessarily excited over . . . the doctrine of trial marriages. The course of marriage and love will not be changed in an instant on the recommendation of any man or woman. What changes there may be will come with changing civilization, which is now making satisfactory forward progress. The subjects of marriage and divorce have not been treated with good sense by those who have agitated them the most loudly, but in the meantime the great mass of the people have been going on getting better all the time, and slowly approaching a proper solution of the relation between men and women. It is an error on one side to regard marriage as a wholly divine institution and divorce as an unpardonable sin, as it is on the other, to regard marriage as the possible result of a passing whim. There is much foolishness on the part of those enthusiasts who are seeking to render divorce in any circumstance difficult almost to the point of impossibility and to prevent by shame and humiliation the separation of those who ought to be separated. "Whom God hath joined together let no man put asunder," is not an injunction laid upon divorce courts.

Marriage is a solemn, but not a sacred institution. . . . Marriage is something more, and something less than a civil contract. People enter into it with a few definite promises and a great many more as clearly understood. Marriage and divorce laws at any stage of the world's history are the product of the best human wisdom and experience prior to that time. That wisdom and experience are more valuable guides to matrimonial well-being than the views of extremist agitators on either side. A trial marriage, necessarily entered upon with doubt, would almost certainly prove a failure.

TENNESSEE

WILL AMERICAN REPUBLIC OUT-GROW STATE LINES

By GILBERT D. PAINE

EDITORIAL IN
THE MEMPHIS NEWS SCIMITAR

The *News Scimitar* has made itself clear as to its attitude on states' rights; and that attitude is that it would not to-day brush down all the state lines or the legal evidences of states' rights; but that the tendency has been, and is and will be, in the direction of gradually effacing these barriers and fortifications; and their final removal will be when they are no longer necessary, which will be when the people of the different sections need have no fear of a lack of reasonable consideration from the people of other sections of the country. . . . We do not agree fully with the president in his first announcement, which he has since explained, on the California Japanese question. This is one of the very matters in which states' rights to-day, as a local safeguard, is still essential. We have faith in the intellectual and spiritual growth of Americans. . . . The states as a whole have always had and are having more from time to time, of influence, moral and legal, on each separate state. The nation, the state, the county and the city always have had, and are having more interference with even a man's relations to his home or his business. The criminal laws and the civil laws fix limits for his conduct in relation to his family, or to his community affected by his business methods. In all relations we are growing more and more our brother's keeper. While the people of California should be allowed to determine the question about Japanese children in the schools, it is also true that there is a radical difference between the Japanese and the negroes. This is admitted and felt in the South. The Honorable John Sharp Williams, the Democratic leader in Congress, and rather of the old school of politics and governmental economy and methods, says, and says properly, that the objection to the negro in the South is not a matter of color, but a matter of race. He says with great force that the negro is half child and half devil. He is yet an infant in intellectual and moral development. He says no community in the South would take offense at seeing a Japanese or even a Chinese at a hotel table. The Japanese are a highly developed and civilized race of people.

Contemporary Thought in America

ILLINOIS

AMERICAN CONSTITUTION IS IN ADVANCE OF TIMES

BY HORATIO W. SEYMOUR

EDITORIAL IN
THE CHICAGO CHRONICLE

There is a regrettable inclination, which seems all the time increasing, to bewail the limitations of the constitution. The president appears greatly impressed with the idea that if he were only unhampered by constitutional restrictions he could be of much greater service to the country. . . . European newspapers are directing attention to it and doing so approvingly. They are explaining that the constitution was framed when the country was in its infancy and that it has been outgrown. This is their diplomatic way of saying that America and its constitution are not worth a cent and that the only way to govern people is by an autocrat and lese majeste laws. This is to be deplored from every point of view. Scripture says "the law is not made for righteous men," and the constitution is not made and is not needed for presidents like Mr. Roosevelt, who are wise and just and above the temptations of corrupt politics. It is made for the salvation of the community when the weak or violent or wicked man gets into the presidency. Its restrictions may at times be an evil, but they are a necessary evil because without them under some administrations liberty would be lost. The constitution is the voice of the people. Its limitations express the people's ideas of what is safe and just. The instrument was not drawn by casting lots or throwing dice. It was the carefully thought-out work of men who died a century ago, but who knew more about political philosophy and about constitution building than all the statesmen of this age put together. The objections made to it are not always worthy of attention. If it did not interfere with the cherished plans of some people it would not be worth a straw. . . . The United States Constitution is far in advance of the American people of the present day and that the crying evil of the twentieth century in the United States is not that the constitution is too narrow but that the people are too lawless and too impatient of wholesome restraint. . . . What the people of this country need is at least one-tenth of the law-abiding instincts of those countries which do not know what liberty is.

MASSACHUSETTS

SHALL AMERICA LIMIT PRIVATE FORTUNES

BY W. H. MERRILL

EDITORIAL IN
THE BOSTON HERALD

A progressive tax on all fortunes beyond a certain amount . . . would not only be just in itself, but would do much to allay the spirit of discontent among the people over the undue privileges and opportunities enjoyed by the rich. . . . If a man has accumulated \$5,000,000 or \$10,000,000, and wishes to "hand it on" to his wife or his son, or to any other person, the government would, by a tax, take all beyond what the law should prescribe as a "healthy limit." . . . Who would take the money thus confiscated, and what would become of it? What guarantee could there be that it would be more wisely disposed of than by the man who made it? The government is not an individual. It is not even a board of trustees for handling bequests and legacies. So far as money is concerned, it is merely a huge machine. . . . Putting quite aside the question of the constitutional warrant for such a law, or of its ethics, the practical consideration remains whether the government would make better use of this surplus wealth for the public good than is now made, in a majority of cases, by the men whose ability, industry and prudence accumulated it? Numerous examples of the beneficent use made of "swollen fortunes" by their possessors are in the public mind. Or, on the business side, how many great enterprises that have wrought wonders for the development of the country and the increase of its prosperity would have been impossible if individual fortunes, after the first generation, had been limited to \$250,000, or even \$1,000,000? If Congress would repeal some of the present taxes on the common necessities of the people, and enact as a revenue measure a reasonable inheritance tax, such as exists in England, and a graded income tax, if it can be lawfully done, the restriction and disposition of fortunes may very well be left to the operation of natural laws and individual judgment.

Contemporary Thought in America

NEW YORK

THE AMERICAN PURPOSE IS COMMON GOOD

EDITORIAL WRITER IN
THE NEW YORK TRIBUNE

This country, this union of states, must have government which serves the welfare of all its members. That would be equally true if it were a compact and centralized nation or if it were the loosest kind of a confederacy. A principal reason for the failure of the old confederacy was that this fact was not sufficiently and practically recognized and that there was too little striving after the common good in the governments of the various states. It was "to promote the general welfare" that the Constitution was ordained. Now it will not do to say that that supreme aim can be defeated by the action, or rather the inaction, of a single state. We can readily imagine what would be the result if some state were, for example, so to neglect the enforcement of sanitary laws as to make itself a plague spot and a menace to the health of its neighbors, or were to regard the criminal code so lightly and to be so lax in police administration as to make itself an asylum for evil-doers. Such conduct on the part of any state would be generally recognized as intolerable. This growth of the nation and the closer interweaving of interstate interests have not only promoted the growth of a spirit of nationality, but also have made necessary the development of those rights and powers of the federal government which were amply provided in the Constitution, but which were not needed and were, therefore, held in abeyance until recent years. National government and state governments alike have rights, but the neglect of duty is not among them. It would be self-stultification to say that the welfare of the people must suffer because the federal government or some state government would not do its duty and could not be compelled to do so. The whole theory of our government is that government exists not for its own arbitrary sake, but for the sake of the people and their welfare. . . . There can be no surer way to maintain the Constitution and to preserve the fine balance between state rights and national sovereignty than for both federal and state governments to be as scrupulous in fulfilling their duties—to the whole Union—as they are vigilant and sensitive in protecting their rights against invasion or impairment.

TEXAS

AMERICA MUST SAVE LIVES OF ITS CHILDREN

EDITORIAL WRITER IN
THE HOUSTON CHRONICLE

It is unfortunately too often the case that the people see where matters in a social and economic sense are going wrong, yet as everybody's business is nobody's business, there is no systematic or organized effort made to set things right until conditions become so bad that the protection of society makes it imperatively necessary that corrective or suppressive action be taken. This is exactly the attitude of the public towards the child labor question. Many saw the evil, many were not brought into contact with it, therefore could not appreciate its magnitude or iniquity, but it is now being pressed upon the public mind and conscience. It is most fortunate that there are to be found some people in this great nation who are both willing and able to give their time and money and influence towards any practical movement for the betterment of social and moral conditions, and a large number of such people are making organized warfare upon the infamous system of child labor. . . . "Child Labor—A National Disgrace—Children Sacrificed to Greed—Girls Are Cheaper Than Cotton." These are fearful headlines, yet they are supported by lamentable and disgraceful statistics. Ten thousand boys from nine to thirteen years old work in coal breakers. Seventy-five hundred children under sixteen years of age work in glass factories. Hundreds of them work all night. Sixty thousand little children under fourteen years of age toil in Southern cotton mills. Little girls eight years old work through a twelve-hour night. Seventy-five per cent of the spinners of North Carolina are only fourteen years old or under. A picture is given of one little boy, now sixteen years of age, who for six years, for beggarly wages, has tied stoppers on bottles in a glass factory, and "his bent shoulders, sunken chest, sallow face and lusterless eyes are the signs of nature's protest against such toil." The pinched faces and shrivelled forms of the children doomed to spend their lives at work in factories show that every hope of future manhood and womanhood is destined to be destroyed, and the state is being robbed of what is or should be its most valuable asset. During the past ten years . . . laws have been passed for the protection of children in Iowa, Maryland, Massachusetts, New York, Missouri, Delaware, Georgia, Rhode Island, Kentucky, Kansas and Pennsylvania.

Contemporary Thought in America

ALABAMA

AMERICA EXTENDS FREEDOM TO ALL RELIGIONS

EDITORIAL IN
THE MONTGOMERY ADVERTISER

The people of these United States will naturally watch with much interest the progress of events in France, and will join the friends of humanity the world over in hoping and praying that there may be no bloodshed. Of all wars that come to plague nations religious wars are the most implacable and deplorable. When men go to war on account of religious difference they seem to lose sight of both religion and humanity and give way to the one desire to win at whatever cost. . . . Among all the principles distinctively marking our government there are two that may be called supreme. One is the absolute religious freedom of all the people. The right to worship God in one's own way, without interference, persecution or hindrance by others, is one of our dearest rights. Even if the peculiar form of one's religious views may be repugnant to others, and may even lead to what others may look on as excesses, we are accustomed to regard it with tolerance, feeling that no one has the right to interfere with the mode of belief or worship of another. . . . Many of the first white settlers on this continent had been driven from their homes by religious intolerance or had fled from religious persecution. They came to America to be free to worship God in their own way, and although in the early days some of the newcomers were intolerant and persecutive, as a general thing those who laid the foundations of a future nation were willing to leave questions of religious belief for each to settle in his own way. When the patriots and statesmen came to write a constitution for the new government that was about to enter on its career, they were careful to insert the words, "Congress shall make no law respecting an establishment of religion, or prohibiting the free exercise thereof," and no feature of our governmental system has been more jealously guarded than that. In all the trials, struggles and wars through which the country has passed absolute freedom of religious worship has been maintained.

PENNSYLVANIA

CONQUEST FOR THE PACIFIC MUST NOT COME

EDITORIAL IN
THE PHILADELPHIA INQUIRER

It has been seriously urged that if Japan, in order to vindicate the right of Japanese youth to attend the public schools of San Francisco without being restricted to the use of any particular establishment, were to go to war with the United States, then England, under the existing treaty, would be obliged to take up arms against us also. . . . Now it is to be said in the first place, that there is not the slightest danger of war occurring between Japan and the United States, either over the troubles in San Francisco or over any other imaginable issue. It is possible, of course, but it is so improbable as not to be worth considering. The Japanese . . . know better than to engage in a conflict from which they would emerge bankrupt and ruined. . . . But assuming the occurrence of what is barely possible, it is difficult to find in the text of the Anglo-Japanese treaty any warrant for the statement that Great Britain, as the result of that treaty, would be dragged into the contest or else forced to repudiate its solemn pledge. . . . The purposes of that treaty are exhibited in the preamble. They are "the consolidation and maintenance of general peace in the regions of eastern Asia and India; the preservation of the common interests of all the powers in China by insuring the independence and integrity of the Chinese Empire and the principle of equal opportunities for the commerce and industry of all nations in China; the maintenance of the territorial rights of the high contracting parties in the regions of eastern Asia and India; and the defense of their special interests." . . . In the second article of the treaty it is provided that "if by reason of an unprovoked attack or aggressive action, wherever arising, on the part of any other power or powers, either contractor be involved in war in defense of its territorial rights or special interests mentioned in the preamble the other contractor shall at once come to the assistance of its ally and conduct war in common and make peace in mutual agreement with it."

The Journal of
American History





2

193

The Journal of
American History

Relating Life Stories of Men and
Events that have entered into the
Building of the Western Continent

REPRODUCTIONS FROM RARE
PRINTS AND WORKS OF ART
(AMERICANA)

Original Researches into Authoritative Sources—American, British and
European Archives—Private Journals, Diaries and Hitherto
Unpublished Documents—Fugitive Papers—
Reminiscences and Memoirs—
Folklore and Traditions

Associated Publishers of American Records

Produced by the Associated Publishers of American Records, Inc.
 in the Ancient Municipality of New Haven, Commonwealth of Con-
 necticut, in Quarterly Art Editions, four books to the volume
 at Two Dollars annually, Fifty Cents a copy & Compiled
 in Collaboration with the Connecticut Magazine
 Protected by copyright and Printed from press
 of the Dorman Lithographing Company
 Publication entered at the Post
 Office at New Haven as mail
 matter of the second class
 Nineteen Hundred
 and Seven



Foreign

Three dollars annually & Seventy-five cents a copy

LONDON	B. F. Stevens & Brown 4 Trafalgar Square, W. C.	ROME	L. Piale 1 Piazza di Spagna
PARIS	Brentano's 37, Avenue de l'Opera	ST. PETERSBURG	Watkins and Company Markala No. 36
BERLIN	Asher and Company Unter den Linden 56	CAIRO	F. Diemer Shepherd's Building
DUBLIN	Combridge and Company 18 Grafton Street	BOMBAY	Thacker and Company Limited Esplanade Road
EDINBURGH	Andrew Elliott 17 Princess Street	TOKIO	Methodist Publishing House 2 Shiohime, Giza Ginza
MADRID	Libreria de Romo y Fassell Calle Alcalá, 5	MEXICO CITY	American Book & Printing Co. 1st San Francisco No. 12

Syllabus of the Ter-Centenary Number

FIRST VOLUME

SECOND NUMBER

Collecting the Various Phases of History, Art, Literature, Science, Industry, and Such as Pertains to the Moral, Intellectual and Political Uplift of the American Nation—Inspiring Nobility of Home and State—Testimonial of the Marked Individuality and Strong Character of the Builders of the American Republic

HERALDIC ILLUMINATION—Coat-of-arms of Captain John Smith, of the first permanent English settlement in America—The three Turks' heads were conferred upon him by Sigismundus Bathor, Duke of Transylvania, for bravery in the Wars of Hungary—Emblazoned in six colors.....By Charles L. N. Camp	
ANCIENT ENGRAVINGS OF EARLY AMERICA—Prints from quaint pictures of the adventures of John Smith from 1597 to 1629 in green tint on imitation parchment	193
AMERICA—THE RISE OF A STRONG PEOPLE—Nine hundredth anniversary of Thorfinn's Discovery of the Western Continent—Four hundredth anniversary of the Christening of the New World as America—Three hundredth anniversary of the Call of the Wilds to the Anglo-Saxons and the daring men who heard.....	
AUTOBIOGRAPHY OF JOHN SMITH—His Own Story of His Birth, Apprenticeship and Youth—Embellished with family arms.....	204
ARMS CONFERRED FOR CHIVALRY—Accurate Translations of Latin Memorials Issued to John Smith for his heroism in the Wars of Hungary in 1603—Embellished with reproductions of the heraldic order.....	205
STRUGGLES OF THE FIRST CITIZENS IN AMERICA—True Record from the time of departure from England in 1606, to the arrival in Virginia in 1607 and the hazardous beginnings of a World Power—From the Journal of William Simons, "doctour of divinitie".....	206
DAWN OF THE NEW WORLD—First Permanent English Settlement in America—Foundation of the people who in three hundred years have stretched over dominions and millions across the continent and whose influence permeates the earth—The Nations of the World extend tribute on this ter-centennial—With ten reproductions of rare engravings and paintings.....Honorable H. St. George Tucker President of the Jamestown Exposition	209
AN OLD ENGLISH PLAY ON AMERICA—The New World in 1607 was the Talk of the Taverns in the Old World and Playwrights Introduced it into their dramas—Extract from "Westward Hoe".....	219
THE FIRST ROMANCE IN AMERICA—The story of the heroism and fortitude of Pocahontas—Her marriage to John Rolfe, the first union of the Western Continent and the Eastern Hemisphere—With six reproductions from rare engravings and paintings.....	221
IN HONOR OF A VALIANT ADVENTURER—Loving lines inscribed to gallant John Smith by Compeers—Ter-centenary statue to be unveiled in September on the scene of the American explorations.....By William Couper, New York City	225
AMERICAN PROGRESS ON THE PACIFIC COAST—Voice of the people as expressed through the Governors of the American Commonwealth to "The Journal of American History".....By Honorable Albert E. Mead Governor of Washington	226
UNTOLD RICHES OF THE ROCKY MOUNTAINS.....By Honorable Frank R. Gooding Governor of Idaho	231
AMERICAN CIVILIZATION IN THE GREATER ANTILLES By Honorable Beekman Winthrop, Governor of Porto Rico	232
RESOURCES OF THE GREAT NORTHWEST.....By Honorable Joseph K. Toole Governor of Montana	234
OPPORTUNITIES IN THE NORTHERN BORDERLAND.....By Honorable E. Y. Sarles Governor of North Dakota	235
COMPULSORY MILITARY TRAINING IN AMERICA—Accurate transcript from original order issued in New England in 1765 and contributed.....By Benjamin C. Lum	230
PUBLIC CARE OF THE POOR IN EARLY AMERICA—Accurate transcript from records of Watertown, Massachusetts.....By M. Augusta Holman Leominster, Massachusetts	233
THE FIRST AMERICAN NOVELIST—Experiences of the first writer in the New World to make literature his sole pursuit and to earn a livelihood by Pen—The first	

INDEX CONTINUED (OVER)

Context with Engravings and Authors

SECOND QUARTER

NINETEEN SEVEN

Chronicles of Those Who Have Done a Good Day's Work—
Rich in Information upon Which May Be Based Accurate
Economic and Sociologic Studies and of Eminent Value to
Private and Public Libraries—Beautified by Reproductions of
Ancient Subjects through the Modern Processes of American Art

CONTINUATION OF INDEX

American Fiction to create a Literary market was "Wieland," the tale of mystery—Career of Charles Brockden Brown—By permission of the author from his Literary History of Philadelphia.....By Ellis Paxson Oberholtzer, Ph.D., University of Pennsylvania	236
BAS-RELIEF OF CHARLES BROCKDEN BROWN, Father of Literary Trade in America.....By Dr. R. Tait McKenzie, Philadelphia, Pennsylvania	240
FIRST PHYSICIANS IN AMERICA—Customs and practices of early Doctors as revealed in correspondence of John Winthrop, born in 1606—Dutch, Quakers and Puritans consulted him regarding their physical ills—The New World is full of his praises—Beginning of American medicine—With eleven transcripts of ancient letters, and reproduction of oil portrait of John Winthrop By Walter R. Steiner, M.A., M.D.	241
THE FIRST STEAMSHIPS TO CROSS THE OCEAN—Recollections of men who participated in first futile attempts to interest capital in the Possibilities of Communication between the Continents by Steam—Opening the Gateways of the World—Historic Voyages—Beginning of Commerce—With transcript of log of the Savannah and twenty-nine rare prints of the development of steam navigation By C. Seymour Bullock	261
TRIALS IN EARLY JUSTICE COURTS IN AMERICA—Court record of Justice Jabez Brainerd, 1773-1775—Serious crimes included "Profane cursing and swairing"—The "Gilty" were sentenced to stock and whipping-post—Debtors frequently bound over to their creditors in servitude—Beginning of American law By Reverend Bert Francis Case	284
THE HOME OF MY CHILDHOOD—Illustrated poem.....By Anna J. Granniss	289
A MAN OF THE SOUTHWEST—Poem.....By John Vance Cheney, Chicago, Illinois	290
TRAVEL IN AMERICA—Excerpt by Roland D. Grant, an American traveler—With four nature illustrations in photo-tone.....	292
ODE TO AMERICA.....By Donald Lines Jacobus	297
WHEN DAYLIGHT DIES—An Evening Pastoral—With four nature illustrations in photo-tone.....By John H. Guernsey, Government Postal Service	299
THE ACADEMY OF AMERICAN IMMORTALS—The Hall of Fame.....	301
Bronze Medallion of Nathaniel Hawthorne—American Novelist.....	302
Bronze Medallion of Washington Irving—An American Litterateur.....	303
Bronze Medallion of Ralph Waldo Emerson—American Philosopher.....	302
Bronze Medallion of Samuel Finley Breese Morse—American Inventor.....	303
EX LIBRIS—American adaptation of the old art of Book Heraldry that originated within half a century of the invention of printing—Reproductions of book plates of William Penn of Pennsylvania and Paul Revere of Massachusetts.....	304
VOYAGES OF AN OLD SEA CAPTAIN—Adventures in South America and in the ports of the Old World during the first years of the American Republic—An American citizen impressed into the British service—His daring escape after years of captivity and conflict—Autobiography.....By Captain Jeremiah Holmes	305
MARRIAGE CONTRACT IN AMERICA IN 1675—Transcribed from original By Mary R. Woodruff	320
TAVERN AND POST ROAD—With three illustrations.....By Norman Talcott	321
HOME LIFE IN OLD AMERICA—Eight reproductions of Ancient Estates in photo-tone.....	325
IN THE FIRST HOMES OF AMERICA—With four exhibitions of antique furniture By Clara Emerson Bickford	328
ANCIENT AMERICAN LANDMARKS—Two illustrations of the first days of American industry.....	331
MODERN AMERICAN SCULPTURE—The "Aztecs".....By Louis A. Gudebrod Member of the National Sculpture Society	332
AN INDIAN LEGEND—"The Flight of Red Bird".....By Joe Cone	333

Transcripts From Ancient Documents

APRIL

MAY

JUNE

The Publishers of "The Journal of American History" wish to acknowledge the thousands of commendatory letters that have been received since the Inaugural Number. Honorable Charles W. Fairbanks, Vice President of the United States, writes: "I congratulate you upon its excellence." The letters include words of appreciation from leading American Scholars and Educators

CONCLUSION OF INDEX

- FIRST PATENT IN AMERICA—Granted in 1646 to the Inventor of "an engine of mills to go by water" and recorded as "Jenkes Mopolye"....By Emeline Jenks Crampton
Lineal Descendant of the Patentee 334
- LIFE ON GREAT AMERICAN PRAIRIES A GENERATION AGO—Two prints from "In the Valley of the Mississippi".....By Wm. H. Milburn 336
- GREAT HEART OF THE AMERICAN DOMINION—Narrative of journey in the wilderness of the Mississippi Valley in 1789-1790—The experiences in the West Region that is gaining control of the American nation and now contains twenty-two of the forty-five United States—Travel in early days of American Republic—With reproductions and prints.....By Major Samuel S. Forman 337
- VOTE TO PROSECUTE NON-CHURCH GOERS IN 1664—.....By S. L. Griffith
of Danby, Vermont 355
- ADVENTURES IN THE AMERICAN NORTHWEST—Life story of a Pioneer Fur Trader and his experiences in the remote parts of the New World—How American business instinct led the way for civilization—Accurate transcript from an almost indecipherable manuscript recently discovered.....By Sir Peter Pond 357
- SONNET—"Oh Ye That Keep the Rule of Modern Town".....By Horace Holley 365
- ESTATE OF A PROSPEROUS AMERICAN IN 1684—"Inventory of Lewis Jones, lately deceased, of goods and chattel taken by us whose names are now written this twentieth day of April, 1684"—Transcript from original.....By Walter E. Jones
of Waitsfield, Vermont, a descendant of the legator 366
- FIRST SILHOUETTISTS IN AMERICA—Earliest extant type of Pictorology—Brown's notable collection of portraits of distinguished Americans—With reproductions from Original Silhouettes of Daniel Webster of Massachusetts, Andrew Jackson of South Carolina, John Randolph of Virginia, Bishop William White of Pennsylvania.....By Howard Marshall 367
- WILL OF MARY WASHINGTON IN 1788—Mother of the first President of the United States—Transcribed from Clerk's office at Fredericksburg, Virginia
By Mrs. Helen Cook Porter of Baltimore, Maryland 372
- LIFE STORIES OF GALLANT AMERICANS—John Thomas—Colonel of Spartanburg and Jane Thomas' Famous Ride.....By Mrs. Robert J. Herndon 373
- DAVID NOBLE—PATRIOT OF PITTSFIELD—He gave his wealth and then his life to the cause of American Independence.....By Mrs. Sara B. Francis
Philadelphia, Pennsylvania 376
- PHINEAS SLAYTON—The Venerable Volunteer—He Fought in the American Revolution and had to be "Coaxed to go home" in the War of 1812—Anecdote contributed
By Carrie J. Doane of Arlington, Iowa 378
- CONTEMPORARY THOUGHT IN AMERICA—"The Press of the Republic is the Moulder of Public Opinion—the Leader and Educator".....
Must American Prosperity be Retarded.....By John P. Young
In San Francisco (California) "Chronicle" 379
- Are These America's Needs?—A Great Problem.....By George W. Norton
In Portland (Maine) "Evening Express" 379
- Omens of the Fiercest Conflict Known to History—
In Louisville (Kentucky) "Herald" 380
- North and South are United Forever
In Richmond (Virginia) "Times-Dispatch" 380
- Human Brotherhood—Hands Across the Sea
In Charleston (South Carolina) "News and Courier" 381
- Man's Ambition—Quest of the North Pole
In Washington (District of Columbia) "Post" 381
- LAST LEAF—EDITORIAL COMMENT
- PRIVATE LETTER WRITTEN BY GEORGE WASHINGTON, Father of the American Republic, to an intimate friend in which he warns against impending dangers...Cover

Copyrighted by Associated Publishers of American Records, 671-679 Chapel Street, New Haven, Connecticut



*These are the Lines that shew thy Face; but those
 That shew thy Grace and Glory brighter bee:
 Thy Faire Discoveries and Fowle - Overthrowes
 Of Salvages, much Civilliz'd by thee
 Best shew thy Spirit; and to it Glory Wynn
 So, thou art Brasse without, but Golde within
 (If so; in Brasse too soft smiths Acts to beare.)
 I see thy Fame, to make Brasce Steele out weare.
 Thine, as thou art Vertues.
 John Davies, Poet.*

AMERICA'S KNIGHT ERRANT
 Rare Engravings
 from the Originals in
 The True Travels, Adventures and Observations
 of Captaine John Smith
 in
 Europe, Asia, Africke, and America
 Beginning
 About the Yeere 1599, and Published in 1624

John Smith's acceptance of the challenge of a Native warrior
 to "regaine his friends head, or lose his own" in which he
 gallantly took the head horse and armour of his combatant and
 graciously sent "his body and his rich apparell" back to the

200



AMERICA'S KNIGHT ERRANT

Rare Narratives
 from the Originals in
 The True Travels, Adventures and Observations
 of Captain John Smith
 in
 Europe, Asia, Africa, and America
 Beginning
 About the Year 1607, and Published in 1820



of the ... hundredth Anniversary
 The Adventures of John Smith in the War of the Turkes and the Christians in which, by signal torches from the hill, he kept in communication with the Army at seven miles distance and by his stratagem drove back twenty thousand Turkes in confusion

His Combat with GRVALGO Cap: of three hundred horsemen



John Smith's acceptance of the challenge of a Turkish warrior to "regain his friend's head, or lose his owne," in which he promptly took the head, horse and armour of his combatant and graciously sent "his body and his rich apparel back to Town"



The Adventures of John Smith in the War of the Turkes and the Christians in which by signal torches from the hill he kept in communication with the Army at seven miles distance and by his stratagem drove back twenty thousand Turkes in confusion



John Smith's acceptance of the challenge of a Turkish warrior to "regain his friends head, or lose his own", in which he promptly took the head, horse and armour of his combatant and graciously sent "his body and his rich apparel back to Town"

The Journal of American History



VOLUME I
NINETEEN SEVEN

EDITED BY FRANCIS TREVELYAN MILLER

NUMBER II
SECOND QUARTER

America—Rise of a Strong People

Nine Hundredth Anniversary of Thorfinn's Discovery of the Western Continent & Four Hundredth Anniversary of the Christening of the New World as "America" & Three Hundredth Anniversary of the Call of the Wilds to the Anglo-Saxons and the Daring Men who Heard

THE American people to-day stand at the threshold of a new chronological epoch. Time has marked its footsteps and is now balancing the accounts of finished centuries. Marvelous as has been the sweep of progress across the Western Continent, the work of civilization is to-day but in its beginning. The uncovered wealth of the wilderness is but the intimation of the possibilities of the coming epoch. Many of the powerful nations of the earth could be devoured in the virgin forests that are yet unmeasured and unmarked by the trails of men and whose secrets the white race is yet to learn.

From Panama to the Arctic runs a wild confusion of mountains like a caravan that never passes by, whose camel backs are laden with the sky—thousands of miles north and south,

until the awful range plunges beneath the sea in the Aleutian Islands—that can never be touched in survey by half a dozen generations, and the blessed Alps of Europe could be hopelessly lost in its legions of peaks.

The new epoch must reveal wonders that to-day are not even dreams. The next century of American progress is beyond the comprehension of finite mind.

Ambassador Porter recently said: "If we may judge the future progress of this land by its progress in the past, it does not require that one should be endowed with prophetic vision to predict that this young but giant Republic will dominate the policy of the world. Woven of the stoutest fibers of other lands, nurtured by a commingling of the best bloods of other races, her manifest destiny is to light the torch of liberty till it illumines the entire pathway of the earth."

Call of the Wilds and the Men Who Heard

THIS is the nine hundredth anniversary of the traditional discovery of America. It was in the year 1007, according to the Sagas, that Thorfinn, after having sailed from Norway to Greenland, on the previous year, came to Vinland with three ships and one hundred and sixty persons, sighted New Foundland and Nova Scotia, sailed along the New England coast and landed upon an island where they spent the winter. For three years these adventurers are said to have lingered on the Western Continent, spending most of the time in a bay, which has been identified with Mount Hope Bay, and trading with the Esquimaux. The Norwegians returned to the Old World in 1011, and Thorfinn died about 1016, leaving no record that shows that his journeys were in the interests of discovery but rather as trading expeditions. Whatever may be the truth of the Sagas, the New World remained in darkness until the coming of Columbus four hundred and eighty-five years later. It was he who opened the gateway and started the stream of immigration that is to-day continuing in its ceaseless flow of more than a million adventurers each year.

THIS is the four hundredth anniversary of the naming of America. Five years after Columbus proclaimed to the Eastern Continent that in the far West there was a New World the vastness of which he dare not intimate, one Americus Vespucci came to the mainland and on his return to the Old World recorded his claims as a discoverer, soliciting the services of the geographers to the extent that in 1507 a little publication entitled "Cosmopgraphiæ Introductio," edited and issued by two scholars, Waldseemuller and Ringmann, at the college of St. Die in the Vosges coun-

try, spoke of the mysterious land as "America." It is said that Ringmann was an ardent admirer of Vespucci and his quick wit applied the name as mark of honor to him. The friends of Columbus gave little heed to the naming of the New World. Its rich possibilities were their only concern. "America" was occasionally repeated until it finally appeared on Schoner's globe in 1515 and was adopted by a map maker in 1517. From this the name gained general circulation and it was soon fastened so firmly on the minds of the people that not even the friends of Columbus could overcome it. The matter of justice came too late, and Columbus forever lost the distinction that was justly earned by him. It is one of the instances that are so very common even to-day where the lust for gold blinds the seeker from greater honors.

It is just four hundred years ago that Alvar Nunez Cabeza de Vaca, the Spanish explorer who accompanied Narvaez to Florida, was born. This gallant cavalier at twenty years of age came to the New World and faced its dangers in a daring march along the southern borders. He was wrecked near Matagoria Bay in Texas and captured by the Indians. He gained their confidence by becoming a medicine man in their tribe and finally escaped, and after experiences the like of which few men have ever known, de Vaca reached Mexico, discovering the Rio Grande during his wanderings. He later turned his attention to the far South and was the first explorer of Paraguay, dying at the age of fifty-two years.

This is the three hundredth anniversary of the arrival of Poutrincourt in Nova Scotia. Two years before, Sieur De Monts had founded Port Royal in Acadia, now Annapolis, under many difficulties, and only by the arrival of Poutrincourt was the settlement made permanent. Seven years later, Samuel Argall of Virginia went to Acadia on an expedition and ravaged the French colony.

Three TVRK'S heads in a banner given him for Armes :-



How he was presented to Prince SIGISMUNDVS, Chap. 8.

John Smith, with a guard of six thousand, three spare horses, before each "a Turkes head upon a lance," returning from his triumphs with two thousand prisoners, to the Prince's Palace where the "three Turkes heads" are emblazoned on his shield

Capt' SMITH: led Captive to the BASHAW of NALBRITS in TARTARIA



John Smith, wounded in battle, taken prisoner and sold in the slave-market to a noble Gentlewoman in Constantinople, whose affection for him so angered her brother that he stripped him of clothes and shaved his head—Smith killed his master and fled



John Smith with a guard of six thousand three spare horses before each a Turk's head upon a lance, returning from his triumphs with two thousand prisoners to the Prince's Palace where the Turk's heads, are emblazoned on his shield.



John Smith, wounded in battle, taken prisoner and sold in the slave-market to a noble Gentlewoman in Constantinople, whose affection for him so angered her brother that he stripped him of clothes and shaved his head—Smith killed his master and fled.



In three hundredth anniversary of the first establishment of the planting of the flag of the English-speaking people on the coast of Maine. In 1607, two ships the "Mary and John" commanded by George Popham, and the "Swarth God" commanded by Raleigh Gilbert were sent out with one hundred men from England and reached the mouth of the Kennebec river in Maine on August the nineteenth, founding the settlement of Popham. Captain John Smith held a prisoner by the American Aborigines left to the severe winter, Popham died and on the arrival of a ship with pro-

... and ...
 Here the ...
 Here was ...
 Here did ...
 Honor we our nation's ...

2024



Captain John Smith held a prisoner by the American Aborigines
 in 1675 and related into the sacred presence of the Holy Idol
 while the Priest and the Conjuror were about him and
 subdued him with their weird incantations and hideous outcries

Blazing the Path for Earth's Civilization

Fourteen years from this, Acadia was captured by the English, and four years later restored to the French, only to be again captured in 1690, re-taken in 1691, and finally made an English stronghold in 1710. It is on this scene that Longfellow set his beautiful classic "Evangeline."

THIS is the three hundredth anniversary of Hendrick Hudson's exploration of the coast of Greenland and his discovery of the existence of an open polar sea. In 1607, under the Muscovy Company, he started in search of a northwest passage. A year later he made a second voyage and on the following year, under the Dutch East India Company, he coasted along Labrador to the southward, touching at New Foundland, Penobscot Bay, Cape Cod and the Chesapeake. On this expedition he sailed up the Hudson river as far as Albany. It is still one year later that he entered the strait and bay which bear his name. On this voyage his crew became mutinous because of severe hardships and set Hudson adrift in a small boat. Nothing was ever heard from him or his seven companions and his terrible sufferings and tragic end can only be surmised.

It is the three hundredth anniversary of the first establishment of the planting of the flag of the English-speaking people on the coast of Maine. In 1607, two ships, the "Mary and John" commanded by George Popham, and the "Gift of God" commanded by Raleigh Gilbert, were sent out with one hundred men from England and reached the mouth of the Kennebec river in Maine on August the nineteenth, founding the settlement on the northern Atlantic coast at Fort George. Popham was left to establish a colony at Sabino, and Gilbert returned home. During the severe winter, Popham died and on the arrival of a ship with pro-

visions the next year the colonists who had survived were willing to abandon the colony.

It is the three hundredth anniversary of the movement that sent the Pilgrims to Plymouth Rock a few years later. It was in 1607 that the first Separatists from Northern England went into Holland, seeking religious liberty. On the following years many of their friends followed them until the movement to America began and in 1620 the "Mayflower" came to the New England coast. This seems to have been an age of expansion. The call of the American wilds echoed through the Old World. Strong men answered it. The ocean swept them to the jungle shores. The forests moaned before their power and fell at their feet. Wild beast and wild man were driven back before the steel of civilization. Log cabins, villages, towns, cities, rose from the wilderness—a hundred, a thousand, millions of men and women lifted their towers of civilization until to-day they pierce the skies and their domes reflect the light of the sun to the New Comers from the Old World long before their feet have felt the soil of the Republic that three hundred years ago was establishing its first English-speaking settlement at Jamestown, Virginia, and is to-day a World Power.

Here was human freedom planted
In the region of the West;
Here the torch of Truth was lighted,
Typifying all that's best.
Here was suffered strong men's anguish,
Here did heroes do and die.
Honor we this soil as sacred,
Honor we nobility.
'Mid the serried ranks of nations,
'Mid the navies of the earth,
With a pride both just and noble,
Honor we our nation's birth.



Autobiography of John Smith

Recorded by Him in His Owne Adventures and Observations in
1629 & Relating His Birth, in 1579, Apprenticeship and Youth

HE was borne in *Willoughby* in *Lincolne-shire*, and a Scholler in the two Free-schools of *Alford* and *Louth*. His father anciently descended from the ancient *Smiths* of *Crudley* in *Lancashire*; his mother from the *Rickands* at great *Heck* in *York-shire*. His parents dying when he was about thirteene yeeres of age, left him a competent means, which hee not being capable to manage, little regarded; his minde being even then set upon brave adventures, sould his *Satchell*, bookes, and all he had, intending secretly to get to *Sea*, but that his fathers death stayed him. But now the Guardians of his estate more regarding it than him, he had libertie enough, though no meanes, to get beyond the *Sea*. About the age of fiftene yeeres hee was bound an Apprentice to *Mr. Thomas Sendall* of *Linne*, the greatest Merchant of all those parts; but because hee would not presently send him to *Sea*, he never saw his master in eight yeeres after. At last he found meanes to attend *Mr. Perigrine Barty* into *France*, second sonne to the Right Honourable *Perigrine*, that generous Lord *Willoughby*, and famous Souldier; where comming to his brother *Robert*, then at *Orleans*, now Earle of *Linsey*, and Lord great Chamberlaine of *England*; being then but little youths under Tutorage: his service being needlesse, within a moneth or six weeke they sent him backe againe to his friends; who when he came from *London* they liberally gave him (but out of his owne estate) ten shillings to be rid of him; such oft is the share of fatherlesse children, but those two Honourable Brethren gave him sufficient to returne for *England*. But, it was the least thought of his determination, for now being freely at libertie in *Paris*, growing acquainted with one Master *David Hume*, who making some use of his purse, gave him Letters to his friends in *Scotland* to preferre him to King *James*. Arriving at *Roane*, he better bethinkes himselfe, seeing his money neere spent, downe the *River* he went to *Haver de grace*, where he first began to learne the life of a souldier: Peace being concluded in *France*, he went with Capitaine *Ioseph Duxbury* into the Low-countries, under whose Colours having served three or foure yeeres, he tooke his journey for *Scotland*, to deliver his Letters. At *Ancusan* he embarked himselfe for *Leithe*, but as much danger, as ship-wrackle and sicknesse could endure, hee had at the holy Ile in *Northumberland* neere *Barwicke*: (being recovered) into *Scotland* he went to deliver his Letters. After much kinde usage amongst those honest *Scots* at *Ripweth* and *Broxmoth*, but neither money nor meanes to make him a Courtier, he returned to *Willoughby* in *Lincoln-shire*; where within a short time being glutted with too much company, wherein he took small delight, he retired himselfe into a little wooddie pasture, a good way from any towne, invironed with many hundred Acres of other woods: Here by a faire brook he built a Pavillion of boughes, where only in his cloaths he lay. His studie was *Machiavills* Art of warre, and *Marcus Aurelius*; his exercise a good horse, with his lance and Ring; his food was thought to be more of venison than any thing else; what he wanted his man brought him. The countrey wondering at such an Hermit; His friends perswaded one *Seignior Theadora Polaloga*, Rider to *Henry Earle of Lincolne*, an excellent Horse-man, and a noble *Italian* Gentleman, to insinuate into his wooddish acquaintances, whose Languages and good discourse, and exercise of riding drew him to stay with him at *Tattersall*. Long these pleasures could not content him, but hee returned againe to the Low-Countryes. Thus when *France* and *Netherlands* had taught him to ride a Horse and use his Armes, with such rudiments of warre, as his tender yeeres in those martiall Schooles could attaine unto; he was desirous to see more of the world, and trie his fortune.



Arms Conferred for Chivalry

Translations from the Original Latin Memorials Issued to John Smith and Recorded in His Narrative of the Wars of the East in 1603

SIGISMVNDVS BATHOR, by the Grace of God, Duke of *Transilvania, Wallachia, and Moldavia*, Earle of *Anchard, Salford and Growenda*; to whom this Writing may come or appeare. Know that We have given leave and licence to *John Smith* an *English Gentleman*, Captaine of 250. Souldiers, under the most Generous and Honourable *Henry Volda*, Earle of *Meldritch, Salmaria, and Peldoia*, Colonell of a thousand horse, and fiteene hundred foot, in the warres of *Hungary*, and in the Provinces aforesaid under our authority; whose service doth deserve all praise and perpetuall memory towards us, as a man that did for God and his Country overcome his enemies: Wherefore out of Our love and favour, according to the law of Armes, We have ordained and given him in his shield of Armes, the figure and description of three *Turks* heads, which with his sword before the towne of *Regall*, in single combat he did overcome, kill, and cut off, in the Province of *Transilvania*. But fortune, as she is very variable, so it chanced and happened to him in the province of *Wallachia*, in the yeare of our Lord, 1602. the 18. day of November, with many others, as well Noble men, as also divers other Souldiers, were taken prisoners by the Lord *Bashaw* of *Cambia*, a Country of *Tartaria*; whose cruelty brought him such good fortune, by the helpe and power of Almighty God, that hee delivered himselfe, and returned againe to his company and fellow souldiers, of whom We doe discharge him, and this hee hath in witness thereof, being much more worthy of a better reward; and now intends to returne to his owne sweet Country. We desire therefore all our loving and kinde kinsmen, Dukes, Princes, Earles, Barons, Governours of Townes, Cities, or Ships, in this Kingdome, or any other Provinces he shall come in, that you freely let passe this the aforesaid Captaine, without any hinderance or molestation, and this doing, with all kindnesse we are always ready to doe the like for you. Sealed at *Lipswick* in *Misenland*, the ninth of December, in the yeare of our Lord, 1603.

SIGISMVNDVS BATHOR.

With the proper privilege of his Majestic.

To all and singular, in what place, state, degree, order, or condition whatsoever, to whom this present writing shall come: I *William Segar* Knight, otherwise Garter, and principall King of Armes of *England*, wish health. Know that I the aforesaid Garter, do witness and approve, that this aforesaid Patent, I have seene, signed, and sealed, under the proper hand and Seale Maunal of the said Duke of *Transilvania*, and a true copy of the same, as a thing for perpetuall memory, I have subscribed and recorded in the Register and office of the Heralds of Armes. Dated at London the nineteenth day of August, in the yeare of our Lord, 1625. and in the first yeare of our Soueraigne Lord *Charles* by the grace of God, King of great *Britaine, France, and Ireland*; Defender of the faith, &c.

WILLIAM SEGAR.

Experiences on Journey to America

Accurate Transcript from the Booke of Proceedings and
Accidents of the First Permauent English Settlement in America

BY WILLIAM SIMONS

“DOCTOUR OF DIVINITIE”

ON the 19 of December, 1606. we set sayle from Blackwall, but by vnprosperous winds were kept six weekes in the sight of *England*; all which time, Mr *Hunt* our Preacher, was so weake and sicke, that few expected his recovery.—Yet although he were but twentie myles from his habitation (the time we were in the Downes) and notwithstanding the stormy weather, nor the scandalous imputations (of some few, little better then Atheists, of the greatest ranke amongst vs) suggested against him, all this could never force from him so much as a seeming desire to leaue the business, but preferred the service of God, in so good a voyage, before any affection to contest with his godlesse foes, whose disasterous designes (could they haue prevailed) had even then overthrowne the businesse, so many discontented did then arise, had he not with the water of patience, and his godly exhortations (but chiefly by his true devoted examples) quenched those flames of envie, and dissention.

We watered at the Canaries, we traded with the Salvages at *Dominica*; three weekes we spent in refreshing our selues amongst these west-India Isles; in *Gwardalupa* we found a bath so hot, as in it we boyled Porck as well as over the fire. And at a little Isle called *Monica*, we tooke from the bushes with our hands, neare two hogshheads full of Birds in three or foure houres. In *Mevis*, *Mona*, and the Virgin Isles, we spent some time, where, with a lothsome beast like a Crocodil, called a Gwayn, Tortoises, Pellicans, Parrots, and fishes, we daily feasted. Gone from thence in search of *Virginia*, the company was not a little discomforted, seeing the Marriners had 3 dayes passed their reckoning and found no land, so that Captaine *Ratliffe* (Captaine of the Pinnace) rather desired to beare vp the helme to returne for *England*, then make further search. But God the guider of all good actions, forcing them by an extreame storme to hull all night, did driue them by his providence to their desired Port, beyond all their expectations, for never any of them had seene that coast. The first land they made they called *Cape Henry*; where thirtie of them recreating themselves on shore, were assaulted by fve Salvages, who hurt two of the English very dangerously. That night was the box opened, and the orders read, in which *Bartholomew Gosnoll*, *John Smith*, *Edward Wingfield*, *Christopher Newport*, *John Ratcliffe*, *John Martin*, and *George Kendall*, were named to be the Councill, and to choose a President amongst them for a yeare, who with the Councill should governe. Matters of moment were to be examined by a Iury, but determined by the maior part of the Councill, in which the President had two voyces. Vntill the 13 of May they sought a place to plant in, then the Councill was sworne, Mr *Wingfield* was chosen President, and an Oration made, why Captaine *Smith* was not admitted of the Councill as the rest.

Now falleth every man to worke, the Councill contriue the Fort, the rest cut downe trees to make place to pitch their Tents; some provide clabbord to relade the ships, some make gardens, some nets, &c. The Salvages often visited vs kindly. The Presidents overweening jealousie would admit no exercise at armes, or fortification, but the boughs of trees cast together in the forme of



POWHATAN

*Held this state & fashion when Capt. Smith
was delivered to him prisoner
1607*



*King Powhatan commands Smith to be slayed, his
daughter Pocahontas begs his life his thankfulness
and here he subjected 29 of their Kings made his history*

the
English
appreciate
reason

Captain John Smith is an attorney to solve the
**Captain John Smith condemned to death by the Aborigines of the
 New World—Quaint scene of his sentence and his tragic rescue
 by the daughter of the Savage King at the moment of execution—
 Reproduced from Rare Engravings from Captain Smith's Adventures**

Experiences

America

Accurate Description of the Indians of Virginia and
Accidents of the Voyage to America

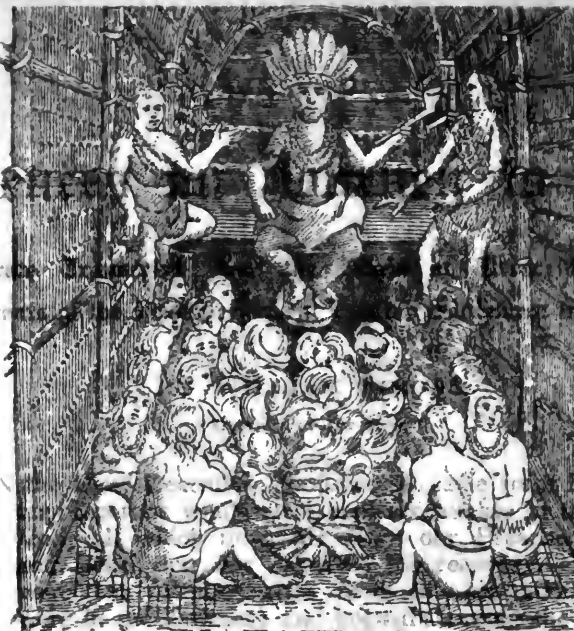

NATAHPOW

Archeists, of the ... could never ... but preferred ... to come ... prevent ... then ... (but ... disson ...

three ... in ... the fir ... hands ...

the fir ... hands ...



the first ... which ... Newport ... the Co ... lury, but ... had two ... the Co ... made, why Captaine Smith was not admitted of the Councell as the rest. Now ... the rest cut down ... lapbord often visited ... No exercise at armes, or fortification, but the boughs of trees cast together in the forme of

Struggles of First Citizens in America

a halfe moone by the extraordinary paines and deligence of Captaine Newport, Smith, and twentie others, were sent to discover the river
 Towne, a hill is verie high, and what
 with the reason of the Rocks
 small beinge returned with
 them beinge returned with
 cause at the where
 the S down had a

Or in
 and
 were
 escap
 adaye
 the s
 refer
 Capta
 with
 from
 of some of the
 the gov
 feder
 ats th
 thirt
 retur
 cell
 make
 repa
 after
 the s
 at d



Smith taketh the King of Pamunkey prisoner. - 1608.

were charged against him; but being so apparently deposed, he got a general
 favour of the company against such a day: Christianized, and the
 Doctrine - as admitted to give him 2000. s that all he had was second year
 part of same sum, which Smith presently returned to the Store for the
 use of the Company. Many were the mischiefs that daily sprung from their
 ignorant (yet ambitious) spirits; but the good Doctrine and exhortation of the
 Preacher Mr Hunt reconciled them, and caused Captaine Smith to be admitted
 of the Councell; the next day all received the Communion, the day following
 the Salvages voluntarily desired peace, and Captaine Newport returned to
 England with newes; leaving in Virginia 1000 the 15 of June 1607.

Being thus left to our fortunes, it fortun'd that within ten dayes scarse ten
 amongst vs could either see, or well stand, such extreame weaknes and sickness
 oppressed vs, that we were forced to take up our abode in the fort, and
 reason, which was, that the King of Pamunkey, havinge snatched the King by his long locks and with
 his Pistol ready beat against his breast, led him trembling
 neare dead with feare" and addressed the terrified aborigines



Portrait of the King of Tomawac before 1808

Captain John Smith in an attempt to force the American Savages
 the Indians, attacked the King by his long lance and with
 the Flint, which he aimed against the breast of his tormenting
 some head with force and he was killed, the terrified savages
 fled in confusion, leaving the King's body on the ground.

Struggles of First Citizens in America

a halfe moone by the extraordinary paines and deligence of Captaine *Kendall*, *Newport*, *Smith*, and twentie others, were sent to discover the head of the river: by divers small habitations they passed, in six dayes they arrived at a Towne called *Powhatan*, consisting of some twelue houses, pleasantly seated on a hill; before it three fertile Isles, about it many of their cornefields, the place is very pleasant, and strong by nature, of this place the Prince is called *Powhatan*, and his people *Powhatans*, to this place the river is navigable: but higher within a myle, by reason of the Rockes and Isles, there is not passage for a small Boat, this they call the Falles, the people in all parts kindly intreated them, till being returned within twentie myles of *Iames* towne, they gaue iust cause of ieachousie, but had God not blessed the discoveries otherwise then those at the Fort, there had then beene an end of that plantation; for at the Fort, where they arrived the next day, they found 17 men hurt, and a boy slaine by the Salvages, and had it not chanced a crosse barre shot from the Ships strooke downe a bough from a tree amongst them, that caused them to retire, our men had all beene slaine, being securely all at worke, and their armes in dry fats.

Herevpon the President was contented the Fort should be pallsadoed, the Ordnance mounted, his men armed and exercised, for many were the assaults, and ambuscades of the Salvages, and our men by their disorderly stragling were often hurt, when the Salvages, by the nimblenesse of their heeles well escaped. What toyle we had, with so small a power to guard our workemen adayes, watch all night, resist our enemies, and effect our businesse, to relade the ships, cut downe trees, and prepare the ground to plant our Corne, &c, I referre to the Readers consideration. Six weekes being spent in this manner, Captaine *Newport* (who was hired onely for our transportation) was to returne with the ships. Now Captaine *Smith*, who all this time from their departure from the Canariets was retained as a prisoner vpon the scandalous suggestions of some of the chiefe (envying his repute) who fained he intended to vsurpe the government, murther the Councill, and make himselfe King, that his confederates were dispersed in all the three ships, and that divers of his confederats that revealed it, would affirme it, for this he was committed as a prisoner: thirteene weekes he remained thus suspected, and by that time the ships should returne they pretended out of their commisserations, to referre him to the Councill in *England* to recciue a check, rather then by particulating his designes make him so odious to the world, as to touch his life, or vtterly overthrow his reputation. But he so much scorned their charitie, and publicly defied the vttermst of their crueltie, he wisely prevented their policies, though he could not suppress their envies, yet so well he demeaned himselfe in this businesse, as all the company did see his innocency, and his adversaries malice, and those suborned to accuse him, accused his accusers of subornation; many vntruthes were alledged against him; but being so apparently disproved, begat a generall hatred in the hearts of the company against such vniust Commanders, that the President was adiudged to giue him 200*l*. s that all he had was seized vpon, in part of satisfaction, which *Smith* presently returned to the Store for the generall vse of the *Colony*. Many were the mischiefes that daily sprung from their ignorant (yet ambitious) spirits; but the good Doctrine and exhortation of our Preacher Mr *Hunt* reconciled them, and caused Captaine *Smith* to be admitted of the Councill; the next day all receiued the Communion, the day following the Salvages voluntarily desired peace, and Captaine *Newport* returned for *England* with newes; leaving in *Virginia* 100. the 15 of Iune 1607.

Being thus left to our fortunes, it fortunated that within ten dayes scarce ten amongst vs could either goe, or well stand, such extreame weaknes and sicknes oppressed vs. And thereat none need marvaile, if they consider the cause and reason, which was this; whilst the ships stayed, our allowance was somewhat

Hazardous Beginning of a World Power

bettered, by a daily proportion of Bisket, which the sailers would pilfer to sell, giue, or exchange with vs, for money, Saxefras, fures, or loue. But when they departed, there remained neither taberne, beere-house, nor place of reliefe, but the common Kettell. Had we beene as free from all sinnes as gluttony, and drunkennesse, we might haue beene canonized for Saints; But our President would never haue beene admitted, for ingrossing to his private, Oatmeale, Sacke, Oyle, *Aquavita*, Beefe, Egges, or what not, but the Kettell; that indeed he allowed equally to be distributed, and that was halfe a pint of wheat, and as much barley boyled with water for a man a day, and this having fryed some 26. weekes in the ships hold, contained as many wormes as graines; so that we might truly call it rather so much bran then corne, our drinke was water, our lodgings Castles in the ayre: with this lodging and dyet, our extreame toile in bearing and planting Pallisadoes, so strained and bruised vs, and our continual labour in the extremitie of the heat had so weakened vs, as were cause sufficient to haue made vs miserable in our natiue Countrey, or any other place in the world. From May, to September, those that escaped, liued vpon Sturgeon and Sea-crabs, fittie in this time we buried, the rest seeing the Presidents projects to escape these miseries in our Pinnace by flight (who all this time had neither felt want nor sicknes) so moved our dead spirits, as we deposed him; and established *Ratcliffe* in his place, (*Gosnoll* being dead) *Kendall* deposed, *Smith* newly recovered, *Martin* and *Ratcliffe* was by his care preserved and relieued, and the most of the souldiers recovered, with the skilfull diligence of Mr. *Thomas Wetton* our Chirurgian generall. But now was all our provision spent, the Sturgeon gone, all helps abandoned, each houre expecting the fury of the Salvages; when God the patron of all good indeuours, in that desperate extremitie so changed the heart of the Salvages, that they brought such plenty of their fruits, and provision, as no man wanted.

And now where some affirmed it was ill done of the Councell to send forth men so badly provided, this incontradictable reason will shew them plainly they are too ill advised to nourish such ill conceits; first, the fault of our going was our owne, what could be thought fitting or necessary we had, but what we should find, or want, or where we should be, we were all ignorant, and supposing to make our passage in two moneths, with victuall to liue, and the advantage of the spring to worke; we were at Sea fiew moneths, where we both spent our victuall and lost the opportunitie of the time, and season to plant, by the vnskilfull presumption of our ignorant transporters, that vnderstood not at all, what they vndertooke.

Such actions haue ever since the worlds beginning beene subject to such accidents, and every thing of worth is found full of difficulties, but nothing so difficult as to establish a Common wealth so farre remote from men and meanes.

By this obserue;

Good men did ne'er their Countries ruine bring.
But when euill men shall iniuries beginne;
Not caring to corrupt and violate
The iudgments-seats for their owne Lucr's sake:
Then looke that Country cannot long haue peace,
Though for the present it haue rest and ease.



208a
R. 1.
Captain John Smith taken captive by the Savages and bound to a tree to be shot to death while his executioners triumphantly danced about him, swinging their bows and arrows and subjecting him to torture—Specimen of ancient engraving in Smith's book

Hazardous Beginning of a World Power



Such actions have ever since the worlds beginning beene subject to such accidents, and every thing of worth is found full of difficulties, but nothing so difficult as to establish a Common wealth so farre remote from men and meanes

By this obserue;

Good men did ne'er their Countries come to
 But when euill men shall injuries beginne
 Not caring to corrupt and violate
 The iudgments seeke for their own Lutes sake

Then looke that
 Captaine John Smith taken captiue by the Swedes and bound to a tree to be shot to death while his executioners triumphantly danced about him, swinging their bows and arrows and subjecting him to torture—Specimen of ancient engraving in Smith's book

108



How they took him prisoner in the year 1609.

Smith bindeth a savage who had been with the King of Paspagueh and all his company, and slays of them.

C. Smith takes the King of Paspagueh prisoner A^o 1609.

First English Founders Years h Across Earth

RECORDS OF THE

MEMORIAL OF THE



ON this...
 the...
 English...
 America...
 pressed...
 before...
 of my friend

ernor Henry A. Wise, the
 ant Virgin Rare Engravings of the Adventures of Captain John Smith, his
 Jamestown, daring escapades with the Native Americans, his captures and
 Here the odious first dangers and his triumphs in establishing the shores of
 Here the w First Permanent English Settlement on the Western Hemisphere Pacific now



Rare Engravings of the Adventures of Captain John Smith, his daring escapades with the Native Americans, his captures and escapes, his dangers and his triumphs in establishing the first Permanent English Settlement on the Western Hemisphere.

1000

The Dawn of the New World



First Permanent
English Settlement in America *
Foundation of a People who in Three Hundred
Years have Stretched their Dominion and Millions
Across the Continent and whose Influence Permeates the
Earth * Nations of the World Extend Tribute on this Ter-Centennial

BY

HONORABLE H. ST. GEORGE TUCKER

PRESIDENT OF THE JAMESTOWN EXPOSITION—DEAN OF THE SCHOOL OF POLITICS AND DIPLOMACY AT GEORGE WASHINGTON UNIVERSITY, WASHINGTON, D. C.—FORMER DEAN OF WASHINGTON AND LEE UNIVERSITY AT LEXINGTON, VIRGINIA—FORMER PRESIDENT OF THE AMERICAN BAR ASSOCIATION

When this ter-centenary of the first permanent English settlement in America I am impressed more than ever before with the words of my friend, Governor Henry A. Wise, that gallant Virginian, who in speaking of Jamestown, eloquently exclaimed: "Here the old world first met the new. Here the white man first met the red

for settlement and civilization. Here the white man wielded the ax to cut the first tree for the first log cabin. Here the first log cabin was built for the first village. Here the first village rose to the first State Capital. Here was the first capital of our empire of states—here was the very foundation of a nation of freemen, which has stretched its dominion and its millions across the continent to the shores of another ocean. Go to the Pacific now

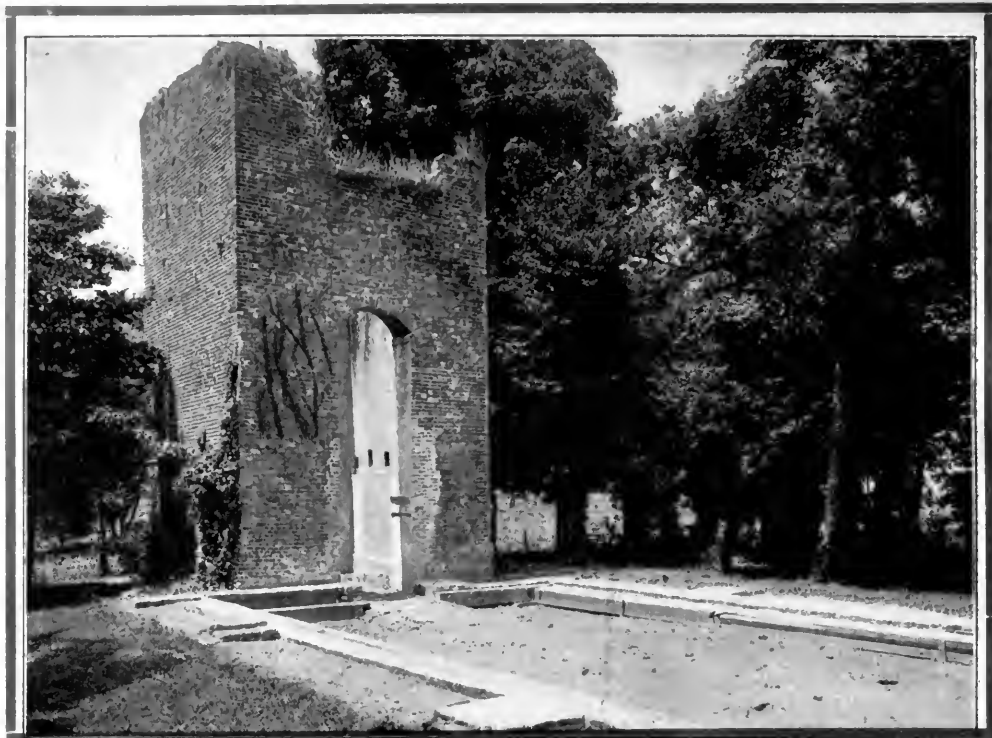

OLDEST RUINS OF A PROTESTANT ECCLESIASTICAL STRUCTURE IN AMERICA
Historic Tower of the Old Church at Jamestown, Virginia—Remains of the third edifice of the first Protestant organization in New World—Preserved by Society for Preservation of Virginia Antiquities

to measure the progression and power of a great people.”

“And it is here,” adds President Tyler of the grand old College of William and Mary, “that the new world witnessed the first trial by jury, the first English church, the first English marriage, and its first legislative assembly.”

The whole English-speaking world must pay homage to Old Jamestown on this three hundredth anniversary. In it is written much of the earth's history, for as Dr. Tyler says: “Had the expedition that came to Jamestown in 1607 failed of a permanent footing on these shores, the opportunity of establishing here an Anglo-Saxon colony might have passed away never to return. The Spaniards, who claimed all North America,

might have, by establishing settlements of their own, prevented any further attempt on the part of the English.”

It is therefore not an idle speculation to consider America as she might have been to-day—a Spanish-speaking nation, or, possibly lost by Spain in some of the wars that would have arisen, under the colonial government of one of the Old World monarchies. It does not seem possible that the American spirit could ever have been held in subjection whatever might have been its guardianship. The very air of the continent, wherever one may go from ocean to ocean and from the snows of the farthest northern boundary to the tropical fragrance of the Southland, is the breath of Self-Government—the nature-stilled air of the Republic.



BUST OF JOHN SMITH
By Baden Powell, Sculptor



An Old English Oil Painting of Captain John Smith, painted after the engraved portraiture of the adventurer in his own book, when he was thirty-seven years of age, in 1616, the year that Pocahontas went to England, the wife of John Rolfe, and was presented at the Court of King James as "Lady Rebecca"—Captain John Smith died at the age of fifty-three years, after a life of remarkable adventures

The First Permanent English Settlement

It is with these sentiments in mind that it is well for every American—and every brother of the great brotherhood of nations—to look back through the panorama of three hundred years to that notable day in 1607 when the British flag planted the first permanent English-speaking settlement on the Western Hemisphere, and endowed it with its mother-tongue.

Wonderful tales of the Golden Land of promise were being told in the Old World. London was agog with the news of its resources. Adventurers, poets, playwrights, were gathering in London and the New America was the talk of the taverns. Old London in this day of the dawn of the New World was an interesting picture. I can do no better than to describe it in the words of Edwin Fulton Rorebeck who, in speaking of London as the mother of Virginia, said a few days ago:

London was the metropolis, the great feeder for England, Scotland and Ireland, and the guilds or companies of Salters, Vintners, Drapers, Goldsmiths, Haberdashers, Skinners, Mercers, Grocers, Fishmongers, Tailors, Ironmongers, Clothworkers, were laying the foundations which were to make the city the great commercial clearing house for the whole world. While the town had a solid citizenship—peaceable folk, such as shop and tavern keepers, artisans, Thames boatmen, and drawers of sack and “carowses”—it was also a day of a floating, superficial population made up of idle rich, needy adventurers, discharged sailors and soldiers, roysters, “Roaring Boys,” poets, playwrights and actors, living by their wits, keeping London in good humor, and incidentally being thrust into jail for *lese majestie*. Gallants, adventurers, poets, hobnobbed together at the taverns which abounded in London—the Mermaid, the Horn, the Cock and Bottle, the Old Boar’s Head, the Cheshire Cheese—these are the names of the trysting places where Shakespeare, Ben Jonson, Smith and

Gosnold, and others of their ilk, scribblers and sword-stickers, fraternized and sought inspiration in huge “carowses” of sack. Here ballads destined to become classics were written and sung; here brave enterprises which changed the world’s cosmography were conceived and later carried into execution.

The fever of speculation was in the air, rich and poor fell victims to the plague. Virginia, the beautiful, mysterious, unknown land across the great waters, was reputed to be fabulously rich in gold and other precious metals. Tales were told in the tap-room of a city of gold located in the interior of America, a city of which the Spaniards had accurate information and for which they were searching.

The closing years of the sixteenth century witnessed a great awakening in the public mind of England regarding the possibilities of colonial expansion. It had taken one hundred years to bring about this awakening; one hundred years of imagination, of vague rumors and reports and of maritime ventures, since Columbus opened the ponderous gates of the Atlantic: one hundred years of desultory exploration without a resulting settlement. But now things were taking on a new appearance. The Spanish Armada had but recently been destroyed, and the country of Elizabeth had become “Mistress of the Seas,” ready and eager under the flush of success to extend the power and supremacy of the nation to the bounds of the earth. The El Dorado of the New World offered the best field for the test of this exuberance of popular feeling whether the motive be commerce, romance, ambition, love of adventure, freedom from restraint or religion.

This passion received a decided check, however, by the disastrous attempt of Sir Walter Raleigh to found a colony in the New World. In 1584, Raleigh sent out two vessels under the Captains Armidas and Barlow and these traversed the Carolina

1607 Ter-Centennial in America 1907



MASSACRE IN 1622 IN FIRST PERMANENT SETTLEMENT IN AMERICA

Old Print in the *Scheeps-Togt van Anthony Chester Na Virginia*,
gedaan in het jaar 1620—Printed at Leyden by Peter Vander in 1707

coast and named the country Virginia. The next year a colony of one hundred and eight men made a settlement on the Island of Roanoke but one year sufficed for the experiment when the colonists abandoned their lovely hamlet and returned to England. The next year fifty men left at the deserted settlement were massacred by the Indians. But Raleigh was not yet discouraged. A new colony was planted and this time the solitude was cheered by the presence of woman. But this did not avail, and of the fate of the colony we know nothing. The settlement and the settlers disappeared without a trace of their fate. The only thing known of their year's existence there is the fact that a female child was born there and it was named Virginia. These disasters gave the colonization scheme such a set-back

that for fifteen years Virginia lay abandoned and obscure.

The great East India Company had been organized, in 1600, and was throwing open the gates of the rich East. Sir Francis Drake, in 1577-1580, had encircled the globe. The wealth of the Western World awaited the men with the courage to come and take it.

At this juncture Captain John Smith arrived in his native country after many years of adventure in Morocco, Turkey and the Orient. In company with Bartholomew Gosnold, Edward Maria Wingfield, Robert Hunt and others, Smith began urging the colonization of Virginia and as a result letters patent were issued by the King, James I, to the territory on the sea-coast of America from the thirty-fourth to the thirty-eighth degrees, north latitude, to-

The First Permanent English Settlement

gether with all the islands within a hundred miles of these shores and extending to the Western Ocean.

Under this authority there set sail from Blackwall, England, on the nineteenth day of December, 1606, one hundred and five aspiring colonists. These vessels were the "God Speed," "Discovery," and "Susan Constant," the largest being of less than one hundred tons burthen.

The beginning of the voyage was inauspicious and discouraging. Buffeted about by angry seas for six weeks before losing sight of their home land, internal dissensions were added to their discomforts. At last they encountered more favorable weather, and, by the old circuitous route, reached the West Indies where they landed and carried on a smart trade with the "Salvages." After resting several weeks they resumed the journey toward Virginia. Their expectation was to land on Roanoke Island but one of the great Cape Hat-

teras storms bore them out of their course and carried them beyond their expected landing place. So it was that on the twenty-sixth day of April, 1607, they made the coast of Virginia and landed at a point which they named Cape Henry. To the opposite point they gave the name Cape Charles, both names being in honor of the sons of their King. A party of thirty went ashore at Cape Henry to recreate themselves and received their first lesson in Indian warfare, being attacked by a body of savages who crept upon them from the hills and forests. In looking about for the best place for a settlement the colonists cruised about for two or three weeks. They anchored at a point which they called Point Comfort and partook of the oysters which they gathered along the beach and of the strawberries which they said were fine, "four times bigger and better than ours in England." But they were not quite satisfied with Point

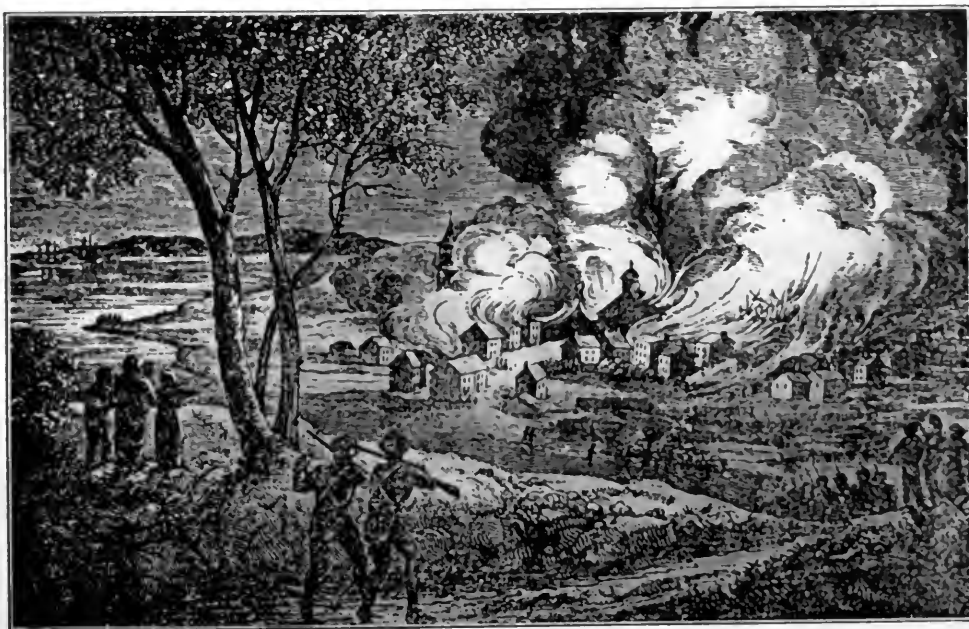

BURNING OF FIRST PERMANENT ENGLISH SETTLEMENT IN AMERICA
Old print in the archives of the Historical Exhibit at the Jamestown Exposition

1607 Ter-Centennial in America 1907



[Enlarged from a cut in the *Scheeps-Tocht van Anthony Chesler Na Virginia, gedaan in het jaar 1620*. Printed at Leyden by Peter Vander, 1707. A pamphlet. 12mo.]
FIFTEEN YEARS AFTER FIRST PERMANENT ENGLISH SETTLEMENT IN AMERICA

Comfort as a location for their settlement, and, proceeding up the river, which they called James, they hoped to find a better place. It may be, too, they still had thoughts of that *ignus fatui* of all the early explorations, the Northwest Passage to India. On the thirteenth day of May they moored their boats to the trees and landed on a projection from the northern shore of the river and that very day the ax was buried in the trees of the primeval forest and the first shafts were hewn out for the foundation of the city of the Royal James, henceforth to be called Jamestown, the first permanent English settlement in the New World.

Of the trials and tribulations of this infant settlement, the world is familiar. There were seasons of sunshine and seasons of shadow, times of plenty and starving times; there were dissensions within and savage treachery and cruelty without. So many were the discouragements that the colony must have perished miserably had not the masterful spirit of John

Smith prevailed. He it was who pacified the Indians and procured from them the life-sustaining corn; he it was who quieted the internal strifes by firmness and a requirement that "he who will not work shall not eat."

Three hundred years have passed away since this memorable day in May, 1607, but, despite the spirit of commercialism which is abroad in our fair land, there are thousands of brave souls and true, from the ice-bound North to the sun-kissed South, that thrill with patriotic pride at the remembrance of "Old Jamestown." This village, for it was never more than a village, was verily the keystone of the arch of "the land of the free and the home of the brave."

Little now remains of this cradle of the English race in America, except the ruins of the tower of the old church within whose walls nearly three centuries ago the Gospel was preached and songs of praise went up from the great hearts of those brave adventurers who were ready to suffer,

The First Permanent English Settlement



ROYAL ARMS AND SEAL ON THE FIRST MAP OF THE FIRST ENGLISH SETTLEMENT IN AMERICA—Issued in John Smith's "Historie" published in London, England, in 1629

yea to die, if need be, to plant the standard of liberty on the soil of America. This old tower has well withstood the storms, vandalism and neglect of nearly three hundred years and stands to-day an impressive landmark, a prophetic reminder of the mutability of all things material.

Lancet slits high up in the tower indicate that it was used as a fort or block-house against sudden attacks of Indians. In our minds' eye we can see rough old Sir William Berkley or the noble Nathaniel Bacon going through these narrow slits, but not on the same day, as Bacon and the governor never could agree. Ivy creeps over the ruined walls of the tower, clinging to the bricks like the historical associations which cluster about everything connected with the place.

This was not the first church but most likely the third. The first was made by "hanging up an old sail, fastening it to three or four trees, seats of logs, and a bar of wood be-

tween two trees served for a pulpit." The next, so says Smith, was "like a barn, set upon crotchets." The third was the one on which the old tower still stands. On this spot Pocahontas, the tried and true friend of the English, received the rites of Christian baptism and here she was married to John Rolfe, April, 1614. Powhatan readily consented to the alliance and sent his brother to give away his daughter. It was a memorable day, as may be supposed, in the annals of Old Jamestown and it may be doubted whether a single adult in the colony was absent from the ceremony. Sir Thomas Gates beamed with happiness while the dusky countenances of the brothers of Pocahontas and other youths and maidens of the forest glowed with pleasure.

In the churchyard about the old tower lies the tombs of the Sherwoods, the Blairs, the Harrisons, Lady Frances Berkley and many others whose names are familiar to every schoolboy and girl of the land. Men and women of high degree or low, they sleep side by side "waiting for a Joyful Resurrection" as some of the inscriptions on the tombstones declare. The old fort of colonial days was near the church and its ruins are still discernible. It was used by Cornwallis as a part of his fortification in the closing campaign of the



GRAVES OF THE FIRST SETTLERS
One of first interments in Jamestown

1607 Ter-Centennial in America 1907



RUINS OF FIRST PERMANENT ENGLISH SETTLEMENT IN AMERICA

Old Ambler Mansion on Jamestown Island—Preserved by the Society for the Preservation of Virginia Antiquities

Revolution and again by General McClellan in the Civil War. Save for these two interruptions the solitude of the place seems not to have been disturbed from the date of the abandonment of the colony in favor of Williamsburg in 1699, to 1892, when the patriotism of the country cried out for the preservation of the historic ruins and the Association for the Preservation of Virginia Antiquities secured the title to the property. Since that date much has been done to preserve the place from further demolition and also to restore the foundations of some of the ancient buildings. The general government has erected a bulwark to prevent the never-ceasing tide of the mighty James from making further inroads upon the sacred soil, many acres of which it has long since carried toward the sea.

In addition to the Ter-Centennial Exposition which opens April 26, on

the shores of Hampton Roads, in commemoration of the three hundredth anniversary of the founding of this settlement, the national government will this year commemorate the event by the erection of an obelisk within the limits of the first settlement. Thus at last Jamestown is coming into its own.

The American people are now gathering at the shrine of the Nation's birth; the peoples of the earth are paying homage to the Western Continent, to-day one of the greatest powers in civilization; the brother nations of the Eastern Continent are extending a beautiful tribute of Good Will by sending their military and naval emissaries to join the wonderful pageant of Peace in which the soldiers of all flags are to march side by side in the Land of the Stars and Stripes.

The United States has never hitherto permitted armed companies of

The First Permanent English Settlement

foreign soldiery to visit this country; consequently for the first time Americans will see an international encampment—the greatest military spectacle the world has ever seen—the grandest naval rendezvous in history.

It is, indeed, a bright omen of the future when the soldiers and sailors of all nations meet in Peace and Friendship. It also is beyond comprehension to consider this vast wil-

derness of three hundred years ago and then gaze upon it as a World Power to-day, and to realize that quaint Old Jamestown is in a few short days to witness the competitive flights of the airships of all countries, the races of dirigible balloons for commercial purposes, and see the conceptions of the brain of men and the products of man's skilful hand of three marvelous centuries.

Truly, this is an Age of Wonders!

A N O L D E N G L I S H P L A Y O N A M E R I C A

The New World was the Talk of the Taverns in the Old World—Gallants, Adventurers and Poets told tales of its Fabulous Riches — Playwrights made mention of it in their Dramas—One of Popular Plays of the Day was "Westward Hoe," written by Johnson, Chapman and Marston, in which appear these lines:

Scapethrift: Is there such treasure there, Captain, as I have heard?

Captain Seagull: I tell thee, golde is more plentiful there than copper is with us; and as for much redde copper as I can bring, Ile have thrice the waight of gold. Why, man, all their dripping pans and their chamber pottes are fine gold; and all the chaines with which they chaine up their streets are massie gold; and all the prisoners they take are fettered in gold; and for rubies and diamonds, they goe forth on holy days and gather 'hem by the seashore, to hang on their children's coates, and stick in their capps, as commonly as our children weare saffron guilt brooches and groates with hoales in 'hem.

Scapethrift: And is it a pleasant countrie withall?

Seagull: As ever the sun shinde on; temperate and full of all sorts of excellent viands; wilde boare is as common as our tamest bacon is here; venison as mutton. And then you shall

live freely there, without sargeants, or courtiers, or lawyers, or intelligencers. . . . Then for your meanes to advancement, there it is simple, and not preposterously mixt. You may be an alderman there, and never be scavenger; you may be a nobleman, and never be a slave. You may come to preferment inough, and never be a pandar; to riches and fortune inough, and have never the more villiance, nor the lesse wit. Besides, there we shall have no more law than conscience, and not too much of either; serve God inough, eat and drinke inough, and "inough is as good as a feast."

Spendall: Gods me! and how farre is it thether?

Seagull: Some six weekes sayle, no more, with any indifferent winde. And if I get to any part of the coast of Africa, Ile saile thether with any winde or when I come to Cape Finister, ther's foreright winde continuall wafts us till we come at Virginia.



This portraiture of Pocahontas is from a rare engraving now in the possession of Mrs. Herbert Jones, of Sculthorpe Rectory, near Fakenham, England, and believed to be an original by Simon de Passe. It is embellished with a Latin inscription and is a small quarto-size engraving that may possibly be the one referred to in the letter of March 29, 1617, quoted in Birch's "Court and Times of James I," which reads: "The Virginian woman, whose picture I sent you, died this last week at Gravesend as she was returning homeward." There is another portrait, that claims to be the original of Mrs. Stewart, of Heachem, England, representing Pocahontas in native costume, seated, with her only child, the John Rolff from whom some of the first Virginia families have sprung, standing at her side. There is no inscription on this ancient English canvas but it bears all the marks of authenticity

The First Romance in America

THERE is no romance in American Literature more beautiful than that of the Indian princess, Pocahontas, her womanly courage and fortitude, her fidelity to the white race and the dawn of the light of civilization which lifted her from savagery to the Court of King James and the admiration and love of the English-speaking world.

The American people should pay homage to her memory on this anniversary of the deeds of heroism in which this beautiful Indian girl offered her life to the cause of civilization. Whether or not the tradition of the rescue of the gallant John Smith, as he was about to be slain by her father's tribe, is true does not in the least diminish the nobility and the beauty of this Indian maid. That she was the power behind the throne is beyond all doubt and to her must be given the credit for the influence that several times saved the absolute extermination of the English-speaking settlement which to-day claims the attention of the world as the cradle of the Republic.

The first Anglo-American alliance, the first union of continents—in truth the blending of the American-born strain with the strong blood of Europe, a strain that has ever since and is to-day making the American race the strongest on the face of the earth—was that of this daughter of the American Indians and a son of Old England. From this union has descended many of the illustrious Virginians who have full claim to blood more noble than monarchal royalty—a blood that has forced civilization along.

On that notable wedding day, in April of 1614, the American aborigines and the white men concluded a peace which was stamped in brass and proclaimed to whomsoever it might concern. The little church with pews and pulpit of cedar was trimmed with sweetest April flowers. Pocahontas, the bride, the daughter of the old war-chief, Powhatan, was



Memorial Window presented by the Indian Girls of Hampton Institute to St. John's Church at Hampton, Virginia, the oldest standing Protestant Ecclesiastical structure on the Western Continent



Old engraving of Pocahontas Rescuing Captain John Smith

led to the altar by her aged uncle, Apachisco, with the consent of her father and friends. Two of her brothers were present, the ritual of the Church of England was read by Reverend Richard Buck, and the first citizens of the new America witnessed the union of the continents.

Three years before, Pocahontas had been baptized into Christianity and christened "Rebecca." Her true name, Matoaka, given her by her father at birth, had long been lost in the affectionate pet name of Pocahontas, meaning "little Wanton."

The bridegroom, John Rolfe, was a widower, a member of an ancient family of Heacham, County Norfolk, England, a strong man who had been secretary of state in the English colony and was highly respected. He took his Indian bride to England where her lovable disposition won the hearts of the English people. She was introduced at court by Lord and Lady Delaware and her name was on the lips of the English aristocracy. Some of the old state records bear these entries:

1616, June. Sir Thomas Dale returned from Virginia and brought divers men and

women of that country to be educated in England. One Rolfe also brought his wife Pocahuntas the daughter of Powhatan—"the Barbarous Prince."

While in the full light of Old World civilization the darkness of the long night fell upon her, and these last few lines from the old state records close the story.

1617, 18 Jan., London. The Virginia woman Pocahuntas has been with the King. She is returning home sore against her will.

1617., 29 March, London. The Virginia woman died at Gravesend on her return.

The register of the Church at Gravesend relates:

1616, May 2, Rebecca Rrolf, wyff of Thomas Rrolf, gent. A Virginia Lady borne, was buried in the Chauncell.

One year later, in 1618, the old war-chief, Powhatan, scarred by many a conflict between savagery and civilization, went to his sleep and while to-day the English-speaking people of the world are paying homage to the memory of this dear daughter of the forests, who would dare say that she who died in the golden light of civilization is not resting in the arms of her barbarian father upon whom the light of understanding never dawned?



Chapman's Famous Picture of the Baptism of Pocahontas in 1614



Old Engraving of the Marriage of Pocahontas to John Rolfe about April 15, 1614

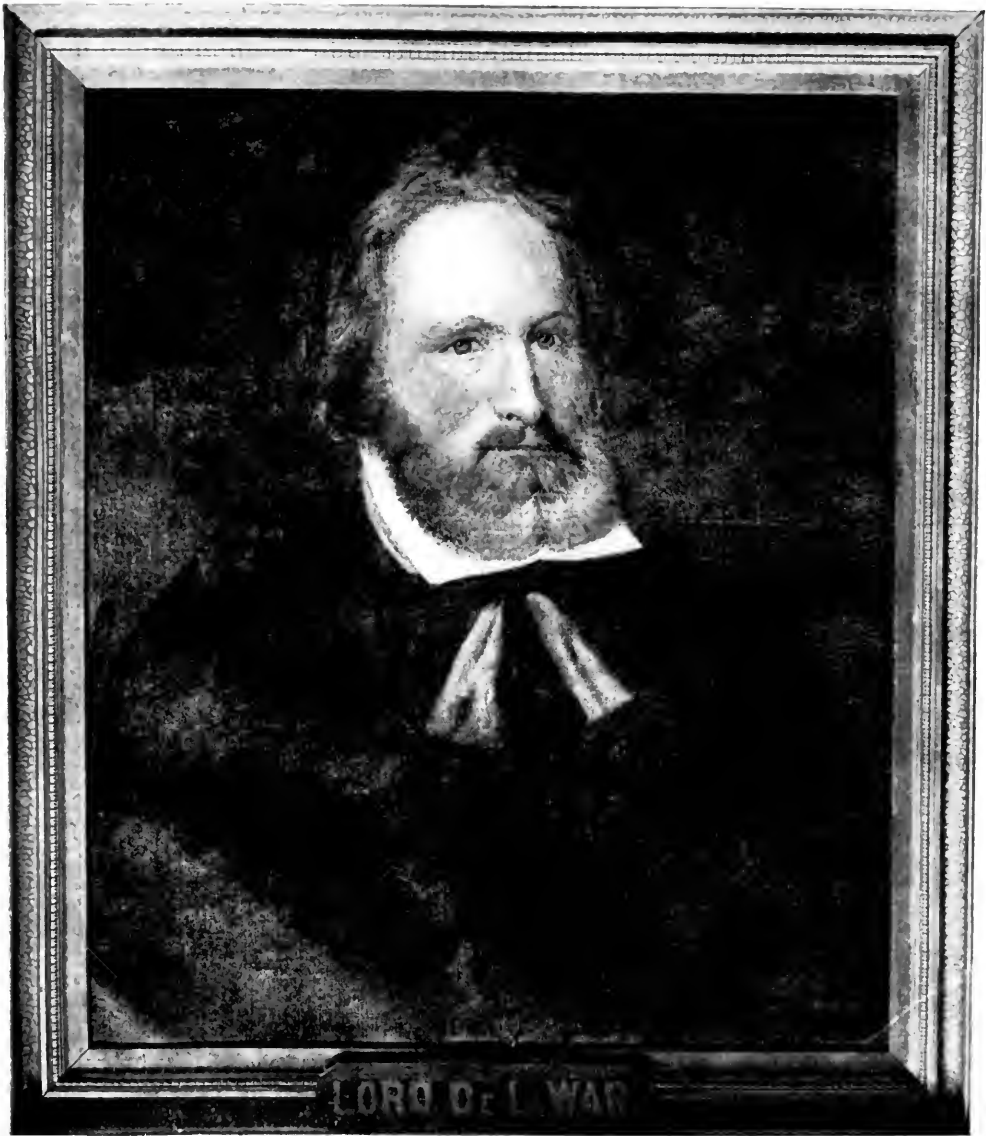

Oil Painting of Lord Delaware
Who Arrived at Jamestown on June 10, 1610
And Introduced Pocahontas to the Court of King James in England in 1617
Original in Possession of the
Society for the Preservation of Virginia Antiquities
in the State Capitol at Richmond, Virginia

224



BRONZE STATUE OF CAPTAIN JOHN SMITH
BY WILLIAM COUPER OF NEW YORK
TO BE UNVEILED AT JAMESTOWN ISLAND
SEPTEMBER, NINETEEN HUNDRED AND SEVEN
BY THE SOCIETY FOR THE PRESERVATION OF VIRGINIA ANTIQUITIES

In Honor of a Valiant Adventurer

These Loving Lines Inscribed to Gallant John Smith by
his Compeers are again dedicated to him on this Thire
Hundredth Anniversary of his American Explorations

TO HIS DESERVING FRIEND

Mongst Frenchmen, Spanyards, Hungars,
Tartars, Turks,
And wilde Virginians too, this tells thy
works:
Now some will aske, what benefit? what
gaine?
Is added to thy store for all this paine?
Th' art then content to say, content is all,
Th' ast got content for perils, paine and
thrall;
Tis lost to looke for more for few men
now
Regard Wit, Learning, Valour, but allow
The quintessence of praise to him that can
Number his owne got: gold, and riches,
than
Th' art Valiant, Learned, Wise, Pauls
counsel will,
Admire thy merits, magnify thy skill,
The last of time to which I set my hand
Was a Sea Grammar: this by Sea and
Land,
Serves us for imitation: I know a man
That like thy selfe has done and more,
and gone
To such praise-worthie actions, that his
praise
Th' ast well deserv'd as that man, to be
found:
If France, or Spaine, or any other
could showe such deeds, let them be
knowne and told:
To such great actions, our nation
ought
To have such praises, as the world
has
To such great actions, as the world
has
To such great actions, as the world
has

TO MY WARRING FRIEND

Deare noble Captaine, who by Sea and
Land,
To act the earnest of thy name hast had
And heart; who canst with skill designe the
Fort,
The Leaguer, Harbour, City, Shore, and
Port:
Whose sword and pen in bold, ruffe, Mar-
tiall, wise,
Put forth to try and beare away the prize,
From Caesar and Blaize Monluc: Can it be,
That Men alone in Gonnals fortune see
Thy worth advanc'd? no wonder since our
eyes
See now at large a Bedlem or a Stage.

RICH. JAMES.

TO HIS APPROVED FRIEND

To combate with three Turkes in single
dule,
Before two Armies, who the like hath
done?
Slaine thy great sailor; found a common
weale
In faire America; where thou hast
wonne
No lesse renowne amongst their Savage
Kings,
Than Turkish warres, that thus thy hon-
our sings.
Could not those tyrants daunt thy match-
lesse spirit,
Nor all the cruelty of envies spight?
Will not thy Country yet reward thy merit,
Nor in thy acts and writings take delight?
Which here in so few sheets doth more ex-
press
Than volumes great, this is thy happi-
ness
RICHARD MEADE.

TO HIS NOBLE FRIEND

To see bright honour sparkled all in gore,
Wounde made a spirit that ne're fought be-
fore
And that's the height of Fame, when our
best blood,
Is nobly spilt in actions great and good:
So thou hast taught the world to purchase
Fame,
Reading the story on a glorious frame,
And such foundation doth thy merit make
As all ambition rage shall never make
The world to love themselves, and thy
deeds
To such great actions, as the world
has
To such great actions, as the world
has

Thy noble spirit, who by Sea and Land,
To act the earnest of thy name hast had
And heart; who canst with skill designe the
Fort,
The Leaguer, Harbour, City, Shore, and
Port:
Whose sword and pen in bold, ruffe, Mar-
tiall, wise,
Put forth to try and beare away the prize,
From Caesar and Blaize Monluc: Can it be,
That Men alone in Gonnals fortune see
Thy worth advanc'd? no wonder since our
eyes
See now at large a Bedlem or a Stage.

RICH. JAMES.



BRONZE STATUE OF CAPTAIN JOHN SMITH
BY WILLIAM COUPER OF NEW YORK
TO BE UNVEILED AT JAMESTOWN ISLAND
SEPTEMBER, NINETEEN HUNDRED AND SEVEN
BY THE SOCIETY FOR THE PRESERVATION OF VIRGINIA ANTIQUITIES

In Honor of a Valiant Adventurer

These Loving Lines Inscribed to Gallant John Smith by
his Compeers are again dedicated to him on this Three
Hundredth Anniversary of his American Explorations

TO HIS DESERVING FRIEND

Mongst Frenchmen, Spanyards, Hungars,
Tartars, Turks,
And wilde Virginians too, this tells thy
works:
Now some will aske, what benefit? what
gaine?
Is added to thy store for all this paine?
Th' art then content to say, content is all,
Th' ast got content for perils, paine and
thrall;
Tis lost to looke for more: for few men
now
Regard Wit, Learning, Valour; but allow
The quintessence of praise to him that can
Number his owne got gold, and riches,
than
Th' art Valiant, Learned, Wise; Pauls
counsell will,
Admire thy merits, magnifie thy skill.
The last of thine to which I set my hand
Was a Sea Grammar; this by Sea and
Land,
Serves us for imitation: I know none,
That like thy selfe hast come, and runne,
and gone,
To such praise-worthy actions: bee't ap-
prou'd,
Th' ast well deserv'd of best men to be
lou'd:
If France, or Spaine, or any forren soile
Could claime thee theirs, for these thy
paines and toile,
Th' adst got reward and honour. now
adayes,
What our owne natives doe, we seldome
praise.
Good men will yeeld thee praise; then
sleight the rest;
Tis best praise-worthy to have pleas'd the
best.

TUISSIMUS ED. IORDEN.

TO MY WORTHY FRIEND

Deare noble Captaine, who by Sea and
Land,
To act the earnest of thy name hast hand
And heart; who canst with skill design the
Fort,
The Leaguer, Harbour, City, Shore, and
Port:
Whose sword and pen in bold, ruffe, Mar-
tiall, wise,
Put forth to try and beare away the prize,
From Cæsar and Blaize Monluc: Can it be,
That Men alone in Gonnals fortune see
Thy worth advanc'd? no wonder since our
age,
Is now at large a Bedlem or a Stage.

RICH. JAMES.

TO HIS APPROVED FRIEND

To combate with three Turks in single
du'le,
Before two Armies, who the like hath
done?
Slaine thy great Iailor; found a common
weale
In faire America; where thou hast
wonne
No lesse renowne amongst their Savage
Kings,
Than Turkish warres, that thus thy hon-
our sings.
Could not those tyrants daunt thy match-
lesse spirit,
Nor all the cruelty of envies spight?
Will not thy Country yet reward thy merit,
Nor in thy acts and writings take delight?
Which here in so few sheets doth more ex-
presse
Than volumes great, this is thy happi-
nesse.

RICHARD MEADE.

TO HIS NOBLE FRIEND

To see bright honour sparkled all in gore,
Would steale a spirit that ne're fought be-
fore:
And that's the height of Fame, when our
best bloud,
Is nobly spilt in actions great and good:
So thou hast taught the world to purchase
Fame,
Rearing thy story on a glorious frame,
And such foundation doth thy merits make
it,
As all detractions rage shall never shake
it;
Thy actions crowne themselves, and thy
owne pen,
Gives them the best and truest Epiphonem.

BRIAN O ROVRKE.

Thou hast no need to covet new applause,
Nor doe I thinke vaine-glory moves thee
to it;
But since it is thy will (though without
cause)
To move a needlesse thing, yet will I doe
it.
Doe it in briefe I will, or else I doe the
wrong,
And say, read or'e Captaine Smiths for-
mer song;
His first then will invite thee to his latter:
Reader, 'tis true; I am not brib'd to
flatter.

EDW. INGHAM.

American Progress on the Pacific Coast

Voice of the People as Expressed through Messages
from the Governors of the American Commonwealths

TO

THE JOURNAL OF AMERICAN HISTORY

BY

HONORABLE ALBERT E. MEAD, GOVERNOR OF WASHINGTON



Albert E. Mead

THE coast of the State of Washington was visited by the early English, Spanish, and Portuguese explorers in the sixteenth, seventeenth and eighteenth centuries.

To Vancouver, the English explorer of the latter part of the eighteenth century, is due the first full and authentic information regarding our coast line and the indentures of the sea. The search for the fabled Straits of Anian led the early navigators to our shores. The first American to visit the region now embraced in Washington was Captain Gray, of Boston, in 1789. His expedition consisted of the ships "Columbia" and "Washington." This visit, antedating that of Vancouver, forms part of the American title to all of the old Oregon country, which now embraces all of the states of Oregon, Washington, and Idaho, and that portion of Montana lying west of the main range of the Rocky Mountains. Our title to the region reads, "by occupation and discovery."

As early as 1809, American trap-

pers visited what is now the State of Washington. In 1811, Stewart and Ross, of the Pacific Fur Company, at Astoria (John Jacob Astor's Company) established trading posts on the Spokane and the Okanogan rivers, and remained over the winter there. Other Americans, in later years, also established trading posts in various parts of the territory which afterwards became Washington.

It will be recalled that during the War of 1812 the British secured possession of the trading post at Astoria, and that for a number of years thereafter the post was administered by the Hudson Bay Company. Astoria is now in the State of Oregon, being on the south bank of the Columbia River. In 1825, Dr. McLaughlin, chief factor of the Hudson Bay Company, removed the headquarters of the concern from Astoria to the more advantageous locality of Vancouver, on the north bank of the Columbia River, now in the State of Washington. There the Company built up an extensive post; surrounding it by more than three thousand acres of

Message from Washington by Governor Mead

farm land, which it tilled assiduously; and establishing in connection with it the headquarters for all the Hudson Bay Company's operations in the region lying north of the then Mexican boundary (now the northern boundary of California), north to the Arctic Ocean and east to the Rocky Mountains. All the region then was claimed by Great Britain; and its affairs both politically and commercially were handled solely and exclusively by the Hudson Bay Company. Vancouver was the real capitol of the great province. From Vancouver went out Peter Skeene Ogden, a minor official of the Hudson Bay Company, to discover the river in Utah which now bears his name, and which in turn gave its name to the prosperous city of Ogden. From here also went the men to establish the first settlements in what is now British Columbia.

Following the Hudson Bay Company came the missionaries. The first real American settlement in Washington, aside from the fur posts, was that made by the missionary, Marcus Whitman, at Waiilatpu, in 1836. There he and many others met their death in an awful massacre by the Cayuse Indians, in 1847. Early in the forties the tide of western emigration began to flow toward the Oregon country; and hundreds of families moved across the plains in ox-carts and wagons to found homes in the fertile valleys of this region. The Willamette, now in Oregon, seemed to be the first objective point; but from there many penetrated into what is now Washington; and in 1844 established the first settlement on Puget Sound, at Tumwater.

In 1853, Congress created the Territory of Washington out of a part of the Territory of Oregon; and the new political organization came into being on March 2, 1853. It then included all of what is now Washington, Idaho, and the western part of Montana. Its next door neighbor on the east was the Territory of Nebraska.

The Northern Pacific Railroad was completed to Puget Sound from the head of Lake Superior in 1883; and following its completion population increased rapidly. In 1889, when the Territory contained a population of 242,046, Washington was admitted to the Union as a State, the exact date of admission being November 11.

A new commonwealth, far off here on the Western shore of the continent, Washington has yet played her part in the history of the Nation. During the savage Indian wars of 1854-55-56 she put two regiments of volunteers into the field. In 1862, when the population of the Territory perhaps did not exceed ten thousand souls, she gave a full regiment for the defense of the Union. Lack of transportation, and because of its need at home to take the place of the regulars withdrawn for the war, caused this regiment to spend its four years of service on the Coast; doing not idle garrison duty, but holding the savage tribes in check. In addition to these contributions to the arms of the Nation, many of the citizens of the Territory served notably in the Union Army in other organizations. Chief among them all was Isaac Ingalls Stevens, a West Point graduate, a distinguished engineer officer of the Army in the Mexican War, and the first governor of the Territory of Washington. Stevens also had served as delegate in Congress from the territory from 1857 to 1861. At the beginning of the war he tendered his services to the government, and rose by various stages to be major-general of volunteers. His dramatic death at the Battle of Chantilly, in 1862, while leading his division in a charge is part of the National history. It is interesting to note also that J. Patton Anderson, who came here in 1853 as first United States marshal for the Territory, and who served as delegate in Congress for Washington from 1855 to 1857, served with distinction in the Confederate Army during the war, rising to be brigadier-

American Progress on the Pacific Coast

general; and also served for a time in the Confederate Congress as a member from Florida.

In the days before the Civil War, Generals Grant, Sherman, Sheridan, and McClellan all served at army posts in Washington Territory; and these posts cherish many traditions about their associations. Pickett, afterwards a great Confederate general, famous for his charge at Gettysburg, as a captain in the Ninth United States Infantry, played a prominent part in the early life of Washington. In 1857 and 1859, when the dispute as to the boundary line in the extreme northwestern part of Washington came near plunging this country and Great Britain into war, Pickett was in command of the American forces which landed on the islands in dispute and held them for this government. Captain Raphael Semmes of the Navy, later commander of the Confederate privateer "Alabama," was in those days in command of the vessel of the American Navy in these waters, and co-operated with Pickett.

The period between the establishment of Washington as a territory and the completion of the Northern Pacific Railroad, was one of slow growth for the Territory, but was marked by material progress. The people developed, in a measure, the wonderful resources of the commonwealth; shipped their lumber from the ports of Puget Sound to the ports of the civilized world; opened up coal mines; and even built a railroad with their own resources long prior to the time when steel rails connected them with other portions of the continent. The last ten years has been the period of the State's greatest development and progress. The population of the State now is approximately 900,000, as against 518,103 in 1900; this in an area of 66,880 square miles. Ridged through its approximate center from north to south by the Cascade Mountains, the State has two markedly different regions. The Western portion, which now contains the bulk of

the population, is notable for its fine harbors, its enormous areas of standing timber, its manufacturing enterprises, its fertile valleys, its stores of coal and minerals, its enormous trade by direct lines of steamships with the Orient, Alaska, and the maritime nations of the world, and its remarkably prosperous cities, chief of which is Seattle, with a population of approximately 200,000. Tacoma, also on the Sound, has a population of 85,000, and is growing rapidly. Bellingham, Everett, Aberdeen, Hoquiam, and Olympia also are important towns.

The eastern portion of the State, while great in manufacturing and other departments of industry, is chiefly notable for its agricultural and horticultural resources. It produces approximately 35,000,000 bushels of wheat per year, and other agricultural products in proportion. The chief city of Eastern Washington is Spokane, with a population of 80,000. Other important towns are Walla Walla, Yakima, and Ellensburg.

The fish products of the State aggregate a value of between \$10,000,000 and \$12,000,000 a year. Approximately 4,000,000 tons of coal are produced annually in the State. The lumber and woodenware products aggregate annually a value of about \$70,000,000. And in every department of industry the increase is notable. For instance, there are approximately 86,000 acres devoted to fruit culture in the State, an increase of one hundred per cent in the last two years. Irrigation in the arid and semi-arid regions of eastern Washington, the advent of the trolley line in rural communities, the great extension of all transportation facilities, contribute materially to this development. The Northern Pacific, Great Northern, and Harriman lines all have termini in the State, and other systems reach here by traffic arrangements with these. A notable feature of the present year has been the coming of various other transcontinental lines. Nearly 2,000 miles of

Message from Washington by Governor Mead

new mainline railroad tracks are now under construction within the State, to be added to the 3,300 miles of mainline that the State now contains. In addition to this 3,300 miles of mainline there are approximately six hundred of side-track. In the last eighteen months, millions of dollars have been expended by various systems in the purchase of terminal facilities on Puget Sound. Every railroad line of importance within five hundred miles of our shores is building hither.

In the State of Washington the pure American strain predominates. Our people are drawn chiefly from the other states of the Union, every section of the continent having a well-proportioned representation here. In addition, we have a considerable foreign-born population drawn chiefly from the United Kingdom and from the northern countries of Europe. A large portion of the foreign-born element has entered upon agricultural pursuits. In fact, the development of a number of our newer and richer agricultural sections is due entirely to the industry of newcomers from Northern Europe; and almost without exception these people are among the thriftiest and most industrious in the Commonwealth. In the intensely American atmosphere and environment of the State, the immigrants we have received have become quickly assimilated into our population. Immigration has had absolutely no evil effect on our citizenship.

This is a state of abundant opportunity for all industrious men and women. It would seem that there is something here worth while in every department of human activity. Labor commands the highest wage scale on earth, and is in constant demand. Our resources are being developed rapidly, but the development does not keep pace with the development of our constantly increasing markets. Our sea trade is becoming prodigious. The last fiscal year showed an increase of more than \$10,000,000 in

the export and import trade of our Puget Sound ports. All these things mean opportunity both for capital and labor. Hence there is no Capital and Labor problem in the State of Washington.

The greatest need of the State today is more transportation facilities. But this is coming rapidly. Of course, we need more industrious men and women, and more capital to develop our natural wealth. But these will come with the better transportation facilities. And parenthetically I might remark that this need of our State is but the need of the whole country. Transportation is a civilizer and a builder, for it creates opportunities.

We are proud of the population of the State of Washington, because it is the testimony of all careful observers that it is the most representative population of any American State. Drawn as it is from every portion of the Republic, and from the parent European stock, it is a fair sample of the population of the whole country. The composite Washingtonian is a composite American. That progressive, independent, sturdy patriotism that is finding its expression throughout the American Union, is well exemplified in the State of Washington. Our people are demanding better government here in Washington, and are paying more attention to the duties and responsibilities of citizenship than ever before. I think we are in advance of many of the states in this regard. But we are simply expressing, perhaps, more fervently than elsewhere the prevailing American assertion that all our governments, local or national, must be administered in accordance with the doctrine of the Square Deal; and that no privileged classes shall exist in any of our communities. The State of Washington is doing its utmost to maintain a high standard of citizenship. More than two-thirds of all the taxes paid in the State are expended for free education. In addi-

American Progress on the Pacific Coast

tion to the public schools maintained in every community, the State supports a State University, a State Agricultural College and School of Science, and three State Normal Schools. We have more than 2,500 school districts in the State, in two hundred and eighty-five of which there are schools of higher grade. These schools are taught by 5,179 teachers, and attended by 170,386 children out of a total of 207,099 children of school age within the State. The State demands high qualifications from its teachers. We are constantly drawing to the work of education in Washington the best material to be found in the country. Our school laws are enlightened and modern, our system of instruction that approved by the foremost men in the teaching profession.

You ask me if corporal punishment has been abolished. It has not. Its use lies within the judgment of the administrators of the schools themselves; and since the schools are administered by a high class of men and women, there has been no public demand for new regulations on this subject.

In all of our cities and towns churches are among the finest buildings. The number of these, and their attendance, denote that the people of this State are a God-fearing people.

To your concluding inquiry, "Do you believe that patriotism is waning or increasing in the United States?" I must reply most emphatically that patriotism is increasing in the United States, and that the citizenship is growing better year by year.

COMPULSORY MILITARY TRAINING IN AMERICA

Accurate Transcript from Original Order Issued in New England in 1765 and Contributed

BY BENJAMIN C. LUM

To Mr John Howd Clark of the First Training Band in Darby in ye 2d Ridgment Greeting—Whereas by a Courtmarshall held in Sd Darby by the Commissions Officers of Sd Train Band on the 3d Day of June A D 1765 these Several Persons hereafter names ware Ordered and Adjudged to pay the Several fines hereafter affixed to their names for nonappearance and Defiance in the Vewing of arms on the 6th Day of May 1765 being Training Day Duely warned whereof Execution Remains to be Done—These are therefore in his Majesties Name to Command you that of the goods Chattels or money of the Several Persons Hereafter names you Cause to be Levied the Several Sums after affixed to their names Viz Sergt Abraham Smith 1/6 William Burritt 1/6 Benjamin Davis 3/ Hezekiah Hine 3/ Ebenezer Henman 3/ John Humphrey 3/ Elijah Humphrey 3/ Abijah Hull 3/ Asahal Johnson 3/ Ashal Loveland 3/ Miah Pool 3/ Elias Durkins 3/ Thomas Voce 1/6 Stephen Whitne 3/ Jesse Wooster 3/ Turel Whitman 3/ William Bedels 3/ Elijah Davis wants Powder Joseph Short wants all but a Gun David Orsbon wants all but a Gun Benjamin Thomlinson wants a Gun and powder Samuel Thomlinson wants all but a Gun Edward Smithe wants all but a Gun Nichols Moss wants all but a Gun Jeremiah Blake wants all but a Gun David French wants all but a Gun and Sword and the Same being Disposed of paid and Delivered unto us the Subscriber the above Sd Sums together with one Shilling more for this writ also to Satisfy your own fees and for want of Such money Goods or Chattels of any of Either of the afore Sd Persons Sum or Sums you are hereby Comanded to take the Body or Bodys of any and Either of them and him or them Commit unto the Keepers of the Goal in New heaven within the Sd Prison who is hereby Comanded to Receive the Same and him or them Keep until he and they Shall pay the Full Sum or Sums above affixed to their names and also your fees and be Released in Du form of Law hear of Fail not and Du Return make within 60 Days Dated at Darby

Untold Riches of the Rocky Mountains

BY

HONORABLE FRANK R. GOODING, GOVERNOR OF IDAHO



Frank R. Gooding

IDAHO was first permanently settled, it is supposed, at the time of the location of the trading post at Fort Hall, about twelve miles from the present city of Pocatello, in 1834. A territory was created by act of March 3, 1863, from parts of Dakota, Nebraska and Washington Territories, and included all the area within the present states of Idaho and Montana and a large portion of the state of Wyoming. In 1863 Idaho was reduced to its present dimensions, extending from the British possessions on the North to Utah and Nevada on the South, and from Wyoming and Montana on the East, to Washington and Oregon on the West; having a length of four hundred and ten miles and a width varying from sixty to two hundred and fifty-seven miles.

The name "Idaho" was given it because of its mountainous character and is supposed to signify "Shining Mountains," or, as it is anglicized, "Gem of the Mountains." It was elevated to statehood in 1890, the present population being estimated at three hundred thousand people. It is a land of great diversity. In all portions of the state, practically in every county of the state, mining has

been pursued with profit in the past and is still the leading industry of the state, although profitable mining in a large way is now confined to but a few counties. In Northern Idaho, which term includes the five northern counties of the state, the people live largely by means of following mining, lumbering, stock-raising and the raising of grain and fruit. In central Idaho, which includes the three counties of Ada, Canyon and Washington, mining, lumbering, stock and fruit raising are the sources of revenue. In the thirteen southern counties the people generally follow mining and stock-raising.

During the past four or five years immigration into the state has been very heavy. These newcomers are largely American citizens from the middle West and Eastern states, although in some portions of the state where large irrigation plants have been put into successful operation, immigration has been in a large part from the coast states of Oregon and Washington. The increase in population has been caused very largely by the development of the timber and agricultural resources in the northern part of the state and by agricultural development in the southern part, brought about by the completion of irrigation propositions which has put

Message from Idaho by Governor Gooding

under cultivation almost half a million acres of semi-arid lands.

Idaho as yet is not confronted with the labor problem to any great extent. The public school system in the state is a very excellent one. So far there has been no interference with the forms of discipline that have been in vogue in the schools from the beginning. The development of the state seems to be in all lines, but especially in the way of making use of the enormous timber resources and in the putting in of irrigation plants which are of great value. Lands hitherto without value have by this means been made of use. There are a number of propositions, including two great government reclamation propositions, that are in process of development. One of these which

will make valuable about two hundred thousand acres of hitherto valueless lands, will be completed some time within the next few months.

The greatest need of the state, in my opinion, is the development of the railway system. Idaho, from its mountainous character, is divided geographically into many parts that are distinct from each other in character and difficult of access one from the other. This can be remedied only by the extension of railway lines within the state. There is now every indication that extensive railroad building will be witnessed within the state within the next few years, and it is anticipated that the increase in population by the taking of the next census will be much greater in proportion than during the past five or six years.

American Civilization in the Greater Antilles

BY



GOVERNOR OF PORTO RICO

THE Island of Porto Rico was discovered by Columbus on his second voyage to America. He landed on its western shore November 19, 1493. The first settlement was made in 1510 at a point on the mainland south of the harbor of San Juan. The original name of the

settlement was Caparra. Its deserted site is now known as Pueblo Viejo. In 1520 the colonists abandoned it and founded the present city of San Juan, which disputes with San German—in the southwestern corner of Porto Rico—the honor of being the oldest community in the Western Hemisphere.

In 1899 the census taken by the

American Civilization in the Greater Antilles

United States Military Government showed the number of the inhabitants to be 953,243. The island has probably more than one million people to-day. The population is engaged almost exclusively in agriculture and in the primary manipulation of agricultural products. The extraordinary fertility of the island will, for many years to come, cause the attention of all investors to be devoted rather to agriculture than to manufacture.

Immigration is slight. It is made up chiefly of the natives of the Danish island of St. Thomas and of the British West Indies. The immigrants usually go into the ranks of unskilled labor and form a desirable element in the community, being for the most part industrious and intelligent. They are to be found in greatest abundance in the towns on the seaboard.

The demand for labor is steadily increasing and the payment of labor is rising. As the agricultural resources of the island are developed year by year the island will be able to support a larger population.

Corporal punishment in the public schools is forbidden. Such a practice is extremely distasteful to the inhabitants of the island who are, invariably, gentle in their treatment of children.

Under our laws murder in the first degree is punished by death.

Porto Rico is forging ahead in every line. Its exportations during

the present fiscal year will be nearly three times the value of its exportations during its most prosperous year under Spanish government. Increase in prosperity, with the resulting increase in insular revenue, has enabled the government to build twice as many kilometers of roads as were built during the four centuries of Spanish occupation, and the building of new roads results again in an increase in prosperity. The school attendance is about twice what it was in Spanish times. Crime has diminished. The expert knowledge of public and private sanitation has been spread throughout the island. The administration of justice has become swift, certain and unstained. The intercourse between the island and the outer world has enormously increased.

Still we need more roads and more schools. In a mountainous country like this, with a heavy rainfall, when we build a road we must build a good one, and we must keep that road in good condition after it is built; otherwise the money is wasted. The building and maintenance of roads in Porto Rico is extremely expensive, but they must be built and they must be well maintained so that the crops of the mountain valleys can be brought easily and cheaply to the seaboard. Moreover, we need more schools. We have built schools and have increased school attendance, but we have not enough schools yet.

PUBLIC CARE OF THE POOR IN EARLY AMERICA

Accurate Transcript from Records of Watertown, Massachusetts

BY M. AUGUSTA HOLMAN, LEOMINSTER, MASSACHUSETTS

At a meeting at Lelft. Beers, March 3, 1671. There coming a complaint to us ye Selectmen concerning ye poverty of Edward Sandersons family yt that they have not had wherewith to maintaine themselves and children either with suply of provisions or employment to earne any—And considering yt it would be ye charge of ye towne to provide for ye whole Family which will be hard to doe this year, and not knowing how to supply them with provisions, we considering if we should supply them, and could doe it, yet it would not tend to ye good of ye children for their good education and bringing up, soe as they may be useful in ye common weal, and themselves to live comfortable and usefully in time to come, We have therefore agreed to put two of his children into some honest fameleys where they may be educated and brought up in ye knowledge of God & sum honest calling or labor, And Therefore we doe order that Thomas Fleg (Flag) and John Bigulah (Bigelow) shall have power to find them prentises, with sum honest people with ye consent of their parents, if it may be hade, and if ye parents shall refuse then to use ye help of the magistrate.

Resources of the Great Northwest

BY

HONORABLE JOSEPH TOOLE, GOVERNOR OF MONTANA



ALTHOUGH the date of the erection of the first building in what is now the State of Montana goes back almost a century—when Emanuel Lisa in 1809 or 1810 built what became known as Lisa's Fort on the Yellowstone river—it was half a century later that the eyes of the outside world were directed to this portion of the wilderness lying west of the Mississippi.

The gold-hunters, those hardy old pioneers whose restlessness ever drove them nearer the setting sun, lured on by the belief that the mountains of this almost unexplored land held splendid reward, pushed their way across the plains and soon the magic cry "Gold!" was carried back to the East, whence other restless spirits set out for the journey to the Rockies.

In the latter fifties and the early sixties the mining excitement served to bring thousands of people into what is now Montana. Southern Montana was the scene of the early excitement, and here, in the hurriedly-built town of Bannack, was set up the first government, when the Territory of Montana was organized, in the year 1864. Other camps sprang up as new deposits of the

precious metals were discovered, and the infant Territory rapidly grew into a lusty youth.

The growth of Montana continued as the mines gave up their hoards, the ranges became alive with cattle and sheep, and the earth, untilled for centuries, began under the hand of the agriculturist to demonstrate that it gladly yielded abundant harvest to him who would toil for it—and at last Congress heard the appeal of the people for Statehood, Montana becoming one of the States of the Union on the eighth of November, 1889.

To-day the population of the State is estimated to be more than 250,000, and although its growth is not marvelously rapid it is healthy and steady. Its mines have been wondrously productive—the output of copper alone in the last year being forty per cent of the total for the United States. It is the greatest wool-growing State in the Union, its total of sheep for 1906 being 4,304,333. Its herds of cattle for the same year contained a total of 823,721 head.

And despite this wonderful showing, it is believed to be well within the limits of truth to say that in the years to come Montana will find its rank among the greatest agricultural States of the nation. It has millions of acres of fertile lands that require only the application of water to cause

Resources of the Great Northwest

them to yield immense returns. This result is gradually being attained by the establishment of irrigation projects under Federal and State encouragement, and the next ten years will undoubtedly see the reclamation of a vast area.

Montana has no vexed problem of capital and labor; the people are patriotic, public-spirited and progressive, and they bend eagerly to their cherished task of making of their commonwealth one of the grandest in the magnificent sisterhood.

Opportunities in the Northern Borderland

BY

HONORABLE E. Y. SARLES, GOVERNOR OF NORTH DAKOTA



NORTH DAKOTA is one of two states created out of the original Territory of Dakota, which was organized as a territory on March 2, 1861. The employees of various fur companies were the first white settlers in the territory. As early as 1808 the government established a military fort on the Missouri river about seven miles above the point where Lewis and Clark spent the winter in 1804 and 1805. In 1811 Lord Selkirk built a fort at Pembina on the Red river not far from the international boundary line.

North Dakota became a state in 1889. Its population has increased largely in the past two years until to-

day it has in the neighborhood of half a million people. The occupation of its people is largely agricultural and pastoral. It has received many immigrants in the past two years, largely of the Scandinavian and German types, and its immigration is a thrifty class, which is engaged altogether in agricultural pursuits.

The citizenship of North Dakota is sturdy, patriotic and thrifty. Its laws are wise, liberal and beneficent and abreast of the times in all particulars. Its public servants have been patriotic and have labored incessantly for the advancement of the state. It offers homes to thousands of additional settlers and it has splendid advantages and opportunities for the thrifty homemaker.

The First American Novelist

Experiences
of the First Writer
in the New World to make Literature
His Sole Pursuit and to Earn a Livelihood by His
Pen & The First American Fiction to Create a Literary Market
was "Wieland," a Tale of Mystery & Career of Charles Brockden Brown

BY

ELLIS PAXSON OBERHOLTZER, PH. D.

AUTHOR OF "ROBERT MORRIS, PATRIOT AND FINANCIER"—EDITOR OF THE "AMERICAN CRISIS BIOGRAPHIES," AND OTHER WORKS—THIS RESUMÉ OF THE LIFE OF CHARLES BROCKDEN BROWN, THE FIRST AMERICAN NOVELIST, IS PRESENTED BY PERMISSION OF THE AUTHOR FROM HIS "LITERARY HISTORY OF PHILADELPHIA," PUBLISHED BY GEORGE W. JACOBS AND COMPANY, A NOTABLE CONTRIBUTION TO AMERICAN LITERATURE

THE first American novelist—the first writer of fiction to achieve eminence in this country, and the first writer of whatever kind who had the daring to make literature his sole pursuit—was Charles Brockden Brown. It is certain that none before him in this country had done so well; none produced fiction that the public read so eagerly and appreciatively. He lived by his pen, a hurried, fitful and brief life, it is true, but starve at the end he did not. He came of an old Chester County, Pennsylvania, Quaker family, respectable but not eminent, having been born in Philadelphia on January 17, 1771. He was named for Charles Brockden, the well-known conveyancer and agent for the Penn family in Philadelphia who married his father's sister. From this writer is the taste for triple names among American authors sometimes derived. With him at least the multiplication of cognomens seemed to be a necessity, for he clearly understood that the odds were as unfavorable to the Browns as they were to Oliver Wendell Holmes' hero whom fate tried to conceal under the name of Smith. Once when a friend had done him the honor of giving him a namesake, Brown expressed his regret that the infant was not to

have a greater chance for the distinctions of life. "It has ever been an irksome and unwelcome sound to my ears," said he. "I have sometimes been mortified in looking over the catalogue of heroes, sages and saints to find not a single Brown among them. This indeed may be said of many other names but most others are of rare occurrence. It must then be a strange fatality which has hitherto excluded it from the illustrious and venerable list."

For about five years Charles Brockden Brown attended the Quaker school of Robert Proud, the historian, but, frail of build, confinement and application jaded him. He was designed for the law but the prospect of that life was repellent. He loved solitude, especially rambles into the country. The talk of the world about him wearied him with its frivolity. His enthusiasm was for thinking and writing, and essays, verse, dialogues, fanciful sketches and a journal were produced while he was still at school. He was the leading member of the little Belles Lettres Club of nine members, and though he was contributing to the "Columbian Magazine," he was painfully impressed with the hopelessness of earning a livelihood from literary pursuits. His parents, his three older brothers, Joseph, James and Armit, and his friends were all

First American Novelist and His Books

disappointed that he had left off his law studies, and until his first literary success was achieved in "Wieland" in 1798, he was at times plunged in the depths of despondency. He visited New York, and was there the guest of Dr. Elihu Hubbard Smith whom he had come to know as a medical student in Philadelphia. Smith introduced the young writer to a group of professional and literary men who received him cordially. These visits were frequently repeated. For a time New York was accounted his home, and his attachment to his friends in that city almost cost him his life during the fever plague of 1798. Throughout this time, by his own account, he "mused and wrote cheerfully in spite of the groans of the dying and the rumbling of the hearses."

In Philadelphia in 1793 Brown had escaped the dangers of the disease by removing with his family to a place of safety in the country. While in New York he had spent several summers at Perth Amboy with his friend who was later his biographer, the artist and dramatist, William Dunlap, but in 1798 he tarried in the city with Dr. Smith. A distinguished Italian traveler, Dr. Scandella, after many adventures, which read as if they were drawn from one of Brown's novels, was seized with the malady, to be taken into Smith's home. The Italian soon died. Dr. Smith followed him to the grave and Brown, who was a nurse for both, also fell a victim to "this most dreadful and relentless of pestilences," but by good fortune his case yielded to treatment, and almost immediately after this dread experience he was invigorated in body and spirit by his first literary success.

"Wieland" was published in New York, although its scenes are laid in Philadelphia or its environs, and it met with instant popularity, so that its author was encouraged to wield his pen with new energy. He had

five novels in progress at the same time. Such literary activity had not been seen before in America. Some were being written while others were printing; some were just begun while others were nearing completion. "Ormond," which closely followed "Wieland," was less successful, but "Arthur Mervyn," the yellow fever story which appeared in two parts, was a sweeping popular triumph. The first part of this work was published in Philadelphia with the printer Maxwell. The manuscript was delivered as fast as it was written, and before Brown had yet determined his plot. The publisher, however, proved to be too dilatory for the eager author, who was obliged to make allowances "for his indigence on one hand and his sanguine and promiscuous disposition on the other." Brown's quill was busy from eight in the morning until eleven at night, and if he remembered the names of his characters in his various novels as each progressed under his hand and he moved from one to another, it was a fortunate circumstance.

"Edgar Huntley," his somnambulist story, followed "Arthur Mervyn." Then came "Clara Howard." Here are five works of fiction, all of which appeared inside of three years; three were issued in one year. All were written before their author was yet thirty. With a sixth story, "Jane Talbot," which was published in London in 1804, appearing soon afterward in Philadelphia, Brown's career as a writer of fiction ends. Upon these six works his title to literary reputation rests. Yet inside the covers of his half-dozen novels is to be found but a small part of all that was written by this remarkably productive author.

While his stories were appearing, Brown was busy with his New York magazine. Eight of his friends in that city had pledged themselves for a sufficient amount to insure its success. He called it "The Monthly

Father of the Literary Trade in America

Magazine and American Review," and the first number appeared in April, 1799. He contributed almost the entire volume of what was published in this periodical and at first had from it enticing prospects of fortune. There were four hundred subscribers, which it was computed would repay the annual cost of issue, or \$1,600. "All above four hundred will be clear profit to me," he wrote to one of his brothers, and one thousand subscribers, he calculated, would yield him a net annual income of \$2,700. His hopes were not realized, and at the end of the year, 1800, the publication ceased, the editor returning to his home in Philadelphia.

In his own city Charles Brockden Brown was not long to dwell in literary idleness. He was now writing political pamphlets. He made an arrangement with John Conrad, a publisher in Philadelphia, for a new magazine, "The Literary Magazine and American Register." At the time it was founded, in October, 1803, there was no other monthly publication in America and the way looked clear before it. The editor in his salutatory said: "I cannot expatiate on the vanity of my knowledge, the brilliancy of my wit, the versatility of my talents. To none of these do I lay any claim." But it was his hope "to collect into one focal spot the rays of a great number of luminaries." It would be his province "to hold the mirror up so as to assemble all their influences within its verge and reflect them on the public in such a manner as to warm and enlighten."

In enlisting the co-operation of other writers, Brown had no great success. In one number nothing was contributed but a short article; everything else was from the editor's own hand. There was no gayety in this publication, for Brown had none. Nevertheless, the magazine was continued for nearly five years.

In 1806 he began to compile for the same publishing house his "American

Register or General Repository of History, Politics and Science," an annual review of the world's happenings in different fields which was issued for five years (1806-1810 inclusive), a large volume and sometimes two volumes for the year. It was published until its editor was obliged to surrender to his disease.

Consumption for many years had been his arch enemy. He had traveled hither and thither in vain in the hope of strengthening his weak, pale frame, and when the attack from which he was not to rise came, in November, 1809, his friends were urging him to undertake a journey to Europe, though it was against his inclinations. In that year he wrote to a member of his family: "When have I known that lightness and vivacity of mind which the divine flow of health even in calamity produces in some men? And would produce in me no doubt; at least when not soured by misfortune? Never, scarcely ever. Not longer than an half hour at a time since I have called myself man."

His only consolation was found in his books which for him, he said, had "great efficacy in beguiling body of its pains and thoughts of their melancholy, in relieving head and heart of their aches." He died on February 22, 1810, at his home in Eleventh Street near Chestnut when only thirty-nine years of age, being interred in an unmarked spot in the Friends' burial ground at Fourth and Arch Streets.

While choice of his fellows, few more fully enjoyed those intimacies which were contracted. Although not adhering closely to Quaker tenets, to his Quaker friends he used his "thee" and "thy" as one to the manner born. He had a brief period of domestic bliss, for while in New York he met, wooed and won for a wife Elizabeth Linn. She was the daughter of Dr. William Linn of Shippensburg, Pa., once the president of Rutgers College, and at the time a distinguished

First American Novelist and His Books

Presbyterian clergyman in New York. The young novelist and Miss Linn were married in November, 1804, and she came to make her home in Philadelphia where her brother, Dr. John Blair Linn, also a minister, had been preaching in the First Presbyterian Church until his death of consumption in the preceding August. He had been Brown's intimate friend and was a writer of verses, one of which, an epic called "Valerian," the novelist edited and published with a memoir.

Although Brown was to have little more than five years of married happiness, he left four children, three boys and an infant girl. Two were twins of whom he wrote when they were born: "I was always terribly impressed with the hardships and anxieties attending the care of infants and was at the moment appalled by the prospect of a double portion of care. . . . Now after two months' experience I find, and their mother finds, that the two healthy and lovely babes are a double joy instead of being a double care."

The final judgment on Brown's work may not yet have been uttered, but it is not difficult now to assign his novels to their proper place. They must be considered in the light of the time in which they were written when they will be accounted to have a great deal of value in spite of crudities and imperfections that are obvious to all who dip but a little way into them. They are the work of a writer of unbridled imagination. In a few pages there are exciting incidents enough to serve a novelist of this day for an entire volume. Lust, intrigue and multiplied mystery testify to a fancy as fecund as that of the Sultana who saved her head by relating the tales of the one thousand and one nights in Arabia.

Philadelphia in Brown's hands at once became a king of Bagdad. Marvelous houses with winding stairways and dark basements, dead men who

come to life, voices in closets, lights that strangely disappear, treasure found and lost with much seduction, suicide and murder make up a record which contains suggestions for a generation of story writers. If the plots could be rid of involution, they would be enjoyed by the bad boys of our day. The reader is carried headlong from one startling situation to another until he is mentally fagged, although compelled to read on, in the end viewing with wonder the singular flow of the author's imagination.

An impression is created of a mind too full of possibilities of strange complications for convenient arrangement and utterance. Probability is taxed to its limits, although his friends assert, when they compare his work with that of other writers, that these bounds are never passed. The narrative proceeds in short, tense, direct, high-strung sentences, striking with the force and regularity of a trip-hammer. Of charm of style his readers will acquit Charles Brockden Brown. Of niceties of language or care in the arrangement of his ideas there is almost total lack. Of humor or epigram there is none. Dialect is used only awkwardly, and the characters talk in an unchanging monotone. Indeed, dialogue is little resorted to by Brown in his story-telling, and there are pages and chapters of statements and confessions unrelied by quotation marks. The narrator, who uses the first person, changes from time to time, and only close and continued attention discloses the identity of the speaker. The most marked defect in Brown's work, however, is his failure to make use of all the material which he so lavishly spreads out before us as his story proceeds.

"Wieland" errs principally through the artificiality of the devices employed to create the tissue of mystery of which the tale consists. Two ideas are utilized, the principle of "self-combustion" by which the elder Wie-

Father of the Literary Trade in America

land, the German mystic who has a temple of prayer somewhere on the banks of the Wissahickon or Schuylkill, is consumed; and ventriloquism, an art then new, by which a man for no sufficient motive induces the younger Wieland to murder his wife and children.

The great defect of "Arthur Mervyn," on the other hand, is the introduction of episodes that are forgotten by the author in the later development of his plot. In the end he has two interesting heroines whose fate remains to be explained. They are suddenly abandoned for a third. It is plain that the author changed his plans again and again as his work progressed under his hand. These faults arose from the fact that the printer literally stood at his shoulder while he wrote, after "Wieland" had whetted the public taste for his stories, and the manuscript could not be revised. Such speed was fatal to art as it was to Brown himself.

The facts remain that "Wieland" is an absorbing tale of mystery, while "Arthur Mervyn" is more; it is in its first part an historical document ranking with Dr. Rush's and Mathew Carey's writings as a truthful delineation of the peculiar horrors of the yellow fever plague of 1793 in Philadelphia. Of his description of the scene between Welbeck and Mervyn, when the latter burns up \$20,000 in notes, Brown subsequently wrote to his brother that "to excite and baffle curiosity without shocking belief is the end to be contemplated. I have endeavored to wind up the reader's passions to the highest pitch and to make the catastrophe in the highest degree

unexpected and momentous." This in short was the guiding principle of Brown's life as a novel writer, and that he succeeded in spite of defects which it is easy to see and criticise, is his title to a national and international place in literature.

It is impossible to find a measure of the circulation of his books or of the profit that accrued to him as their author. However, it cannot have been large for he wrote to his brother Joseph in 1800, after his second successful book had appeared: "Seldom less happy than at present; seldom has my prospect been a gloomier one. Yet it may shine when least expected."

Again he wrote in the same year: "Book-making is the dullest of all trades and the utmost that any American can look for in his native country is to be reimbursed his unavoidable expenses." At his death, his wife conducted a boarding-house to sustain herself and her children.

Thus the novel was established in America by an undoubted literary genius, but on foundations too hastily and too carelessly built. His own physical wretchedness, his penury, his temperament that caused him to work with unparalleled rapidity—all conspire to cast discredit upon his art and make his achievement seem vastly smaller than it might have been under more favorable circumstances. But blemishes may be forgot in the presence of such a creative faculty, and though the reproach be fairly his that his novels are not read to-day, it is no conclusive argument against an author whose place has long been secure in our gallery of literary men.

FROM THE INTERNATIONAL BIBLIOGRAPHICAL INSTITUTE IN BRUSSELS

Since the invention of printing to 1907, there have been published in the world 13,063,000 books. Of these 29.42 per cent are legal and sociological works, 20.46 literary, 12.18 scientific, 11.44 historical and geographical, 10 theological and religious, 9 per cent bibliographical, 2.62

artistic, and 1.36 philosophical. Of the periodical publications of the present time it is estimated that 48 per cent are in the English language, 23 in German, 11 in French, 6 per cent in Spanish, 2 per cent in Italian, and 10 per cent in other languages.

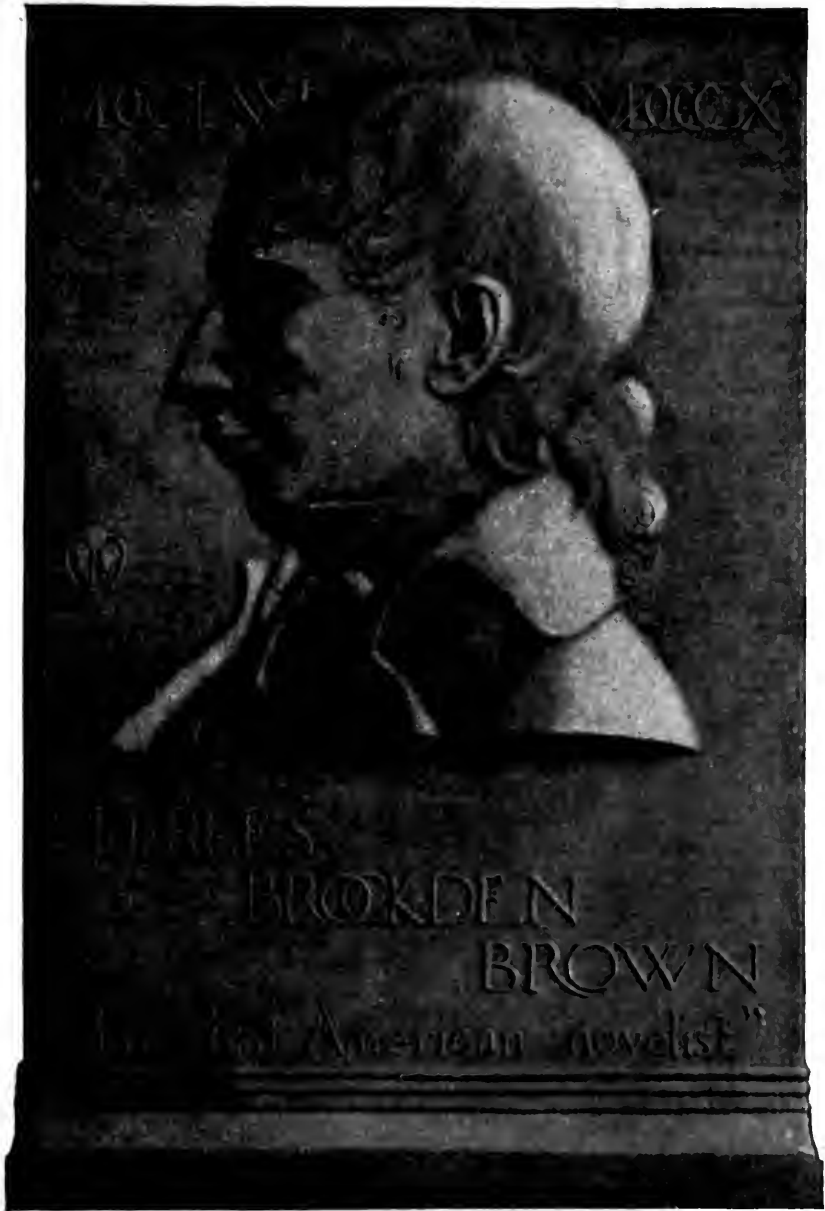

BRONZE BAS-RELIEF

BY DR. R. TAIT MCKENZIE OF PHILADELPHIA

FOR THE FRANKLIN INN CLUB

240a

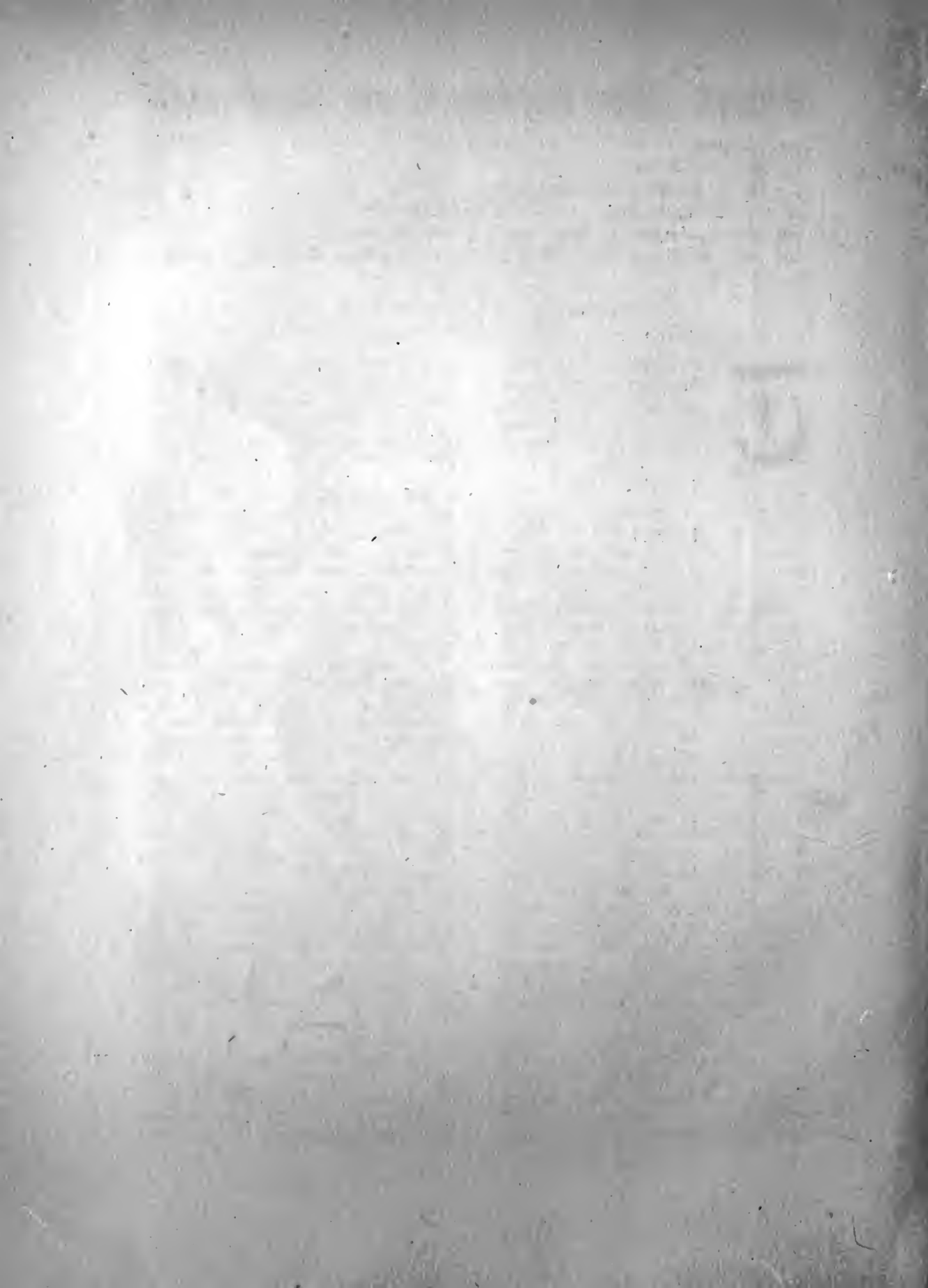

First Physicians in America

The Customs
and Practices of Early
Doctors as Revealed in Correspondence
of John Winthrop, Born in 1606 * Dutch, Quakers
and Puritans Consulted Him regarding their Physical Ills *
The New World was Full of His Praises * Beginning of American Medicine

BY

WALTER R. STEINER, M.A., M.D.

FORMERLY HOUSE MEDICAL OFFICER IN THE JOHNS HOPKINS HOSPITAL AT BALTIMORE, MARYLAND

THE experiences of John Winthrop, junior, one of the first physicians in America, is a most interesting narrative. When one considers that a "doctor's" patients were scattered in a wilderness, through which roamed wild beasts and wilder men, it is indeed remarkable that the pioneer Americans ever recovered when once seized with disease.

When the pioneer Americans were taken sick it many times meant a daring ride through the forests, with possible encounters with the Indians, and it might be a day, or two days, and very probably a week, before the messenger returned with the "prescription."

While Winthrop was one of the earliest physicians in America he was not the earliest. There were a few physicians in early Virginia. Dr. Thomas Wotten, surgeon-general of the London Company, sailed from England for Jamestown on December 19, 1606. Dr. Walter Russell was another of the little band who came to Virginia. In the early annals of New York, Hermain Mynderts Van de Bogaerdet arrived as a surgeon on the ship "Endragle" in 1631, and William Deeping on the ship "William of London" in 1663.

It is through Winthrop's experiences, however, that one gets a clear insight into the beginning of medical practice in America, with an inkling of the "popular" diseases of the times and their remedies. The investiga-

tion here recorded was originally read before the Johns Hopkins' Hospital Historical Society and presented in the Bulletin of that institution. It is now authoritatively given, with some revisions, for the public at large.

The early Americans were fortunate in having the services of men of the character and ability of John Winthrop. His "qualities of human excellence were mingled in such happy proportions, that, while he always wore the air of contentment, no enterprise in which he engaged seemed too lofty for his powers."

He was born in Groton Manor, England, February 12, 1606, and was educated at Trinity College, Dublin, and studied law at the Inner Temple. He entered the English naval service, sailing with George Villiers, the Duke of Buckingham, and perfected his education by visiting, in part, at least, in the public service, not Holland and France only, in the days of Prince Maurice and Richelieu, but Venice and Constantinople.

Traveling in Europe "he sought the society of men eminent for learning. Returning to England in the bloom of life, with the fairest promise of preferment, he preferred to follow his father to the New World, regarding 'diversities of countries but as so many inns,' alike conducting 'to the journey's end.'"

The New World was full of his praises; Puritans and Quakers and the freemen of Rhode Island were alike his eulogists; the Dutch at New York had confidence in his integrity.

First Physicians in America—Their Customs

THE long life of this pioneer American physician, John Winthrop, makes a unique chapter. He followed his father to this country in 1631 and was shortly thereafter made an assistant in the Massachusetts Colony. A year later he led a company of twelve to Agawam (now Ipswich), where a settlement was made. In about a year he returned to England and received a commission to be governor of the river Connecticut for one year. On coming back to America he built a fort at Saybrook, Connecticut, and resided there part of that time. Then, making no effort to have the commission renewed, he returned to Ipswich and became one of the prudential men of the town. Subsequently he moved to Salem, established some salt works there, made another trip to England, and finally receiving Fisher's Island as a grant from the General Court of Massachusetts, went there in the fall of 1646. This grant was subsequently confirmed by both Connecticut and New York. In the spring of the following year he removed to Pequot (now New London), but, after a residence of eight years, moved to New Haven. From here he was called to dwell in Hartford on being elected governor of Connecticut in 1657. He had previously (September 9, 1647) been given a commission to execute justice in his town (Pequot) "according to our laws and the rule of righteousness," and in May, 1651, was elected an assistant of Connecticut. He served as governor one year, then became deputy governor on account of a law which prevented his re-election. This law being repealed the next year, he served continuously as governor from 1659 till his death in 1676, although in 1667, 1670 and 1675 he requested to be relieved of this office.

From his youth he was devoted to scientific studies and was an omnivorous reader of books. Alchemy

greatly interested him and among his correspondents were numbered Dr. Robert Child, Sir Kenelm Digby, George Storkey and Jonathan Brewster, all of whom had like ties. He was also much attached to astronomy and with his telescope, which was "but a tube of 3 foote and a half with a concave eye-glasse," he was able to see five satellites of Jupiter and make other celestial observations. He was distrustful of having seen five satellites as Galileo and others had only observed four. He seemed to enjoy especially the association with scientific men. In 1661, when he went to England for a third time, he arrived not long after the Royal Society for Improving Useful Knowledge was organized. It was first organized in 1660 but was not incorporated until two years later. On December 11 of that year he was proposed for membership by William Brereton, afterwards Lord Brereton, and was admitted January 1, 1662. During his stay in England, which continued till the early summer of 1663, he took an active part in the society's proceedings, read a number of papers on a great variety of subjects, and exhibited many curious things. Some of his papers during this period were on strange tides, the refining of gold, the making of pitch, tar and potashes, the building of ships in North America, and the brewing of beer from maize bread. Among the things he exhibited were a self-feeding lamp, of his own invention, malleable mineral lead, piece of a rock of granite, bluish grains of corn grown in the West Indies, and the tail of a rattlesnake.

He came naturally by his liking for medicine, as his father had no mean knowledge of this science. In a letter his father wrote, on the occasion of his son's illness at Ipswich, he speaks of drugs and remedies which show him to be well acquainted with them. The venerable Cotton says that the elder Winthrop had been a "Help for our Bodies by Physick, for our Estates by Law." This bent

A Doctor's Correspondence With His Patients

toward medicine existed in other members of the family also, for we learn Winthrop's brother Henry's widow "was much employed in her surgyre and hath very good succeſſe," and his son Wait and grandson John had both a laudable knowledge of medicine for their times.

At this period the offices of clergyman and physician were frequently associated in one individual—instances of what Cotton Mather has called "the Angelical Conjunction," the cure of body combined with the cure of soul. This association may largely have been due to the survival of the custom of the dark ages when the priests were considered the repositories of learning and held both of these offices. There is, however, an additional reason in the fact that medicine alone was not very profitable at this time, so we find some turning also to divinity, as Giles Firmin, who "previously did make and read upon the one Anatomy in the countrey very well." In a letter still preserved he says: "I am strongly sett upon to studye divinitie: my studies else must be lost, for physick is but a meene help."

"The scarcity of physicians in the Colonies and Winthrop's willingness to give advice free of charge—so far as his studies enabled him to do so—caused him to be much consulted." Connecticut, Massachusetts and Rhode Island were the territories in which his patients mostly lived. They were frequently sent to him, generally at Pequot or Hartford, but at times he would come to see them in consultation with the village doctor, or otherwise, when they were too sick to be moved. Some were also treated by him by letter, without personal inspection. Cotton Mather says: "Wherever he came, still the Diseased flocked about him, as if the Healing Angel of Bethesda had appeared in the place."

From his papers, which consist mostly of letters addressed to him, I have been able to glean something re-

lating to his career as a physician. In all I have collected over one hundred medical references.

His first patient appears to have been his father, who in some way had injured his finger. On April 11, 1628. Winthrop writes his father that he is sending some yellow and black plasters which were given him by a woman "that is very skilful and much sought unto for these things." Directions for their use accompany them. At the end of four days his father says: "I prayse God my finger is well amended, my surgeon did his parte well, and stayde the gangrene and tooke out the mortified fleshe, but because your love and peines should not be lost I have betaken myselfe wholly to your plaister wch the Surgeon likes well enough; and I prayse God it goeth well forward." Some years later, in 1637, Winthrop's wife seems to have swallowed some pins. We do not know what means were employed to relieve her, but his father writes him a letter expressing great gratification that the wife had been delivered from so great a danger. He adds: "I hope it will teach my daughter and other women to take heed of putting pins in the mouth which was never seasonable to be fed with such morsels."

Besides these references we find many others which show the esteem in which his family held him for his medical knowledge. Winthrop's father-in-law, Hugh Peters, writes from Salem, saying: "My head is not well, nor any part at present, for I cannot get sleepe. I would you should send mee word what you will doe therein but rather come over" (from Ipswich). He later speaks of his old malady of the "spleene" and says: "I never had hart or tyme to attend any cure, that I now give my life gone; and shall not live my parts I feare." How little did he then know of the truth he was telling, for in eleven years he was executed as a regicide, at Charing Cross, on October 16, 1660! Winthrop's brother-

First Physicians in America—Their Customs

in-law, Samuel Symonds, was a prominent man in Ipswich, and finally became deputy governor. In 1647 he states that his wife's indigestion is better and adds: "Good wine (as you say) is the best cordiall for her." In a later letter he mentions his daughter having received some physick from Winthrop and being benefited by it.

Eight years prior to this last communication, in 1641, Winthrop's aunt, Lucy Downing, from London, tells him she has "experimented the cros this 2 nights, and found much though not a totall freedom of payne thereby." Other letters follow this one about her various ailments. One written January 17, 1661, possesses some interest and causes us to wonder what she really had. She says: "I was taken with a veri sore paine one my leaft side wich at betwickst my short ribs and my buckell boone; and the paine being so sharpe, it was feared to have been plurisi, but wen the dockter came he said it was not a plurisi but he judge it to be the stonne in the kidney, and thereupon did apli mani thing both inward and outward to remove the paine; the extremiti there of did put me into a very feaverish condishion, and to or thre fits of a fever, and then i was pritti well recovered; but retern by a little could, but I relapsed in to another of those fits, and then i tried hot brikes to my side, and bages of fried oats, and up on the use of them i found the paine did much mittigate, and then i sent to the dockter, and he sent me a plaister wich i found, the same night i laide it on, it did much dispers the paine all aboute my bodi, and the neckst morning i found my seulf much better than formerli, and both my stomak and by weast are much better then of aweake before, but am still verri tender, and forst to kepe my chamber; but i have veri good hopes that the p'aister may be a means to prevent such extremity for the futurr, and the dockter now thinkes it was some

other trouble and not the stone." She forbare sending for Winthrop as she got some ease and hopes of recovery. It is well to state that she employed an amanuensis, so we must not blame the old lady for this spelling. Two years before Winthrop's death she was still living, although well on in years. She then mentions her increasing deafness, states that she had consulted two doctors for it and that they both agreed "the more she did tamper with her ears the worse it might be for her." She is "not willing consequently to a further hazerd of her ears and her mony allso for nothing."

Winthrop's niece, Hannah Gallup, writes to him on two occasions. At one time she wishes a litle phisicke and some directions for a "disease much like the fluxe." In the other letter he is thanked for the "Physik and other kindnesses." Stephen and Samuel, Winthrop's brothers, also, occasionally write to him about matters medical. The former, who served in Cromwell's army and Parliament, informs Winthrop, August 2, 1653, that he has been "this two years extremely troubled wth the Zeatica, and am just now going to the Bath to see if yt may remedy it. My much lying in ye wet feilds uppon the ground hath brought it uppon me, as it hath uppon many others."

Wait, Winthrop's younger son, frequently writes to him on medical topics and often he gets his advice as to treatment. In 1671, he wishes some directions for "convulsion fitts in children, they being often troubled with them here (Boston); also for Mrs. Mary Maning for her old distemper, which you have given her something for formerly." On other occasions Wait buys various medicines in Boston for his father such as opium, jalap, "vitriolum album," ivory, and aloes. Once Wait wishes his father to send some black powder to him "if ther be oportunity, and you have any quantitye made. I am

A Doctor's Correspondence With His Patients

almost out, and have not conveyence to make any presently."

But aside from attending to his family's ailments he had many professional obligations to perform as the most prominent men of the colonies, as we shall see, consulted him frequently in cases of sickness. His duty to a patient caused him to forego, at one time, the pleasure of meeting Francis Lovelace, the governor of New York, at Milford. He was obliged to express his regrets for "he was engaged to a deare friend not long before, who was at the very Agony of death (as was feared by all then present there) not to be absent till an apparent recovery, wch then was doubtfull, but now (god be praised) is in a good measure attained, but there were reasons to think it might not have beene so, if I had been fro home."

Elder Goodwin of Cambridge, Hartford, Hadley and Farmington thanks him for attending his wife and child, and declares success crowned his endeavors in regard to the treatment of the former and wishes as "the water she used is all spent," that "the ingredients and direction how to use it" be sent them; "for we are very loath to breake ofe the use of such meanes as God hath been pleased to make so usfull to us in this case." "His daughter was afflicted with the palsy and did not seem to be benefited by the treatment." In a subsequent letter we learn that the water was for Mrs. Goodwin "to wash her leg with all" and more powder was desired to make it up "for she fyndeth more reliefe and ease of her greife by that meanes than by any other she hath formerly had the use of." The daughter does not seem to have improved.

John Higginson, then assistant to Henry Whitfield, the pastor at Guilford, Connecticut, writes a most earnest letter to Winthrop, at Pequot, in 1654 or 1655, begging him to come and see his wife. Higginson does

not say what her sickness was but declares "the case is such as cannot be judged without ocular inspection." He calls it "a very sad affliction, she being in a very dangerous case as Mr. Rosseter (the village doctor) and all our neighbors here doe apprehend." He hopes that Winthrop's "counsel and help, together with Mr. Rosseter" may be the means of preserving her life, "if so it pleas the Lord."

John Mason, rendered famous by the Pequot War and subsequently major-general, commander-in-chief of the military forces of Connecticut and for eight years deputy governor, writes several letters expressing appreciation for physick and services rendered to his wife who "as yet remaineth ill, yet sometimes a little reviving, with the addition of somewhat more strength."

Thomas Mayhew, governor of Martha's Vineyard and Nantucket, as well as preacher to the Indians there, though bowed down by over three score and ten years, cannot refrain from rendering his thanks for Winthrop's "readiness in sending that powder for my grandchild together with advice." I will speak of this again in referring to Winthrop's sovereign remedy Rubila. Mayhew, agreeing with Higginson as to the value of ocular inspection, wishes to know if Winthrop is willing "shee should com to Conectacut, where shee may be neare yow, and also the sight of hir may much more informe your judgment touching her disease." Subsequently Mayhew mentions an attack he had of what may have been appendicitis. He states the "paine I had seised one me in the morning betyme, upon the right syde; the paine was not so broade as the palme of my hand. It was like to take me of the stage, but it went away in my sleepe that night; when I awoke, I was altogether free of that paine and of other sore paine which came uppon me in using menese by a glystr to free my sellfe of that." His last let-

First Physicians in America—Their Customs

ter, written less than a year before Winthrop's death, tells us that one of his grand-daughters had used the physick sent with success but the little ones had not taken any and we wonder if Rubila was not the remedy employed.

Captain John Underhill, of Long Island, heretical, eccentric and illiterate yet firmly convinced that God has made Winthrop "an instrument of the gud of mani diseased," desires relief for his wife "whom dayli continnuse in gret payne, resefing last yere a payne in her back with alift of a wayti stone and dayli increses her payne, and desense in to her left hip, so that shee can not torn her in bed, no gooe up rit in the daye." And again he wishes Winthrop to help "a gud godli woman, and diere frend of my wife" whose distemper "is as a shouting agew, pricking in her left side, asending into her temples, and tieth, hed and jase, and takese her sometimes too dayse together and hase had it niere 12 months, with such extremity as shee can not rest nigh [t] nor daye, and takes her at aell sesones, night and daye, shifting his course as an ago." He also hopes Winthrop will send his wife a "littil whit vitterall."

Roger Williams, the ardent Quaker and founder of Rhode Island, was long one of Winthrop's correspondents. In 1649 he writes about his daughter, aged seventeen, who had "taken much physick and bene let blood but yet no change, she is advised by some to the Bay: I pray advise me to whom you judge fittest to adresse unto of the Bayes Physitions." At another time he speaks of his son troubled "with a spice of an epilepsie;" "We used some remedies," he says, "but it hath pleased God by his taking of tobacco perfectly (as we hope) to cure him." Mention of Williams will again be made when we discuss Rubila.

Winthrop's "loveing freind." George Hethcote, from far off Bar-

badoes asks for something in 1669 "to stop the groweth of consumption." His mother had previously told him he had it, but he put, unwisely in this case, more confidence in his doctor, who informed him to the contrary. He goes on to add "I am much troubled with a thin sharp salt youmer that settles uppon me longes and causes me to spitt much and sune time cough but seldom—that powder I had of the for the spittinge did me much good." He wishes, consequently help in medicine and diet so that "the cause and ground of the consumption may be taken away if the Lord see good." Possibly also about this time John Tinker appealed to Winthrop on behalf of his servant, who was injured "by reason of a little stike run into his head through the hole of his eare." "We know not what to do," he declares, "I intreat your worships advice."

Samuel Gorton of Rhode Island, "turbulent in disposition," and so constituted that "every community wherein he cast his lot was anxious to get rid of him," but now tamed by his four score and two years, writes to Winthrop on August 11, 1674, of his "sore infirmite and distemper which hath held him now almost a whole moneth of dayes." A month later, with a heart full of thanksgiving, he pours forth his rejoicings to Winthrop in a letter which takes up twenty-five octavo printed pages. The "cordiall and soveraigne powders" Winthrop had sent had so done their work he finds his body "to be little differing from that which it was, before the distemper seized" upon him. Also another "infirmite" which was a "benumbednesse or like the crampe" is taken away. He wonders consequently "that a thing so little in quantity, so little in sent, so little in taste, and so little to sence in operation, should beget and bring forth such effects."

Edward Wigglesworth, a minister of the gospel, thinking he strained

A Doctor's Correspondence With His Patients

himself when being hot he "tooke a lift" on a cold day in the winter, desires medical aid. He states some months after the accident "when I looked upyards being ready to fall backwards, and when I looked downward, to fall forward. And in my legs and feet benumbedness, as if they were asleep by lying double under mee." Thinking it was the scurvy which he previously had, he neglected to use any means. As he grew worse the following autumn he used artificial baths, sixteen in all, and in the spring following "oiles, ointments plaisters" but all accomplished nothing. Finally a weakness affected his whole body so that he could "hardly move his neck a little." He greatly desired Winthrop to come to New Haven to see him.

Two early governors of Connecticut—Edward Hopkins and John Haynes—also need his services. Hopkins appeals to him to see if he can help his wife's condition. She was insane. Some "water" seems to have been sent which was given as directed, but no "altracion in her" was perceived. Haynes has occasion many times to ask Winthrop's assistance on behalf of his wife. In 1649, he writes that his wife is yet in the land of the living but falls into her violent fits when she tries to sit up. Some months later we hear that she "is yett alive, but this month or more was seldom free from her most violent fitts." Shortly thereafter he wishes to send her down to Winthrop at Pequot but could not. He wants to know if the medicine which has been prescribed may be safely given her. Later he speaks of a "little alteration of her fitts appearing, att times" and says he wants to send her down to Winthrop during the winter. If she could not come he would like to know if anything could be administered safely to her at such a distance. A little later he states she has "pain all over her, especially her right side." She has also a "short cough, breaths

shorte, stuffed at the stomache, but rayses not ought." In a footnote he adds "my wife has paine alsoe on her left side, although the most is one the right side, wher the incision was." How much would we give to interpret what the operation was for! The remedies employed must have been somewhat effectual for we read her "violent fitts are but seldomm, her cough is abated, and herself able to sitt upp in a chaire at night for three or fower howres." She fears, however, that the supply of the powder which is to prevent her fits will soon be done and craves a further supply of the same. A month later she continues to improve and new and fresh supplies of medicines are again asked for, as the preventing "phisicke is all spent as is all the rest almost, both drinke and powders." She was also troubled with fainting fits and Haynes wishes to know "whether she might not take of red cowes milk as formerly she did of goates milke." "A soare paine on her backe" as well as other aches and ailments demand Winthrop's attention on other occasions. We imagine he must have grown weary sometimes in hearing and reading the long calendar of her complaints.

In New Haven Colony, Winthrop had as patients the families of a brilliant group of men—Eaton, Davenport and Leete. Theophilus Eaton, the first governor of that colony, was a pure and noble character. He was also a long-suffering man by reason of his second wife, who "seems to have been in the habit of venting a very ugly temper in the most outrageous language to the whole family, from her husband down to Anthony 'the neager.' For she slapped the face of 'old Mrs. Eaton' while the family were at dinner until the governor was compelled to hold her hands; she pinched Mary, the governor's daughter by his first marriage, until she was black and blue and knocked her head against the dresser

First Physicians in America—Their Customs

which made her nose bleed much; she slandered Mary, falsely impeaching her character, and in all points she seems to have been the type of the vulgar step-mother."

In Eaton's first letter he wishes Winthrop to come to New Haven from Pequot and sends a horse to him so that he could "advise, on arrival, for recovery of Davenport's health." Again, thinking to send his daughter Hopkins in the "ffleete," he desires Winthrop's opinion as to the danger of a winter voyage. He later states: "my wife with thankfulness acknowledgeth the good she hath found by following your directions, but doth much desire your presence here, as soone as the season, and your occasions will permit, both in reference to my daughter Hopkins, and my daughter Hannah, who hath bin exercised these 4 or 5 dayes with vapours rising (as we conceive) out of her stomack into her head, hindering both her sleepe and appetite to meate, and apt to put her into fainting ffitts, whether from winde or the mother or from what other cause I cannot informe." Harkening unto this request, Winthrop went down to New Haven and prescribed some remedies. We read that "daughter Hopkins tooke the first potion of purging physick he left and hath kept her bed since and my wife is in some doubt whether she should give her any more of it till she have your advise." In 1655, Eaton informs Winthrop of daughter Eaton's death and wishes him to come, if his family could spare him, to see her husband, who complained chiefly of a cold, a cough and a "paine in the reight side." Samuel Eaton was the son here mentioned. After Governor Haynes' death, he married his widow, of whose ailment we have previously spoken. The last information we have of the family is when we are told "daughter Hopkins hath taken

some of her physick and it wrought kindly."

William Leete, also a governor of that colony and later of Connecticut, for some reason or other, did not desire to employ Rossiter (the village doctor). He consequently, much to Rossiter's disgust no doubt, consulted Winthrop on every necessary occasion. At one time he writes "my wife entreats some more of your phisick, although she feareth it to have very contrary operations in Mr. Rossiter's stomack"—an instance that professional jealousy existed in those days.

Leete's family caused him much concern. In 1658 he writes "our youngest childe, about 9 weekes old, having ever since it was 3 or 4 dayes old, hath appeared full of red spots or pimples, somewhat like to measles, and seemed allwayes to be bigg, and to hang over on the eye browes and lids; but now of late the eye lidds have swelled and look very red, burneing exceedingly, and now at last they are so sweld up that the sight is utterly closed in, that he could not see nor for severall dayes, nor yet doth, and the verges of the lids, where they close, have a white seame, like the white heads of wheales, it is somewhat extraordinary, such as none of our woemen can tell that they have ever seene the like." This child, Peregrine by name, was doubtless the cause of many an anxious moment to his parents. Leete later writes of "his starting, and sometimes almost strangling ffitts, like convulsions, which have more frequently afflicted the infant of late than formerly." We are apt to conceive it probable he says to proceed from more than ordinary painful breeding teeth. His eyes seem to be somewhat better from the use of a "glasse of eye watter" which was also used on other of the children so that "a little further recruit" of the same was desired. Peregrine did not, however, monopolize all the family

A Doctor's Correspondence With His Patients

troubles, for his sister, Graciana, was a weakly, puny thing and gathered strength but very little.

Winthrop's treatment seems to have caused an improvement for shortly thereafter she began "to slide a chaire before her and walke after it, after her feeble manner." She caused trouble, however, in the taking of her medicine and Leete asks for directions "to make her willing and apt to take it; for though it seemes very pleasant of itselfe, yet is she grown marvailous awkward and averse from takeing it in beer. Wherefore I would entreat you to prescribe to us the varyety of wayes in which it may be given soe effectually; wee doubt els it may doe much lesse good, being given by force onely." Andrews' "starting fits" as well as a "distemper which my son William's wife can best explain" demand other letters to Winthrop. Leete also writes about a weak back which afflicted a neighbor's child.

But John Davenport, the first pastor at New Haven, appears to have required Winthrop's services most. In all seventeen letters are to be found containing medical references, most of them are about his wife's prolonged illness, but some concern himself. In 1653 he wishes to go to Pequot to confer with Winthrop over the state of his body. "My wife," he adds, "inclineth to our travayling with you to Boston, if you judge that a place and time fitt for me to enter into any course of physick."

Four years later Brother Herryman's eye caused Davenport much anxiety and he wrote much to Winthrop about it. He says the medicines sent gave some benefit "for it opened the liddes gradually by litle and litle, and gave him ease. But, upon the opening of his eyeliddes, they find that in the eyes, where the sight was, is a matterly substance which brother Peck thinckes flowed out of it (peradventure it is the chrystalline humor); he saith it is ragged, or like white ragges un-

dissolved, which yet he thinks may be easily dissolved; and from the ball of the eye groweth a carnous substance, which covereth the neather eye lid all over, and at the end of it, in the corner of the eye, by his nose, is a tumor of a pretty bignes. Hereby, his eye seems to be as 2 eyes, to them that looke upon it; yet sister Herryman saith she can see his eye under that excrescence. The excrescence is red, and so is his eye. On the 5th day last he tooke the powder, which worked very well, but most upwards, which, sister thinckes, increased the swelling about his eye. Brother Peck thinckes that his eye hath no sense [in] it, nor can they yet say whether the sight is wholly lost, or not, till that white matterly substance be taken away which is before it." Herryman intended, until Winthrop's further directions came, "to put a litle sugar candie into it for the present, which, he saith, may doe some good, and no hurt."

Before this letter was sealed sister Herryman came into Davenport's study with the good news that her husband "could stirre his eye yesterday a litle, and this day more, and that the excrescence from the ball of his eye (which she likeneth to a wheate straw, and toucheth the underlid), lookes a litle paler then it did, that the eye lid growes more plicable, and he can open it a litle himselfe. That tumor by the side of his nose, she saith, is about the bignes of a litle pea. The white that covers the black and darke colour of his eye is as bigg as a penny, and in the midst of that is that ragged matter I wrote of before. Brother Herryman thinckes that he pricked his eye with a bodkin and that might cause this ragged thing about his eye. Sister Herryman and he boath thinck that what you sent workes well; for he findes that he can stirr his eye, which before was as a thing dead and other good effects. He is alsoe at ease."

From the account we have of her

First Physicians in America—Their Customs

Davenport's wife must have been an intensely neurasthenic woman. In 1658 he states that she "hath bene, diverse times, this sumer, and stil is, valetudinarius, faint, thirsty, of litle appetite, and indisposed, sundry times, yet goes about and is between times better and cheerful, yet ordinarily, in the mornings, shee feeles a paine in the bottom of her back." Later he speaks of her being "weake in her spirits and weake stomached." For her various complaints Winthrop dosed her with Rubila (as I will mention later), "pilles" and other unknown medicines without marked beneficial effect. The last note we have of her is in 1667 when Davenport, finding her refractory in taking her remedies, writes in the depth of his despair to Winthrop, saying "my wife tooke but halfe of one of the papers, but could not beare the taste of it, and is discouraged from taking any more. I perceive that some speech from yourselfe would best satisfie her, but if God's providence puttes a bar in the way, we are called to submit thereunto."

Davenport, himself seems to have had a somewhat similar malady for which he was treated by Winthrop. After a course of treatment "by the mercy of God," he declares, "my body is about to returne to its former state, the paine being much abated. I am now content to let nature acte of it-selfe in hope that by God's blessing upon suitable diet, I shall be well againe, in due time."

In addition to all these above named patients mention should also be made of a probable one, "Mrs. John Megs" of Guilford. In 1673, Joseph Eliot, Higginson's successor at Guilford, writes "John Megs" a letter of introduction to Winthrop. In it he asks aid for Meg's wife, who has "a gentle beginning of fits of flatus hypocondriacus yt stir upon grieffe yet without violence for the present."

The best known remedy Winthrop

put up and dispensed was one of his own concoction, Rubila, whose method of making was handed down to his son Wait and grandson John. It is to the latter that Increase Mather wrote on June 23, 1718, desiring a considerable quantity of Rubila sent to Madam Winthrop, his mother, "for the relief of such as the Lord shall please to bless it for yir health." But its composition was unknown from then on till Dr. Oliver Wendell Holmes deciphered a manuscript collection of the medical cases treated by Governor Winthrop from 1657-1669 and came across the following prescription. It was written, as most of them, in symbols which Holmes thus interpreted:

"Four grains of (diaphoretic) antimony with twenty grains of nitre with a little salt of tin making rubila." Perhaps, Holmes states, something was added to redden the powder as he constantly speaks of rubifying or viridating his prescriptions, a very common practice of prescribing when their powders look a little too much like plain sugar.

Unfortunately it would seem from letters subsequently published that something was purposely omitted. Winthrop himself sends some of the powder to his son Wait, and remarks that it not ground enough, and Wait, on other occasions, speaks of some, of his own manufacture, which was not enough ground, half ground, or grossly beaten. He says also "it is best to make it before the weather be hot" and at another time, "the dog dayes will not be so good to medle with rubila in, so it must be deferred at present."

This remedy appears to have been a cure-all. It was given as an antidote in case of fevers, as a preventive against fits, for "sweild legs," for colds, for colics, for agues—in fact for any ailment. In a letter to his brother, Fitz John, Wait states that he knows "no better antidote in feavers then the black powder, niter,

A Doctor's Correspondence With His Patients

snakeweed, *lignum vitæ*, white cordial powder, unicorn's horn, all of which you know the use of."

"Mix snakeweed and *lig. vitæ* with niter to take in the morning; mix fower graines apeice of corall, oculi cancrorum, and ivory, to be taken at any time; thre or 4 grainens of unicorn's horn mixt with the black powder at night; but remember that rubila be taken at the beginning of any illness." Again, discussing Fitz John's distemper, he says that Rubila if taken "at the very beginning of it, must needs abate much of the malignitye of it, and so render it lesse dangerous."

Many in different parts of New England kept a store of Rubila constantly in the house, from which the town was supplied whenever necessity arose. When the powder was exhausted more was written for. In 1653, Deacon Child of Watertown writes "my wife would entreate you send to her a parcell of your physick, divided into portions for young and old. She hath had many occasions to make use thereof, to the help of many." Nearly a year later he says his wife is very ill and "often wisheth she had a ption of yor phisick by wch she and other have found good, and is psuaded should doe again had she off it." Davenport and wife are, also, among those who received bountiful supplies of Rubila on several occasions for themselves, their sick neighbors, and friends. It was once desired by Mrs. Davenport for the good of the people that needed it, yet she says, "she had rather have bene without it, then you should get hurt by sitting up too late." This seems to imply that Winthrop might have spent some time in the making of it or that he chose the night season as he could then prepare it in secrecy, without any interruption. Later Davenport's supply is wholly spent so that though some have desired it they turned away empty. Roger Williams of Rhode Island "sick of a

cold and feaver" asks that this powder might be sent with directions. If the ingredients be costly, he will thankfully account. He then adds "I have books that prescribe powders but yours is probatum in this Country." Again he asks for more as his wife wants some for Mrs. Week's daughter of Warrick.

Though Winthrop died in 1676, yet John Allyn of Hartford, long secretary of Connecticut, had not forgotten the benefits he had derived from taking this powder and writes in 1681 to the governor's son, Wait, for "a small portion of rubila to ly by if your store would permit it." John Winthrop, junior, had previously been the family physician. At one time Winthrop writes to his son Wait, "Tell Mr. Allyn his wife hath a tertian ague wch began the day he went hence, and we hope the worst of it is over. I was with hir this morning, and hir fit was shorter and more moderate then former." Thinking, perhaps, that too little would be sent he then says: "I used to take 8 grains at a time." Richard Wharton of Boston, also, desired some for his cold "which he could not yet shake off and thought that a full supply of it would have saved him a great deal of blood wch he had been forced to part with." And Governor Haynes when John Winthrop was alive writes, too, for working physick or powder which benefitted his wife as "it wrought very kindly alwaies both causing vomiting and purdginge." Subsequently the usual dose was not effectual for we learn twice it hath not wrought at all.

The powder seems to have been rather nauseous in its taste and many objected to take it. It may have been the powder William Leete asks directions about for Graciana his daughter as "she is grown marvailous awkward and averse from taking it in beer." Thomas Mayhew wants some more for his daughter, we learn, as she is now willing (probably aft-

First Physicians in America—Their Customs

much urgings and inducements) to take it. With Winthrop's great-grandson, however, no trifling was permitted. We read in a pathetic letter to his son which Wait has left us: "Poor little Tome taken yesterday with great pain in his stomach, belly, and side, like a plurettick fever; your mother and most of the house up with him all night. He took rubila this morning, and hope he is better." This might mean though that little Tome resisted the taking of this nauseous drug till the morning when, worn out and tamed, he took his medicine, as he ought, like a little man.

When Mr. Stone was sick Davenport endeavored to persuade him to take this powder but did not find him "inclinable, though he was burthened in his stomach." In the same letter Davenport states that Governor Newman took once Rubila, "but finding himself sundrie times ready to faint away, hath not been willing to take it againe, nor his wife that he should, though we persuaded and encouraged him thereunto." Small wonder, then, is it that Wait Winthrop states "for feverishness and restlessness" he has found "nothing help like rubila when there has been *strength* to bare it."

The dose generally was one to two grains, but this amount was at times exceeded for John Allyn, we saw, used to take eight grains at a time and Mrs. Davenport took once "6 graines of rubila." On one occasion it was advised to be given in a "pill don up with bread." For "Ashbyes extremely sweld leggs" Wait Winthrop writes "if he would be persuaded to take rubila in such a proportion as would not work with him tho the fever be not over and to take it every day for som time, it wold insensibly and by degrees take away both the swelling and every evill symptom; he may begin with a grain, or halfe a grain, and so increase halfe a grain every day till it begins to make him a

little quamish, and then the next time decrease halfe a grain or a grain, and then keep to that proportion." This dose would be rather a "cordiall for him than weaken him." It may make him costive and to overcome this, a "spoonful or two of molasses alone, or mixt with a spoonful of oyle, would be as good as anything."

With such a demand for this powder we are not surprised that Wait is obliged, on several occasions, to send for large supplies of some of its ingredients. At one time he asks for "fifty pounds of nitre and twenty pounds of good tartar free from dust."

Besides Rubila, Winthrop prescribed niter ("which he ordered in doses of twenty to thirty grains to adults and three grains to infants") iron, sulphur, calomel, rhubarb, guaiacum, jalap, horse radish, the anodyne mithradate (a shot-gun prescription), coral in powder form, amber and electuary of millipedese. He also used elecampane, elder, wormwood and anise, as well as unicorn's horn. In 1658 Davenport sends him "his owne unicornes horne" which Mrs. Davenport had kept safe for him since he sent it to Mrs. Eaton. Another remedy he probably used was one later in his son's pharmacopœia. It was known as oculi cancrorum and was sent him by Sir Kenelm Digby, who thus describes its preparation.

"Beate to subtile powder one ounce of crabbes eyes (in latin called Oculi Cancrorum), then putt upon it in a high glasse (because of the ebullition) foure ounces of strong wine-vinegar. It will instantly boyle up extremely; let it stand till all be quiett; then straine it through a fine liron, and of this liquor (wch will then tast like dead beere; without any sharpenesse) give two spoonefulls att a time to drinke, three times a day; and you shall see a strange effect in a weeke or two."

A Doctor's Correspondence With His Patients

Although Winthrop treated agues yet I hope he did not employ the following remedy, also sent him by Digby who claims to have had "infallible successe" with it:

"Pare the patients nayles when the fitt is coming on; and put the parings into a litle bagge of fine linon or sarsenet; and tye that about a live eeles neck, in a tubbe of water.

The eele will dye, and the patient will recover. And if a dog or hog eate that eele, they will also dye."

Winthrop's life, which was thus devoted so largely to the public weal in his capacities as statesman and physician, was brought to a close on April 5, 1676, but the good which he wrought is not forgotten and will be ever cherished, even by future generations.

WAIT WINTHROP TO (DR.) JOHN WINTHROP IN 1673.

HONORED SR,—I received yours by Mr Roswell, and haue heard noeting from Connecticut since, till Mr Steele and Mr Barnad came last weeke and brought newes of yr health, which, a day or two before they came, was otherwise reported heere, that you weare sick againe; but when I had inquired into it, I found noe ground for it (God be thanked). Mr. Usher did fully understand my proposition about the reserve for three years, which you doubt of in your letter. Here is little newes. Thay are all well at Salem and Wenham: I was there about a weeke since. There was a sad accident fell out at Wenham about a fortnight since. Mr Higenson went from Salem to preach there on the Sabbath day; and after the evening exercise, he being with severall of this towne at my sisters house, in the parler, there being a thünder shower, the lightening brake (as I suppose, haveing veiwed the place, the house being somthing damnified) on the top of the chimney, and balls of fire came downe into both the lower roomes, and the chamber over the parler, which killed one Goodman Goldsmith, as he sat by the chimney in the parler, talking with Mr Higgen-son and others, and through Gods mercy hurt noebody els; only, the mans dog. which laye under the chayre which he sat in, was killed alsoe. My sister, with all the children, weare in the outward kitchen, as providence ordered it. Here came one Jones, of Charlestowne, in from Irland, the last night, but brings not newes that I yet here of, but that severall of the New England ships bound for Fngland are taken and noe newes that any are arived. I enquired of Mr Nicoles about his being cured, who tells a strang story about the maner of it; but all that was done was that his mother tooke the juice of the elder leaves and dressed his wounds, or sores, which he had in many parts of his body, and gave him the distilled water to drink, about a gill at a time every morning, or halfe a gill, I am not certaine which, and he was well in a fortnight or 3 weekes, who before dispaired, not only of being cured, but of life, alsoe. I am apt to believe that a little quantytype of the juice being drunk would be more effectuall then the distilled water. I have not els to ad but my duty to yourselfe and love to my sisters and remaine

Your obedient son

Boston, June 9th, 1673.

WAIT WINTHROP.

LETTERS OF ONE OF AMERICA'S FIRST PHYSICIANS

(DR.) JOHN WINTHROP TO HIS FATHER IN 1628.

To the wor his very loving father, John Winthrop, Esq., in Groton.

SIR,—My duty remembered unto you, I am very sorry to heare that your hande continueth so ill, but I hope, by Gods providence, you shall finde helpe by those things I have sent you, which I receyved from a woman that is very skilfull, & much sought unto for these thinges. She is sister to Mr. Waterhouse the linnen draper in Cheap side, by whose meanes, I was brought to her. She told me, if you were at London she made noe doubt but to cure it quicly, but because you cannot come up she therefore gave me these plaisters to send to you, & said that if it were not gangreened she would warrant them by Gods helpe to doe you present good. The use of them is as followeth. Take the yellow plaister, as much as will cover your sore finger all over to the next joynt below the sore, and on the rest of your finger wheron this plaister doth not lye, lay as muche of the blacke plaister as will cover it all over, this must be done twice a day, morning & evening, till it beginneth to grow well, then once a day. The other blacke plaister you must lay all over your hand, & must not wash it, nor lay any other thing to it. This will draw out the thorne, if any be in, & heale it both. She will take nothing for it, & therefore I doe the rather credit hir, for she doth it only for freinds, &c. I pray you therefore use it, & leave of any other course of surgery. I wish you were here at London where she might dresse it her selfe. For newes I cannot write so good as the last; this bearer will fully satisfye you of all proceedings, which every day alter & change, some like to be good, by & by crosse againe.

For my voyage to new England I doe not resolve (especially following my uncle Downings advice) except I misse of the Straights, but I will stay till you have sold the land though I misse of both: thus with my duty remembered againe to your selfe, with my grandmother & mother, & my love to my brothers & sisters & the rest of our freinds, I commend you to Gods protection & rest

Your obedeint Son

London: April 11, 1628.

JOHN WINTHROP.

JOHN WINTHROP, ESQ., TO HIS SON IN 1637.

To his very loving Son, Mr. John Winthrop, at Ipswich, d'd.

My Good Son,—I received your letter, and heartily rejoyce and bless the Lord for his merciful providence towards us all, in delivering your wife from so great a danger. The Lord make us truly thankful. And I hope it will teach my daughter and other women to take heed of putting pins in the mouth, which was never seasonable to be fed with such morsels. I can write you no news, only we had letters from Conectacott, when they were shut up with snow above a month since, and we at Boston were almost ready to break up for want of wood, but that it pleased the Lord to open the bay, (which was so frozen that men went over it in all places,) and mitigate the rigor of the season; blessed be his name. On Friday was fortnight, a pinnacle was cast away upon Long Island by Natascott, and Mr. Babbe and others, who were in her, came home upon the ice. We have had one man frozen to death, and some have lost their fingers and toes. Seven men were carried out to sea in a little, rotten skiff, and kept there twenty-four hours, without food or fire, and at last gat to Pullen Point.

We have appointed the general court the 12 of the 1 month. We shall expect you here before the court of assistants. So, with all hearty salutations from myself and your mother to yourself and wife, and little Betty, and all our good friends with you, I commend you to the blessing of the Lord and rest

Your loving father,

Jo: W.

I send you herein the warrant for Ipswich and Newbury. Commend me to your brother and sister Dudley.

"Xith, 22, 1637.

LETTERS OF ONE OF AMERICA'S FIRST PHYSICIANS

LUCY DOWNING TO (DR.) JOHN WINTHROP IN 1640.

To her most honored nephew, John Winthrop, Esq., this present, Boston.

SIR,—Wee now expect you stay for 6 boyes, you are gone so longe. Indeed wee want your company very sensible. My lady Susan, I hear, is now deliuered, therefore, in poynt of good manners, your wife may now presume to be eased of her load also. If occasion be for your longer stay, I pray, Sir, let Georg know I expect him with this bear, Msr. Ruke, or the next conuenience; also my husband desiens to know if you will part with some hay that you have; we are in much want ells. I pray your spediest answer.

I have experimented the crocus this 2 nights, and found much, though not a totall freedom of payne therebey. I pray let me know if I may safely aply it to the mould of my head.

I thank you much for your advise and I pray to my brother also give my many thanks, and to all my servis and best wishes, is

Yours,

Jan. 29, or Tuesday. (1640-1.)

L. D.

All our newes is out of Eng. I hope you haue it before vs. Wee have put his Grace of Canterbury fast in the Tower; and if our St. Peter keeps the keyes, his grace is like to colle his shins, ere he gets in, this could weather; for we speak only of his confusion and unpardonable sins.

HUGH PETER TO (DR.) JOHN WINTHROP.

Good Son,—My truest love unto you and all yours in Jesus Christ our dearest Lord. These may certifie you that I doe long for your company as much as the teeming earth for the rising sun. Let not your wife bee ouerdeiected, for my part I am as deep in my obstructions as at Rotterdam. I pray speake to your wife that Mat: Lake and my mayd hope may bee with her, and then I believe shее shall have two tolerable servants. My head is not well, nor any part at present for I cannot get sleepe. I would you should send me word what you will doe therin, but rather come over. Oh how my heart is with you. You doe not know how much I need friends and helpe.

Tell my dear friend your sister Symonds that I am as low as ever, & wish I knew how to see her. Thus in much hast & perplexity I take leave & am yours ever,
Salem ult. Sept.

HU. PETER.

HUGH PETER TO (DR.) JOHN WINTHROP IN 1649.

ffor John Winthrop, Jun., Esq., with a (t)oken in paper.

DEERE SIR,—I feare you are angry because you doe not heare from mee, nor I from you. I have by Mr. Gott ordered you what I have in New England (a line effaced) word I ever loved you and yours, and am truly sensible of all your cares. Nothing under heaven hath more troubled mee then that you had not my company into New England with you. I have sent you by this bearer a load stone which I pray keepe for mee if I come, if not it is yours. Oh that I were (a line effaced) my old malady & the spleene, & never had hart or tyme to attend any cure, that now I give my life gone: & shall out live my parts I feare. My hart is with my God & desire after him in whom I am

Yours ever

30 of April 49.

HU: PETER.

LETTERS OF ONE OF AMERICA'S FIRST PHYSICIANS

GOVERNOR JOHN HAYNES TO (DR.) JOHN WINTHROP IN 1653.

To his much honoured frind, Jno. Winthrop, Esq. att his house in Pequott, these bee d'd.

SIR,—I received the powder you last sent, together with your kind token, a fatt goate, for which I retorne hartly thanks. Thus it pleases you still to lade mee with your kindness, myselfe too short and awanting for requitall. If this Irish woman is come upp to you (yourselfe befor being supplied) I pray you let her by the first opportunity bee conveyed to us, for I did soe order it, hoping to have pleased, not to burthen you. Mr. Eaton writt lately to Captaine Cullicke that the English have had another fight at sea with the Hollander (besides what we had formerly) & have obtained another glorious victory over them. Thus it pleases God to goe out with our Nation to vindicate our iust quarrel. Your youngest sonne, (Mr. Waite) hath bine somewhat ill of late complaininge of a paine in his belly, & withall lookes somewhat heavy eyed, not soe ready to stir upp and downe as formerly, yett keepees not his bedd, but rises dayly, & seemes for the most parte to have a pretty good stomache to his meate; only wee judge it best, for the while, that hee keepe his chamber. We gave him wormseed (as supposing it might bee wormes, by reason this time of yeare for fruite, & youth will hardly be restrained wher ther is plenty), I thinke, upp on it Mr. Ffitch said hee voided some wormes, but in regard the paine in his belly followed him still at times, we gave him Cardis, (?) & that, wee hope, did him somme good. This daye wee thinke to give him two graines and a haulfe of your powder, in case he still remains ill. Wee conceive yourselfe would doe the like if you were present, & somme of us have bine ill much in like manner, & these thinges were present helpe to them (the Lord blessinge the meanes) which caused us thus to act. Mr. Ffitch would doe nothing without my advice & concurrence with him, and my skill is little or nothings, only I did as for my owne, & would in truth (in your absence) take the like naturall care, if in my power to doe ought that ways. I hope there is not the least danndger, yett I could not but acquaint you with it, because it may please God to direct you to advise for the best, & to send something usefull for him in that case.

My wife continues much as formerly; she took the yellow powder twise, & only vomited it up againe, & it wrought noe other or more; alsoe, since J. Gallop was heere, she tooke the working powder, 2 graines, but it wrought not at all, insomuch that she at times is sicke at her stomache; yet her appetite better than formerly.

I have not further to imparte att present, only our respects to yourselfe & Mrs. Winthrop, with our consideration to Mrs. Lake, (and) Mr. Blinmah, rest

Your assured loving frind,

Hartfd. this 14th of the 6th mo: 1653

JO: HAYNES:

Your sonne became ill upp on Thursday last weeke, & soe hath continewed at times ever since.

SAMUEL SYMONDS TO (DR.) JOHN WINTHROP, IN 1647.

To his very loving brother, John Winthrop, of Salem, Esq., this Salem.

GOOD BROTHER,—Having this opportunity, I thought good to let you understand God's providence towards us: my daughter Epps, upp on the 22th of this instant, was delivered of a sonne; & thanks be to God, both mother and sonne are comfortably well. We would gladly know what day you will agree upp on to bring my sister, that accordingly we may send you a horse to the water side. I thank God my wife hath bene better in respect of the paine in the stomach this weeke than formerly; good wine (as you say) is the best cordial for her.

I have endeavoured this day to sett that businesse Cosen Downing wrote me about, on foote, here. I wish earnestly it may be attended, &c My wife desireth thanks to be returned to my sister for her token. Thus with our love to you both & yours, & to my Cosen Downing & his, I rest

Your ever loving brother

Ipswich, 24th 12th 1647.

SAMUEL SYMONDS.



John Winthrop

ONE OF THE FIRST PHYSICIANS IN AMERICA

Born in 1606—Educated at Trinity College, Dublin—Studied Law at the Inner Temple—Entered the English Naval Service and sailed in an Expedition with the Duke of Buckingham—Immigrated to the New World, became a leading Chemist and was elected Governor of his Colony—Portrait from Oil Painting at State Capitol at Hartford

LETTERS OF ONE OF AMERICA'S FIRST PHYSICIANS

SAMUEL SYMONDS TO (DR.) JOHN WINTHROP IN 1658.

To the right Worshipfull John Winthrop, Esqr., Deputy Governour, this present.
Connecticott.

DEARE BROTHER,—I gladly imbraced this oportunity to salute you with these few lines. My cosens (all three) were in health, & as merry as very good cheere & Ipswich friends could make them, on sixt day last; witness my wife, sister Lake; Sam: M: R: Mris Rogers, 3 of her sonnes, besides her sonne Hubbard & his, my sonue Epps & his, &c. We see nothing but matter of hopefulness & incouragment concerning my cosens new con-dicion. He carrieth himself soe that he gaineth more love & respect, amongst such as know him.

We hope they will live comfortably together, & that both you & we shall have cause to bless God in their behalf. We desire my cosens to be with vs this winter as much as they can. My wife spoke to her. We think she may affourd vs her company now better than afterward. My daughter M: desires to be excused in not returning an answer to your loving letter at this tyme. She hath received your phizich for which she humbly thanks you. Neither she nor her sister R: have had them since you were here. They did follow your direccions. Thus presenting our love & kinde respects to yourself, my sister, & all my cosens, I commend you, to the direccion & proteccion of our blessed Saviour & we rest,
Your loving brother,

SAMUEL SYMONDS.

My wife desires to be remembered to my cosen Waite & would entreat him to study hard: but above all to feare God & keep his commands.
Argilla, gbr 29th 1658.

STEPHEN WINTHROP TO (DR.) JOHN WINTHROP IN 1653.

To my honored brother, Jo: Winthrop, Esqr., these present, att Pequod' or elsewhere in
New England.

DEARE & HONORED BROTHER,—I received yrs, & thanck you most kindly for it. It was much refreshing to me, though it repeated a great matter of sadness to me, even the losse of my deare brother, wth whom I was brought upp so constantly; but I know the Lord sitts in heaven, & doth whatever he will, & we must submit to his pleasure. I should have writte unto you before, but yt I knew not when the shippes went. Jo: Tinker promised to call on me but failed me. I have sent a letter of attorney over to you. I am bould to put in your name yt the others may the better take yor advice, though I should not put the trouble of the busness upp you. Truly I doe valew what I have there; for, could I be assured of my health, I think I should come away imediately, for I have no health heare, & I have been this two years extreamly troubled wth the zeatica, & I am just now goeing to the bath to see if yt may remedy it. My much lying in ye wet feilds uppon the grownd hath brought it uppon me, as it has uppon many others. It makes my life very uncom-fortable. For newes wht should I write to you? Every passinger will be able to tell you the latest. At present the warres betweene the Dutch & we contynue, though we have twice this somere beaten there maime fleet, consisting off 120 of there best men of warre; and at last blocked them upp in there harbors for severall weekes, though we heare b. reports they are gott out againe, & we expect a new engagement.

The Dutch embassidors are yet heere; but there is no iikelihood of any agreemt. We demand three causionary townes of them, ye Brill, Flushing, & Middleborowe, & 400,000l satisfaccon. They are not yet love enough to give it, and so ye case stands. Or own state is not settled; or doubt & feares many. All the comfort is, ye Lord is able to doe his owne worke and finish it. Mine and my wife humble respects to you & or good sister, & love to all or nephewes and necces I pray present; & be confident

I am, sir,

Yor most affectionat brother & servant,

Kensington, 2 Augt. '53.

S. WINTHROP.

Just now a messinger is come from ye fleet, & brings letters yt say ye two fleets have been engaged three dayes, & now the Dut(c)h are flying & or persueing, & yt already we have taken & sunck fortye of there best men of warre. This is thought will putt an end to there warre & make them submit.

LETTERS OF ONE OF AMERICA'S FIRST PHYSICIANS

LUCY DOWNING TO (DR.) JOHN WINTHROP IN 1674.

For her much honerd nephew, Jhon Winthrop, esq., thes. New Eng.

DEAR CHILD,—In my other leter I have bin so larg as prevents a seale, yet not satisfied my self: as to my bodily distempers, which is a great weakness in my back, which was first occasioned by a great fall of my hors in new Eng. behinde Collonel Read, and the 2 last years I was in Hatly, I had in each of them, 2 daungerous falls, one up staires and one down staires, which did much bruise that tender parte againe, and had not a devine hand bin under had bin present death, and still allthought I have not usuallie I have not much payn there, yet am much disabled in my legds for goeing, especially in could weather or any could taken, yet I constantly wear some plaster upon it. And my hearing hath much declined this 3 years last, for the help of which I did advise with a Cambrigh docter, a very able experunced doter before I came to London, and he tould me I must expect my age to be a great meanes thereof; and that he feared that the more I did tamper with my eares the wors it might be for me; and soe a dockter I did advise with hear tould me the like; and my ould acquaintance in London being all gone I am not willing to a further hazerd of my eares and my mony also for nothing. And in Sep. last I was taken with a great giddiness in my head, and a great noise in my ears, and sickness in my stomach, and a generall distemper all over me, soe as I was forced presently into my bed; it would take me a moment without any warning, and then I should presently sleep and then for a day or 2 after tacked onelie mace alle whould down with me. But I thank God I have not had any of that distemper this year, now of the noise in my ears, which I suppose may be because I now keepe my ears warmer; and since I have had that freedom I thanck God my stomach is much better. And in respect your sister Peters is now forced for her present profit to confine herself to a small part of her hous, and I am necessitated by my weakness to keepe a servant to help me, I found it more to my profit; since I must give 7 pound a year for my chamber and furnish it myself, and find myself cooles and candilles and wasing, and to pay for our boards with her besides, for now allthought I may feare the harder, yet I can take my owne time, for want of which I formerly sufferd, and now I an less troublesome to her. But I am now att ten pound a year for my chamber and 3 pound for my servants wages, and have to extend the other tene pound a year to acomadat for our meat and drinck; and for my clothing and all other necessaries I am much to sake, and more your brother Georg will not hear of for me; and that it is onely couetousness that maks me aske more. He last sumer bought another town near Hatly, called Clappum, cost him 13 or 14 thousand pound, and I really believe one of us 2 are couetons. Cooles have ben this winter at fiftie shill and 3 pound a chaldron, and wheat at ten shills a bush, and all other things sutible thereunto. The good Lord helpe me to live by fayth, and not by sence, whilst he pleas to afforde me a life in this world. And ths is the onlie cause of my soe much urgentie in the former leter for supply from what I have there, if it may soe be. If my nephew Winthrop comes into the Bay this summer I pray show him this leter, with my servis to him and his: and I am very sorry for his loss: and tell him I find a deed of Groton for my life, wherin himself and his brother Adam Winthrop are feffees in trust for me, and after me to my son Georg, but whilst I live it inables me to charge what portions apon it I pleas, to be payd therout after my death unto any of our younger children. In witness therof is my husbands hand and seale the 23 of June 1644, and sealed, delivered, and acknowledgd befor me, John Winthrop, D. G., and I suppose my brother was that year deputie Governer. And my nephew Adam tould me it was enroulled at Boston. And if soe, heare I know it can doe me, nor mine, noe good. I took advise of a frind that tells me the coutrary, but I would know of my nephew if by that priviledgd for my children, I being in want, I can make any advantage of it for myself whilst I live, and after me for my daughter Peters, whoe never yet had any portion, and to her I am suer it will not be offensive to my son Georg, whilst the principall remains to him, it being his patrimonie. I pray, daughter, let none see this, but my nephew Winthrop and your self, and to that purpose I will seale it and superscrib it to him to prevent mistake.

Your very loveing mother,

Apr. the 17 74 Gardner laine.

L. D.

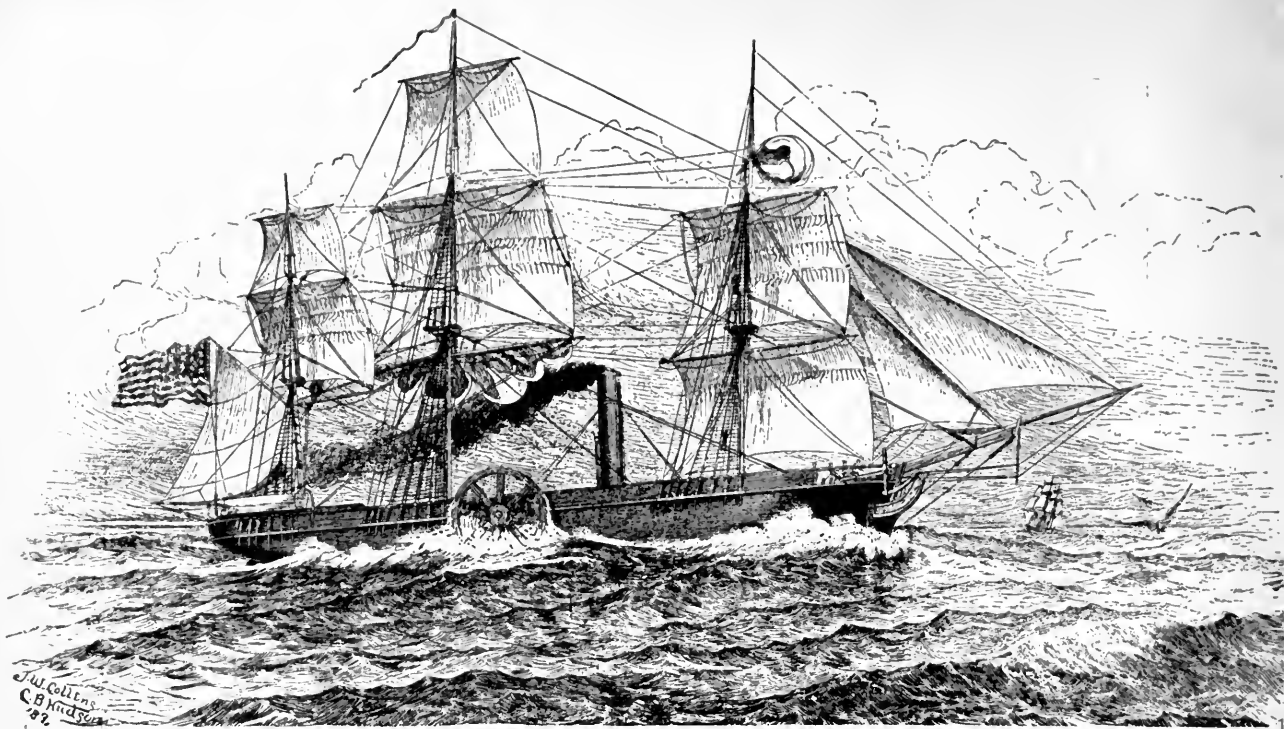

FIRST STEAMSHIP TO CROSS ATLANTIC OCEAN

The "Savannah," under courageous Captain Moses Rogers, a pioneer steam navigator, sailed from Savannah, Georgia, on May 22, 1819, and arrived in Liverpool, England, on June 20th, making the run in 29 days and 11 hours—From corrected drawing by C. B. Hudson, made under the direction of Captain J. W. Collins, of the United States Commission of Fish and Fisheries in 1889 and officially incorporated in the Report of the National Museum in 1890

First Steamships to Cross the Ocean

Recollections
of Men who Participated
in the First Futile Attempts to
Interest Capital in the Possibilities of
Communication between the Continents by Steam & Opening
the Gateways of the World & Historic Voyages & Beginning of Commerce

BY

C. SEYMOUR BULLOCK

AUTHOR OF "THE MIRACLE OF THE FIRST STEAMBOAT"

SINCE the beginning of time, men have labored over the mysteries of navigation by land and sea and air. The great problem of availing ourselves of the power that is manifest in man and in nature goes back to creation itself and will be the strongest element of life until the end of the ages. The little giant that now, in hauling the freights upon our railroads does the work of more than 250,000,000 horses, had in the far-off days been made to open and close the doors of Greek temples, to pump water, to turn wheels, to help in mines, to propel automobiles, and to provide a way for moving heavy artillery into the line of battle. When men brought the dawn of a better day in which this marvelous power should willingly serve the many instead of the few, the populace scorned its promoters and its possibilities.

While to-day we are riding the ocean in luxurious palaces it is well to remember that patient men gave their lives to persuade us to accept the gift that has brought the world into one common family. Those who are enjoying its privileges to the fullest possibility are the very ones who too frequently repudiate the original idea.

When Junius Smith conceived trans-oceanic navigation by steam as a business proposition the good captains of trade remarked that "the establishment of steam communication with the moon is quite as feasible,"

and one business authority repeated: "Earth has its bubbles as the water hath, and this is one of them."



FIRST PROMOTER OF TRANS-OCEANIC
STEAM NAVIGATION

Junius Smith, whose scheme of organizing capital to ply steamships between the continents was considered chimerical and disdained by both American and European capitalists—Portrait from an Oil Painting in possession of his niece, Mrs. William Lay, Chicago, Illinois—Reproduced by permission

First Steamship to Cross the Ocean

"We use nor Helm nor Helmsman. Our tall ships
Have Souls, and plow with Reason up the deeps;
All cities, Countries know, and where they list,
Through billows glide, veiled in obscuring Mist;
Nor fear they Rocks, nor Dangers on the way."

IN these words from the "Odyssey," as found in Ogilby's edition, one finds the story foretold of the steam engine as employed upon the sea. How strange and hardly possible it seems that the whole story of steam in ocean navigation, when it had become reality, not prophecy, may be culled from the memory of one man's life. I was talking not long ago with a man who remembered the sailing of the "Savannah" under courageous Captain Moses Rogers, who in 1819 went from Savannah, Georgia, to Liverpool, England, and thence to St. Petersburg, Russia, and back to Savannah—the first steam voyage across the Atlantic Ocean. A few days ago I looked upon the "log" of that famous trip, with the silver tea-kettle that was presented by Lord Lydenhurst to the intrepid captain, which may now be seen in the National Museum at Washington.

The "Savannah" was of about three hundred tons burden, clipper built and full ship-rigged. She was propelled by one inclined engine, not unlike those now in use, with a cylinder forty inches in diameter and a piston stroke of six feet. The boiler carried a steam pressure of only twenty pounds. Her paddles were of wrought iron with only one flange and were entirely uncovered, though it is probable that a canvas wheel-house was made to cover them soon after the voyage begun. These wheels were so attached to the shaft that their removal and shipment on deck could be accomplished in fifteen or twenty minutes. There were two

fine cabins for passengers, both handsomely furnished, and the thirty-two berths were in state-rooms that were provided with all the comforts and conveniences then demanded. But the "Savannah" was not properly a steam-ship. She was an "auxiliary clipper" and used her engine only a part of the time. On the voyage to Liverpool the engine was used for eighty hours, and on the thirty-three days' run to Petersburg the engine was used for about two hundred and thirty-nine hours or nearly ten days.

After returning home the "Savannah" was once more turned into a sailing vessel and put upon the old run between New York and the city for which she had been named. On the fifth of November, 1821, while under the command of Captain Holdridge, she was driven onto Great South Beach, opposite Moriches, on the south shore of Long Island, and became a total loss. Her machinery, which had been removed, was bought by James Allaire who exhibited the cylinder at the fair in the Crystal Palace, New York, in 1856.

The "Savannah" was not built for a steamship and entries in the "log" record the many times when the wheels were "shipped" and the boat depended upon its sails. This has led our British cousins to claim for themselves the honors of having first introduced steam navigation on the high seas. They quote the record of the "Royal William," built at Cape Blanc near Quebec, in 1831 to run to Halifax, in sailing from Quebec in 1833, "under steam for the port of London," as a refutation of all our claims.

During my college days at Evanston, Illinois, I met and frequently talked with James Goudie, builder of the "Royal William." He told me of those earliest attempts to master the terrors of the deep. I here state emphatically that nothing more came out of the voyage of the British "Royal William" than had come from the achievement of the American "Savannah" fourteen years earlier.

Log of First Voyage Across the Ocean

Steam ship Savannah Moses Rogers Master

A Journal of a voyage from New York towards Savannah on board

Monday March 1819	These 24 hours begins with fresh breezes at N.W. at 10 AM got under way for sea with the crew on board at 1 P.M. the pilot left the ship off Sandy hook light			Remark on board Monday March 29 th 1819
H	K	W	W	
1	4			<i>These 24 hours begins with fresh breezes and clear at 2 P.M. the Hilands of Neversink bore S.E. 7th 6 Leagues distant from which I take my departure at 4 P.M. took in Topgallant Sails at 6 P.M. set Topgallant sails at 8 P.M. Tacked ship to the Westward. Saw shrim and schooner steering to the Westward at 11 A.M. took in the Mizzen and Fore Top Gallant Sails at 12 A.M. got the Steam up and it came on to blow fresh we took the Wheels in on deck in 30 minute at meridian fresh breezes and Cloudy</i>
2	4			
3	4			
4	7		South W.S.W.	
5	3			
6	3		S.S.E. 7 th W	
7	3		S.E. South	
8	3			
9	3		S.E. West	
10	3			
11	3		S.E. S.W.	
12	3		S.S.E. South	
13	3			
14	3			
15	3			
16	3			
17	3			
18	3			
19	3			
20	3			
21	3			
22	3			
23	3			
24	3			
25	3			
26	3			
27	3			
28	3			
29	3			
30	3			
31	3			
32	3			
33	3			
34	3			
35	3			
36	3			
37	3			
38	3			
39	3			
40	3			
41	3			
42	3			
43	3			
44	3			
45	3			
46	3			
47	3			
48	3			
49	3			
50	3			
51	3			
52	3			
53	3			
54	3			
55	3			
56	3			
57	3			
58	3			
59	3			
60	3			
61	3			
62	3			
63	3			
64	3			
65	3			
66	3			
67	3			
68	3			
69	3			
70	3			
71	3			
72	3			
73	3			
74	3			
75	3			
76	3			
77	3			
78	3			
79	3			
80	3			
81	3			
82	3			
83	3			
84	3			
85	3			
86	3			
87	3			
88	3			
89	3			
90	3			
91	3			
92	3			
93	3			
94	3			
95	3			
96	3			
97	3			
98	3			
99	3			
100	3			

Lat by Obs 39-13'

PAGE FROM LOG OF FIRST STEAMBOAT TO CROSS ATLANTIC OCEAN

The first entry is as follows:

A Journal of a voyage from New York towards Savannah on board steamship Savannah: Moses Rogers, Master.

On the fifth page this is changed to read:

A Harbor Journal on board steam-ship Savannah, Moses Rogers, Master.

Later on we read:

A Journal of a voyage from Savannah towards Liverpool on board steam-ship Savannah, Moses Rogers, Master.

The first entry describing the voyage may be found, with the caption of the first page, in the fac-simile herewith. The second entry is as follows:

Remarks on board Monday March 29th, 1819. These 24 hours begins with fresh breezes and clear. At 4 P. M. the Hilands of Neversink bore N. b. W. 6 Leagues distant from which I take my departure. At 10 P. M. took in Topgallant sails. At 6 A. M. set Topgallant sails. At 8 A. M. Tacked ship to Westward. At 11 A. M. took in the Mizzen and Fore Top Gallant Sails. At 11 A. M. got the Steam up and it came on to blow fresh air we took the wheels in on the deck in 30 minutes. At Meridian fresh breezes and Cloudy. Lat. by Obs. 39 19.

During the next two days the vessel encountered heavy gales and strong breeze but on Saturday there is the entry:

These 24 hours begins balm and pleasant. Used wheels middle of the day.

On the eleventh of May we find this entry:

These 24 hours begins with light breezes at N. W. and pleasant. . . . President of the United States James Monroe and suit came on board the ship at 7 A. M. to go to Tybe light. . . . At 8 A. M. got the Steam up.

After a pleasant excursion, the first at sea on an ocean-going steamship, the party returned to the city in the evening. The next day the first casualty at sea is entered in the words:

Daniel Claypit cut his left thumb off, the Doctor done it up and then bled James Monroe.

It was expected that the steamship would sail for Liverpool on the 19th and as we have shown elsewhere, it was so advertised. Doubtless the cause for delay is to be found in the following entry:

Log of First Voyage Across the Ocean



CAPTAIN OF FIRST OCEAN STEAMSHIP
Moses Rogers, master of first steamboat to cross
Atlantic — From crayon portrait when Captain
Rogers was about 21 years of age — Artist unknown

May 19th John Western coming on board from the shore fell off the Plank and was Drowned, he was a native of Massachusetts, Town of Gray. At 01 A. M. caught John Western with a boat-hook and jury was held over an brought in accidental Deth took himm on Ship and put him in a Coffin.

On the twenty-second, Captain Rogers "got steam up and at 9 A. M. started" on the trans-Atlantic voyage. There is not much of interest in the entries until we come to the record of June second, when we learn that he:

Stopped the Wheels to clean the clinkers out of the furnice, a heavy sea, at 6 P. M. started Wheels again; at 2 A. M. took in the Wheels.

Land was sighted June sixteenth, and the next day the "Savannah" being then off the coast of Ireland, was boarded by the King's Cutter, "Kite," Lieutenant John Bowie.

Unfortunately, the log-book here as elsewhere, because of its brevity, is far from satisfactory. However, in this case we have far fuller account of the amusing incident in connection with this boarding of the "Savannah" by the King's cutter. In a letter to the New London, Connecticut, *Gazette*, Stephen Rogers, the engineer, says that the "Savannah" was taken to be a ship on fire and that:

The admiral dispatched one of the King's cutters to her relief. But great was their wonder at their inability, with all sails set in a fast vessel, to come up with a ship under bare poles. . . . After several shots were fired from the cutter, the engine was stopped, and the surprise of her crew at the mistake they had made, as well as their curiosity to see the singular Yankee craft, can be easily imagined. They asked permission to go aboard, and were much gratified by the inspection of this naval novelty.

Two days later, June 20, they:

Shipped the wheels and furled the sails and run into the River Murcer, and at 6 P. M. come to anchor off Liverpool with the small bower anchor.

A stay of twenty-five days was made at Liverpool during which time the vessel was not only a center of curiosity but an object of much suspicion. The newspapers of the day suggested that "this steam operation may in some manner be connected with the ambitious views of the United States." One journal, recalling the fact that Jerome Bonaparte had offered a large reward to any one who succeeded in rescuing his brother Napoleon from St. Helena, offered the surmise that the "Savannah" perhaps had this undertaking in view.

Moses Rogers in his log says:

Naval officers, noblemen, and merchants from London came down to visit her, and were curious to ascertain her speed destination and other particulars.

Later on we find the record of a case of mutiny among the crew. The entry for June nineteenth is as follows:

These 24 hours begins with fresh breezes and rain. Captain Rogers told Mr. Blackman to go on shore after James Bruce and John Smith to get them on board. They would not come; the watchman put them in a boat. John Smith tried to nock Mr. Blackman overboard Struck him several times, he Swore he would take Mr. Blackman's life but Mr. Blackman got him on board and he denied his duty and then he was put in Irons. Middle and latter part fresh gales at S. W. and rains.

The next day's entry shows:

John Smith still in Irons.

Log of First Voyage Across the Ocean

The following day we find:

At 5 A. M. took the Irons off John Smith he went to duty.

On the twenty-third July the "Savannah" sailed for St. Petersburg, "getting under way with steam" and "a large fleet of Vessels in company." Copenhagen and Stockholm were "touched" on the way and at the latter place she was visited by the royal family. This visit is recorded as follows:

His royal Highness Oscar Prince of Sweden and Norway come on board.

While here the "Savannah" was also visited by "Mr. Huse (Christopher Hughes) the American Minister and Lady and all the Furran Ministers and their Laydes" and when she sailed she had on board as a passenger Sir Thomas Graham, Lord Lynedock, of England. She left Stockholm on the fifth of September and on the ninth she reached Cronstadt, having used steam for the entire trip.

Upon the invitation of our ambassador at the court of St. Petersburg, when the vessel arrived there, a few days later, there was a visit by the Russian Lord High Admiral, Marcus de Travys, and other distinguished naval and military officers who tested her superior qualities by a trip back to Cronstadt and return to St. Petersburg.

The "Savannah" lingered at St. Petersburg until the tenth of October, when she again sailed out under steam and this time with her bow toward home. Captain Rogers carried away with him as a substantial reminder of the success of his voyage a massive silver, gold-lined tea-kettle, upon which the donor had engraved the following inscription:

Presented to Captain Moses Rogers of the
Steam-ship Savannah
(being the first Steam Vessel that had
crossed the Atlantic).

by Sir Thomas Graham, Lord Lynedock,
a passenger from Stockholm to St. Petersburg.

September 15, 1819.

Stephen Rogers was also the recipient of many valuable gifts and among them was a beautiful gold snuff-box from the Emperor of Russia.

The "Savannah" arrived at her home port on the thirtieth of November. The log is continued for about two weeks afterward and then abruptly comes to an end. The last entry but one is so characteristic of the man who dared to do what no one else had ever before attempted, even after it had been foretold by the man who first brought together for propulsion a steam engine and a wheel, that we use it on the closing words of a sketch necessarily brief:

Frank Smith damd and swore at the Captain and struck at the Captain and struck him two or three times and then Smith was put in Irons.



CAPTAIN MOSES ROGERS AT AGE 40 YEARS

As courageous Captain Rogers steamed into the port, the people along the shore believed his craft to be some weird monster and were awe-stricken

Development of Steam Navigation

Rare Prints of Early Steamboats in American Waters



STEAM PACKET "CHANCELLOR LIVINGSTON"—1817

Built from plans drawn by Fulton for a corporation that held a monopoly of the waters of New York state for the use of steam propelled vessels—Photographed from a rare old print

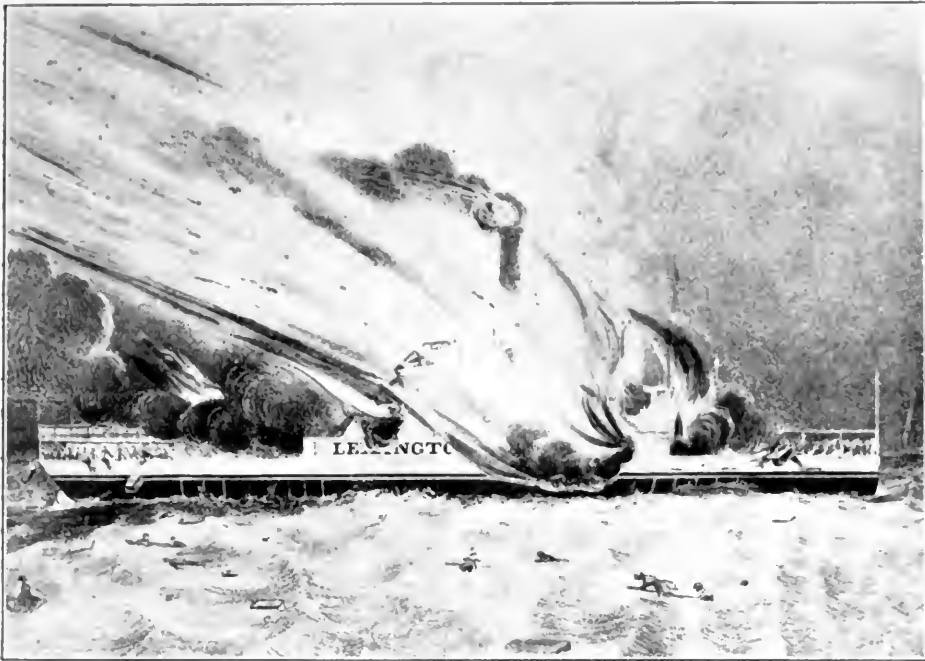

"LEXINGTON"—DESTROYED BY FIRE ON RUN FROM NEW YORK IN 1840
 There were about one hundred and fifty passengers and only four were saved—Illustration is from rare lithograph circulated during the excitement created by news of the disaster

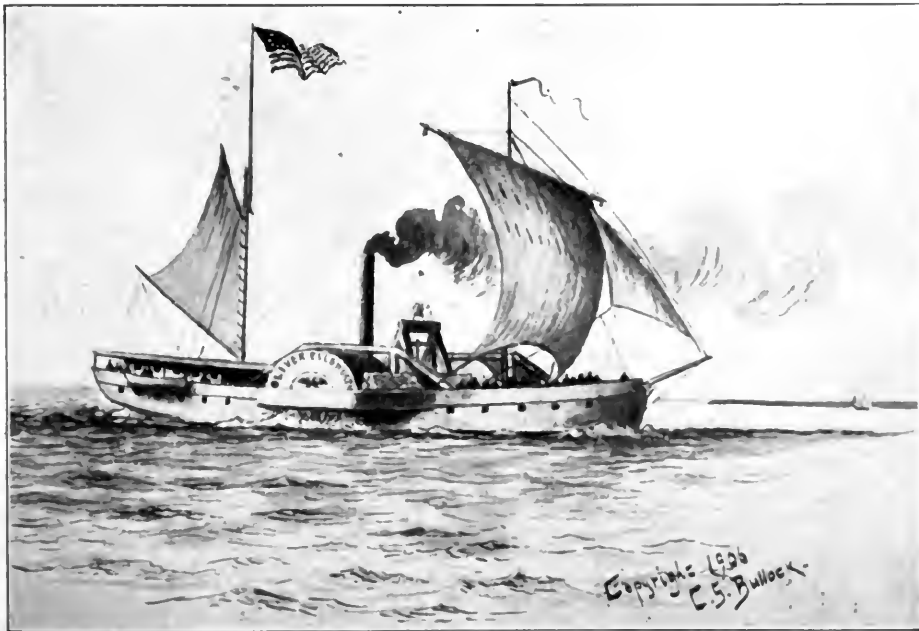

THE "OLIVER ELLSWORTH" BUILT IN 1834—ESCORT AT OPENING OF ERIE CANAL
 This was one of the first steamboats to have a large iron boiler—It exploded in 1827, causing much excitement—The legislature was in session in Connecticut, and the post-rider leaped from his lathered horse and broke into the assembly hall shouting: "The Oliver Ellsworth biled her buster!"

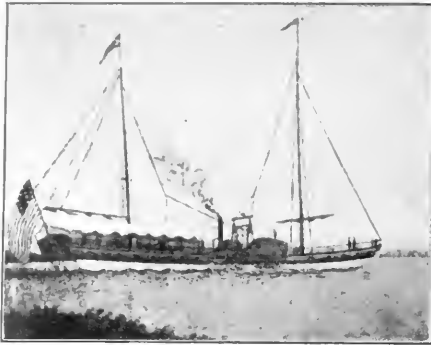

FIRST STEAMSHIP TO SAIL ON THE OCEAN
 "Phoenix" left New York, June 8, 1809—Arrived at Philadelphia on the 17th—From Oil Painting in the Stevens Castle at Hoboken, New Jersey



ESCORT TO LAFAYETTE IN AMERICA
 "Chief Justice Marshall" in Great Naval Parade on the Hudson and received an ovation from the throng—Lost in terrific gale on April 28, 1835

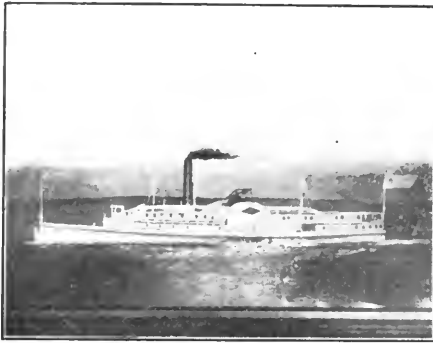

MAIL CARRIER BEATEN BY RAILROADS
 "Traveller"—Built in 1845—Owned by Commodore Vanderbilt and famed for her fast postal service



FINEST DAY BOAT FROM NEW YORK IN 1832
 "Splendid"—One of first "floating palaces" on Long Island Sound - Noted for speed and size

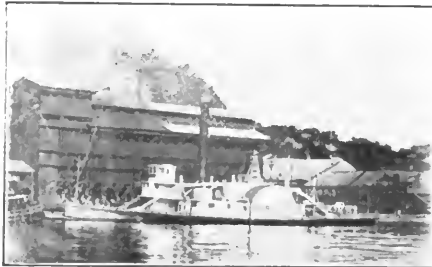

OLDEST STEAMBOAT'S LONG SERVICE
 "Norwich"—Built in 1836 and remaining in active commission until its destruction last year

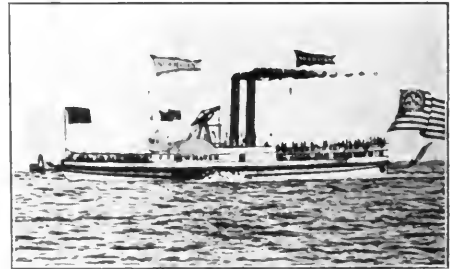

DICKENS' "RUNAWAY BATH HOUSE"
 "New York"—Built in 1836 and described by the Distinguished Tourist in his "American Notes"



ONE OF FIRST BOATS TO USE GAS LIGHTS
 "Atlantic"—Built in 1846 and went down with fifty passengers in northwest gale six months later

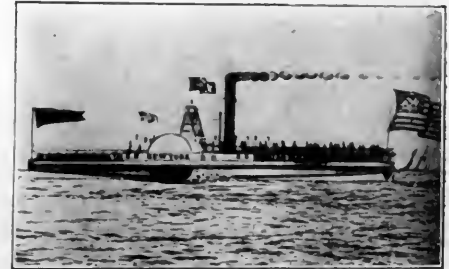

COMPETED WITH STAGE AND POSTBOY
 "New Haven"—Built in 1835—One of the early mail carriers in days of keenest rivalry



FITTED OUT TO FILIBUSTER IN CUBA
 "Cleopatra"—One of fastest steamboats in fierce traffic war of 1836—Apprehended by the Government when about to sail for the West Indies

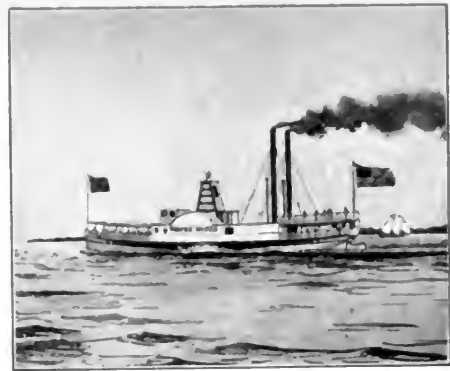

FIRST BOAT BUILT ON SUBSCRIPTION
 "Water Witch"—In 1832 there was a general uprising against the "steamboat monopoly" and the people organized to "break the trust"

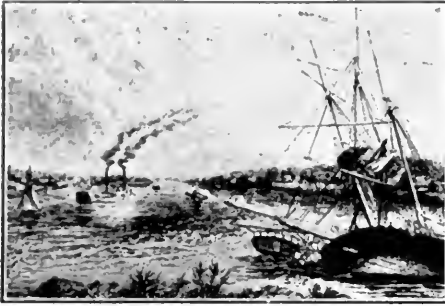

PASSING THROUGH HELL GATE IN 1825
 "Providence"—Old Lithograph showing steamboat leaving New York for her run down to Rhode Island

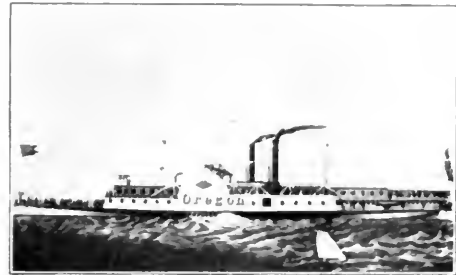

HELD WORLD RECORD DURING HER DAY
 "Oregon"—Built in 1845—George Law's favorite river racer—Wrecked in a collision in 1865



STEAMBOAT LEAVING NEW YORK IN 1824
 "Little Providence"—First single beam boat on Long Island Sound to have a visible "walking beam"



FROM BOSTON TO PORTS IN MAINE
 "Boston"—Built in 1831, and became a favorite for excursionists—From a rare print of 1840

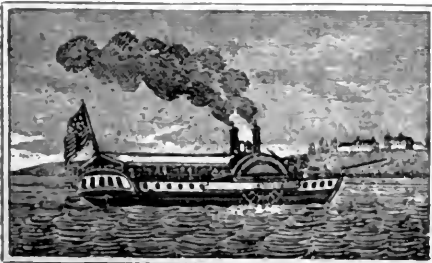

BUILT FOR EMPEROR OF RUSSIA IN 1818
 "Emperor Alexander"—Built to go to St. Petersburg but never attempted trip across the ocean

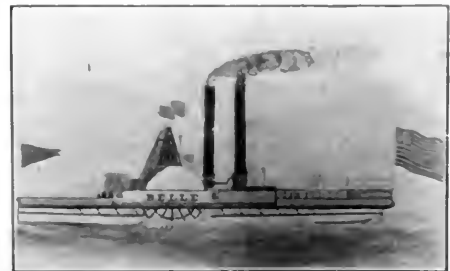

ONE OF THE EARLY RATE WARRIORS
 "Belle"—Built in 1837 and entered in the keen competition that reduced passage rates to minimum

First Steamship to Cross the Ocean

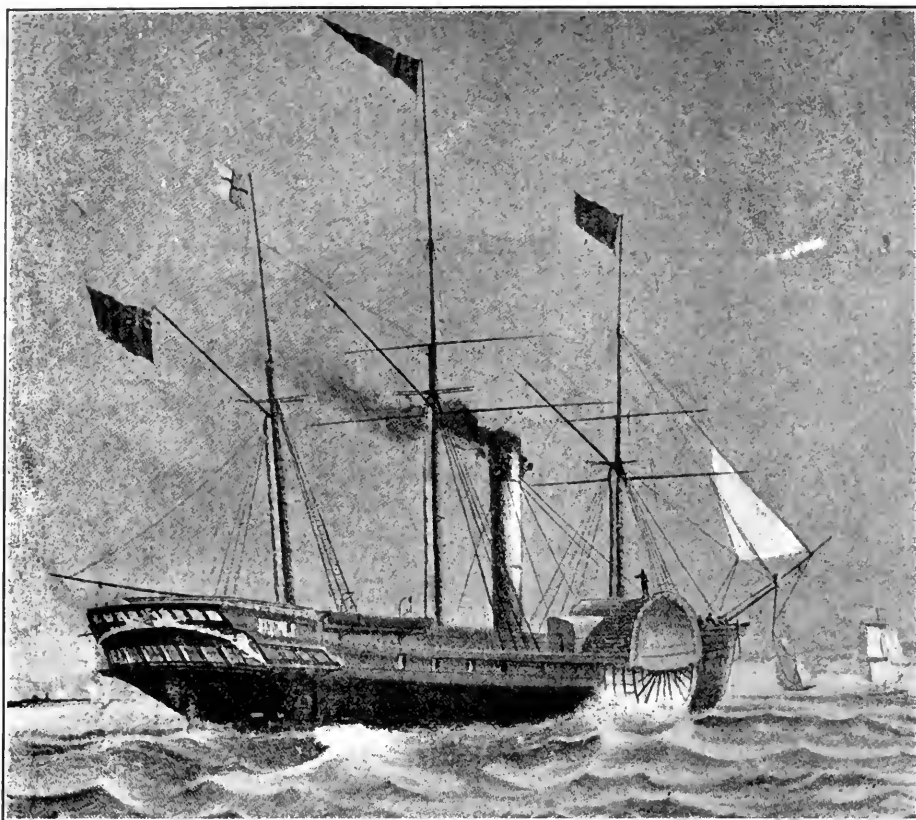

FIRST STEAMSHIP IN THE WORLD BUILT FOR TRANS-OCEANIC SERVICE

The "British Queen" sailed from Portsmouth, England, July 12, 1839, and arrived at New York, July 23, 1839—time—fourteen and one-half days—Built by Junius Smith after much difficulty in securing capital for the "chimerical and foolhardy" project—From rare aqua-tint of 1838

The real genesis of steam navigation so far as it pertains to the ocean, must be set down for the year 1838 when Junius Smith succeeded in interesting English capital in a project for building a line of steamships for ocean service.

The pioneer ocean steamship promoter, Junius Smith, was born at Plymouth, Connecticut, October 2, 1780, and studied law at Yale. While on a voyage from Liverpool to New York, where he then had his home, he thought of the immense benefits to be gotten from the use of steam upon ocean vessels. John Fitch had foreseen it. Others had thought of it, but with Junius Smith

it became more than thought. He was the son of General David Smith who was born in Lebanon, near Norwich, Connecticut, December 2, 1747 (O. S.), and his mother was Ruth Hitchcock Smith, of Suffield, who was born March 4, 1750 (O. S.). He died at Astoria, New York, January 23, 1853, and shortly after his death there was brought to light a letter that he had written to Cyrus W. Field relative to the laying of the Atlantic cable and setting out in detail his earliest experiences in trying to interest men of means in the question of steamships for the ocean. None of the New York merchants would have anything to do with the chimerical

Beginning of the World's Commerce

scheme and in 1833 he turned to one of the directors of the London and Edinborough Steam Navigation Company whose vessels were the largest then afloat. He received no encouragement from this quarter—the proposition of trans-oceanic steam commerce seemed too visionary for those practical men. Smith then tried to charter a ship to open a line under his own name but no one could be found who cared to risk a boat for such a foolhardy undertaking. In 1835 he published a prospectus of a joint-stock "Steam Navigation Company" but no one would buy a share.

Those who did not ridicule and oppose every step of the undertaking stood suspiciously aloof and refused to give countenance or support to the project. When an audience was sought with the Duke of Wellington, he replied through his field-marshal:

"The Duke of Wellington presents his compliments to Mr. Smith. The Duke has no leisure to receive the visits of gentlemen who have schemes in contemplation

for the alteration of the public establishments."

To show the intellectual grasp that this pioneer, who advocated doing away with masts and spars entirely for steamships, one has only to read his letters in 1838 to Professor Benjamin Silliman, of Yale, who opposed his views and almost implied that he was crazy. One letter reads as follows:

"The United States of America, stretching around half a continent with a sea-coast scopped into numberless bays, harbours and inlets, with a government bearing rule over a people almost too independent to submit to any, urged on by ambition, vain of their acquirements and proud of their country, is nevertheless slumbering in dangerous security. To such a people the power of steam, as a means of national defence, is of incalculable value. But do they perceive it, or will they slumber on until their cities, towns and villages are battered about their ears? Do they think that the golden images of successful avarice set up in every part of the country are no temptation to the dar-



SECOND STEAMSHIP TO REACH AMERICA FROM THE OLD WORLD

The "Great Western" sailed from Bristol, England, April 8, 1838, and arrived in New York April 23, 1838—fifteen days later—Cannons from forts and warships boomed as she sailed into gateway of the New World's astonished metropolis—From an oil painting by Walters in 1838

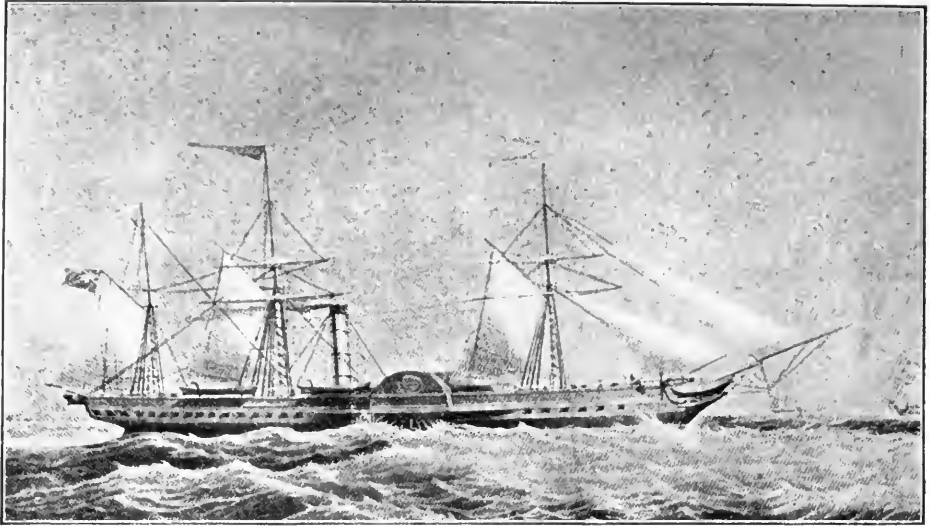

FIRST STEAMSHIP OF CUNARD LINE FROM LIVERPOOL TO BOSTON
 The "Britannia" made her first trip in 1840. It was on this ship that Dickens experienced the storm at sea described in his "American Notes," speaking of the many perils of the new science

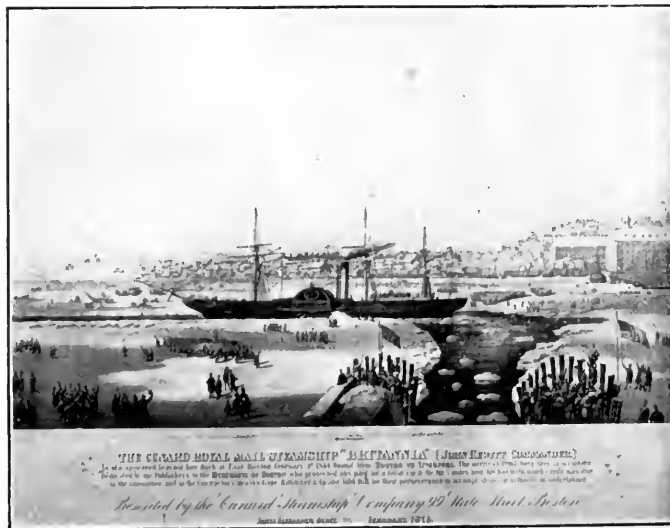

"BRITANNIA" ICE BOUND IN BOSTON HARBOR IN 1844
 From rare print in collection of Mr. Elisha T. Jenks of Middleborough, Massachusetts, showing steamship making her way through ice canal cut by citizens of Boston who came to her rescue

Beginning of the World's Commerce

ing buccancer? and do they not perceive that unless the means of protection correspond with the growth of the thing to be protected, the probability is that all may be lost?"

Nothing daunted, Smith steadily kept at the matter until he had the ear of someone unafraid of new things and a company was organized of men who dared to follow where someone more daring had opened the way. Contracts were let and the building of boats really begun. But before the first boat was ready for delivery an opposition company had sprung up and a date of sailing was announced. Not to be cheated out of the reward of their labors the original company organized by Smith chartered the "Sirius" which was running between London, England, and Cork, Ireland.

The "Sirius" was one hundred and seventy-eight feet long, twenty-five and a half feet wide, and eighteen and a quarter feet deep. She measured seven hundred and three tons. On the scales one "Sirius" would have more than balanced four "Clermonts" and in a tug-of-war the English boat would have been more than a match for thirty boats of the Fulton make, but judged by the standards of to-day, what an insignificant thing was the "Sirius." She was built by Menzies, of Leith, and engined by Wingate & Company of Whiteinch, near Glasgow, Scotland. Her paddle-wheels were twenty-four feet in diameter, and were turned by a side-lever engine with a five-foot cylinder and a six-foot stroke. It is an error to say that the "Sirius" steamed from London to New York in eighteen and a half days. She recoaled at Cork and sailed thence on April 14, 1838, and was eighteen days on the trip. She came into New York at ten o'clock at night, April 22, 1838, having been caught on a mud-bank as she came into the harbor where she was held till the rising of the tide.

She had been moored to the wharf only a few hours before the whole

town had heard of the arrival of "a wonderful thing that streamed across the ocean and tied up to Jones's Wharf." The sailors of the waterfront lighted great bonfires and mingled with the crowds that gathered to stand and stare at the prodigy, and the next day the papers were full of the strange thing. No vessel before had ever dared to depend on steam alone for crossing the awful sea and this venturesome craft had used up all her fuel before she reached Sandy Hook so that it had been necessary to burn all her extra spars and forty-three barrels of rosin that she might enter the upper bay under her own steam.

In the *Marine News* there was an announcement of the arrival of the "Sirius" and an advertisement of her return trip, under a cut of the "Savannah," the only ocean-going ship with steam equipment of which there was a picture to be found anywhere. This advertisement read:

This vessel has superior accommodation, and is fitted with separate cabins for the accommodation of families to whom every possible attention will be given. Cabin, \$140.00, including provisions, wine, etc. Second Cabin, \$80.00, including provisions, wine, etc.

The "Sirius," whose crew mutinied when she was a few days out and declared it utter madness to go farther on so small a craft, was commanded by Lieutenant Roberts, of the Royal Navy, who was afterward lost with the "President"—the first steamship to sail through the mists that hide the shores of the uncharted sea, whose trackless waters give back no tidings of the ships they bear. On the return voyage the "Sirius," whose boiler had its safety limit for steam set at fifteen pounds four hundred and fifty tons of coal for the entire trip. Yesterday I was reading that to generate steam for the turbines of the new sixty-eight thousand horse-power Cunarders, one thousand tons of coal

First Steamship to Cross the Ocean

will be consumed every twenty-four hours.

Among the passengers, on this daring trip across the ocean from New York, was James Gordon Bennett, the founder of the *New York Herald*, who often told with great relish of his experiences on board the first steamboat to sail from New York to Falmouth, a voyage that consumed eighteen full days.

But the honors of the "Sirius" were not long unchallenged. Four days after she had sailed from Cork, the "Great Western" steamed out from Bristol, England, carrying six hundred and sixty tons of coal and having on board seven passengers. The two boats followed practically the same course, but the "Great Western" was the superior boat in every way and outsailed her rival. In spite of the longer distance that she had to travel, the "Great Western" arrived in New York but a few hours after the "Sirius." At three o'clock on the afternoon of April 23, 1838, the booming of cannon on board the men-of-war in the harbor and in the forts that guard its approach, announced the arrival of the second steamboat from the Old World.

The "Great Western" at once caught the fancy of the public. She was two hundred and thirty-six feet long; the "Sirius" was one hundred and seventy-eight feet. The latest arrival was a one thousand, three hundred and forty ton boat; the other measured only seven hundred tons. The best speed of the "Sirius" was one hundred and sixty knots a day but the "Great Western" had sailed two hundred and forty knots. The keel of the "Great Western" was laid in 1836 but not a penny of American money found its way into the enterprise.

Can it be that an unfounded fear of the deep has kept back American interest in steamships even till to-day so that after building the fastest and best sailing vessels that the world ever knew we have suffered our shipping

interests to pass into other hands? Must we wait until some nation with a merchant marine to supplement its navy threatens us with war before we shall awaken to the fact that we have been playing "penny wise and pound foolish" in our niggardly treatment of this most important feature in the defence of a nation? With such an extent of impregnable sea-coast it is impossible to offer resistance to the approach of a hostile fleet unless there shall be swift merchant ships to cooperate with the more ponderous men-of-war.

In the beginning of oceanic steam service, the two voyages that I have described inaugurated an era of transportation that has ever been changing for the better. First came the change from sails to wooden paddle-wheels for speed; then from wood to iron hulls for strength, in 1843; next from the paddle-wheels to the screw, for economy, in 1856; then from simple to compound engines to save fuel, in 1856; next from iron to steel hulls to gain stiffness and save weight, in 1879; then from the single to the twin and triple screw for safety and speed, in 1889; and finally, to the turbine.

After her return to England the "Sirius" was again put on the route between London and Cork, as she was thought to be too small for the trans-Atlantic service, where she was eventually lost, but the "Great Western" continued to sail between the Old and the New World for a number of years and was finally sold to the Royal Mail Line in 1847 and was broken up in 1856.

The "Great Western" made seventy trips across the Atlantic during her stay on the New York-Bristol Line, averaging fifteen and a half days for the westward passage and thirteen and a half days for the eastward run. The quickest trip was made in 1842 when the passage from New York was accomplished in twelve days and seven hours. This was most remarkable sailing and stood as the record for some time but we must not forget

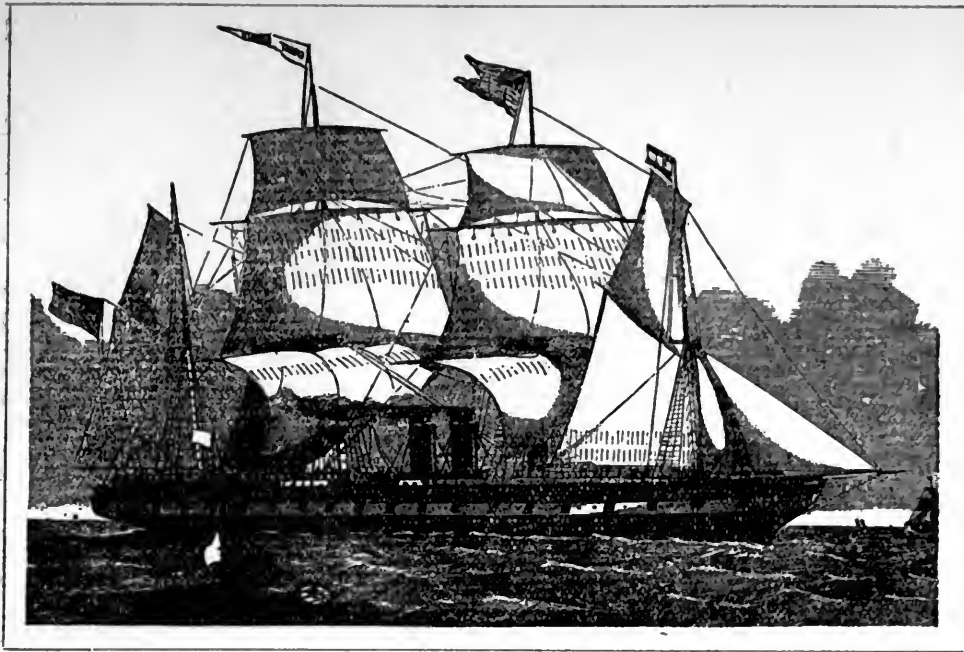

GREATEST OCEAN GREYHOUND OF 1842—"THE GREAT BRITAIN"

To forge her main shaft the world was given a new invention—She went ashore off coast of Ireland without suffering serious injury, and many years later was engaged in Australian trade—This ship was the marvel of her time—From an old print taken after the alterations in 1852

that the clipper "Dreadnaught" had made a trip from New York to Queenstown in nine days and seventeen hours and as late as 1846 the clipper "Tornado" of the Morgan Line beat the Cunard steamer across from Liverpool, arriving in New York before the steam-propelled craft arrived in Boston. It was not an uncommon thing then to find a sailing ship advertised under a guarantee to reach the destination before the steamship or forfeit the money paid for passage.

The speed of the old "Sirius" was about six knots an hour and the "Great Western" was somewhat faster. But who at that day ever dreamed that any future ship would make a trip from New York to Queenstown under an average hourly speed of 23.58 knots an hour, the best time of the modern "Kaiser Wilhelm II," or cover six hundred and one knots in twenty-four hours, an average of 24.19 knots an hour, the best

time of the fleet "Deutschland" which stands as the fastest day's run ever made by any ship? The contract speed of the new Cunarders is to be 25.50 knots an hour and if it shall ever prove practical to build a boat that can make thirty knots an hour—and in view of what has been accomplished in less than seventy years who shall say it is not among the really probable things—it will be possible to eat one's dinner in New York city on Saturday noon and the mid-day meal in Queenstown the next Wednesday.

When the "Sirius" was withdrawn from the trans-Atlantic service her place was taken by the "British Queen," which was built by Gerding and Young of London and was to have been called "Victoria," but upon the accession of England's most glorious queen the new boat was given a new name. Her keel was laid April 1, 1837, and the contract for the engines let to a firm that gave every

First Steamship to Cross the Ocean

promise of meeting all the demands. After receiving £6,000 sterling this firm failed and as no other firm could be found that would agree to take up the work where they left it, a new contract was made with Napier and Company. This caused a delay of nearly a year and was the reason for the chartering and dispatching of the "Sirius."

The "British Queen," which had cost £90,000, exclusive of the machinery which cost £24,000, was two hundred and seventy-five feet long, thirty-seven and a half feet wide and twenty-seven feet deep. Her paddle-wheels were thirty feet in diameter, made of iron and the strongest oak. She sailed from London on July 11, 1839, the passengers embarking at Portsmouth on the twelfth and was under steam at twelve-thirty noon. At two o'clock Sunday morning, July twenty-eighth, she was at Sandy Hook, thus making the passage in fourteen and a half days. On August first, at two o'clock, she started back for the return trip and on August fourteenth she took her English pilot aboard, thus making the run from pilot to pilot—New York to Portsmouth—in thirteen and a half days.

The same company that had sent out the "Sirius" and built the "British Queen" now added the ill-fated "President" which first sailed from the Mersey, June 17, 1840. The "British Queen" was advertised as sailing from London and the "President" from Liverpool. After two or three successful trips this beautiful craft sailed out from New York Harbor March 11, 1841, and was never heard from again, save that she had been sighted by a passing vessel a few days after sailing and an entry on the log of the brig "Poultney," sailing from New York to Smyrna, stating that she had passed "a large piece of wreckage, sixty feet long and thirty to forty feet wide, that looked like the broadside of a steamboat, the main-channel having four dead-eyes, with turned mouldings

and long iron straps. Her hull was black with a broad white streak and large, painted ports. There was a bight of hawser over a piece of wood apparently a part of the guards." Those who knew the boat read in this description of floating wreckage her probable fate and whatever of hope might have lingered in any breast was dispelled when Captain Jensen, sailing from the Cape Verde Islands in the schooner "Moniko," brought in an account of the finding of the stern-boat of the ill-starred craft and the picking up at sea of several casks bearing the name "President," which name was also found on several other casks that had drifted ashore on St. Nicholas, one of the Cape Verde group.

The loss of the "President" and the subsidy granted the new Cunard Line brought about the financial collapse of the British and American Steam Navigation Company and the remaining boat, the "British Queen," was sold to the Belgian government, and ultimately found her way into the hands of the Oriental Company and ran between Falmouth and Alexandria. Her best time was made on the voyage that began April 5, 1842, when she crossed from New York to Portsmouth in 12.85 days.

The first boat of the Cunard Line was the "Britannia" which sailed from Liverpool for Boston on July 4, 1840. A stop was to be made at Halifax and for this service the English government paid a substantial subsidy. Four vessels were built for the company, having an aggregate tonnage of 4,600 tons and a speed of less than eight knots an hour. The "Britannia" was two hundred and seven feet long, thirty-four and a half feet wide and twenty-two and a half feet deep. Her paddle-wheels were twenty-eight and a half feet in diameter and were turned by the common-type "side-lever engine" which was first given a standard form by Maudsley & Company of London, about 1835.

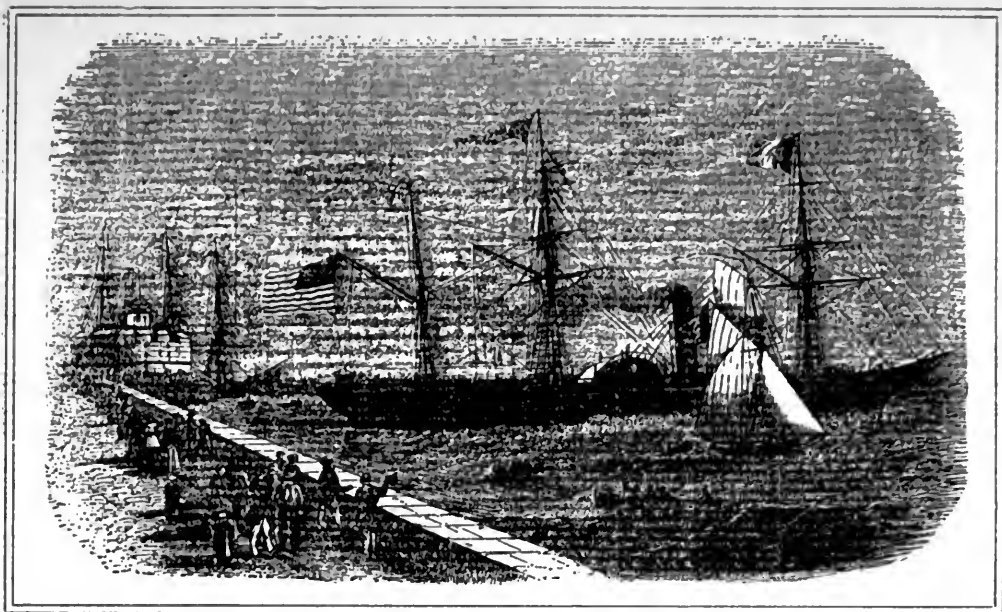

FIRST AMERICAN STEAMSHIP TO CARRY MAIL TO FRANCE

The "Franklin" subsidized by the Government in 1849 at \$150,000 per annum to carry mail between New York and Havre on fortnightly service—Average time twelve days ten hours—Lost off Montauk Point, Long Island, July 17, 1854, during tempestuous voyage—From an old print

It is the "Britannia" that our cousin "Boz" describes in his American Notes. No such description of a ship in a storm ever came from any other pen:

It is the third morning. I am awakened out of my sleep by a dismal shriek from my wife, who demands to know whether there's any danger. I rouse myself, and look out of bed. The water-jug is plunging and leaping like a lively dolphin; all the smaller articles are afloat, except my shoes, which are stranded on a carpet-bag high and dry, like a couple of coal-barges. Suddenly I see them spring into the air, and behold the looking-glass, which is nailed to the wall, sticking fast upon the ceiling. At the same time, the door entirely disappears, and a new one is opened in the floor. Then I begin to comprehend that the state-room is standing on its head.

Before it is possible to make any arrangement at all compatible with this novel state of things, the ship rights. Before one can say "Thank Heaven!" she wrongs again. Before one can cry, "She is wrong!" she seems to have started forward, and to be a creature actively running of its own accord, with broken knees and failing legs, through every variety of hole and pitfall, and stumbling constantly.

Before one can so much as wonder, she takes a high leap into the air. Before she has well done that, she takes a deep dive into the water. Before she has gained the surface, she throws a somerset. The instant she is on her legs, she rushes backward. And so she goes on, staggering, heaving, wrestling, leaping, diving, jumping, pitching, throbbing, rolling, and rocking, and going through all these movements, sometimes by turns, and sometimes all together, until one feels disposed to roar for mercy.

Such was the comedy side of his experience. In a letter to his friend and biographer Dickens shows the more serious side. To him he wrote:

Of course you will not see in the papers any true account of our voyage, for they keep the dangers of the passage, when there are any, very quiet. I observe so many perils peculiar to steamers that I am still undecided whether we shall not return by one of the New York liners. On the night of the storm I was wondering within myself where we should all be if the chimneys were blown overboard, in which case, it needs no great observation to discover, that the vessel must be instantly on fire

First Steamship to Cross the Ocean

from stern to stern. When I went on deck the next day, I saw that it was held by a perfect forest of ropes, which had been rigged in the night. Hewitt told me, when we were ashore, not before, that they had men lashed, hoisted up and swinging there, all through the gale, getting those stays about it. This is not agreeable is it?

This reminds me of a good old Scotch captain who has recently cast anchor in the Harbor that is never ruffled by the winds of storm. On one of his roughest voyages this old sea-salt had under his care a very reverend gentlemen of the "Established Kirke" and a party of youngsters who were not at all reverent. During the worst of the bad weather the former had shown himself to be decidedly nervous and on one occasion had so bothered the captain and the crew when they were tightening some ropes that the captain in self-defence had given him the dead end of a rope and told him to hang onto it as if his very life was at stake. When the crew had finished their task the reverend gentleman was relieved of his duty with the thanks of the captain and an aside to the crew that it had kept the "Sky Pilot" out of the way for half an hour anyway. As the fury of the gale increased the captain had occasion to pass through the cabin where the "reverend" sat in prayer and the irreverent sat at a game of cards. The clergyman appealed to the captain for an assurance that the ship was still safe. "Presairve us, mon," he replied disgustedly, "but I do believe you're mair afeard to go strecht to heaven than these young cubs be to go strecht to hell."

Fear of travel by steamboat was not simply among the "laity." The learned Dr. Lardner, however wrongly he may be accused of declaring that a steamboat could never cross the ocean, was at this time doing all in his power, both with tongue and pen, to dissuade men from embarking in so foolish an undertaking as the establishment of a line of steamships to

regularly ply between the two worlds. On every hand it was pointed out that the objections "could only be regarded as neutralizing to a certain extent the benefit, if any, of the scheme." The *London Civil Engineer and Architect's Journal* said:

Another formidable objection to Atlantic steam-voyaging arises from the overwhelming force of the Atlantic storms. The shock of masses of water roused into a most violent commotion by the accumulated momentum of every wave in the whole three thousand miles of foaming waters is nearly irresistible, and is productive of the most injurious effects to vessels of large dimensions impelled by immense steam-power. We ourselves happened to see the "Liverpool" in dock after exposure to one of these Atlantic storms, and she was really little better than a wreck. . . . The "British Queen" it is well known has been injured on several occasions and the frames of the engines of the "Great Western" have been all broken by the working of the ship.

The whole matter was dismissed with the words:

The establishment of steam-communication with the moon is quite as feasible—"Earth has its bubbles as the water hath, And this is of them."

However, the companies that had been organized went steadily forward and ordered new and larger ships.

In 1842, came Brunel's "Great Britain" which was described in the prints of the day as a "huge leviathan." Her engine developed 1,500 horse-power, or three and three-quarters times more than that of the "Great Western." To forge her main shaft the world was given a new invention—the Naismith steam-hammer. The hull was of iron and the whole ship was an embodiment of the best skill in designing and workmanship of that time. On Tuesday, September 22, 1846, the "Great Britain" left Liverpool for New York with 180 passengers—the largest list ever carried by any one ship up to that time. At 9:30 that night she struck on the sandy beach of Dundrum Bay

Beginning of the World's Commerce

where she lay for several weeks without having suffered any serious injury—a remarkable illustration of the stability with which the work was put together. After some slight repairs she was again put on the route and many years afterward was still afloat and engaged in the transportation of passengers and merchandise to Australia and ran as a steamship till 1876. At last accounts she was lying at the Falkland Islands as a coal hulk.

As first built the "Great Britain" was decidedly different from the boat that became so generally known. She then had five masts, four of which were hinged at the trunnion to lower in heavy weather, and was a "side-wheeler." Though designed by the builder of the "Great Eastern," who had been associated earlier with the Stevens's in building the first steam-boats in the world, she was a failure and for months lay up as a "wreck in port." But she passed into other hands and was refitted for service. The side-wheels and one of the masts were removed and two oscillating engines, of five hundred horse-power, were installed. As a side-wheeler she had an extra weight of one hundred tons—that is, the wheels and the connecting machinery weighed one hundred and eighty tons. As a propeller the total weight of the wheel and the machinery was but eighty tons.

But it was not long before the "Great Britain" was superseded by bigger, faster boats. Ships with compound engines were built which left those of the old single type far behind. The "Bothnia" was the first compound Cunarder, and when she crossed the ocean with an average speed of thirteen knots, carrying 340 passengers and 3,000 tons of cargo, she was for a time called the "Queen of the Atlantic." The "Great Eastern" came before her day, though she proved a failure in trying to combine sidewheels and propeller, she solved many problems which have been of subsequent aid to the ship-

builder. In many characteristics the "Great Eastern" was unmatched for years. Her displacement of 27,000 tons was not surpassed until the arrival of the 28,500 ton "Oceanic." And her depth of fifty-seven and a half feet and beam of eighty-three feet would still remain the record figures were they not exceeded by the new Cunarders, which are sixty feet deep and eighty-eight feet wide, and which accordingly surpass any vessels ever built.

To show how transitory is the prestige of the trans-Atlantic flyer the following are named, with the date that each beat the record of its predecessor: Persia, 1856; Scotia, 1866; City of Brussels, 1869; Baltic, 1873; City of Berlin, 1875; Germanic, 1876; Britannic, 1877; Arizona, 1880; Alaska, 1882; Oregon, 1884; America, 1884; Etruria, 1885; Umbria, 1887; City of Paris, 1889; Majestic, 1891; Teutonic, 1891; Campania, 1893; Lucania, 1893; Kaiser Wilhelm der Grosse, 1897; Deutschland, 1900, and Kaiser Wilhelm II, 1904.

And in this race for supremacy every mechanical factor has been developed as far as engineering skill would permit. As the single engine was followed by the double engine, so the double engine has been succeeded by the quadruple. The single screw gave way to the twin screw boat, and now, with the "Mauretania," the four screw ship has come. Indeed, it would seem that the prophecy of the late Lord Inverclyde, head of the Cunard Company, would some day be realized—that the steamship of the future would have propellers all along its bottom, and that it would exceed in speed even the fastest express trains.

So gradual, however, has been the development of the steamship that the people of to-day fail to realize how tremendous it has been. The great monarchs of the deep come in and go out of New York Harbor, but so long as no accident happens to them the city pays little heed. What business

First Steamship to Cross the Ocean

man to-day leaves his work simply to look at an arriving transatlantic liner? The day when the whole town rushed down to the water-front to stare at the "Sirius" will doubtless never be repeated. No matter how big or how fast may be the ships of the future they will never arouse the excitement and the curiosity of those early days.

In 1844 Boston Harbor was frozen solid. The citizens, fearing that the terminal of the line might be changed to New York, cut a channel up to the very wharf.

In those early days it was the custom to carry live sheep and cattle that were butchered on board as needed for food. A stall for cows was also one of the adjuncts of a ship. Think of what a herd of Jerseys it would require now to furnish the three thousand quarts of milk and cream used on an ordinary passenger ship on a single trip across the ocean! A glance at the deck plan of the "Britannia" will show the arrangement of the slaughter-house and the cow-stall.

Think of what it means to speak of a sixty-eight thousand horse-power engine, such as is planned for the new Cunarder turbines. If the sixty-eight thousand horse-power engine were to be replaced by sixty-eight thousand horse-power of human muscles, there would have to be three relays of men at the treadmill, or whatever other appliance would be used. Each eight-hour shift would require six hundred and eighty thousand men and for the three shifts there would be two million and forty thousand men—a population below deck larger than that of any city of the world except London. If the problem were to give the ship the high speed of the railway locomotive the figures would vanish in the unthinkable. The piston speed in 1838 was not more than two hundred feet per minute. In 1860 it had reached four hundred feet and to-day a speed of more than a thousand feet is common.

Strange as it may seem, the United States, after having first solved the

practicability of the steam engine has had but little to do with its development upon the ocean. Other countries have been quick to see the value of a merchant marine and have given large bonuses as an inducement to both brains and money, but we have lagged away behind. During the year 1903 not one American ship entered or cleared from a single port in Germany, Russia, Sweden, Norway, Denmark, Austria-Hungary, Greece, or the Netherlands. With the largest export trade of all the nations and the greatest extent of navigable coast line, we have the smallest merchant marine.

Last year we paid \$200,000,000 in freights to ocean ships and carried only seven per cent of it in American vessels, the balance, or \$186,000,000, going into the treasury of foreigners. In 1821 we carried eighty-three per cent of our foreign commerce. In 1903 we carried only seven per cent and the total volume of our commerce had increased twenty-fold. Can we stand this forever?

The first steamers built in this country to cross the ocean were built for foreigners. This was in 1841 and the two boats were at first known as the "Lion" and the "Eagle" but when they went into the Spanish navy they were called the "Regent" and the "Congress." At about the same time the "Kamschatka" was built by W. H. Brown, of New York, for the Russian navy and our engineers were at work on the "Missouri" and the "Mississippi," much larger vessels, for our navy.

The first American steamship owned or run by an American company in transportation to or from any European port was built in 1847 when the Ocean Steam Navigation Company had two boats built by Westervelt and Mackay, at New York, which they named the "Washington" and the "Hermon." They ran to Bremen, touching at Cowes, under a contract with the United States to carry mail for \$200,000 per

Beginning of the World's Commerce

annum. The postage on letters to Europe at this time was twenty-four cents for one-half ounce or less, forty-eight cents for anything between a half ounce and an ounce and fifteen cents for every additional half ounce. Newspapers and pamphlets were carried for three cents each. Ten years later Congress refused to renew the contract, made no appropriation to cover the transportation of foreign mails, and the company was compelled to withdraw its vessels from the service.

In the same year, 1847, that the "Washington" began her trips, Charles H. Marshall & Company, owners of the famous "Black Ball" line of packets running from New York to Liverpool, gave a contract to William H. Webb to build the steamship "United States." This vessel made but one round trip and not proving a success as to payability was sold to the Prussian government and turned into a steam frigate but afterward found her way into the merchant service where she plied for years.

In 1849, the New York and Havre Steam Navigation Company was also given a contract by the government to carry mail between New York and Havre, touching at Cowes, for which they were to receive \$150,000 per annum for a fortnightly service, and built the "Franklin" and the "Humboldt." The average time of the line to Havre was twelve days and ten hours. The line to Bremen had an average of fourteen days and nine hours. The two boats on the Havre line continued in service until they were lost—the "Humboldt" in entering the harbor at Halifax, December 5, 1853, and the "Franklin" off Montauk Point, Long Island, July 17, 1854. Two vessels were chartered to take their place until the "Arago" and the "Fulton" were built, in 1855, which continued on the run till 1861 when they were chartered by the United States government service in the war.

The next line to carry the American flag was the famous Collins Line, under the corporate name of "The New York and Liverpool U. S. Mail S. S. Co." The paid-in capital of the company was \$1,200,000 and four vessels were built from models made by George Steers, the designer of the yacht "America." The first, the "Atlantic," was built in 1849 by William H. Brown; the second, the "Pacific," was built the same year by Brown and Bell. In the next year two others, the "Arctic" and the "Baltic," were built by the same firms.

A description of the "Atlantic" from a contemporary magazine will show what magnificent vessels were placed upon this line:

The "Atlantic" is two hundred and seventy-six feet on the keel and forty-five feet wide. The stem is rounded and has in the center the American eagle clasping the star and striped shield but no other device. . . . There is a colossal figure head at the bow. . . . A house at the stern contains a smoking-room, and a small compartment completely shelters from the weather the steersman. . . . This smoking-room is the principal prospect of the man at the helm, who, however, has to steer according to his signals. Before him is a painted intimation that one bell means "port" and two bells mean "starboard;" a like intimation appears on the large bell in the bow of the ship. According to the striking of the bell, so must he steer. . . . The great saloon below deck is sixty-seven feet long and the dining-saloon is sixty feet long; both are twenty feet broad and are separated from each other by the steward's pantry. Panels containing beautifully finished emblems of each of the states in the Union and a few other devices that savor very strongly of republicanism are on every side. For example, a young and beautiful figure, all radiant with health and energy, wearing a cap of liberty and waving a drawn sword is represented as trampling on a feudal prince from whose head a crown has rolled in the dust. The cabin windows are beautifully painted glass embellished with the arms of New York and other cities in the states. Large circular glass ventilators reaching from the deck to the lower saloon are also richly ornamented while handsome mirrors multiply all this splendor. . . . There are one hundred and fifty berths . . . the most novel feature about them being the "wed-

First Steamship to Cross the Ocean

ding-berths," which are wider and more handsomely furnished than the others, intended for such newly married couples as wish to spend the first fortnight of their honeymoon on the Atlantic. Such berths are, it seems, always to be found on board the principal river steamers in America, but as yet are unknown on this side of the water.

The line started under a contract to carry the United States Mail for \$385,000 per annum and this was afterward increased to \$858,000, yet the great expense of pushing the vessels at a rate of speed beyond anything that had ever been attempted before and the necessary repairs that such an undertaking involved kept the line from becoming anything like a paying investment. Before a solid foundation had been reached the government subsidy was withdrawn and the company that had in it more of promise for the future of the country than any other single enterprise was forced to the wall. The loss of the "Arctic" had crippled the finances of the company but it is more than probable that it would have been able to weather the storm if the interests of the South and Southwestern states had not united to cut down all the appropriations recommended in Congress that were in any way to be construed as being inimical to their demands. Thus the line received its death-blow—virtually killed in the house of its friends.

The first American screw steamship to cross the Atlantic was the "Pioneer" which sailed from New York to Liverpool in October, 1851, which was followed the same year by the "City of Pittsburgh." Out of the line that despatched the "City of Pittsburgh" came the Inman Line which in later years ran some of the best boats to be found upon the ocean.

New York capitalists built the "Ericsson," in 1853, to test the use of hot air instead of steam as a motive power. The "Caloric Ship" was a failure and her engines were removed for the installation of the much abused steam engines. After the

change this boat ran for some time on the Collins line to Bremen and was later sold to Boston parties who removed the machinery and converted her into a sailing-vessel for the East India trade. As an illustration of much advertising and little real merit the hot-air engine of Ericsson has its counterpart in the "liquid air" projects of to-day.

Commodore Vanderbilt made a proposition to the Post Office Department in 1855 to run boats alternately with the Collins Line for \$15,000 a trip if the speed of the Cunard Line was to be taken as a basis for sailing and \$19,250 a trip if the speed of the Collins Line was to be maintained. Congress rejected the proposition, as it did a later one, to carry the mail to Southampton and Havre for \$16,680 a trip, the rate paid the Cunard Line by the English government. The next year he ran the "North Star" and the "Ariel" to Bremen for two trips and in 1857 the "Vanderbilt," "Ariel" and "North Star" were put on the run. But there was no money in the undertaking and it was abandoned.

No other steamship line carried the American flag until after the close of the war when the Ruger Brothers and their associates started the North American Lloyds, but this enterprise also proved a failure. Another attempt was made in 1867 and still another in 1868 but both went as their predecessor had gone.

In 1871 the Pennsylvania Railroad Company, wanting to increase the foreign business of the line, was instrumental in the organization of the American Line whose vessels during 1875-8 made some very remarkable time. In 1884 this line was merged into the International Navigation Company, which in 1886 gained control of the Inman Line.

Between 1838 and 1879 there were one hundred and forty-four steamers, counting all classes, lost at sea while engaged in trans-Atlantic service. Perhaps the most noted of all was the

Beginning of the World's Commerce

"President," to which I have referred. Since 1879 the most memorable Atlantic ocean disasters would make a list, including the burning at sea of the "Egypt," of the National Line, and the "City of Montreal," of the Inman Line, both without loss of life; the stranding of the "State of Virginia," of the State Line, on the quicksands of Sable Island which quickly entombed her; the sinking of the "State of Florida," of that same line, by collision with a sailing ship; the disappearance of the National Liner "Erin," which is supposed to have foundered at sea, and the sinking of the magnificent "Oregon" of the Cunard Line off Fire Island through a collision with a coal schooner.

From these beginnings, and upon these tragedies, built upon the persistence of Junius Smith, the great commerce of the nations has developed; the gateways of the world have been thrown wide open; the continents, which were literally as far away from one another as the planets, have been drawn together until to-day the peoples of the earth are all near neighbors. The "sound-headed" American business men pronounced the plan to establish trans-oceanic service as "chimerical" and refused to invest in the "impracticable project."

Progress in every line of the world's work has been made against public opinion and in the face of public ridicule. Such is the way of human nature. How many of the present day "masters of finance," whose chance and daring have accumulated colossal fortunes, would invest in a

project to establish aerial navigation between New York and Liverpool? While aerial navigation is not as well advanced now as was steam navigation when capitalists disdained Junius Smith, it is fully as "tangible" as was steam navigation when John Fitch invited public attention to the possibilities of propulsion of vessels by steam. Are its inventors passing through the same experiences? Is "conservative" capital holding back the day of aerial navigation?

As I look on the tragedies of unfortunate men with "original ideas" I find that new epochs are opened only by the sacrifice of some genius who lays down his life as the price of progress.

I believe the fact has been fully established that John Fitch, not Robert Fulton, is the "father of steam navigation," but it is to Fulton that we also owe a great debt. It was his financiering that developed "the other man's ideas."

We have many John Fitches with their so-called "chimerical" ideas. They are haunting our patent offices with their "perpetual motions." They are wearing their lives away over their crude models only to find that the great world does not open its arms to "radical ideas."

We have multitudes of Dukes of Wellingtons who have "no leisure to receive the visits of gentlemen who have schemes in contemplation for the alteration of public establishments."

We need more Robert Fultons in American business.

We need more Junius Smiths to move the world along.

(From an Old Song)

"Rocked in the cradle of the deep,
I lay me down in peace to sleep.
Secure I rest upon the wave,
For Thou, O Lord, hast power to save.
I know Thou wilt not slight my call,
For Thou dost mark the sparrow's fall."

"And such the trust that still were mine,
Though stormy winds sweep o'er the brine,
Or though the tempest's fiery breath
Roused me from sleep, to wreck and death,
In ocean's wave still safe with Thee,
The germ of Immortality."

Trials in Early Justice Courts

Court Record

of Justice Jabez Brainerd

1773-1775 * Serious Crimes Included

"Profane Cursing and Swearing" * The "Gilty" were

Sentenced to Stocks and Whipping Post * Debtors Frequently

Bound Over to their Creditors in Servitude * Beginning of American Law

BY

REVEREND BERT FRANCIS CASE

IN POSSESSION OF THE ORIGINAL COURT RECORD

THE official doings of a Justice of the Peace in Revolutionary times is not without its points of interest and instruction. The book from which these records are taken belonged first to Justice Jabez Brainerd of Haddam and cover the years 1773-1775. Afterwards his son-in-law, Joseph Dart of Middle Haddam (town of Chatham), came into possession of the book—and he, with a very proper sense of economy, used the remaining blank pages to continue the story (with variations) which his father-in-law had so well begun.

In turning the pages of this ancient record it is assumed that whenever the name of a long-forgotten ancestor of the living reader comes into view, said reader will have a saving sense of humor.

There is no doubt that in those days considerable indulgence was shown the steady drinker, but, if he allowed himself to be carried by the enthusiasm of his calling beyond a certain point, some unfavorable comment was usually forthcoming. One of the first records concerns one Ben'm B——, who in June, 1773, was sternly required to confess a judgment against himself of "8 shillings fine for the sin of drunkenness and one shilling cost." A confession that Benjamin was persuaded

to repeat in December of the same year. Ready enough was Benjamin to confess but rather slow to pay up. We do not find his account adorned with the words "paid for," which is the encouraging foot note to the account of Abijah B——, Jr., who encountered a six shilling judgment the same year.

The breach of the Sabbath was regarded as a more serious offense, it would appear, than "profane cursing and swearing," or even the "sin of drunkenness"; for it brought a fine of ten shillings and one shilling cost to Hezekiah B—— of Middletown, in June, 1774, an offense and fine quickly repeated in the case of one Noadiah B——, who should have profited more by Hezekiah's experience—a thing, however, that man seldom does.

The same fruitful year also handed out a judgment of three shillings (paid) to one of the young B——s for "playing at meeting." The B—— horizon, it is true, had its gloomy aspects—yet hope dies hard—and it was Jacob B—— who conceived the brilliant idea of himself turning prosecutor. A neighbor was summoned to court to answer to a book account which Jacob triumphantly produced. His demand was only "twelve shillings Lawful money said to be Due by Book."

"The parties appeared," painstakingly records Justice Brainerd,

Court Record of Jabez Brainerd, 1773-1775

"and ware at Issue on the plea of owe nothing and ware fully Heard with there Evedances. In the Case and — this Court is of opinion that the Def'd Doth not ow the plaintiff in manner and forme as set forth in His Dicklaration and that the said Defendant shall Recover of the plantiff His cost taxed at £0, 06s, 07d."

But other equally adventurous spirits were abroad. Samuel Scovil was constable in Haddam in those days, and that meant something to Sabbath day travelers, though they seldom comprehended it in time. And be it also remarked Samuel Brooks was "one of the Grand jurors of our Sovereign the King." The two Samuels were an industrious pair—as three gentlemen from Middletown discovered when apprehended and fined five shillings apiece (Feb. 20, 1775), "for traviling on the Sabbath Day."

And it was just a week later that the watchful Samuel persuaded Charles Wright "of the provence and city of New York" to delay his journey long enough to deposit 5s Lawfull money and 2s charges for the benefit and use of the town treasury.

A very nice way of discharging a debt, when there was nothing to pay with—one of the common sense arrangements of ye olden time not without merit if it could be evoked by present day creditors—was that followed by "Joseph towner" of Haddam, in September, 1773. He held the note of "John Smith tailler, a transhant person," for "three pound eight shillings Lawfull money." The Def'd being unable to discharge the debt, having no money lawfull or otherwise, was assigned "in Servis to the said Joseph towner the terme of one year and six month." One only wonders what John Smith "tailler's" earning capacity was under favorable circumstances if it took 18 months of steady labor to pay a debt of 3£, 8s.

One of Haddam's established institutions that never attained any very wide popularity and for whose vacant places there was never any very brisk competition—was the stocks.

December 21, 1773, the case of Elisha C——, Jr., was under investigation. It would appear that some four months before the above date Elisha had been rather over enthusiastic in a celebration of some sort, and at last "two of the Grand Juriors of our Sovereign Lord the King," viz., "Charles sears and Abraham tyler" got busy in the matter. It was charged that Elisha was seen "Between His own House and the meeting House in s'd Haddam much Bereveed and Disinabled In the use of his Reason and Understanding appearing in his speech and Jestures and Behavior."

"Not Gilty," was Elisha's plea.

But when the "evidance for the King ware swore and gave in there evidences," the court said "Gilty." Whereupon the following choice was given Elisha: "To pay a fine of Eight Shilling Lawfull money to Be for the use and Benefit of the Town of Haddam, or "to set in the Stocks one hour."

An hour to be sure was only 60 minutes, and to sit still for 60 minutes was not a difficult feat; but for collateral reasons no doubt, it was not to Elisha's liking, so we have this simple foot note—"the fine and cost paid."

In May, 1774, one Amos D—— of "Dirham" was investigated. It was said that he did "swair Rashly and vainly By the Holy name of God on the 18 Day of April Last pas in the Highway near the Dwelling house of Jabez Brainerd in Haddam." On being adjudged "Gilty," he also is given a choice: A six shilling fine or a seat in the stocks for one hour and a half. History fails to reveal the choice that Amos made, but no doubt the state of his exchequer was a determining factor.

Trials in Early Justice Courts in America

One thing to be noted in the case of a not guilty verdict is that such a verdict did not always bring the comfort that was supposed to go with it. There is the case of Capt'n Abner P——.

In January, 1775 he was living in Waterbury, having removed from Haddam in September of the previous year.

In December, 1774, three of the King's Grand Jurors in Haddam—Dan'll Ventross, Ezera Tyler and Josiah Huntington—issued an "Information" against the Captain. Being much longed for and sent for the accommodating Captain consented to return to Haddam for a short time in January. It was averred that in the previous September he "Did swair Rashly, vainly and profainly in his then Dwelling House in s'd Haddam." The verdict was that "the said p—— is not Gilty In manner and forme as set forth in s'd Deckilation and therefore may be Dismissed *He paying the cost taxed at £1, 2s, 8d.*"

Perhaps the accommodating Captain regretted that he had not sworn rashly and vainly as charged. Perhaps he took an early opportunity to experiment in that line. But of one thing we may be sure his longings to return to old Haddam and end his days there was over.

This was January 10. That same night the Captain, in honor of his temporary sojourn in Haddam—and perhaps, in celebration of his rather doubtful victory in court—got up a little tea party. A fair assumption, as we have it recorded that he attended Court next day and confessed a judgment against himself for the "sin of Intemperance." Having thus behaved in a fairly generous way toward the town treasury the Captain with a clear conscience retired to his country seat in Waterbury, and the presumption is that very little Haddam dust was found clinging to his feet when he took his departure.

And so the record runs. But it was not all fining and granting executions—there was an occasional brighter side. Witness the following records copied verbatim:

"April the 28 1774 then William Michel of Middletown was married to Jerusha townner of Haddam

By me

J. B. Justice of peace."

"November the 10 1774 then Elijah atwood was married to his wife Mary

By me J. B."

"March 23, 1777 then Ebenzer Wyllys was married to his wife Jemima

By me J. B."

In turning to Squire Dart's records (beginning in 1780) we find that a large volume of business was done—of considerable variety too—but the bulk of it had to do with book accounts and overdue notes. Occasionally, however, a matter presents itself that has its special points of interest. For example, I have been much interested in noting the vigor and efficiency with which the law of the colony was evoked to meet the needs of the "transient person."

Two such gentlemen, Smer and Tedeo by name, had some midnight dealings with one Ebenezer Rowley in 1783. Ebenezer, it appears, was not well pleased with some of the attendant circumstances of the affair. Next morning he caused a writing to be made—commonly known as a writ—in which Messrs. Smer and Tedeo were charged "with taking from s'd Rowley on the Night after the 21st of Inst July 4 Good linnen shifts two Good linnen shirts upwards of 10 yards of Good tow cloth a linnen Gown 2 table cloths 2 lawn aprons and sundry other articles all to the Damage of the plantif Two Pounds Lawful money."

The sentence was that each be "whipt on the Naked body with a suitable whip at sum post Five Lashes and be further punished by

Court Record of Jabez Brainerd, 1773-1775

paying a fine of 3s L m for the use of s'd Town and pay s'd Rowley 2£:05:0d lawful money Damages and the cost of prosecution taxed at 2:3:1 and stand comited till s'd Judgment is answrd."

"Comited" they both were; but later Ebenezer, standing in need of an extra hand or two, and perceiving that there was a surer way of securing his own share of the proceeds, decides to take the two faithful friends and co-laborers into his service—for a period of time of generous dimensions.

Yet we ought not to think that Justice Dart showed partiality in the bestowal of his favors upon transient persons. For in 1785 two residents of the town, Lemuel R—and Sarah E—were jointly involved in a small adventurous affair with "two swine." Selah Jackson, the owner of the swine, said right out that it was a plain case of stealing. The court adopted Selah's view of the affair, and the antidote was that, after the usual several shillings benefit to the town treasury had been provided for, Lemuel should be "tied to a tre or post and whipt with a suitable whip on the Naked Body 8 Lashes," and Sarah ditto—"5 Lashes."

I suspect from other records that in the case of Lemuel and Sarah Squire Dart had good reasons for adopting heroic measures. His prescription is comparatively mild in a case occurring five days later. Captain Israel Higgins, having missed "3 steel Horse Shoes," undertook to show that he was damaged to the amount of 18 shillings. The Captain won his "sute," but the damage was placed at only one shilling, and an execution had to be granted to secure that, and there is no mention of a "sutible tre or post."

The writer, having made a number of inquiries regarding the fact and location of a training field in Middle Haddam, was pleased to find mention made of such a field in

Squire Dart's narrative, though not altogether delighted with the circumstances under which that historic spot was referred to. Three of the several items are concerned with happenings at the field on Thursday the 30th day of October, 1783, which appears to have been an eventful day in Middle Haddam military circles. Something went wrong, was misplaced, or carelessly handled, or, at any rate, not sufficiently lubricated. For the next day Oliver A— was handed out two judgments; one for "prophane Cursing and swairing at the Training Field at middle haddam," the other for "striking Corp'l Ithamor Rowley in the traning field in middle haddam." The fine in each case was six shillings and one shilling cost of Entry. A point in Oliver's favor is that he voluntarily came to court and confessed. A point not in Oliver's favor is that the year following the judgment was still unsatisfied and Oliver still warding off the fatal day of payment by giving two notes of seven shillings each.

But the October 30, 1783 returns were not yet all in. For July 19, 1784 we find Nathaniel S— going to Squire Dart's confessional and recalling some things he fain would have forgotten—for example, a small matter of "prophane cursing and swairing at middle haddam Train field" on October 30 of the previous year. Seven shillings is the price for having his memory jogged. Nathaniel meets this unexpected requisition by giving his note for that amount.

Our ancestors were to a considerable degree human, and while we like to think of them as solemnly going through this military business to be ever in readiness to meet their country's enemies—we must not lose sight of the fact that they also most generally had an eye open for an occasional enemy near at hand. For example, Ashbul A—felt a strong call of duty in that direction during, or it may have been just after,

Trials in Early Justice Courts in America

the military maneuvers of the 1785 October training. For at the next session of Squire Dart's Court he cheerfully confessed and actually paid his seven shillings down for the great freedom of speech he had temporarily enjoyed on the last great day at the Middle Haddam training field.

It may be appropriately mentioned here that a large quantity of "State's powder was stored in Chatham in 1783. James R— was in difficulty that same year because some of the powder was missing, and one cask was found by "Insn" (Ensign?) Jedediah Hubbard near James R—'s abode. The case went to the County Court at Hartford under a bond of 100 pounds.

Some notice may also be taken of several attempts to check what was known as illicit trade—that had to do with embargoed goods.

In 1780 "mr. william Bevins" is granted a warrant to "seize a whale boat from Long Island in the Eliset trade."

Nov. 7 of the same year Capt. Joshua Griffith complains of a schooner "Speedwell," Obed Barlo, master, "in Eliset or embargoed trade"—also of a sloop of 20 tons, Amos Wright, master, with "prohibited articles." A few days later Mr. Bevins complains of the sloop "Cumberland" of 30 tons, Thomas Lewis, master, "Laden with embargoed articles to be conveyed out of the county."

A case that greatly interested the writer when he came upon the record was one that came to trial April 4, 1786, in which Zepheniah Michel of Chatham was plaintiff and "Isreal Putnam of Pomphret and county of Windham, Def'd." It was an "action of Book Demanding the sum of £4." We hardly know whether to praise or censure citizen Michel's pushing spirit in this matter.

The General was, if anything rather less enthusiastic than Zepheniah in the matter. When he at

last arrived in town he declared that he "owed nothing." But the "evidences" were as usual resorted to, and the famous wolf hunter and Revolutionary fighter yielded at last to the persuasive "Opinion" pronounced by Squire Dart in his very best style. The sum granted Zepheniah, however, was but £2. The additional charges were:

	£ s d
"Writ and Duty, - - -	- 0: 2: 6
Officers fees, - - -	- 0:12: 1
Plaintiffs travl and tendance, - 0: 2: 4	- 0: 2: 4
Cort fee, - - - -	- 0: 3: 0
	0:19:11 "

Chatham likewise had its own way of treating certain worldly diseases. For example, May 7, 1781, Elijah J— and Stephen G— were admonished that the little game of cards which they had enjoyed at a neighbor's house would cost them 10 shillings each. The bill was paid, but whether the cards were henceforth eschewed we have no means of knowing. However, it is in such items that we catch a glimpse of the stern conception of duty under which our forefathers labored in building the social fabric of their days.

Speaking of the records in general it seems a little strange that where the "Cort fee" was only a shilling, or seldom more than two, and the other charges relatively small, not infrequently a note would be given for the total amount. The words "paid for" or "Judgment satisfied" are, if anything, of rather rare occurrence. After one trial was over Justice Dart added to the record the words "Nothing paid," as though he were a little bit discouraged with that sort of court business. Most commonly he writes, "Execution granted," and a few months later adds, "An alias execution granted," and then perhaps the following year, "Execution removed." Sometimes the account is thus carried forward over a period of several years, and at the last "no cash" in sight.



The Home of My Childhood

BY ANNA J. GRANNISS, AUTHOR OF "THE BOY WITH THE HOE"

I've been a long journey and back today—
'Twas rise and set of a single sun,
I have traveled two score of years away,
And have returned with the journey done.

To the sun-lit vale of my early youth
I bent my steps in the dewy morn,
And by noon I came to the place in truth,
And entered the house where I was born.

As I stood in the long deserted hall,
A throng of memories met me there;
They gazed at me from the vacant wall,
They called to me from the creaking stair.

They knelt with me at the cold hearth-side
Where the gay flames danced in other days;
They mingled their voices with mine and cried,
Holding pale hands to the vanished blaze.

In the open chamber which once was mine,
The sun still shone on the same old beams,
But, oh heart of mine, how it used to shine,
On the splendid castles of our dreams!

My glimpse of the world through a window given,
Was rainbow-hued in that far-off time,
Then my own "Blue Hills" reached up to Heaven,
And I was eager and longed to climb.

Oh, what have I been that I hoped to be?
What have I done that I thought to do?
Return, oh ye days of my youth to me,
Those early pledges I would make true!

From the crimson dawn to the sweet day's close,
Still, God through Nature is calling me,
As all through the ages He calls to those
Who have ears to hear, and eyes to see.

And when my spirit, as one who sings,
Trills in response, I believe and know
That a breath Divine is upon the strings
By Nature fashioned to vibrate so.

And believing this, shall I cry "alack!"
For the unsung melodies of youth?
Shall I bid the years of my toil turn back
The years so rich in their love and truth?

Even though the Fountain of Song be sealed,
Though I grope my upward way blind-fold,
Already to me there have been revealed
Things such as poets have sung and told.

No—the voices heard as a little child
Nor toil, nor the world's rude tones have stilled;
Life's conflicting claims will be reconciled,
Its highest purpose will be fulfilled.

The Man of the Southwest



HERE hang the old long-rifle and the axe,
Shadowy, yet huge and grand,
I see the hairy hand
Once clutched them, never to relax;

But to defend the home already won,
And strike yet, blow on blow,—
Feed to the wolves the foe,
And hew on toward the setting sun.

He of that daring, hunter's hand scorned rest;
He must—'twas destiny—
Push onward, do and die,
Blazing the race-trail West and West.

Nature did him for hero's hazardry
From out her wild womb fetch:
Yon hand would westward stretch
The Alleghanies to the sea.

A form grows to the hand. I see him tread
The solemn forest-way,
While butcher-bird and jay
Flit round him in the silence dread.

Idle the warnings in the low wind's talk;
Lord of the woodland dim,
Little they trouble him,
Storm, famine and the tomahawk.

The panther's thews he has, the lynx's eye,
The carriage of the tree;
Stern opportunity
He challenges—it goes not by.

By John Hance Cheney

No tame, unvaried toil would he begin
Who makes of skins his dress,
His home the wilderness
Europe could lose her kingdoms in.

He knows the tumult of ambitious might
That will the pillars shake;
Will States unmake and make,
Wipe out old landmarks, and rewrite.

To his rib-mould the powder-horn is curled;
With gladiator's mien
He moves from scene to scene,
Mapping the marches of a world.

Ay, thou grim shade, I see and understand:
That haft and stock were held
That Freedom's sons might weld
The alien oceans sand to sand;

File out along the fateful trail, to bring
Men wider liberty;
Yea, lead it sea to sea,
So far it tires the wild bird's wing.

Grim, nameless shade, he does not need a name
Who leaves thy rich bequest.
Cemented East to West,
We, Freedom's men, we are thy fame.

He heard. He fades as when the brown leaf-fall
Laid peace upon his sleep;
Only the rude tools keep
Their vigil on the dim-lit wall.

Travel in America

BY DR. ROLAND D. GRANT

AFTER forty trips across this continent, and twenty years singing the praise of hill and dale, of cliff and crag, of lake and river, I am still looking forward to new revelations of the glories of America. The beauty, charm and wonder of its scenic wealth is beyond calculation. It seems to hold in counterpart all the riches of the world.

If you want Southern France, or Southern Italy, with their fruits and flowers and palms and bowers, with groves of oranges and pomegranates and bananas, or a hundred acres of snow-white lilies, or a half mile of trellis of geraniums and rose-bushes, they are here in endless profusion. The Yellowstone Park now stands forever alone the wonder piece where God is still at work finishing the crust of the earth. Between the Yosemite and Kings River Valley of the South and the mighty Yoho valley of the North, are upturned vaults and glaciers to astonish the world, a single one of which is more vast than all the glaciers of Europe combined. While in waterfalls of every possible size and height and combination, so many that it is really a confusion to remember their names, there are places where mighty cliffs fling a dozen of gem cataracts from some precipitous height, all to be seen at a single glance. The Colorado Canyon, with its mile of depth and dozen miles from shore to shore, would swallow the gold of the nations, and makes all similar scenery of the Old World diminutive in the extreme.

Lake Logano and Como are perhaps the most refined gems of European scenery, but we have lakes almost without number possessing equal charm, although it belongs to a group of a hundred similar lakes of indescribable beauty. The Rhine is more than matched by our Columbia

and Snake rivers, and the history of the Columbia can match the Rhine in delightful story. Giant's Causeway and Fingal's Cave are matched a hundred times in Idaho.

When asked if America had a Mount Vesuvius the reply was made, "Not exactly, but we have a Niagara that could put it out if it should ever get on fire." I said to a man at the base of Vesuvius, "No, our volcano is not just like this, but we have an extinct crater in America so vast that you could pull Vesuvius up by the roots and drop it into our crater and Vesuvius would go a thousand feet out of sight."

This continent is a museum world, and I hereby give to you the keys to its myriad canyon corridors, cathedral towers, and crypts of ancient history. You and I have enjoyed these things for years and must consider them as only ours in trust, for the true patriotism is a fatherism that prepares the trail for those who shall come after us.

I want American scenery taught in the public schools. I want you to save and protect the Indians. I want to save the animal life, the buffalo, elk, deer and beaver. These are the original inhabitants. They have a claim upon your honor. Oh, to see once more a million pigeons as I saw them in Minnesota in 1867, or five thousand geese arise from a Minnesota lake!

Underneath the American deserts are rivers of living water waiting to come to the surface to transform all the regions into gardens of bloom. This is the land flowing with milk and honey, grass for the cows and flowers for the bees. This is the land of promise, "the land whither ye go to possess it is a land of hills and valleys and drinketh the rain of the water of heaven."

Excerpt from address before the "See America League" in Salt Lake City, Utah.

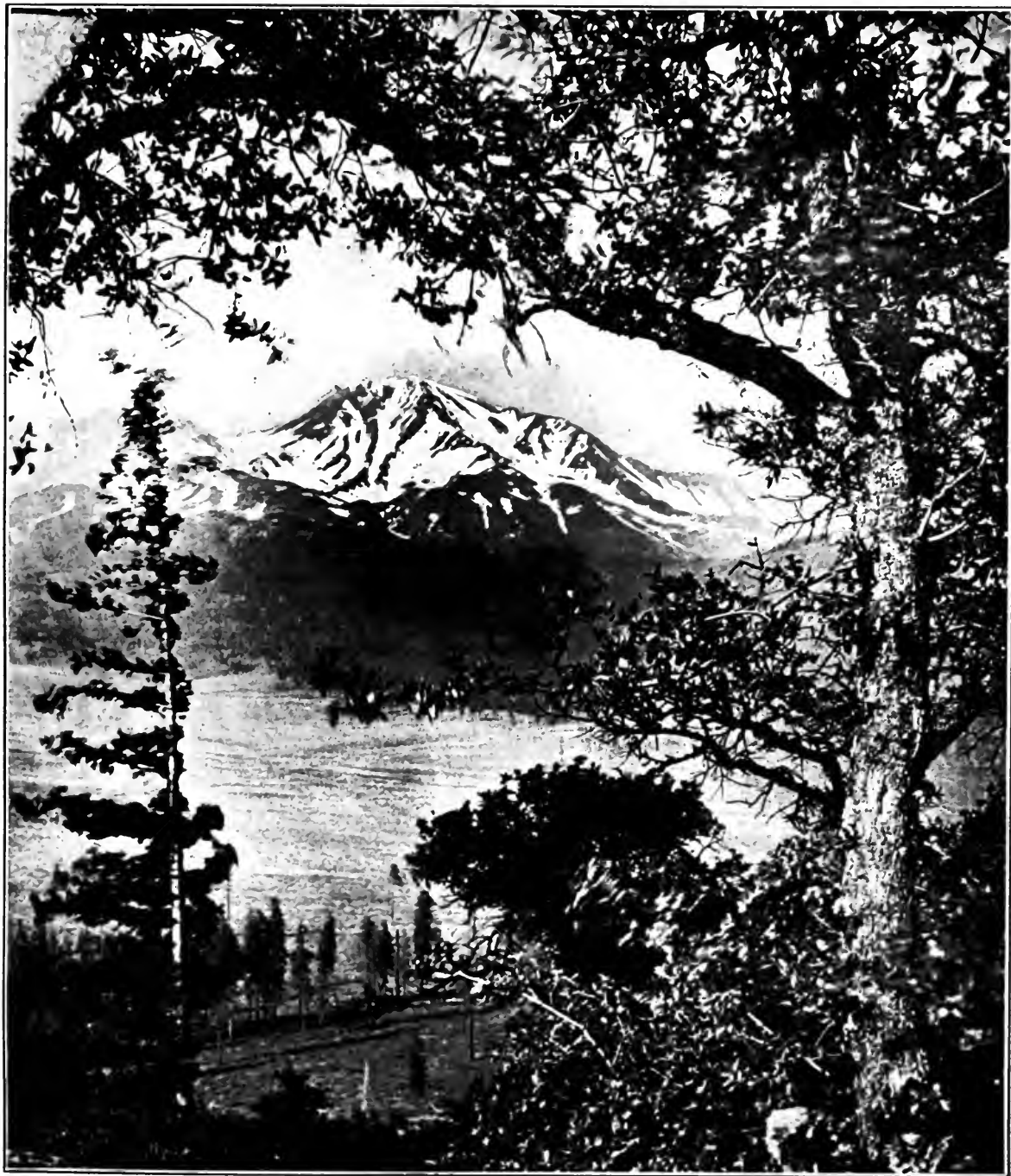

THE MAJESTY OF NATURE'S MASTERPIECES

Thro' summer-clad boughs
to grand snow-capped Mount Shasta, in
California, 14,442 feet high — Sun Sculpture
by Underwood and Underwood, New York — Copyrighted

**Travel
in America**

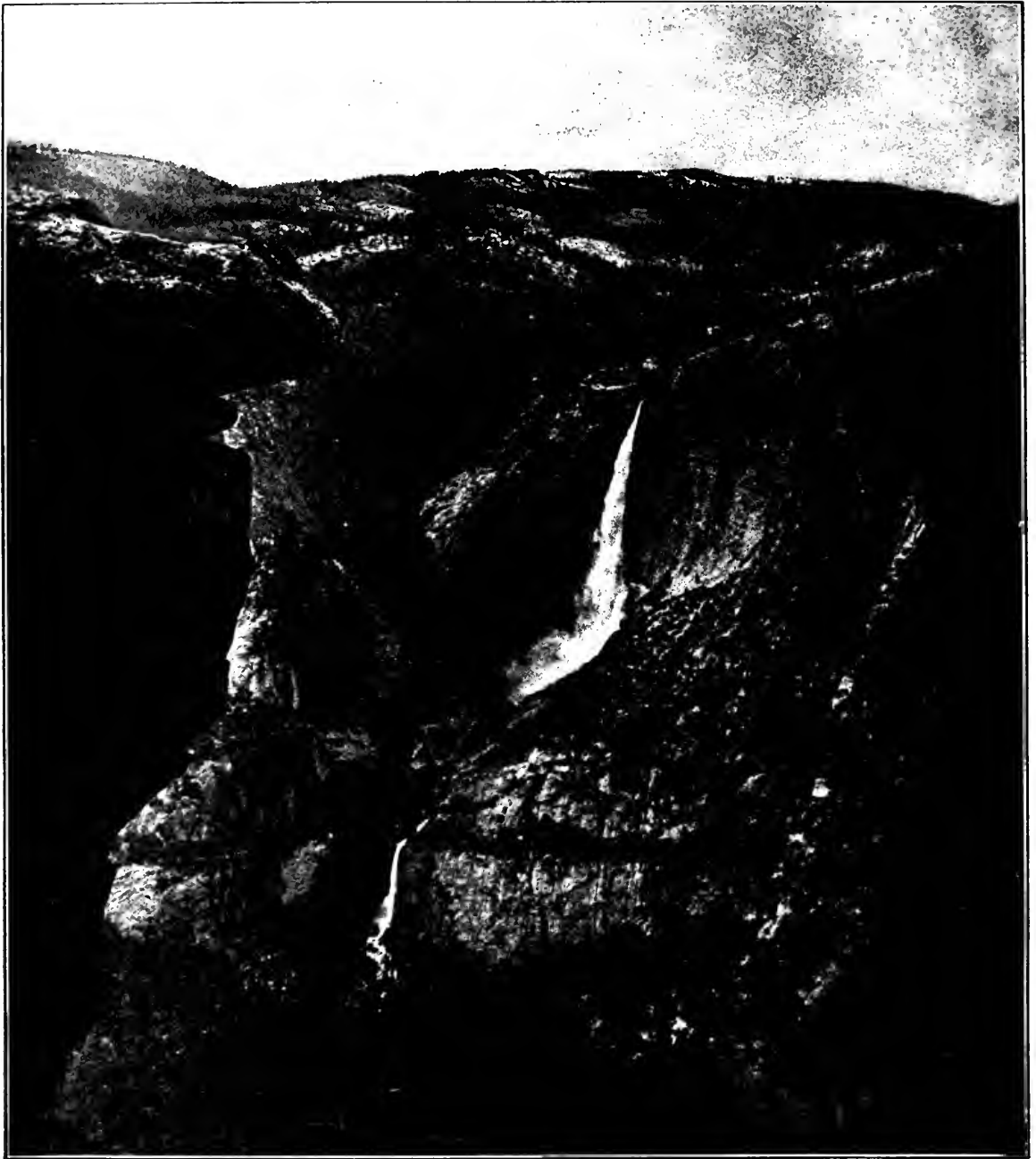

THE WONDERS OF GOD'S HANDIWORK

Nearly a mile straight down
from Glacier Point in the Yosemite
Valley in California — Sun Sculpture by
Underwood and Underwood, New York — Copyrighted

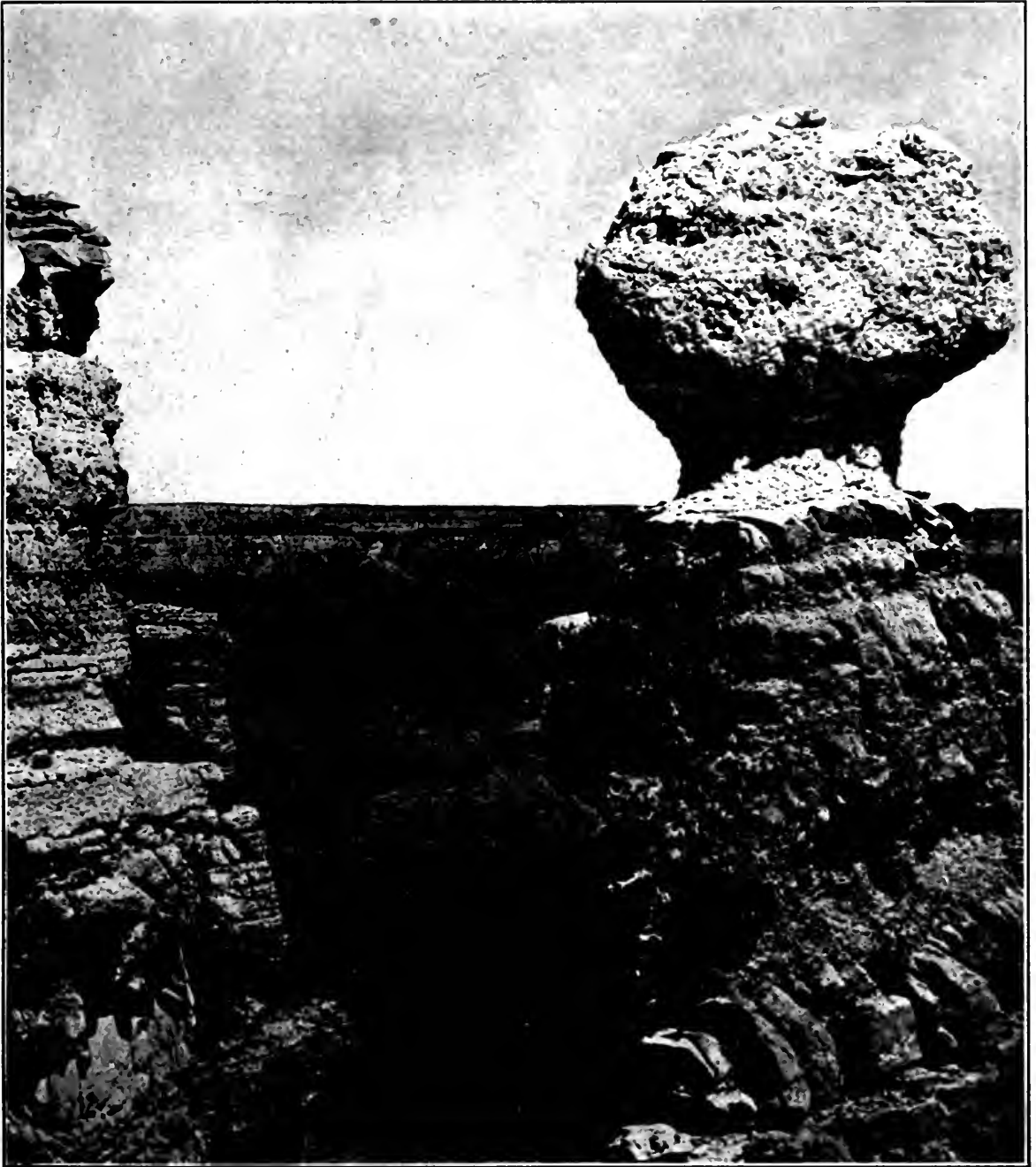

THE MASTER'S MARVELOUS ARCHITECTURE

Survivor of the Primeval
Flood in the Grand Canyon of
Arizona—Sun Sculpture by Underwood
and Underwood, New York—Copyrighted

**Travel
in America**

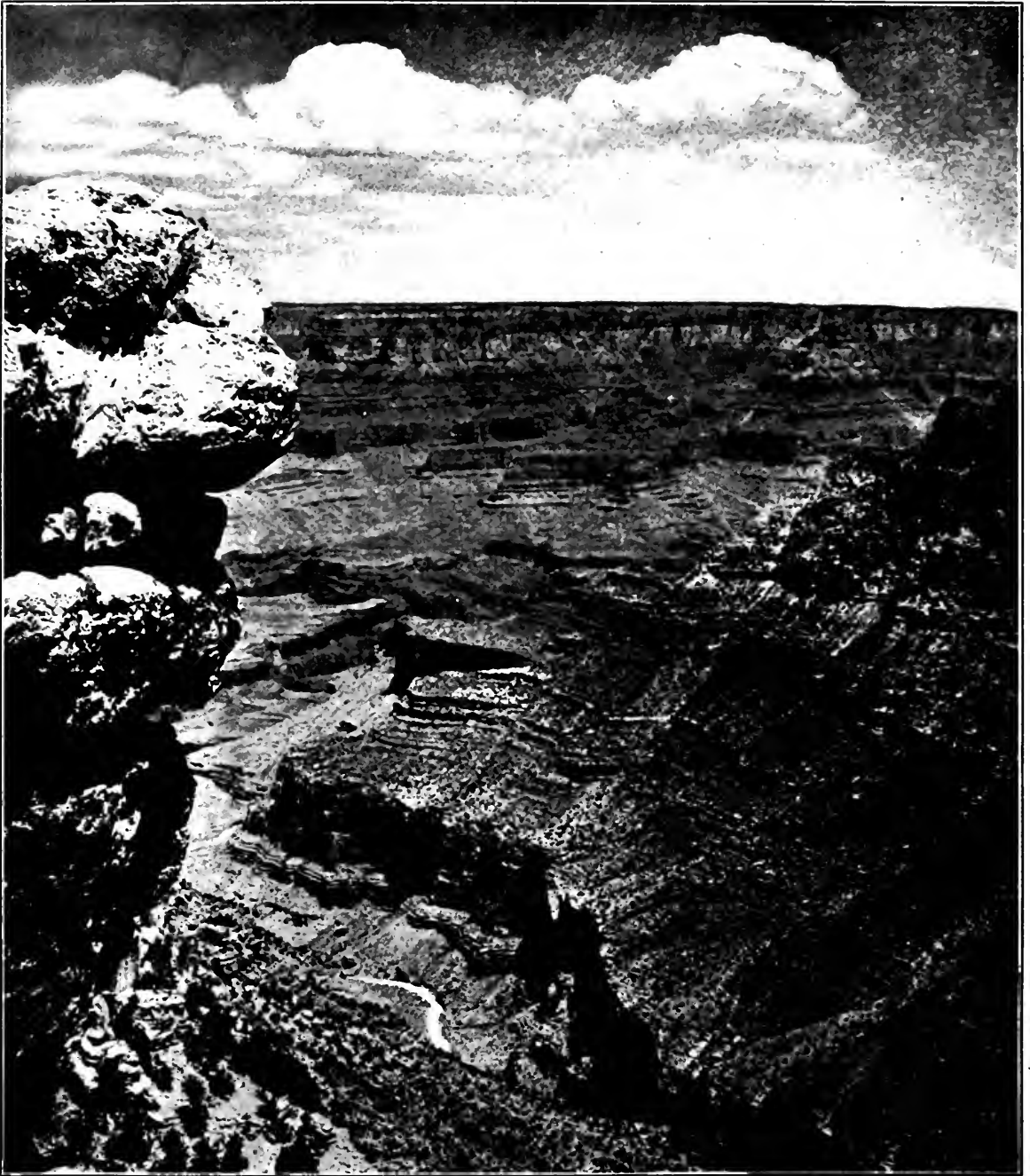

NATURE'S GREATEST AMPHITHEATER

Fathoming the depths of a
vanished sea — that in ages past
swept thro' the Grand Canyon of Arizona —
Sun Sculpture by Underwood and Underwood, New York — Copyrighted

ODE TO AMERICA

Earth's Land of Liberty

BY

DONALD LINES JACOBUS

I

O Land amid the seas!
In whose green sun-kissed fields fair blossoms
blow;

Bright jewel wrapped in snow,
Yet breathed upon by balmy southern
breeze—

O Land of cities proud,
Whose thoroughfares pulsate with throbbing
life,

Whose massive walls with strife
Reverberate and, weary, cry for rest aloud:

II

O Land of silent mead,
Of peaceful plain, green hill and bounteous
farm,

Where safe from wild alarm
The earth gives up to every man his need!

O country of our love!
Thine both the drear monotony of toil
And thine the tempest's moil
When furies loose their angered voices far
above.

III

Fair Land whose climature
Is varied as thine own e'er changing face,
Which here from lowly base
Rises aloft to snowy summits pure,
And stretches level there
In rolling plains graced not by stately tree—
Our native Land, to thee
This hymn of praise we chant, extolling thee
in prayer.

IV

Earth's Land of Liberty,
Where King's dominion e'er will be unknown,
And tyrant rule o'erthrown
That all may live a life of manhood free:
May we forever boast
A fame unsullied and an honored name,
No stain or blot of shame
In all the land from hill to hill, from coast to
coast.

V

What other land but thee
In freedom's cause a patriot's battle waged,
Her sacred honor gaged
That in her borders none enslaved should be?
What country else resigned
Her sons to death, a sunny isle to save
Washed by the tropic wave,
And guards two continents, by oceans four
confined?

VI

O loveliest land of all
To which the sun's wide circuit bringeth
light,
By thy maternal right
Our love and reverence holdest thou in thrall.
All hail, America!
The land of freedom, progress, thought and
worth!
The children of the earth
And stars of heaven sing: All hail, America!

VII

Lord God of glorious might,
Whose universal mercy we adore,
All-Father we implore
Thy aid by day, thy watchful care by night.
Guard our beloved land
From foes without and dissidence within;
Shield us from pride and sin,
And rule America, O God, with loving hand.

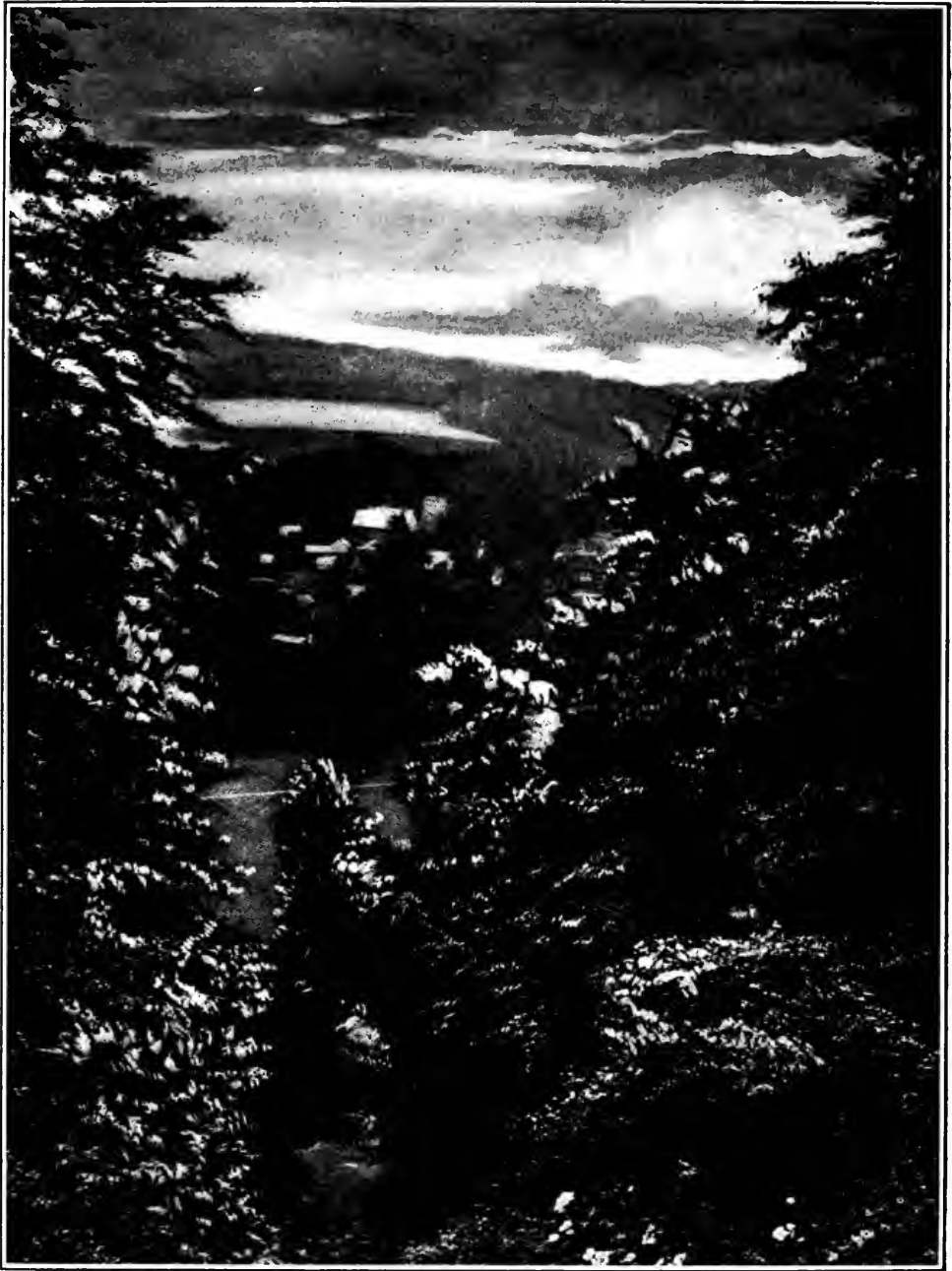

"Fair land whose climature
Is varied as thine own e'er-changing face"

"Such matchless splendor canvas ne'er has shown,
Nor Art nor tongue the beauteous blush portray"



When Daylight Dies ❀ An Evening Pastoral By John H. Guernsey

'TIS Eventide; the King of Day descends,
To mark the course where weary labor ends;
Across the sky his crimson beams are thrown,
Such matchless splendor canvas ne'er has shown,
Nor Art, nor tongue the beauteous blush portray,

That gilds the heavenly dome at close of day.
'Tis Nature's hour to fill the land with peace,
As, wrapt in slumber, countless sorrows cease;
Blest Comforter, while hearts forget the pain,
Renewed in strength to take it up again.
See the white mist from yonder meadow rise,
O'er which the myriad lamp-lit insect hies.
The twilight deepens with an incense sweet,
As children's good-night songs at mother's feet,
And ling'ring shadows gently reunite,

'Till Daylight softly clasps the hand of Night.
Serene the lake that lies along the grove,
Whose mirrored depths repeat the sky above,
A wondrous starry banner heaven unfurls,
That answering orbs may greet the parent worlds!
Beneath the surface hide the latent rings,
'Till wakened by the swallow's truant wings,
The circles hasten with a sweet unrest,
To lave the sleeping lilies on its breast!
Beneath the wooded arch the mountain stream
Reflects sweet Luna's primal length'ning beam,
To joys anew the silver floor invites,
And many a laughing, dancing, fairy sprite
Comes tripping from the shadow of the mill,
To amorous vespers of a whip-poor-will,
Whose triple love notes from the woodman's street,
Win many an echoed bride in cadence sweet!



BESIDE the hedge a modest
bank of flowers
Is gath'ring pearls along the
waiting hours;
The nestled jewels many a
chalice fill

With charms their loving cups alone
distill.

Glist'ning with gems the day will bid forget,
The Lily of the Vale and Violet
Await with open lips the King's delight,
To kiss away the moistened breath of
Night!

* * * * *

And thus the curtains of the Night are
hung:

The curtains part; the morning stars have
sung!

The Academy of American Immortals

THE American people on May the thirtieth will dedicate eleven bronze tablets to the eleven Great Americans whose deeds and memories have recently been crowned by an election to the American Academy of Immortals—the Hall of Fame.

It was a distinguished Western jurist, Judge J. H. Richards of Boise, Idaho, who in speaking of America's greatness, was recently asked: "What is it that makes America great? Is it her mountains, her gold and her silver?"

To which he replied emphatically: "No! It is her men and her women! They are the true and lasting greatness of the country that crown it with everlasting glory. One great man that comes up from the valleys and plains is of more lasting worth to this nation than all the gold and all the silver hidden in the great mountains.

"Men will never be made great by gold alone. It contracts them. They must be taught that money is to expand their hearts and not sear them, by making them understand that the mighty power placed in their hands is to bless God's children throughout their entire country and through them the entire world.

"When we think of how this civilization was planted upon the rocks of the Atlantic coast, narrow perhaps, indeed, were their concepts of what this country was yet to be. But the Being who gave us this

country intended that we should be a great and generous people. He gave us land enough for the plow, water enough for our shipping, iron enough for the forge, mountains enough for grandeur, gold and silver enough for cupidity, snow enough for courage, and sunshine enough for song.

"And when men are whirled from that rocky coast out into the great, broad valley of the Mississippi, their ideas expand. When they see that great valley and its possibilities, the granary of the world, and as they

come on West and see the great plains of the Middle West, and on to these great cathedrals of nature in these mountains, their hearts expand. With expansion they get a grander concept of what an American was intended to and will yet be."

When one considers the great works of the forty immortals now in the Hall of Fame, and that most of them lived and labored on the Atlantic coast long before the Western America had be-

come an element in the moulding of American character, it seems as if the day of American achievement is yet to come and the Great American of the future must be a man the like of whom the world has never before seen. In the last generation men have been making the Great West, but in the next generation the Great West will make Great Men.

In these pages is presented a series of four of the Great Men who have been immortalized by their fellowmen for services of scholarship.

THE HALL OF FAME

FOR GREAT AMERICANS

BY WEALTH OF THOUGHT

OR ELSE BY MIGHTY DEED

THEY SERVED MANKIND

IN NOBLE CHARACTER

IN WORLD-WIDE GOOD

THEY LIVE FOREVERMORE



AN AMERICAN IMMORTAL
RALPH WALDO EMERSON
PHILOSOPHER
BORN AT BOSTON, MASSACHUSETTS, MAY 25, 1803
DIED AT CONCORD, MASSACHUSETTS, APRIL 27, 1882



AN AMERICAN IMMORTAL
NATHANIEL HAWTHORNE
NOVELIST
BORN AT SALEM, MASSACHUSETTS, JULY 4, 1804
DIED AT PLYMOUTH, NEW HAMPSHIRE, MAY 19, 1864



AN AMERICAN IMMORTAL
WASHINGTON IRVING
HUMORIST
BORN AT NEW YORK CITY, APRIL 3, 1783
DIED AT IRVINGTON, NEW YORK, NOVEMBER 28, 1859



AN AMERICAN IMMORTAL
SAMUEL F. B. MORSE
INVENTOR
BORN AT CHARLESTOWN, MASSACHUSETTS, APRIL 27, 1791
DIED AT NEW YORK, APRIL 2, 1872

503.

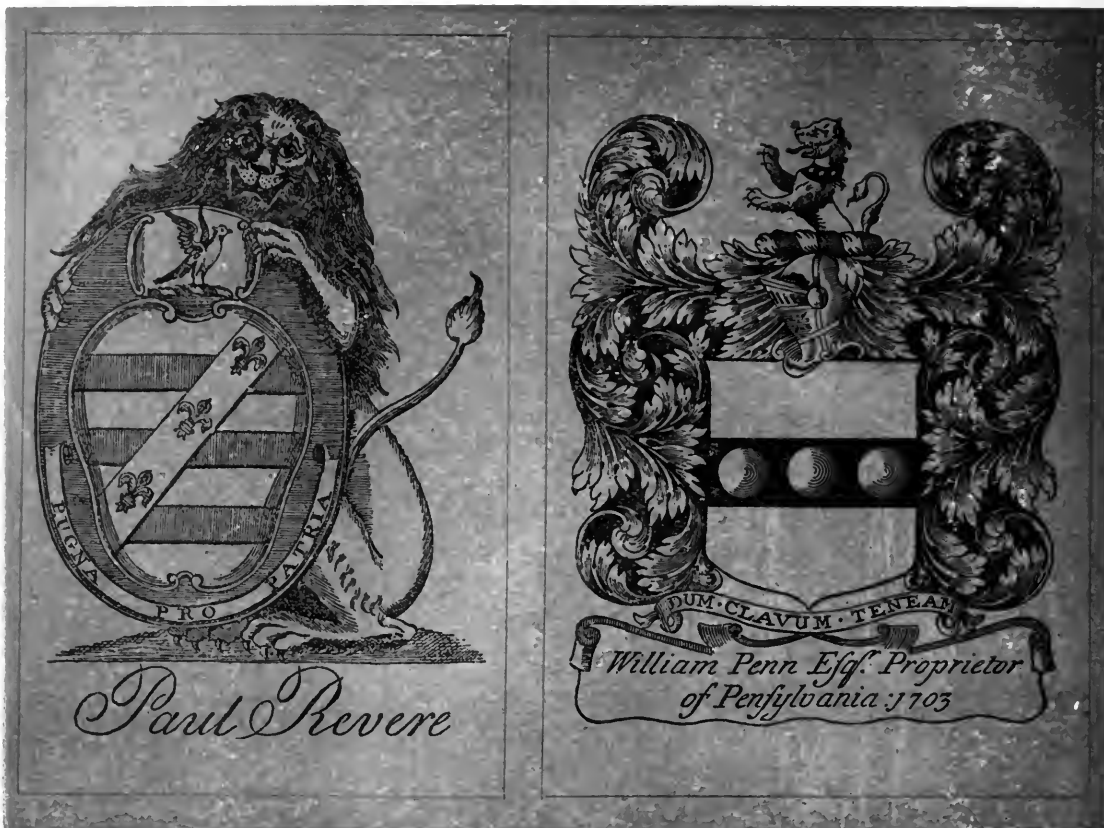

Ex Libris Modern Adaptation of the Old Art of Book Heraldry that originated within half a century of the invention of printing

IT was within a half century from the invention of printing that book-plates were introduced as identifying marks to indicate the ownership of the volume. Germany, the fatherland of printing from movable type and of wood-cutting for making impressions in ink on paper, is likewise the home-land of the book-plate. The earliest dated wood-cut of accepted authenticity is the well-known "St. Christopher of 1423," which was discovered in the Carthusian monastery of Buxheim in Suabia.

It was to insure the right of ownership in a book that the owner had it marked with the coat-of-arms of the

family or some other heraldic device. Libraries were kept intact and passed from generation to generation, bearing the emblem of the family. The first book-plate in France is dated 1574; in Sweden, 1575; Switzerland, 1607, and Italy, 1623. The earliest English book-plate is found in a folio volume once the property of Cardinal Wolsey and afterward belonging to his royal master. The earliest mention of the book-plate in English literature is by Pepys, July 16, 1688. The first-known book-plate in America belonged to Governor Dudley. Paul Revere, the patriot, was one of the first American engravers of book-plates, and a designer of great ability.

Voyages of an Old Sea Captain

Adventures in
South America and in
the Ports of the Old World during
First Years of the American Republic & An
American Citizen Impressed into the British Service &
His Daring Escape after Years of Captivity and Conflict & Autobiography

BY

CAPTAIN JEREMIAH HOLMES

COMMANDER OF THE "HERO," AND IDENTIFIED WITH THE EARLY MERCHANT MARINE—BORN IN 1782 AND DIED
AT THE AGE OF NINETY YEARS

'Tis the bold race
Laughing at toil, and gay in danger's face,
Who quit with joy, when fame and glory
lead,
Their richest pasture and their greenest
mead,
The perils of the stormy deep to dare,
And jocund own their dearest pleasures
there.
One common zeal the manly race inspires,

One common cause each ardent bosom
fires,
From the bold youth whose agile limbs
ascend
The giddy mast when angry winds con-
tend,
And while the yard dips low its pointed
arm,
Clings to the cord, and sings amidst the
storm.
—HENRY JAMES PYE'S "NAUCRATIA," 1798.

“**G**O to sea, young man!” This was the advice of the first fathers of America to the sons of the Nation a few generations ago. It was considered “the manly thing to do.” Old England had long been the lord of the seas, and the new Americans were “a race of men inheriting her seafaring aptitude, and destined to dispute her maritime supremacy.” Thousands of young Americans sailed “before the mast on board the swift London packets or in the carrying trade to the West Indies, and twelve thousand American seamen enlisted in the King’s ships and the Colonial privateers during the Seven Years’ War with France.”

This absorbing story of life on the high seas shortly after the founding of the American Republic is faithfully given as received from the lips of the venerable sea-captain by his nephew,

the Reverend F. Denison. In recording the old mariner’s reminiscences, Reverend Denison said: “Having, in common with many others, a laudable anxiety to secure a full narrative, in a permanent form, of the life of my uncle and his varied fortunes by sea and by land, in peace and in war, I persuaded him to sit down at different times and relate to me the prominent events of his history.”

Captain Holmes, whose life story is here related, was the son of Jeremiah and Mary (Denison) Holmes and was born September 6, 1782, near the village of Milltown, in Stonington, Connecticut. At fourteen years of age, in 1796, he went to live with his brother-in-law, Thomas Crary, in the town of Norwich, Chenango County, New York. He remained here four years and then “took to the sea.”

Captain Holmes died in Mystic, Connecticut, at the age of ninety years. The following transcript from his original autobiography is contributed by Mrs. H. B. Noyes of Mystic.

Autobiography of Jeremiah Holmes—Born 1782

NOT every one can feel at rest upon a farm. Our callings are as various as our tastes and gifts. Being of a restless temper I was allured by the prospects of the sea.

Leaving my brother-in-law at Norwich, Chenango County, New York, in January, 1800, I traveled on foot one hundred and ten miles to Catskill on the Hudson, from whence by packet I reached the city of New York. Eager for an opportunity to know the ocean and foreign lands I shipped in the schooner "Four Sisters," under Captain Peleg Barker, destined, as our papers read, for the Falkland Islands. The state of commercial affairs prompted to the artifice.

We instantly sailed for Rio de Janeiro. Reaching that port the captain opened an unrecognized business and in fact smuggled on shore dry goods to the value of forty thousand dollars. After about two months our lucrative business became suspected when the authorities commanded us to leave the port. Anxious to remain, the captain feigned himself in ill-health; but the ruse was unavailing. Thus driven from this port the captain concluded to sail northward. We finally ran into the mouth of the Amazon and anchored near the mouth of Para River, yet so broad were the waters at this point that but for the freshness of the water we might have concluded that we were on the shore of the ocean. Attracted by the few dwellings in sight Captain Barker sent a boat on shore containing the mate and four men. The boat and its crew were unexpectedly detained. The Portuguese government in Brazil did not at this time tolerate commerce with foreigners. With the morning our boat and men returned, but they were accompanied by another boat bearing a white flag and filled with soldiers. Our visitors were reluctantly entertained.

Aboard Ship off Brazil and Confined in a Dungeon

The moment the soldiers came on board they took forcible possession of the vessel, when they carried the captain, mate and supercargo on shore and then, binding the remainder of us, proceeded with the vessel up the river. Thus we became prisoners and our vessel the prey of the Portuguese power in Brazil.

Para stands about sixty miles from the river of the same name. The city is guarded by a strong fort. In the center of the fort is a huge, dark dungeon, a subterranean prison so dark that objects are dimly discerned at mid-day though near the eyes. We were hurried into this fort and thrust into this dungeon, a very undesirable harbor for one who delighted in the free air and paths of the ocean. It was now June; we had been five months from home; our prospects were gloomy indeed. We were under the equator, and the heat of the country was nearly intolerable. The old dungeon in the center of the massive fort knew no healthy light and no refreshing winds. There were eight of us to share this close, dark, sweltering subterranean prison. To add to our discomforts we had been robbed of all our clothes except what was found upon our persons. Thus destitute and suffering we were held in this detestable dungeon for a period of nearly two months.

The walls of the dungeon were of stone; the doors were of wood and only some three or four inches thick. Our only hope looked through these doors; and but a little light from these entered the eye of hope; yet a little light did for a time reach our anxious hearts. One of our company had the fortune on his capture to retain in his dress an old but substantial pocket-knife. After counting for days our feeble hopes of escape from our dire imprisonment, we concluded to center our hopes upon the edge and strength of the old knife—a precious

Voyages of an Old American Sea Captain

instrument now in all our eyes. Selecting a side door to our dark abode, we cut carefully and at guarded hours channels or grooves around a panel-shaped piece large enough to admit a man's body. The grooves were finally cut through, and all our hopes were on tip-toe in silence and in watchings. But unfortunately, by some heavy jar, the separated panel-piece slipped our temporary fastenings and fell back upon the dungeon floor with a loud noise that alarmed our keepers and revealed our plot. But had this mischance not occurred our hope of escape would have been exceedingly small since the dungeon was in the center of a strong and guarded fortification.

Held Prisoner by Portuguese Four Months on a Frigate

The authorities now took us to the river and put us on board a frigate lying near by the place and where we were much more uncomfortable than in the gloomy old dungeon. We were thrust into the frigate's hold where the confined air was well nigh as hot as in an oven. Yet on the following day we were allowed our choice to remain in the hold or to come on deck and work. We were unwilling to toil as slaves under taskmasters beneath a broiling sun. Albeit our bodies might have been more comfortable in the breezes on the frigate's deck and drenched with perspiration, our spirits were yet too proud. We endured the roasting heat of the hold for about a week when, fearing the worst for our health, we consented to work on deck. We were thus painfully imprisoned on board this frigate for nearly four months—and long months they were as one may imagine.

A couple of Portuguese vessels were now about to sail for Lisbon. As one of the lieutenants of the frigate, John George, a Portuguese, could speak good English, we prevailed on him to act as our petitioner to the governor of the place to send us to

Lisbon. Our petition was successful. The governor sent us the following reply: "I do not wish to be troubled with you longer; I shall send you out of the river by the first opportunity."

Shortly seven of us were sent on board the "Grand Maranham," a large ship carrying twenty-two guns and having on board, with crew and soldiers, about one hundred men, all Portuguese. We sailed from the mouth of the Amazon in November. The ship being a dull sailer and suffering now with calms and now with adverse winds, we had a very hard passage that occupied about one hundred and thirty days whereas an ordinary passage numbered about fifty days. On account of the length of the voyage we suffered severely both for water and provisions. For forty days I had but a pint of water per day and a little farina meal made of the cassada root found in South America. Indeed I had no meat or bread during the whole voyage.

Setting Sail for Portugal with a Superstitious Crew

On account of the adversities and privations of our passage the superstitious Portuguese, being devoted but ignorant Catholics, imbibed the idea that the misfortunes of the voyage were ascribable to the presence of heretics or Protestants as some of us were. Upon this matters came well-nigh assuming a serious form. They vowed if we had not a favorable wind by a given day they would cast all the heretics after the ill-fated Jonah. They were in earnest in their vow and threat. We therefore made preparations for such an event by securing and concealing slung shot and other means of defense and offense, resolved to give the Catholic faith a little of the ring of Peter's sword and make the triumph of that faith as difficult as possible. But propitious winds prevented an encounter.

Our voyage had various discomforts. All on board suffered from the filth and vermin abounding in the

Autobiography of Jeremiah Holmes—Born 1782

old ship. In most cases there was neither ability nor disposition to avoid the contamination. My single and scanty suit worn in the smothering dungeon and on board the old frigate during the long and laborious months of my imprisonment had fairly earned a discharge; so on the voyage I was presented with a little refuse canvas and duck out of which I made, after no Parisian pattern, a duck shirt, duck pantaloons and a canvas cap—one suit only and pressed by my bones night and day. My compact wardrobe soon had other claimants whose demands became unpleasant. I have pulled off my duck shirt, picked off a score or more of lusty, healthy, hungry vermin, and again donned the apparel as if new. Thus we had more companions and faster friendships than we were pleased with.

Nearing the coast of Portugal we fell in with an American vessel from which we obtained a supply of water. Words cannot describe the relief. It was a luxury past description to once more press to our lips as much water as we desired to drink; and we did drink copiously and thankfully. The happiness of that hour cannot be forgotten.

Our circumstances made it expedient to land at St. Ubes. We reached the port in March, and it was yet cold on the coast. The American consul at once sent us to Lisbon, which was eighteen miles distant; but we were obliged to go on foot. I had no shoes and no coat; but I still had more or less of the volunteer body guard from the old ship with their biting friendships.

I remember somewhat of the aspect of the country as I trudged barefoot and coatless from St. Ubes to Lisbon. The orange trees had dropped their foliage and yet were full of fruit, thus presenting quite a striking appearance. I bought of an old lady an apron-full or near a peck of excellent oranges for a piece worth about two cents. The grape vines had not yet started. It was now the spring of

1801. I had been from home more than a year and had shared more fortunes than I had counted for on my chart of departure.

Homeward Bound with Colonel David Humphreys from Spain

In Lisbon I found the ship "Perseverance" of New York, belonging to Isaac Wright, Esquire, the well-known proprietor of a line of ships running to Liverpool, called the Black Ball Line.

The "Perseverance" was commanded by Captain Caleb Cogswell, a worthy Quaker, who exemplified his friendly faith by offering me my passage to the United States. I was happy in accepting his generous offer. Among Captain Cogswell's crew were English, Irish, Americans and one Dane. My destitute condition was only too apparent to all in my dress; yet no one of the crew, except the Dane, named Hanse, showed me substantial sympathy by offering me even the loan of a coat. On learning my fortunes, Hanse at once pointed to his chest and said: "There is my chest and clothes; you are just as welcome as myself." I shall never forget Hanse. Pulling off my duck shirt and pants, my right to which had been so long and vigorously disputed by the vermin, and throwing them overboard, I drew upon the open chest of friend Hanse. Finally the captain and mate added to my wardrobe by a gift of some of their old clothes that I received not unthankfully.

Among the passengers on board the "Perseverance" was the American minister to Spain, Colonel David Humphreys, who, with his wife, was now returning to this country. The colonel had on board a hundred merino sheep that he was transporting to the United States; by the way, I think they were the first sheep of this kind introduced into our country. Finding that I was reared on a farm, the colonel engaged me to take care of the sheep on the passage; for my

Voyages of an Old American Sea Captain

services he gave me two doubloons, not a small sum for a man in charity clothes and nothing in the pockets.

A passage of forty days brought us to New York. On closing up the voyage, my true friend Hanse, receiving his wages, divided the sum in his hands and generously offered me the half. His kindness and liberality touched my heart, but I was too honorable to accept the offer, especially as I could now jingle a couple of doubloons. Soon after this friend Hanse shipped in a brig bound to Demerara, where he died with yellow fever; peace to his ashes and honor to his memory. I immediately went to Berne (now Knox), Albany County, New York, where I remained for about two months.

Still looking hopefully toward "a life on the ocean wave," notwithstanding the ill augury of my first voyage, I returned to New York where I again shipped under my old commander, Captain Barker, who had also safely escaped from Brazil. We were now in the schooner "Lively" bound to the West Indies. This was a very pleasant voyage; we visited Nevis, St. Kitts and St. Eustatia. We returned to New York in September, 1801. I remained in New York till December; meanwhile I saw no one that I knew.

On a Whaling and Sealing Voyage to South Pacific Ocean

Early in December I again shipped under Captain Barker, now having command of the ship "Cayuga," belonging to the firm of Hoyt & Tom. We were bound into the South Pacific Ocean on a whaling and sealing voyage. Numerous and trying adventures now awaited me before I should again reach my home. We ran up and down the coast of Peru several times in search of sperm whale; in the space of a year and a half we took about one thousand barrels of sperm oil.

We ran into the river Tumbez on the coast of Peru to obtain a recruit

of wood and water. In our boats we visited the city of Tumbez. We also found here the English ship "Tom," whose captain had his wife with him, a Spanish lady that he had married at Gibraltar, who could readily speak both English and Spanish and was therefore our ready interpreter. Coming down one day from the city to the mouth of the river we chanced to have in our boat this captain and his wife and also a wealthy old planter going down to visit his estate near the river mouth.

The coast of Peru was very attractive. I cannot forget the many pleasant views that opened to us whenever we approached the shore. I have seen noble deer come boldly down to the beach and look off with the utmost unconcern upon us as if we had no power or disposition to disturb them.

Ashore on the Islands "Exactly Under the Equator"

We took occasion to visit the Galapagos Islands some six hundred and fifty miles from the continent and almost exactly under the equator. The islands are very rich. The prickly pear trees here are noble; some of them are twenty-five or thirty feet high with trunks as large as a man's body. We could supply ourselves abundantly with fish and flesh of the best quality. The water at times was literally alive with bonitos, a fish nearly as large as horse mackerel. There was also an abundance of albicore, a fish approaching the size of a porpoise and very delicate; the catching of these with huge hooks and nooses was rare sport. At any time numbers of green turtle were in sight. But we cared little for bonitos, albicore and green turtle in comparison with the turpin on the island. These are a thick heavy land turtle that never enter the sea. Their meat is very excellent; their tallow is a luxury and is as yellow as butter; their eggs too are a great delicacy. Great numbers of these turpin might

Autobiography of Jeremiah Holmes—Born 1782

be seen wandering beneath the groves of prickly pear waiting for the winds to shake down the fruit for their palates.

Our ship at last became leaky and we were compelled to put into Payta. Here the "Cayuga" was examined and finally condemned as unseaworthy. We could only sell her and close up our voyage, but in this we were hindered by various causes for nearly three months.

I now shipped on board of another whaler, the "Cold Spring of London," under Captain Dunn, and cruised again in the South Pacific. In about eleven months we took near two thousand barrels of sperm oil. We also visited the Gallapagos and laid in a supply of turpin, putting some of them in the hold on the top of our cargo. I recollect that some six months after we had taken these on board, when off Cape Horn, the carpenter, having occasion to go to the bottom of the pump well there found one of these turpin still alive, having crept over the top and fallen thus from our sight; this evidenced their capability of enduring hunger and thirst. We took our homeward voyage by the way of St. Helena, where we expected to obtain a convoy to London, as the English were at this time at war with France and Spain. It was now 1804, and my whaling cruises had occupied some two and a half years.

Captured by the French Privateers off St. Helena

On nearing St. Helena we discovered a sail in shore; but suspecting no danger we approached the vessel and spoke her. Her character was at once revealed. She was the "Bologna," a French privateer, mounting thirty-six guns and carrying more than a hundred men. We were her victim. It was now June, 1804. She took possession of us at about dark. Taking us on board the "Bologna" our ship was instantly sent off as a prize. We were kept on board

the privateer, however, only till the next day, when we were put into a boat and set adrift. Being only fifteen miles from the island we reached the shore in safety. Again I found myself in a foreign land, cast out, alone and destitute, after many toils and an absence from home of two and a half years. But severe trials were before me. I had now only the clothes that were upon my back.

Reaching the port of St. Helena I found no American consul and no American vessel; it was therefore a dark day for me. The rights of sailors at this time were not properly respected, and unhappily for me, I had now lost my protection papers. The best that I could do was to ship on board an English merchantman, the "Fame," commanded by one Captain Baker. But before the "Fame" was ready to sail my destination was sadly changed.

I was seized and pressed on board the English sixty-four-gun ship, "Trident." This occurred July 2, 1804. The "Trident," in fact, mounted about seventy guns and was commanded by Admiral Renier and bore his flag. When taken on board the "Trident" I was called up for examination by the first lieutenant. I at once said: "I am an American." He responded: "Well, we will make an Englishman of you." I answered: "No, sir; you will never do that."

I remained in the "Trident" but a short time when I was transferred to the sixty-four-gun ship "Athenian." We shortly sailed in company with the "Trident" and the frigate "Mediator" as a convoy to forty East Indiamen for the English Channel. We arrived at Dover in early autumn, when the Indiamen ran on their way while the "Athenian" ran back into Portsmouth to be hauled into the naval dock for repairs. From Portsmouth I wrote to the American consul at London seeking his interposition for my release. He obtained an order for my discharge, but in the teeth of right my claim was disre-

Voyages of an Old American Sea Captain

garded. I now sent letters to my kindred and friends in America to procure papers in evidence of my right.

Going to Assistance of Lord Nelson at Trafalgar

I was at last pressed on board the seventy-four-gun ship, "Saturn," now lying at Spit Head ready for sea, and appointed to join the fleet under Lord Nelson. The wind detained us. These winds blew in mercy to many on board the "Saturn," else we should have been with Lord Nelson off Trafalgar in that memorable naval action that cost so much blood, and where Nelson himself fell "On the field of his fame fresh and gory." We were unable to reach the scene till the battle had passed. The "Saturn" also conveyed six or eight vessels loaded with naval stores.

In passing the Straits of Gibraltar the French and Spanish gun boats from the shore ran out and attempted the seizure of one of our transports. The attempt was well-nigh successful but the wind springing up the "Saturn" hastened to the rescue and beat back the assailants. Quite an engagement now followed. The fort at Cabarena Point opened its fire in support of the shots from the gun boats. For about an hour and a half powder was burnt freely and the heavy iron hail flew merrily. In the skirmish I was stationed as captain of a gun on the lower deck. The "Saturn" played her part well and won the upper hand. Satisfying our opponents of our superiority and taking proper care of our transports we ran into the anchorage at Gibraltar and landed our naval supplies.

We next proceeded up the Mediterranean to the Spanish port of Carthage where we joined other naval vessels in the blockade of that place. Here we remained for several months. Finally we were informed that Jerome Buonaparte, Admiral of the French fleet, with a number of ships, had left Brest. We knew not his destination; he sailed, however, for the

West Indies. Our squadron was now ordered off the blockade of Carthage to Gibraltar.

We were ordered from Gibraltar to Cadiz to join Lord Collingwood in the blockade of that port. The blockading squadron numbered about twenty ships of the line. Here we continued in the "Saturn" for about two and a half years, occasionally running down to Gibraltar for supplies. But in the latter part of 1806 we ran down to Gibraltar to refit our ship and receive stores for another six months. During this time a few incidents occurred of the nature of episodes in my weary impressment.

In Service of Lord Collingwood During Blockade of Cadiz

From my first impressment, and especially after my imprisonment on board the "Saturn" I had been meditating plans and watching for opportunities to fly from the grasp of my oppressors. In one way and another during the past two years I had earned about seven guineas which I held as a shot in the locker. These guineas I closely wound in my neckcloth to have them at hand when an opportunity for escape should appear.

We took in water on the African side of the Straits at Tetuan Bay. While thus engaged I strolled from our party a little and then attempted concealment and flight, taking refuge in a vast field of growing wheat. It happened, however, that the sentinels stationed on the margin of the field to protect it discovered me by moving grain. I was first saluted with stones; but they soon found that I was no brute and desisted. I succeeded in conveying to one sentinel my character and situation. He said to me: "If you escape here you must turn Turk." I replied: "I don't care what I turn into if I can only get away from my impressment in the man-of-war." I offered him two guineas to secrete me in the grain and then assist me in reaching Centa Point opposite Gibraltar. He dared not accept the offer.

Autobiography of Jeremiah Holmes—Born 1782

I was obliged to return to the "Saturn's" company, only glad that my scheme was not known to the officers.

I now had the misfortune to suffer my patriotism to overcome my patience. While returning to Gibraltar, all hands having been treated to a drop for the cheering of the spirits, I was at my station in the main-top with a man named Silsby. As a Moorish galley passed us urged on by slaves chained to their oars I remarked to Silsby:

"How would you like to be on that craft?"

"Not at all," said he.

"It would be as proper for you to be there as it is for me to be here," I responded.

"Pshaw," said he, "you have as much right to be here as I have; you are no American, but some nobleman's bastard or else a runaway."

This was a word too much. I drew my fist and dealt him a blow between the eyes that laid him horizontally with a bloody nose. The fray was too open. We both were taken below, had our feet ironed, were laid on our backs and had our ankles strung on the iron rod arranged for the safe confinement of transgressors. In this uneasy attitude, strung like herring on the deck, we lay for three days consoling ourselves with bread and the confident expectation of a sound flogging. In the meantime four other disobedients were added to the iron rod. On the fourth day of our confinement, and it was the fourth of July, the criminal crew were ordered up to receive their penal lashes. It being Independence Day my spirit was stirred within me. I managed to scribble a note addressed to the captain to be handed to him in case I should be sentenced to be flogged. The note was to the effect that "if I should be flogged for the sudden and disorderly ebullition of my national and manly pride I would never lift a hand in the British service, be the consequences what they might."

Several received their two dozen

each, and, after the blood started freely, Silsby and myself were reserved to the last; this gave us a little hope. Silsby was brought forward and addressed: "This is the third time you have been put in irons; once for drunkenness; once for making disturbance, and now for quarreling. You are pardoned this time, but if ever caught in disobedience again, you shall be paid for old accounts and new." I was addressed in substance as follows: "This is your first misdemeanor; beware of the second; you are also pardoned."

An Attempt to Escape from the English at Gibraltar

I was exceedingly uneasy. I hated the English and utterly loathed their service. My unjust impressment chafed my free spirit and made me ready to accept almost any hazard for my freedom. While lying off Gibraltar at this time I attempted an escape by swimming. Some of the sailors were perfectly willing to wink at my endeavor, on the principle of dealing as they would be dealt by. On a chosen night I secretly slipped out of a forward port hole and let myself down into the sea. As I swam past the ship, the man in the yawl alongside whispered an inquiry after my plan. In a word I informed him, when, reaching his hand and grasping mine, he said: "God bless you; I hope you will succeed." The "Saturn" lay about two miles from the shore and a heavy current was setting past her and making directly for the land and I supposed ran near the shore which gave me my hope of success. I was deceived; the stream or tide very soon changed its direction and ran up the sea. I found that it would be impossible for me to reach the land across so swift a tide and that I should inevitably be swept by the waters far away into the Mediterranean to perish. Thus the path to my freedom was confronted by certain death. My skill in swimming was

Voyages of an Old American Sea Captain

not small, and it was taxed to the utmost. By taking advantage of an eddy that just now formed, and I think it was providential, setting the waters around me back towards the "Saturn," I made exertions to return. Using my best skill and strength favored by the eddy I at last succeeded in reaching the launch that was trailing at the "Saturn's" stern. I caught the cable of the launch and here rested a moment to recover myself and to plan for the future. I then slipped back on the cable, caught the bows of the launch and scrambled into her.

What now should I do? How could I get on board the "Saturn" again without being detected? Necessity is a mother. Concealed by the darkness I carefully hauled the launch up under the ship's stern and to the larboard stern port hole of the lower deck. The port hole was but little above the launch and was opened; and it opened by one-half downward. Creeping up I perched myself here with no little anxiety. The sentry on the lower deck was directly before me pacing his beat fore and aft and coming almost up to the port hole. I watched him and observed that he constantly looked straight forward and downward as if absorbed in thought, and when wheeling invariably turned on his left. I at once saw my only chance. As he wheeled to march from me I slipped through the port hole and tripping with my bare feet softly up behind him followed him on tip-toe the length of his beat and then, gliding on the right as he wheeled on his left, slid forward into darkness and noiselessly hastened to the hammocks among the sailors. My comrades were astonished. They had measured my chances with the tide and felt assured that I could never return to the ship. They almost believed me a ghost and looked upon my adventures as partaking of the marvelous.

An American's Appeal to His Country to Secure His Freedom

On returning from Gibraltar to resume our station in the blockading squadron off Cadiz, while standing in towards the squadron, the "Saturn" struck a reef and was seriously damaged. All our pumps were brought into play and we hastened back to Gibraltar. The ship was to be unloaded and hauled out immediately, and a hard job this was; we toiled like slaves. Her keel and bottom were finally repaired. During this time we were put on board the large Spanish seventy-four-gun ship, "St. John," taken by Lord Nelson and now used as a hulk. When the "Saturn" was made seaworthy again she was ordered to England for a more thorough overhaul. We immediately proceeded to Portsmouth and the ship was taken into the naval dock.

I now applied by letter the second time to the American consul at London for my discharge from the British service into which I had been unjustly impressed. I had managed to write to my kindred and friends in the United States at different times and particularly while at Gibraltar, informing them of my impressment and praying them to procure suitable papers in my behalf and send them to our consul at London. I knew they had faithfully attended to this brotherly duty and was aware that the consul had now many documents in my favor. The consul was the Honorable William Lyman, formerly of Hartford, Connecticut, and I felt assured that he would act in my behalf. I received no immediate response.

When I had been to Portsmouth about six weeks I received a letter from the consul stating that application had been made to the Lords' Commissioners for the Admiralty for my discharge, and an answer had been returned that my papers were insufficient. I was disappointed. I was indignant. I was thoroughly

Autobiography of Jeremiah Holmes—Born 1782

mad. My whole blood was hot. The legal flaw in my papers, it appears, was in the fact that they had not been ceremoniously endorsed by a regular custom-house officer—a mere trifle that gave occasion for a legal technicality that answered for the crown-serving lawyer to hang his crown-pleasing objection on. Thus persistently denied my rights and having suffered so long and so much I was well-nigh exasperated. I now raised my right hand and using strong words that I care not to repeat, swore strongly that I would never work more for the British crown. I meant what I said—bating the wickedness of my passionate words; and I was as good as my vow. Affairs were now to take some shape for the better or the worse.

Revolt Against Unjust Impressment in British Service

It was now Thursday noon, the fifth of November, 1806; and I had been in this dire slavery for about two years and a half. I had irrevocably determined to end it. Instead of going to work in the afternoon, I said to the officer of the deck that I wished to see the first lieutenant, Mr. Gregory Grant. My request was granted. Showing the lieutenant certain papers that I had received from Stonington, my native town, signed by the selectmen of the town, I said: "Mr. Grant, here are my papers from my native town in the United States, certifying my American birth and rights. I have received similar papers properly endorsed at five different times; some of these papers have been laid before the authorities by our consul; yet I am denied my rights. I ought to be discharged. And if I am not set at liberty I am resolved never more to work for the British crown, let the consequences be what they may." My language was bold and strong, but I spoke as I felt. The lieutenant replied: "It is my duty to take notice of such language as this and to punish you for it. Should I do my duty

I should put you in irons and send you on board the 'Royal William' out at Spit Head."

The "Royal William" was now a receiving ship. She was more than a hundred years old and was the first three-decker ever built by the English government.

Manifestly the lieutenant felt somewhat lenient towards me and so did not act up to the extent of his authority. He was a Scotchman and must naturally have felt a respect for a lover of freedom, who was suffering the privation of his dearest rights. He advised me to write further to our consul. I was excused from work for the remainder of the day and also for Friday and Saturday, which prevented a trial of my vow on board the ship by violence.

I immediately wrote again to our consul at London, stating more fully my situation and my just rights. I also addressed a letter to America to the Honorable James Madison, our secretary of state, informing him of my case and stating that my American papers had been rejected by the English authorities. I wrote these letters because I knew not what might be in the future, though I had now resolved to try the experiment of helping myself. Of course I could not wait for replies to these letters.

An American Ship Assists in Flight from Captivity

At this time we were on board a hulk, as the "Saturn" was in the dock. On Sunday morning I approached the lieutenant to ask, as some others had done with success, for leave to go on shore. Without waiting to hear my request he said: "There is no liberty for you." Modifying my first purpose I then said: "I only wish to go on board the American ship 'Medford.'" The "Medford" was from Boston and lay but a little distance from the hulk. The lieutenant finally gave consent for me to visit the "Medford" in the yawl under the charge of a midshipman. I did not choose to

Voyages of an Old American Sea Captain

go in this way. I was looking for a loophole in the direction of personal liberty.

I now went below and put on a second suit of clothes as far as I could without having the duplicates exposed to sight. While thus engaged a sailor, William Coffin, knowing my resolves and sympathizing with me, put his hand into his pocket and taking out all the money he had—only a few pence—handed it to me, adding: "There, that will help you a little in crossing the water; luck go with you." His generosity was heartily received, for I was now penniless, not having received my pay for service in the "Saturn."

It was now noon. Coming on deck I began to study how I might reach the shore or the American ship. There were wherries skulling about among the shipping to accommodate such as were going to and from the shore or among the ships. Acting as if I had full permission, when the lieutenant was out of sight, I beckoned a wherry alongside of the hulk and was going over the side when the sentry on that side of the ship stopped me. Just at this moment, however, the sentry on the other side of the deck—from an imperfect understanding of the interview that he had noticed between the lieutenant and myself, or perhaps from sympathy with me—interposed the remark: "I heard the lieutenant give him permission to go on board the "Medford." Touched by a little light of hope I now slid into the wherry and was skulled to the "Medford." Rarely did a mortal ever pay for so short a voyage more gladly.

It was a hopeful though trembling moment when I put my long wandering and long imprisoned feet on the deck of an American ship. I at once formed the acquaintance of the mate of the "Medford," Mr. Goram Coffin, of Nantucket, to whom I fully unfolded my situation. He was ready to stand by me as a brother. On inquiring of me, "From what part of

America are you?" I answered: "From Stonington, Connecticut." "Indeed," said he, "I am acquainted there!" In him I found a friend indeed. He then said: "Come, why not escape now?" I answered: "I have vowed never again to go on board a British man-of-war alive." He encouraged my vow. I added: "I want to reach London and see our consul myself. But how shall I get there? And how can I avoid detection on the way and keep out of the clutches of press gangs? It is seventy miles to London and I have no money, except a few pence given me by a sailor." He took from his pocket a one-pound note and extending it to me said: "There, you are welcome to that." Heaven bless him! He was willing to help a poor fugitive from oppression.

Fleeing to London on a Stage Coach in 1806

Mr. Coffin now took me on shore and we began to plan for my journey to London. We finally went to the stage office and learned that the regular coach would leave Portsmouth for London at six o'clock in the evening and that a passage on the outside would be only seventeen shillings and sixpence. Of course expedition would be economy and the most open ride would be the least suspicious. In the meantime I had armed myself with two good stout pocket-knives that I might command at any instant. I was not to be returned to a man-of-war without bloodshed, for liberty was born in my blood.

We retired to an inn and talked openly like Englishmen but privately of my best course of action. At six o'clock the stage horn blew when we hastened to the office where I paid my fare with no suspicious money and jumped upon the coach top. Speaking loudly so as to be heard Mr. Coffin called Mr. John Hix, as I had so registered my name on the stage books, and bid me give his respects to old acquaintances, giving their names

Autobiography of Jeremiah Holmes—Born 1782

and residences in London, and hoped that I should find my kindred and friends in health. The deception was managed artfully; we parted like old London cronies.

This night, the eighth of November, 1806, for its anxieties, its hopes, its fears, its long, dark, cold hours, made also impressive by wind and sleet, has a marked record in my memory. That seventy miles was traveled wakefully and thoughtfully.

On the rear of the stage was stationed a soldier as a guard. Shortly after starting he accosted me: "Well, shipmate, what craft do you belong to?" I was quick to answer: "To the man-of-war, 'Saturn.'" We talked freely; I told of sea adventures; he told of jolly sailors that had rode to London. No suspicion was awakened. At the relief stations I was merry and generous and so far treated the driver and guard as to draw my purse to only a remaining sixpence of the pound appropriated to my journey. I studiously kept up every appearance and profession of loyalty to the royal realm, lest detectives should scent my track. Upon the whole we were a merry company, at least, outwardly. There rode with us two soldiers, lately from Buenos Ayres, having inherited some property, who were flush with money and wine and song and cheering story, and thus aided to relieve the dark, chill, dreary night. I studied opportunities to make large English professions for my better security. As we passed near Lord Nelson's country seat and some one pointed in its direction, I observed: "Our nation met with a great loss in Lord Nelson's death;" but inwardly I was glad he was dead and wished half the nation dead with him.

Homeward Bound Across Atlantic a Free American Citizen

On reaching London, as it was extremely muddy, I had the politeness to help a lady passenger from the coach by taking her in my arms and

landing her safely on the sidewalk. Expressing suitable obligation for the favor she continued by asking in what direction I was going. I told her I wished to find the Royal Exchange and inquired how I might find it. She directed me to follow the street on which we stood till I reached London Bridge when the Royal Exchange would be full in sight. So my politeness received its recompense. I walked forward somewhat anxiously, thinking withal of the inquiries that were now on foot in Portsmouth for Holmes, the deserter. I was armed with my two trusty knives and I now carried them open though concealed to defend myself should a press gang lay hands on me. I felt that a certain part of the executive power corresponding with my inalienable rights was in myself and the tools of oppressors in the shape of press gangs would have found no mercy at my hands and no prize in me except my dead body.

I had previously learned that our consul's office was in a street adjoining the Royal Exchange. I soon found the office but it was closed. I waited near by revolving my problematic destiny and holding fast to my knives. Shortly the clerk appeared and opened the office. I immediately entered and made myself known. It was Lord Mayor's day and therefore a high day in the city. The consul was somewhere in the crowd witnessing the pageant. The procession finally passed the office and the clerk, discovering the consul, stepped out and informed him that "the Holmes who had so often written to him was in the office anxious to see him." The consul soon came in and I fully spread my case before him. Asking me various questions about Connecticut and Stonington, he became satisfied that I was no deceiver. His duty was plain. He ordered his clerk to furnish me with a protection. I had gained my great point. I had no more use for my open knives. I now had the hand and seal of liberty.

Voyages of an Old American Sea Captain

It was an hour of inexpressible relief and I stood up in the pride and dignity of an attested American citizen. But the more I rejoiced in my liberty and my endorsed rights the more I scorned and hated the English that had so long wronged me of my time and strength. And I was glad too that for my liberty I owed the haughty crown no thanks. I rather owed that which I exultingly endeavored, not without some success, to pay on the tenth of August, 1814, in the borough of Stonington.

My hatred to the English was only natural but was not altogether right. I now hastened to leave the loathed country and find my own sweet and free home. Searching for a homeward passage I shipped on board the "Powhattan," a merchant ship from Petersburg, Virginia, under command of Captain William Cottle. I need not say that I coveted for the "Powhattan" a quick passage and bounded across the Atlantic with a heart more buoyant than the waves or the winds.

Back in America After Five Years' Fearful Experiences

We reached the United States in March, 1807. I made no delay in finding old Stonington. After an absence of above five years, having passed through privations and imprisonment, and slavish toils and imminent perils, and goading insults, and now penniless, I was indeed happy to end the deep anxieties of my friends and to tread again the free soil of the region of my nativity. My experiences had prepared me to prize freedom.

The wars abroad among the European powers now brought on a state of general non-intercourse in commercial affairs which was soon followed by what was termed the long embargo. For a season therefore I remained about home, and in the meantime busied myself variously in farming. My restless thoughts, however, still roamed upon the sea. Mis-

fortunes had not quenched my seaward ambitions. I only waited the lifting of the war-clouds to launch again upon the treacherous but promising element. I accepted not disastrous beginnings as auguries of final defeat.

In March, 1809, I was married to Miss Anne B. (Denison) Gallup, daughter of Isaac and Eunice (Williams) Denison. This doubtless was the most fortunate as it was the happiest step of my life in respect to my temporal interests.

It being reported that the long embargo was about to close I sought an opportunity to again go to sea. Only seven days after my marriage I went to New York and sailed immediately for Liverpool as mate of the large schooner "Sea Flower" under Captain Peter Guifford, a Frenchman. We left port before the embargo closed so as to take the first chance in freights. The voyage occupied above eight months. The only incident of the voyage meriting notice was that of a most terrific hurricane which we experienced on our return passage off St. Johns. Not a shred of canvas dare we expose and death howled upon our track from the raging heavens and the boiling and surging deep. In all my fifty years' wanderings on the sea I have known no tempest that was its parallel. We reached New York in November.

I now left the "Sea Flower" for the coasting trade at home. I took a sloop in company with Manassah Minor and sailed south, trading in produce chiefly between Richmond, Norfolk and other ports on the Atlantic shore. Thus I passed the winter of 1809 and 1810.

In Coasting Trade on Atlantic Coast a Hundred Years Ago

In the spring of 1811 I joined a company who bought of Peck & Hallam of New London, the schooner "Sally Ann." I owned a fourth of the vessel, bought wholly on credit. I had just invested all my property in

Autobiography of Jeremiah Holmes—Born 1782

the erection of the dwelling that I still occupy (1859). We paid for the schooner five thousand eight hundred dollars. Simeon Haley was chosen captain and I was appointed mate. In June we sailed to Richmond, Virginia. Here we secured a cargo of tobacco for Bristol, England, receiving six pounds and two shillings per hogshead, making an excellent freight. In eight months from the time we sailed from Mystic I had cleared my part of the cost of the vessel, more than fourteen hundred dollars.

I was now put in command of the "Sally Ann" and ran her in the coasting business on the Atlantic shore till within a few weeks of the opening of the War of 1812, when I sold out to Simeon Haley.

Soon after the breaking out of the war I bought one-fourth of the famous sloop "Hero" and was appointed as her commander.

In February, 1813, I took the "Hero" to New York to receive a freight to Charleston, South Carolina. The great difficulties of the coast trade at this time made it profitable to such as dared to pursue it. On reaching New York we learned that the Chesapeake was blocked by a British squadron, and, knowing that the enemy's ships were hovering thickly on the whole coast, it was deemed very hazardous to attempt the contemplated voyage. Captain Potter and the other owners had their misgivings. I was ready to try the cruise relying upon the "Hero's" keel and the strength of her cordage.

I ran out to sea and for a day or so had no trouble. Some of the time I had the company of the pilot boat, schooner "Ulysses," cruising off the coast to inform Commodore Rogers of the blockade of the Chesapeake. My first anxiety was from five British ships of the line discovered close upon me during the night. Favored by the darkness and a skilful management of my canvas to avoid being seen and giving reins to the "Hero" on a run

I soon left the ships beyond the horizon. On another night I fell in with a single man-of-war that I dodged by like maneuvers. On a third night I was again surprised and the enemy, discovering me, turned and bent herself upon my track. The "Ulysses" was now in sight to the northward and on the shore side of me. The enemy soon turned her pursuit upon the "Ulysses," which was the larger vessel; meanwhile I turned to the eastward and so escaped. The "Ulysses" pressed canvas and carried away her mainmast, when the enemy came up and taking her crew prisoners, sent her to the bottom.

Adventures as Commander of the "Hero" in War of 1812

Only the night after this escape I was surprised by a bright light directly on my bow. In a moment I discerned five vessels of the British line standing directly for me. Instantly I bore away unseen by them, as in a moment they were busy making a tack and ran to the eastward; but soon shaping my course to southward again, before morning I ran into the midst of the same company and passed within a cable's length of a brig's bow, and yet again, as my fortune would have it, I was unobserved.

On a following night with the wind blowing well-nigh a gale and in the midst of a fog that was exchanged for rain, I found a large three-decker just aft and a heavy ship just ahead plunging on their way. I again concealed myself by taking in my sails till a little distance made it safe to put the bone again in the "Hero's" mouth.

Thus with playing hush and dodging and scudding, all with sleepless anxiety and yet confidence in the good "Hero's" keel, canvas and helm, after a passage of about six days, I ran over the bar into Charleston Harbor to the no little astonishment of the people in the city; for only the day before a ship and a brig were prowling in the offing on the lookout for victims, and had succeeded in captur-

Voyages of an Old American Sea Captain

ing the schooner "Federal Jack," then in the government service supplying lighthouses with oil and other necessities. The collector of the port at once asked me if I had a license for my cruise from the English. I told him my only license was from the custom-house in New London. He seemed astonished at my daring and success.

I lay in Charleston about two weeks discharging and making ready and taking in freight for my return voyage. I laid the "Hero" ashore, scrubbed and tallowed her that she might make a clean furrow. I found here the "Nimble," under Captain John Rathbun, and the "Revenue," under Captain Forsyth, both from Mystic. These sailed the day before me, heavily loaded, and were captured off Cape Hatteras by Admiral Warren and were taken to the Chesapeake when the crews, with about two hundred other prisoners, were put on board the frigate "Junan" and carried to Bermuda. I took in a reasonable load of cotton and other articles and started on my homeward dodge.

About the third day out I fell in with an English frigate off the capes of the Chesapeake. She gave chase and pursued me from morning till evening. As darkness came on she was within two gun-shots of me. Under cover of the night I took in my small sails and hauled in towards land and then tacking to the north and taxing my spars successfully eluded the enemy's reach.

"Gentlemen, You Have Got to Fight or Go to Halifax!"

I met no other danger till I neared the island of No Man's Land, when, at daylight, I discovered a brig on my weather quarter busy making sail. The wind was now north. I at once spread all my canvas and squared away before the wind. The brig came bounding after me. I had a clear track for about two hours and I measured my knots right handsomely. I now made two English frigates

directly on my bow. This gave me a shorter berth than I could have desired. But despair never shipped on board the "Hero," nor was her keel made for a prize. I jibed and stood to the eastward. I now had the brig on my quarter and the frigates astern and one of the frigates immediately gave chase; the other had a schooner in care. I bid the "Hero" do her best and helped her as best I could. A little relief, however, unexpectedly arose from the character and fears of the brig.

The brig proved to be an English privateer, the "Sir John Sherbrook," of Liverpool, Nova Scotia, a very famous craft that took not a few prizes on our coast during the war. She did not wish to come under the reach of the frigate lest, in obedience to her superior, she should be compelled to give up a portion of her men for the frigate's use; she, therefore, gave the frigate a reasonable berth, but she still hung upon my course as best she could with her own interests in view. She hauled her wind to the northward. I was now running to the eastward, but I shortly headed towards Martha's Vineyard.

The wind now died away, and we were close in to No Man's Land. The brig lowered her boat armed with muskets and prosecuted the chase. The frigate had now given up the chase and returned to seek her consort. The brig's boat pressed so closely upon me that the man in her bow with a musket fired upon me and put a number of balls through my sails. But for my consideration this bowsman would have lost his life. I had three passengers on board; one of these was a Mr. Spencer of Vermont, who had a prime rifle, and proposed to prove his expertness with his piece at the same time that he should evince his patriotism by laying this armed bowsman in the bottom of the boat. I requested a little delay. Counting upon what might occur I made the "Hero" ready for defense. I said to my passengers: "Now, gen-

Autobiography of Jeremiah Holmes—Born 1782

tlemen, you have got to fight or go to Halifax." We had no relish for Halifax. I had the men and passengers at work at once, and I locked the companion-way to hold all the strength on deck. We arranged the bales of cotton in tiers like a bulwark. I then had a quantity of ballast stones and all available arms ready to give the privateer a suitable reception. Fortunately, however, at this moment, when affairs were about to come to arms, a breeze sprung up that filled the "Hero's" canvas and I soon left the assailant with no other choice than to return to the brig.

Triumph of the "Hero" and Her Welcome Home Again

I now ran between No Man's Land and a reef and stood on to the northward. The brig dared not follow, but remained outside and was becalmed.

The brig had an American Jack from her fore-top-gallant mast-head for a pilot. My mate suggested that

we should run down and put him on board as a pilot that he might realize a few hundred dollars for carrying her into Newport. I replied: "I shall neither board any vessel nor be boarded till I reach a good harbor." Nearing land we fell in with a number of small fishing vessels. One of these, the smack "Fair Haven" of Edgartown ran down and furnished the brig with a pilot.

I had a good breeze in shore and I made the best of it. With a change of wind I now put my head in for Point Judith. By four o'clock in the morning I was off Watch Hill. Lying here with jib to my mast till morning broke I discovered the privateer brig abreast of me not a mile distant. Making all sail I stood through the reef and before sunrise the "Hero" ran into Noank in Mystic River, where I was most heartily welcomed by my owners and friends who, not without reason, praised the "Hero's" success and wondered how I had so successfully run the gauntlet through so many ships of war.

MARRIAGE CONTRACT IN AMERICA IN 1675

Transcribed from Original by MARY R. WOODRUFF

Know all men by these presents, That I, William East of Milford, in ye County of new-haven, in the Colony of Connecticut in New England, Do upon ye Contract of marriage with mary Plume of the same Town Widdow, give, bind and make over my dwelling hous and homlett, and all my Land both arrable and meadow ground within ye bounds of Milford; And I Doe Further Ingage that the sd mary Plume and her heirs shall quietly and peaceably enjoy all and Singular the premises above sd with the Barne and outhouses forever after my decease, or Two hundred pound which she pleaseth, without any lett or mollostacon from any person, persons, from, by, or under me ye shall lay Claime thereunto: The above sd promises I Do make over unto ye sd mary as a Dowrie or Jointure upon the Anot. aforesd, and this to stand in force to all intents and purposes immediately upon the Confumation of marriage, or if it please God to take me away by death before marriage, yet this to stand in full power, force and vertue; Further I, the sd William East, doe hereby promise and Engage not to Claime any interest in any of her Estate either reall or personall (by vertue of her interest) But do leave ye same fully, and whoely to herself to dispose when and as She pleaseth, In witness whereof I have hereunto set my hand and seale this 4th day of January 1675.

Signed and delivered in presence of us (Signed) WILLIAM EAST.
DANIEL BUCKINGHAM SAMUELL EAST.

Tavern and Post Road & By Norman Talcott



IT is not long since the great network of thoroughfares that cross and counter-cross the Western Continent, and over which some eighty million people now pass, were but rough trails through dense forest wilderness.

Then as the axe blazed broader paths and the trails widened, the turnpike and the post-road stretched through the woodland and fields, winding its course over hills and down the slopes into the valleys, joining the neighboring villages.

Not long ago a single highway was the sole artery between New York and Boston, taking and bearing onward all the life and traffic which flowed into it from the smaller arteries leading from the less populous

villages and settlements. So important a part did this road have in the early life of the nation that there is hardly a momentous event in her history which it does not recall.

Along it rode His Majesty's governor of New England, Sir Edmund Andros, as he journeyed to take his seat at Boston. In 1775 spurred over it the messenger who bore the news of Lexington, and through its dust resolutely trudged the trained bands that in answer to his summons hurried to the relief of Boston. Later it was traveled by Washington and Lafayette and other great men who received, from the country people dwelling on it, ovations amounting almost to worship.

The notes of the post horn brought the good folk of the towns along the way hurrying to their windows and



STONE STEPS WHERE PUTNAM ON HORSEBACK ESCAPED FROM THE BRITISH

doors to see the coach roll in with its cargo of mail and passengers from the outside world.

Among the Colonial and Revolutionary hostleries which were scattered along the Post Road between New York and Boston, none is more intimately linked with the life of early days than the old Israel Knapp Inn, in Greenwich, Connecticut, which was the headquarters of General Israel Putnam for a time in 1779, and where he was surprised by the British on the day of his daring ride down the stone steps, the tale of which is so dear to every American school-boy.

The house must have been built about two hundred years ago. The land on which it stands was bought in 1692 by one Timothy Knapp, and there is in the Greenwich Land Records a deed of a gift of a half of the

house and land to his son, Israel Knapp, in 1729. The erection was of course between these two dates. From earliest times it was used as an inn, and its hospitable roof has covered many a famous man who journeyed on horseback or in stage coach between Boston and New York.

In 1766 the town records show that a meeting of freeholders was held at the house of "Israel Knapp, Innholder." In this house were held meetings of one of the first Masonic lodges in America, and in recent years while repairs were being made, certain of the regalia was found and is now in the possession of Acacia Masonic Lodge of Greenwich.

The really interesting period in the history of the place begins with the American Revolution. During most



CELLAR STAIRS IN THE OLD KNAPP TAVERN WHERE THE TORIES CONGREGATED

of the war Greenwich was debatable ground. Much of the time there were American troops stationed in the town, but there were frequent raids by the British soldiers and by the hands of guerillas, known as "cow boys," while a large proportion of the inhabitants were loyal to the "crown."

Among the most inveterate Tories was the inn-keeper, Israel Knapp, and it is said that his tavern was for a long time a secret meeting-place for those who sought to defeat the patriot cause. It is certain that he was held in ill-repute by all good patriots, and his name was on the dangerous list held by the local "committee of safety."

Connected with the cottage is a most romantic, though dismal tale. The old inn-keeper's favorite son,

Timothy Knapp, though as ardent a Tory as his father, was in love with the beautiful daughter of the patriot, Jonathan Mead, who lived nearby. Tradition says that the girl reciprocated his affection, but she was imbued with a spirit of loyalty to the cause of the Revolutionists that made her indignantly refuse when Timothy sought her hand in marriage. The youth, as might be expected, was deeply hurt.

He called to her reproachfully and angrily as he left the house that evening: "You shall speak to me one day, but I shall never answer you!"

He little knew how true were his words. One evening shortly afterward when he was approaching the house, perhaps to make another attempt to win the maid, her father, mistaking him for a "cow boy"

Tavern and Post Road of Long Gone Days

marauder, shot him through the heart. The girl, recognizing him, threw herself upon his lifeless body and implored him to speak, but he was dead and unable to answer to the caresses that were showered upon him. The body lies buried on the grounds of the ancient inn.

On the 26th of February, 1779, General Israel Putnam was staying in the house when surprised by a large party of British and Tories under General Tryon. The story relates that the general, old gallant that he was, that night escorted a pretty maiden, Mistress Bush of Cos Cob, to a dance in a part of the town known as Pecksland, and did not return until the wee small hours of the morning. It is only reasonable to assume that he did not rise early after he had retired. Tradition also affirms that he was shaving in the morning when an American officer, one Titus Watson, rode in and informed him of the approach of General Tyron with a large force of British and Tories along the Post Road from New York. He hastened to the Congregational meeting-house, which was but a few rods west of the Knapp tavern, and drew up his little body of Continentals. Resistance by such a small force was futile, and after the first volley Putnam ordered his men to seek safety wherever they might find it, and himself started on a gallop toward Stamford for reinforcements.

A quarter of a mile east of the Congregational Church is a precipitous and rocky hill, now known as "Put's Hill." In it were cut steps, twenty-four, it is said, in number, whereby on Sundays the members of Christ Church, the Episcopal Church at the top of the hill, ascended. The British were confident that they had captured the American general when they saw him spurring his horse toward the steps. Not so, however. With reckless daring he galloped his horse down the stone steps, turning in

the saddle as he went, shaking his fist and calling out, defiantly: "God cuss ye, I'll hang ye to the next tree when I get ye."

The astounded dragoons reined up at the head of the steps, catching a glimpse of the "flying horseman," looked at one another in bewilderment. Putnam returned that day with reinforcements in time to capture a considerable number of them as prisoners.

One of the eye-witnesses of the daring ride was Rose Fitch, an old slave woman belonging to Jabez Fitch, who lived on the brow of the hill. She died in Port Chester about sixty years ago at a very advanced age. Mr. Thomas T. Tompkins, of Port Chester, who is now about eighty years old, tells the story which the old slave woman related to him when he was a boy.

"I was standing at the gate on the morning when the British raided the town," she often told me," said Mr. Tompkins to the writer. "I had heard the firing near the Congregational Church, and like everyone else in town, had rushed out to see what was the matter. As I looked down the road I saw a man riding up the road at a break-neck pace. Hardly a hundred yards behind him rode a dozen or more men in scarlet uniforms.

"Across the brow of the hill ran a stone wall in which there was an opening at the point where the pathway reached the summit. Leaving the main road the first horseman dashed straight through and down the pathway which was very steep and in which a number of steps were cut. The men who followed reined up at the stone wall and were silent for a moment as if astonished. Then they fell to arguing with one another, and later rode away. I did not know at the time who the daring rider was, but was told later that the man was General Putnam and that his pursuers were British soldiers."

Home Life in Early America



Remembrance wakes, with all her busy train,
Swells at my breast—
How often have I loitered o'er thy green,
Where humble happiness endeared each scene.

Home Life in Early America

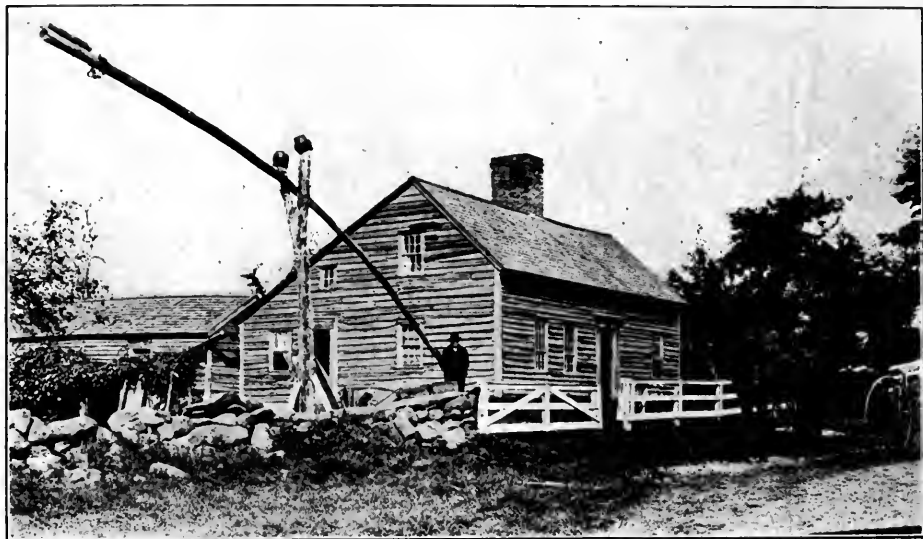

TYPICAL AMERICAN HOMES IN FIRST YEARS OF THE REPUBLIC



THE OLD CHIMNEY CORNER



THE OLD OPEN HEARTH



THE OLD WELL SWEEP

Home Life in Early America



BUILT IN 1640 AND BELIEVED TO BE THE OLDEST ANCESTRAL ESTATE IN AMERICA
In Continuous Possession of the Descendants of its Pioneer Builder, Joseph Loomis
At Windsor, Connecticut



SPACIOUS HOME A CENTURY AGO



OLD MANSION OF YEARS GONE BY

In the First Homes in America

BY CLARA EMERSON BICKFORD



CLOCK BELONGING TO BENJAMIN FRANKLIN

THE first houses in America were small and rude, but very soon commodious and comfortable dwellings were built, filled with furniture that has nothing suggestive of the frontiersman. A thousand pounds was a great sum of money in those days, but before 1650 there were plenty of men in America who were worth more than that amount. The wealth of the settlers consisted of clothing, cotton, linen, woolen and silk stuffs; and tools, implements, vessels and utensils of iron, pewter, brass, wood and earthenware. Thomas Morton, writing in 1632, said that there was need of the tumelor or cooper, smiths, carpenters and shopkeepers. He complained of excessive prices, saying: "If they do not gain Cent per Cent, they cry out that they are losers." The first houses were constructed of rough-hewn timber with window-panes of oiled glass and the roofs thatched. The hearths were laid with stones and clay and the huge chimneys were raised outside the walls. Edward Winslow writes in 1621, "Bring plenty of clothes and bedding, fowling pieces, and paper and linseed oil for your windows with cotton yarn for your lamps." In 1629 Higginson writes to his friends in England, "Be sure to furnish yourself with glass for windows." Men of position, wealth and learning came to America. In 1638 Winthrop notes in his diary: "Many ships arrived this year, with people of good quality and estate, notwithstanding the Council's order that none such should come without the King's order." Among those who intended to come, history mentions Oliver Cromwell himself. Along the Atlantic coast log-houses and rough abodes developed into commodious homesteads and spacious mansions. This was the foundation of the home-life that has since become one of the dearest treasures in America, and even to-day many of the truest Americans hold in trust the home furnishings of some of the first homes in the American Republic.



Types of
Early Furniture in America
Rare Antiques in Possession of
Mrs. John Marshall Holcombe
at Hartford, Connecticut

In the First Homes in America



AN AMERICAN HOME DURING THE LAST CENTURY



TAP ROOM IN WAYSIDE INN, SUDBURY, MASSACHUSETTS; CONTAINING DESK USED BY DANIEL WEBSTER, AND THIRTEEN ANTIQUE CHAIRS FROM FLAGSHIP "HARTFORD"

Ancient American Landmarks



THE PASSING OF THE OLD LANDMARKS

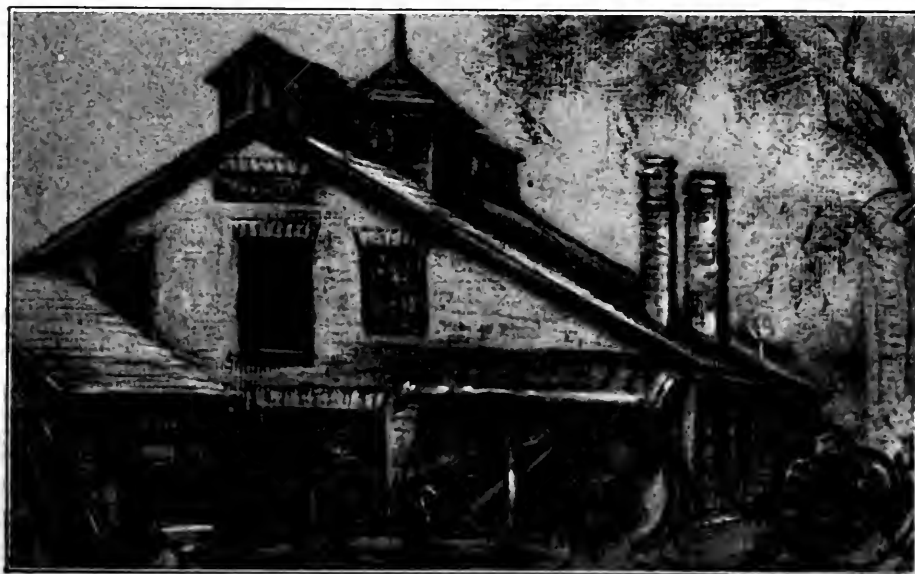

THE FIRST DAYS OF AMERICAN INDUSTRY



MODERN AMERICAN SCULPTURE
The "Aztecs" by Louis A. Gudebrod
Member of the National Sculpture Society

An Indian Legend—The Flight of Red Bird

BY

JOE CONE

OF CAMBRIDGE, MASSACHUSETTS

ON the heights above the river,
Looking southward to Long
Island.
Stood the Indian home of Obed,
Stood his cabin lone and high;
With him lived his comely daughter,
Lived his only daughter "Red Bird,"
She a robust, lovely maiden,
And the apple of his eye.

She had lovers from the Pequots,
She had lovers from the Island,
All the braves for miles around her
Sought her hand but all in vain;
To their tales she would not listen,
For her heart went out to "White Face,"
He the mighty Yankee hunter
Of the forest and the plain.

Obed, stern and true to nature,
With disfavor looked on "White Face,"
And forbade his daughter "Red Bird"
To the hunter's ardent gaze;
Then within the darkened forest
Did he meet her clandestinely,
While their hearts sang love's hosannas
Through the silent summer days.

Then a watchful, spying Pequot,
Who was haunting stream and forest,
Came upon the happy lovers,
And to Obed told the tale;
Obed full of wrath and hatred,
Ever after, in his absence,
Locked his daughter in the cabin,
Where she silent grew and pale.

One day Obed came from Saybrooke,
Where he'd been attending worship,
For 'tis said he was converted,
And he found his daughter fled:
She had taken her belongings,
And her trail led to the river,
Where in direful consternation
Broken hearted Obed sped.

Print of maid and print of lover
Did he trail through field and meadow,
Till at last he reached the river,
Where her birch-bark was no more;
Far out on the waters rolling,
From the storm that was arising,
Could he see the lovers fleeing
For the dim Long Island shore.

Then the storm broke loose with fury,
And the shell-like craft was beaten
On the mad waves like a feather
Till 'twas lost from human sight;
Obed, dazed and bent with sorrow,
Turned him back unto his cabin,
Now a place of chill and darkness,
Cursing "White Face" through the
night.

Gone his only daughter "Red Bird,"
Gone the hope and joy of Obed,
Last of tribe and name of Obed,
On the treach'rous Saybrooke shoal.
Sought he then the sacred boulder,
Known to fame as "Obed's Altar,"
Where he threw himself in sorrow
And in agony of soul.

Sunday came, the church was opened,
But no Obed came for worship,
And they wondered at his absence,
Seldom had he staid away.
When they sought him on the morrow
Dead they found him on his altar,
On his altar on the hillside,
Where it stands in peace today.

The First Patent in America

Granted in 1646 to the Inventor of "an engine of mills to go by water" and recorded as "Jenkes Anpolge"

BY

EMELINE JENKS CRAMPTON OF ST. CLAIR, MICHIGAN

A LINEAL DESCENDANT OF THE PATENTEE

At a generall courte at Boston the 6th of the 3th mo 1646 The Cort considringe ye necessity of raising such manufactures of engines of mills to go by water for speedy dispatch of much worke wth few hands, and being sufficiently informed of ye ability of ye petitionr to pforme such workes grant his petition (yt n othr pson shall set up, or use any such new invention, or trade for fourteen years wtout ye licence of him ye said Joseph Jenkes) so far as concernes any such new invention, and so as it shalbe always in ye powr of this corte to restrain ye exportation of such manufactures, and ye prizes of them to moderation if occasion so require.

THE first patent in America was granted to Joseph Jenks, the first, a founder and machinist who had emigrated from Hammersmith, England, where he was born in 1602. He was "a very ingenious man," and was induced by Governor Winthrop, the younger, to come to Lynn, Massachusetts, about 1642, as master mechanic, to establish "the iron and steel works." He is the acknowledged head of the iron-smelting and founding business, and the first builder of machinery in this country, and first patentee of inventions in America, having introduced the idea (first granted by act of Parliament in 1625) of protection for the manufacture of improvements by petition to the government of Massachusetts Bay. In 1646 he took patents for mill improvements; and in 1655 he patented the present form of the grass scythe, for which "he should

be held in grateful remembrance." In 1652 he made dies for the first coinage of money, the "Pine Tree Shillings." In 1654 he built the first fire engine, to the order of "the selectmen of Boston" (the first ever built in the country); in 1657 he built a forge, and entered upon the manufacture of his improved scythes nine years before his application was granted.

Inventor Jenks was a widower and left two sons, Joseph, eleven, and George, in England, who early followed him to America. He married again in Lynn, and had three sons and two daughters. His son, Joseph, was born in England in 1632, followed his father to Lynn about 1647, and served at his business; he subsequently went to Providence, Rhode Island, and established the iron and machine business at Pawtucket Falls, founding the town of Pawtucket. His shops were destroyed in King Philip's War, but were rebuilt. By his enterprise the

The First Patent in America in 1646

foundation was laid which made that town the great "iron workshop of the colonies," and the place where skilled mechanics gathered, who have since made Rhode Island noted for her steel and iron products, machinery and other manufactures.

The manufacture of firearms began to be carried on extensively in this place by Stephen Jenks; and several independent companies were furnished with arms of home manufacture. Sixty heavy cannons besides field pieces were made at the iron works.

Inventor Jenks came from an old family abroad. The surname is spelled Jenks, Jynks, Jenkes, Jencks, and Jenckes. This family is descended from the Welch or ancient Britons. Robert Jenks was of Wolverton (manor) parish of Eatounder-Eywood, Shropshire, about 1350, in the reign of Edward III. This gentleman was the son of Jenkyn Cam-

brey of that place and Dorothy, daughter and co-heiress of Sir Walter Collyng, Knight, of Church Stretton, in the same county. From Robert, the ancestry is traced to Sthelstan, who reigned from 925 to 941, the head of the fourth royal tribe of Wales. Sthelstan was descended from Vortigern, who ruled the Britons from 454 to 485 A.D., and seven generations beyond Caractacus—as far as Welch annals and Bardic pedigrees are carried. At Wolverton it continued for ten direct descents and families branched therefrom. Herbert Jenks, Esquire, possessed Wolverton about 1640 and his estate fell to his heirs by a daughter. From this ancestry was Joseph Jenks, the first patentee in America.

Inventor Jenks' grandson was distinguished in his service to Rhode Island and was assistant governor for eleven years, and governor from 1727-1732—five years.



THE FIRST ENGLISH-SPEAKING AMERICAN HOUSEHOLDS



THE HEART OF THE AMERICAN DOMINION A GENERATION AGO



THE CONQUEST OF THE AMERICAN WILDERNESS
Prints from Honorable William Henry Milburn's "In the Valley of the Mississippi"

Great Heart of the American Dominion

Narrative of
a Journey in the Wilderness
of the Mississippi Valley in 1789-1790 &
Experiences in Vast Region that is Gaining Control
of the American Nation and now Contains Twenty-two of the
Forty-five United States & Travels in the Early Days of American Republic

BY

MAJOR SAMUEL S. FORMAN

FROM THE ORIGINAL MANUSCRIPT NOW IN POSSESSION OF HIS FAMILY

THE great precursors of civilization have nearly all come within the memory of the generation that is now passing. Wonderful are the scenes that have been enacted before the eyes of the silver-haired men and women who are now turning their faces from the great drama of a world's unfolding and lifting their arms in willingness to the Infinite Power. It is hard to conceive what the next generation will witness along this triumphant march of progress.

Many men now of middle age knew Major Samuel S. Forman and have heard him tell his experiences on a journey down the Mississippi Valley when it was a vast wilderness, with only here and there a small settlement fortified against the Indians. While he was relating his adventures the wilderness disappeared as if by magic, until to-day the very men who heard his lips repeat the story are traversing the scene and erecting upon it temples of civilization.

As we read these words, twenty-two of the forty-five states of this American Republic are wholly within this wilderness of yesterday—the Mississippi Valley. With Oklahoma and Indian Territory admitted as one state, it will make the twenty-third and give the Mississippi Valley a majority of the United States, ultimately controlling the nation, politically and

financially, and “establishing the seat of the American Dominion in the great heart of the continent.”

When Major Forman made his notable journey into the wilds of the Mississippi Valley, he found Pittsburg but a few log-houses in the forest, and it was with difficulty that land could be disposed of at fifty cents an acre or hundred-acre-tracts for fifty dollars each. To-day it is the greatest industrial city on the Western Continent, spanning the Monongahela river with the finest and largest structure in American civilization, a million dollar terminal on the very site of old Fort Duquesne, and its railroad bridges handling more traffic than any other locality in this country. All along the route taken by Major Forman, rich and beautiful cities have been similarly built and it is with these in mind that the major's adventures become intensely interesting.

Major Forman was born in Middledletown Point, Monmouth County, New Jersey, July 21, 1765, and related this story shortly before his death at the age of ninety-seven years, August 16, 1862, in Syracuse, New York. The manuscript of his adventures was secreted for nearly forty years, when Honorable Lyman C. Draper had them preserved in a brochure in Cincinnati. The record here given is contributed by Mrs. Breese Stevens of Madison, Wisconsin.

Journey in the Mississippi Valley in 1789

GENERAL DAVID FORMAN, of New Jersey, entered into a negotiation with the Spanish minister, Don Diego de Gardoque, for his brother, Ezekiel Forman, of Philadelphia, to emigrate with his family and sixty odd colored people, and settle in the Natchez country, then under Spanish authority.

I agreed with General Forman to accompany the emigrating party; and, about the last of November, 1789, having closed up my little business at Middletown Point, New Jersey, I set out from the general's residence, in Freehold, with Captain Benajah Osmun, an old continental captain, who was at that time the faithful overseer of the general's blacks. There were sixty men, women, and children, and they were the best set of blacks I ever saw together. I knew the most of them, and all were well-behaved, except two rather ill-tempered fellows. General Forman purchased some more, who had intermarried with his own, so as not to separate families. They were all well fed and well clothed.

Traveling in a Caravan in America in 1789

We had, I believe, four teams of four horses each, and one two-horse wagon, all covered with tow-cloth, while Captain Osmun and I rode on horseback. After the distressing scene of taking leave—for the general's family and blacks were almost all in tears—we set out upon our long journey. The first night we camped on the plains near Cranberry, having accomplished only about twelve or fifteen miles. The captain and I had a bed put under one of the wagons; the sides of the wagon had tenter-hooks, and curtains made to hook up to them, with loops to peg the bottom to the ground. The colored people mostly slept in their wagons. In the night a heavy rain fell, when the

captain and I fared badly. The ground was level, and the water, unable to run off, gave us a good soaking. I had on a new pair of handsome buckskin small clothes; the rain spoiled their beauty, and the wetting and subsequent shrinkage rendered them very uncomfortable to wear.

Leaving New Jersey on Long Journey into the Middle West

The next morning we commenced our journey as early as possible. We drove to Princeton, where we tarried awhile, and all were made comfortable. We crossed the Delaware five miles above Trenton. On arriving at Lancaster, in Pennsylvania, the authorities stopped us, as we somewhat expected they would do. General Forman had furnished me with all the necessary papers relating to the transportation of slaves through New Jersey and Pennsylvania. While Judge Hubley was examining the papers, the servant women informed me that the females of the city came out of their houses and inquired of them whether they could spin, knit, sew, and do housework, and whether they were willing to go to the South; so, if the authorities stopped us, they could all soon have new homes. But our colored women laughed at the Lancaster ladies, who seemed mortified when they learned that we could not be detained.

In Westmoreland county we had a little trouble with a drunken justice of the peace and some free blacks. These free blacks, as we learned from a faithful old colored woman, furnished the two ill-tempered blacks of our party with old swords and pistols, but nothing serious grew out of it.

The weather began to grow very cold, the roads bad, and traveling tedious. We encamped one night in the woods, kindled a fire, and turned the tails of the wagons all inward, thus forming a circle around the fire. Another night we came to a vacant cabin without a floor; we made a

The Great Heart of the American Dominion

large fire, and all who chose took their bedding and slept in the cabin, some remaining in the wagons. The captain and I had our beds spread before the fire.

Camping in the Forests of the Alleghany Mountains

One Saturday evening, we were apprehensive of being obliged to encamp again in the woods. I went ahead, hoping to find night quarters. I rode up to a log house and went in; it was growing dark, and I began to ask the landlord to accommodate us for the night, addressing myself to a tall, lean man. Before I got through with my inquiry, he caught me up in his arms, as if I were merely a small child, and exclaimed: "Mighty souls! if this is not little Sammy Forman," and, hugging and kissing me, added, "Why, don't you remember Charley Morgan? Yes, you can have anything I have, and we will do the best we can for you." This was somewhere in the Alleghany mountains, and here we remained till Monday, buying wheat, and sending it to mill, and converting a fat steer into meat, so that we were well provided for, for awhile. This Charley Morgan entered the regular service as a corporal in my brother Jonathan's company, when he was a captain, and raised his company in the vicinity of Middletown Point, New Jersey. He could ape the simpleton very well, and was sent as a spy into the British army, and returned safe with the desired information. I was surprised to meet him in this far-off mountain region.

Somewhere about Fort Littleton or Fort Loudon, our funds ran out. When we left General Forman, he told me that Uncle Ezekiel Forman would leave Philadelphia with his family, and overtake us in time to supply our wants. But he did not start as soon as he expected, and on his way in the mountains the top of his carriage got broken by a leaning tree, which somewhat detained him.

so that we arrived at Pittsburg two or three days before him.

One morning, while in the neighborhood of Fort Littleton or Fort Loudon, I offered to sell my horse to the landlord where we took breakfast; he kept a store as well as a tavern, and was wealthy. The price of the horse I put very low, when the landlord asked why I offered him so cheap. I informed him that I was out of funds and had expected that Ezekiel Forman, who owned the colored people, would have overtaken us before our means became exhausted. He replied: "I know your uncle, and I will lend you as much money as you need, and take your order on him, as he will stop here on his way. Now, step with me to the store." Pointing to the large piles of silver dollars on the counter in the store, he said: "Step up and help yourself to as much as you want, and give me your order." This was an unexpected favor. When uncle arrived, he satisfied the order.

It took nearly three weeks to cross Pennsylvania

It had taken us near three weeks to journey from Monmouth to Pittsburg. After our arrival at this place, our first business was to find situations for our numerous family, while awaiting the rise of the Ohio, and to lay in provisions for our long river voyage. Colonel Turnbull, late of Philadelphia, and an acquaintance of uncle, politely offered him the use of a vacant house and store-room, exactly such apartments as were wanted. The colored people were all comfortably housed also.

The horses and wagons were sold at a great sacrifice—uncle retaining only his handsome coach horses and carriage, which he took to Natchez on a tobacco boat, which Captain Osmun commanded, and on board of which the colored field hands were conveyed. These boats were flat-bottomed, and boarded over the top, and appeared like floating houses.

Journey in the Mississippi Valley in 1789

Uncle's boat was a seventy feet keel-boat, decked over, with a cabin for lodging purposes, but too low to stand up erect. The beds and bedding lay on the floor, and the insides lined with plank to prevent the Indians from penetrating through with their balls, should they attack us. We had a large quantity of dry goods, and a few were opened and bartered in payment for boats and provisions.

On board of the keel-boat, uncle and family found comfortable quarters. Mr. and Mrs. Forman, Augusta, Margaret, and Frances, aged about nine, eleven, and thirteen, and David Forman and Miss Betsey Church, the latter housekeeper and companion for Aunt Forman, an excellent woman, who had lived in the family several years, and occasionally took the head of the table. I and five or six others, two mechanics, and about eight or ten house servants, were also occupants of this boat.

The family received much polite attention while in Pittsburg. By the time we got prepared for our departure, the Ohio river rose. We tarried there about a month. Both boats were armed with rifles, pistols, etc. It being in Indian war time, all boats descending that long river, of about eleven hundred miles, were liable to be attacked every hour by a merciless foe, oftentimes led on by renegade whites.

Embarking at Pittsburg for a trip down the Monongahela

Uncle fixed on a certain Sabbath, as was the custom in those days, to embark on ship-board. On that day, the polite and hospitable Colonel Turnbull, then a widower, gave uncle an elegant dinner, and invited several gentlemen to grace the occasion with their presence. After dinner, which was not prolonged, we embarked on board our little squadron. Colonel William Wyckoff, and his brother-in-law, Kenneth Scudder, of Monmouth county, New Jersey, accompanied us on our voyage. The colonel

had been, seven years previous to this, an Indian trader, and was now on his way to Nashville, Tennessee.

Uncle Forman's keel-boat, Captain Osmun's flat-boat, and Colonel Wyckoff's small keel-boat constituted our little fleet. The day of our departure was remarkably pleasant. Our number altogether must have reached very nearly a hundred. The dinner party accompanied us to our boats, and the wharf was covered with citizens. The river was very high, and the current rapid. It was on the Monongahela where we embarked.

Our keel-boat took the lead. These boats are guided by oars, seldom used, except the steering oar, or when passing islands, as the current goes about six or seven miles an hour. As the waters were now high, the current was perhaps eight or nine miles an hour. Before daybreak next morning we made a narrow escape from destruction, from our ignorance of river navigation. We had an anchor and cable attached to our keel-boat. The cable was made fast to small posts over the forecastle, where were fenders all around the little deck. When it began to grow dark, the anchor was thrown over, in hopes of holding us fast till morning, while the other boats were to tie up to trees along the river bank.

As soon as the anchor fastened itself in the river bottom, the boat gave a little lurch or side motion, when the cable tore away all the framework around the deck, causing a great alarm. Several little black children were on the deck at the time, and as it had now become quite dark, it could not be ascertained, in the excitement of the moment, whether any of them had been thrown into the water. Fortunately none were missing. During our confusion, Captain Osmun's boat passed ours, a few minutes after the accident, and we soon passed him, he hailing us, saying that he was entangled in the top of a large tree, which had caved into the river, and

The Great Heart of the American Dominion

requested the small row-boat to assist him. Uncle Forman immediately dispatched the two mechanics, with the small boat, to his assistance. Osmun got clear of the tree without injury, and the two mechanics rowed hard, almost all night, before they overtook him. Mrs. Forman and daughters braved out our trying situation very firmly.

After we lost our anchor, Uncle Forman took a chair, and seated himself on the forecastle, like a pilot, and I took the helm. He kept watch, notifying me when to change the direction of the boat. When he cried out to me, "port your helm," it was to keep straight in the middle of the stream; if to bear to the left, he would cry out, "starboard;" if to the right, "larboard." I was not able to manage the helm alone, and had a man with me to assist in pulling as directed. Uncle Forman and I were the only ones of our party who understood sailor's terms. Ours was a perilous situation till we landed at Wheeling; it was the most distressing night I ever experienced.

Perilous river journey to Wheeling in Virginia

The next morning, all our boats landed at Wheeling, Virginia, rated at ninety-six miles from Pittsburg. Here we obtained a large steering oar for the keel-boat, as the strong current kept the rudder from acting, without the application of great strength. Having adjusted matters, we set out again. We seldom ventured to land on our journey, for fear of lurking Indians.

One day, we discovered large flocks of wild turkeys flying about in the woods on shore. The blacksmith, who was a fine, active young man, asked Uncle Forman to set him on shore, and give him a chance to kill some of them. The little boat was manned, and taking his rifle and a favorite dog, he soon landed. But he had not been long on shore, before he ran back to the river's bank, and

made signs for the boat to come and take him on board. When safely among his friends, he said that he came to a large fire, and, from appearances, he supposed a party of Indians was not far off. He, however, lost his fine dog, for he dared not call him.

We landed and stopped at Marietta, at the mouth of the Muskingum, where was a United States garrison. Some of the officers were acquainted with the family. It was a very agreeable occurrence to meet with old acquaintances in such a dreary place. The young ladies were good singers, and entertained the officers awhile with their vocal music. This night, we felt secure in sleeping away the fatigues of the journey. Governor St. Clair had his family here. There were a few other families, also; but all protected by the troops. I believe there was no other settlement until we arrived at Fort Washington, now Cincinnati, some three hundred miles below Marietta.

Life at the fort where Cincinnati now stands

A few hundred yards above Fort Washington, we landed our boats, when Uncle Forman, Colonel Wyckoff, and I went on shore, and walked up to headquarters, to pay our respects to General Harmar, the commander of our troops in the northwestern territory. The general received us with much politeness. As we were about taking leave of him, he kindly invited us to remain and take a family dinner with him, observing to Uncle, that we should have the opportunity of testing the deliciousness of what he may never have partaken before—the haunch of a fine buffalo. It being near dining hour, the invitation was, of course, accepted. As the general and lady were acquainted with Uncle and Aunt Forman in Philadelphia, they very politely extended their kindness by asking that Uncle, Aunt, and their family, together with Colonel Wyckoff

Journey in the Mississippi Valley in 1789

and Brother-in-law Scudder and Captain Osmun, would spend the next day with them, which was accepted with great pleasure. General Harmar directed where to move our little fleet, so that all should be safe under military guard. We then returned to our boats, and conveyed them down to the appointed place.

The next morning, after breakfast, and after attending to our toilets, we repaired to General Harmar's headquarters, where we were all received most cordially. Our company consisted of Mr. and Mrs. Forman, their three daughters, and Master David Forman, Miss Church, Captain Osmun, S. S. Forman, Colonel Wyckoff, and Mr. Scudder—eleven in all.

Mrs. Forman and Mrs. Harmar resembled each other as much as though they were sisters. The general invited some of his officers to share his hospitalities, also, and we had a most sumptuous dinner and tea. Before it was quite dark, we took leave of our hospitable friends. I had the honor of a seat at the table next to the general. While at dinner, the officer of the day called on General Harmar for the countersign, so as to place out the sentinels. Captain Kirby, of the army, who dined with us, was directed by the general to accompany us on our return to our boats. Just before we came to the sentinel, Captain Kirby asked us to halt, until he could advance and give the countersign, which is done with much prudence. I sauntered along, and happened to hear the challenge by the guard, and the reply of the captain. The countersign was, I believe, "Forman."

In the morning, Captain Osmun said to me, that, after paying our respects to General Harmar, he wanted me to accompany him to the quarters of the other officers, as he probably knew all of them; that they were old continental officers retained in service, and he added: "They all know your brother, Colonel Jonathan Forman, of the Revolution, and will be glad to see you on his account." We,

accordingly, after our interview with General Harmar, went to their quarters. They recollected Captain Osmun, and he introduced me, when they welcomed me most cordially, and made many inquiries after my brother.

I think it was in the autumn of 1790 that General Harmar was defeated by the Indians, and most of these brave officers were killed. At that period officers wore three-cornered hats, and by that means nearly all of them were singled out and killed, as they could be so easily distinguished from others.

Encounters with Indians along the Ohio River

Some distance above Fort Washington, the Scioto river empties into the Ohio. Near this river was a cave, which the whites had not discovered till after Harmar's defeat. Here the Indians would sally out against boats ascending the Ohio. A canoe passed us the day before we passed the Scioto, which had been fired into at that point, one man having been shot through the shoulder, another through the calf of the leg, while the third escaped unhurt. When these poor fellows arrived at Fort Washington, they waited for us. After our arrival, understanding that we were going to tarry a day, they set off. Harmar's defeat caused a French settlement near the Scioto to be broken up; some of them were killed by the Indians.

I must mention an anecdote about my friend, Captain Osmun. At the Battle of Long Island, and capture of New York by the British, many American prisoners were taken, Captain Osmun among them. He pretended to be a little acquainted with the profession of physic, but he never studied it, and could bleed, draw teeth, etc. A German officer had a very sick child, the case baffling the skill of all the English and German physicians, and the child's recovery was given up as hopeless. At last it

The Great Heart of the American Dominion

was suggested to call in the rebel doctor. So Osmun was sent for. He suppressed as well as he could his half-comical, half-quizzical expression, and assumed a serious look; felt of the child's pulse, and merely said he would prepare some pills and call again. He accordingly did so, giving the necessary directions, and promised to call at the proper time to learn the effect. When he called the third time the child had grown much better, and finally recovered. He said that all he did for the little sufferer was to administer a little powder-post, mixed up with rye-bread, made into little pills. He said he knew they could do no harm, if they did no good, and regarded himself as only an instrument in the hands of the Almighty in saving the child's life. The father of the child gave him almost a handful of guineas. Prior to this occurrence he had, while a prisoner, suffered for the necessaries of life, but thenceforward he was able to procure needful comforts till his exchange.

Sojourning in Louisville when it contained sixty houses

The next morning, after our entertainment by General Harmar and lady, we renewed our journey, floating rapidly down the Belle Riviere. Nothing of moment occurred till our arrival at Louisville, at the Falls of the Ohio. The weather now grew so severely cold, in the latter part of January, 1790, that the river became blocked with ice. Here we laid up, disembarked, and took a house in the village, the front part of which was furnished for a store, which exactly suited us, and which was gratuitously offered to Uncle Forman by a Mr. Rhea, of Tennessee. We were remarkably fortunate in this respect, both here and at Pittsburg.

Here I opened a store from our stock of goods, and took tobacco in payment, which was the object in bringing the merchandise. Louisville then contained about sixty dwell-

ing-houses. Directly opposite was Fort Jefferson, which was, I believe, only a captain's command. At the Great Miami was Judge Symmes's settlement, which dragged heavily along at that time, having been allowed only a sergeant's command for its protection.

Besides Symmes,' there was no other settlement between Cincinnati and Louisville, except that of a French gentleman named Lacassangue, a few miles above Louisville, who began a vineyard on the Indian side of the river; and one day Indians visited it, killing his people, and destroying his vines. Mr. Lacassangue was a polite, hospitable man, and gave elegant dinners.

A nephew of Mrs. Washington of the name of Dandridge lived with Mr. Lacassangue. When I returned to Philadelphia, I there met him again; he resided at General Washington's. While the Dandridge family stayed at Louisville, they received much attention. It was the custom of the citizens, when any persons of note arrived there, to get up a ball in their honor. They would choose managers; circulate a subscription paper to meet the expenses of the dance. Every signer, except strangers, must provide his partner, see her safe there and home again.

Holding a ball in Kentucky to raise funds to travel

We had scarcely got located before a subscription paper was presented to Uncle Forman and myself. But the first ball after our arrival proved a failure, owing to the inclemency of the weather, so that no ladies could attend. General Wilkinson happened in town, and though he and Uncle Forman stayed but a little while, the young blades were disposed for a frolic. Some time before this a ball was tendered to General St. Clair, when the youngsters had a row, and destroyed the most of the breakable articles that the house afforded. But

Journey in the Mississippi Valley in 1789

such instances of rudeness occurred only when no ladies were present.

Not long after the failure on account of the weather, the scheme for a dance was renewed, and, at length, we had an elegant collection of southern fair. The ball was opened by a minuet by Uncle Forman and a southern lady—Aunt Forman did not dance. This was the last time, I believe, that I saw that elegant dance performed. Then two managers went around with numbers on paper in a hat—one going to the ladies, the other to the gentlemen. When the manager calls for lady number one, the lady drawing that number stands up, and is led upon the floor, awaiting for gentleman number one, who, when called, takes his place, and is introduced by the manager to the lady. So they proceed with the drawing of couples until the floor is full for the dance.

I, in my turn, was drawn, and introduced to my dancing partner from Maryland, and we were called to the first dance. This lady happened to be acquainted with Uncle Forman's oldest son, General Thomas Marsh Forman, which circumstance rendered our casual meeting all the more agreeable. The officers of the garrison over the river generally attended, and they brought the military music along. I became well acquainted with the officers. Dr. Carmichael, of the army, used often to come over and sit in my store.

Adventures with Savages at mouth of the Cumberland

It was the last of February, I believe, when Uncle Forman and his little fleet took their departure from Louisville, destined for the Natchez country. The river was now free from ice. There subsequently came a report, that when they reached what was called the low country, below the Cumberland and Tennessee rivers, they were captured by the Indians. I was in a painful suspense for a long time, and until I heard from them.

While Uncle Forman and party were sojourning in Louisville, there was, it appears, a white man there, who learned the names of Ezekiel Forman and Captain Osmun, their place of destination, and all about them. This fellow was a decoyer, who lived among the Indians, and whose business it was to lure boats ashore for purposes of murder and robbery. At some point below the mouth of the Tennessee, this renegade saw the boats approaching, ran on the beach, imploring, upon his bended knees, that Mr. Forman, calling him by name, would come ashore and take him on board, as he had just escaped from the Indians. Mr. Forman began to steer for his relief, when Captain Osmun, who was a little way in the rear, hailed Uncle, warning him to keep in the middle of the stream, as he saw Indians in hiding behind trees along the bank where the wily decoyer was playing his treacherous part. Giving heed to this admonition, Uncle Forman kept clear of the dangerous shore.

Then an old Indian, finding that his plot was exposed, ran down to the beach, hailing the boats: "Where you go?" It is not clear what could have been the Indian's motive in making a display of himself, and seeking the information already known to his renegade associate. But for the circumstance of Captain Osmun being in the rear, and discovering the exposed Indians screened behind trees, the whole party might have been lured on shore and massacred. It seems that, after boats entered the Mississippi, they were not molested by the Indians, as they were not at war with the Spaniards.

I was left in Louisville, with a store of goods. When I had disposed of them, I was directed to join Uncle Forman at Natchez; but some considerable time was necessary to trade off my stock, and convert it into tobacco. I spent my time very pleasantly at Louisville. The southern people are remarkably friendly to

The Great Heart of the American Dominion

strangers. One family, in particular, Mr. and Mrs. Ashby, were as kind to me as though I had been their own son. They soon called on Uncle and Aunt Forman, showing all possible attention, and soon became quite familiar.

One day, Mr. Ashby called, and inquired of Aunt for "old Mr. Forman." "I tell you, Mr. Ashby," Mrs. Forman laughingly replied, "you shall not call my husband *old*. Please to refer to him as Mr. Forman, and our nephew as Mr. Sam. Forman." Mr. Ashby took the suggestion in good part, and promised ready obedience. After Uncle and Aunt Forman left for the Natchez country, Mrs. Ashby would come to my store like a mother, and inquire into the condition of my lodgings, and sent bed and bedding, and had a kind old woman examine my trunk, taking out all my clothing, first airing and then nicely replacing them, and kindly did all my washing during my stay. Mr. Ashby had a farm a little way out of town, but he and his family came in very often. Mrs. Ashby never came without making me a motherly call, and looking over my clothing to see if any repairs were needed. I never parted with briefly-made acquaintances with so much regret.

Social Life in the Wilderness and customs of the pioneers

I became every intimate with a Mr. Smith, from New York, a young gentleman about my own age. The Virginians, as were most of the Louisville people, were very fond of dancing. Smith and I agreed to let each other know when a hop was in agitation, and they were very frequent. When notified by him of one such occasion, I apologized for not being able to go, as I had no suitable pumps. "You have purchased," said he, "a parcel of elegant moccasins for your New York ladies. You don a pair and I will another." "Good! good!" we mutually ejaculated. So we en-

gaged our favorite partners, and attended the ball. It was something new to appear in such an assembly decked off in such Indian gear; but they were much admired, and, at the next dance, almost all appeared in moccasins. So, it seems, we led the town, and introduced a new fashion.

There was but one tavern and one boarding-house in the place. The boarding-house was kept by a Dr. Walter, who was also the pilot to take boats over the Falls; and he was, moreover, a great hunter and fisherman. One day in April, I think, at some public festival, several of our boarders, the leader was the Commissary of the Army, proposed to have what they called a *setting*, and asked me to join them. I had often heard the commissary relate his exploits—drinking egg-nog was then all the go. I declined to share in the frolic, fearing the influence of these southern blades on such occasions. In the course of the night, I was alarmed by the rattling of stones thrown against my store-door and window-shutters. At first, I thought it might be Indians. The clatter was kept up, and the glass windows all broken. I finally concluded that it was the work of the egg-nog party. Not only were my windows completely shattered, but my store door was broken open by the pelting of large stones.

These egg-nog disturbers served Captain Thomas, the landlord, in the same way as they had done me. The next morning, when we all met at the breakfast table at our boarding-house, scarcely a word was spoken during the meal. As I went out of the door, passing my friend, the commissary, I asked him if he would direct my windows glazed, and some little carpenter work done. He pretended to be astonished how they should have been broken. I made no reply, but walked back to my store, only looked at him and smiled. In the afternoon, at Captain Thomas's, the business assumed almost a tragical form—dirks

Journey in the Mississippi Valley in 1789

were nearly drawn; however, it was amicably settled.

The next morning these gentlemen asked me if I would be satisfied if my windows and door were made whole. I answered in the affirmative, and asked them whether they had not acted very imprudently, situated as we were on the frontiers in time of Indian warfare. "You know," said I, "that it was but a little time since that Captain Thomas and some others saw Indians in the night making, as they supposed, for my store, when I kept it up by Bear Grass creek; and a few people got together in the night, and followed the Indian trail out of the village without alarming me. The Indians evidently thought themselves discovered, and retired, hence I escaped. In consequence of this alarm, I immediately moved from that place to the center of the village, into the corner building opposite the tavern."

Experiences of a merchant on the American Frontier

It was observed one Sunday morning, soon after starting my store, that it was not opened on that day, as other establishments were; and I was asked why I kept my store closed—that Sunday had not crossed the mountains, and that I was the first person who kept his store shut on that day. I told them that I brought the Sabbath with me. It so happened that I had the honor of being the first to observe the day in Louisville.

Directly opposite to me a billiard table was kept. It was customary at the South for ladies to indulge in billiards, considering it a genteel and healthful amusement. During the morning hours, a few ladies used to honor me with a call, when I would spend a little while in that pleasant recreation; but I never gambled, and ladies' company is always more agreeable than gentlemen's. Besides, if you play with gentlemen, it is apt to lead to gambling; and it was consequently better to pay for the use of the table with ladies, when one im-

proves in manners from their refinement.

One day Captain Thomas brought a little negro boy to my store, tendering me his services while I remained in Louisville; that he should be of no expense to me, but live at home, and come over regularly and do my chores, tote water, sweep my store, clean my shoes, etc. The captain explained that he had another boy of about the same age and size, and that one was better than both. I had a spruce colored barber, who was also a tailor, the pleasure of whose company I occasionally had in helping out in my labors.

Some time about the latter part of May, perhaps, four tobacco boats arrived at Louisville on their way to New Orleans, under the respective command of Captain Andrew Bayard, Captain Winters, and Captain Gano, of New York, and Captain January, of Kentucky. Captain Bayard's boat received some injury in passing over the Falls of the Ohio, and he had to unload to repair damages. I had been some time negotiating with a rich planter, Mr. Buckner, of Louisville. After I had heard of the accident to Captain Bayard's boat, Mr. Buckner came into the village. I got him in my store, locked the door, and told him that now was the time to close our long-talked-of trade, so that I could have the company of this descending fleet. After spending the night in conversation, I gave up my bed to Mr. Buckner, and threw down some blankets and coarse clothes for my own lodging.

To make a long story short, we effected a trade—closing out my store of goods to him. He bought me a tobacco boat, loaded her with this product of the country, and got matters and things arranged so that I was ready to accompany the descending fleet. Of these tobacco traders, I was partially acquainted with Mr. Bayard. I had at Louisville a competitor in trade, a young Irish gentleman, but he could not succeed.

The Great Heart of the American Dominion

The Beginning of Commerce along the Ohio River

My boat was loaded below the Falls, and by some means the hands suffered her to break from her fastenings, and went a mile or two down stream before they brought her to. I put my blanket on board of Mr. Bayard's boat, and got on board with him, and took my tea with him. In the evening, being moonlight, my canoe, with an old sailor, came for me. I took some blankets and wrapped them around my arms carelessly. I jumped into the canoe; and the sailor, it seems, had taken a little too much whiskey, so that when he pushed off from Mr. Bayard's boat, in order to clear its bow, he leaned over so far as to make the canoe dip water; and, in recovering his position, he leaned so far the other way that the canoe filled. My arms being entangled with the blankets, I was totally helpless. Mr. Bayard's hands jumped into their small boat, came to my rescue, and saved me from a watery grave.

Partly from economy, and partly from lack of time to secure another hand, I attempted to manage my tobacco boat, which was somewhat smaller than the usual size, with less than the usual supply of boatmen. This made it come hard on me, whose unskilled strength was but half of that of an ordinary man. I had this old sailor with me for one watch, and an old northwestern man and a Jerseyman for another. The boats would follow the current, except when passing islands, when the men must all beat their oars. I believe the old sailor, while on board, was a little deranged. After I discharged him at Natchez, he was found, I was told, in the woods, dead.

Nothing of any moment occurred while descending the Ohio, until we reached Fort Massac, an old French fortification, about thirty miles above the mouth of the Ohio. It was a beautiful spot. All of the captains,

and some of the hands, with a small boat, went on shore, while our tobacco boats glided gently along. When we landed, we separated in squads, and visited the old deserted ramparts, which appeared quite fresh. It was in the afternoon, just after a refreshing shower. Those first arriving at the intrenchment, espied a fresh moccasin track. We all looked at it, and then at each other, and, without uttering a word, all faced about, and ran as fast as possible for the little boat. Some hit its locality, while others struck the river too high up, and others, too low.

Those of us who missed our way concluded, in our fright, that the Indians had cut us off; and no one had thought to take his rifle but me, and I feared that I should be the first to fall. After we were all safe on one of the tobacco boats, we recovered our speech, and each one told how he felt, and what he thought, during our flight to the boats. This locality of Fort Massac, we understood, was the direct way from the Ohio, in that country, to St. Louis, and probably the track we saw was that of some lonely Indian; and, judging from its freshness, the one who made it was as much frightened from our numbers as we were at our unexpected discovery.

I will note a little circumstance that occurred during our passage down the Ohio. One day, I was ahead of the fleet, when one of the boats passed by suddenly, when we observed by the woods that we were standing still—evidently aground, or fast on something below the surface. I gave notice to the boats behind to come on, and take position between my boat and shore, hoping, by this means, to raise a temporary swell in the river, and, by fastening a rope to my boat, and extending along beside the others, and making the other end fast to a tree on shore, be enabled to get loose.

While thus engaged, we heard a whistle, like that of a quail. Some

Journey in the Mississippi Valley in 1789

observed that quail never kept in the woods, and we felt some fear that it might be Indians; but we continued our efforts at the rope, and the boat was soon so far moved that we discovered that we were fast upon a planter—that is, the body of a tree firmly embedded in the river bottom. At last, the men could partly stand upon it, and, with a hand-saw, so weakened it that it broke off, and we were released.

Another dangerous obstruction is a tree becoming undermined and falling into the river, and the roots fastening themselves in the muddy bottom, while, by the constant action of the current, the limbs wear off, and the body keeps sawing up and down with great force, rising frequently several feet above the water, and then sinking as much below. These are called "sawyers," and often cause accidents to unsuspecting navigators.

On the Mississippi River with a fleet in 1790

When we arrived at the mouth of the Ohio, we stopped. I fastened my boat to trees, and the other boats did likewise. We kept watch, with an ax in hand, to cut the fastenings in case of a surprise by Indians. Here were marks of buffalo having rested. Where the waters of the Mississippi and Ohio mingle, they look like putting dirty soap-suds and pure water together. So we filled all our vessels that were water-tight, for fear we might suffer for want of good water on our voyage. But we found out, afterward, that the Mississippi was very good water, when filtered.

After we got all arranged, the second day after we embarked, the captains agreed that we would, in rotation, dine together, which rendered our journey more pleasant. Mr. Bayard's and my boat were frequently fastened together while descending the Ohio, but on the Mississippi, from the turbulence of the stream, it was not possible to do so. The first day that we entered the Mississippi, we

discharged all our rifles and pistols, as we were then out of danger from the hostile Indians. In the afternoon, we had a strong wind ahead, which made a heavy sea, accompanied with thunder and lightning. The waves ran so high that we felt in danger of foundering. The forward boat pulled hard for shore, which we all followed.

Presently, we saw an Indian canoe pulling for that boat. I asked my northwestern man what that meant. He looked wild, but did not know what to make of it. I directed the men to pull away, and I would keep an eye upon the suspicious visitors, and at the same time load our rifles and pistols again. Reaching the advanced boat, the Indians were kindly received, and no fighting; and, instead of hostile demonstrations, they lent a hand in rowing.

After much hard work, we at length all effected a landing in safety. We then prepared for dinner. It so happened that it was my turn to receive the captains at dinner. Having a large piece of fresh beef—enough and to spare, I invited three of our copper-faces to dine with us. Dinner over, Captain Gano set the example of *pitching the fork* into the beef, as we used, in our school days, to pitch the fork into the ground. So the Indians, one after the other, imitated the captain, and very dextrously pitched their forks also into the beef, thinking, probably, that it was a white man's ceremony that should be observed.

After dinner, at the conclusion of the pitching incident, I mixed some whiskey and water in the only glass I had, and handed it to one of the captains; and then repeating it, filling the tumbler equally alike in quantity, handed it in succession to the others. When I came to the Indians, not knowing their relative rank, I happened to present the glass to the lowest in order, as I discovered by his declining it; but when I came to the leader, he took the offering, and

The Great Heart of the American Dominion

reaching out his hand to me in a genteel and graceful manner, shook mine heartily; and then repeated the cordial shake with each of the others, not omitting his own people, and then drank our healths as politely, I imagine, as Lord Chesterfield could have fully acknowledged the compliment done. The other Indians were similarly treated, and, in turn, as grace—They all appeared much pleased with their reception.

This ceremony over, our men asked leave to visit the opposite side of the river, where these Indians had a large encampment. This granted, they all went to get their rifles. The Indians seemed to understand etiquette and politeness, and objected to the men going armed. But, instead of speaking to the men, they addressed the captains of the boats, saying: "We have no objections to your men going among our people, if they don't take their rifles. We came among you as friends, bringing no arms along." We, of course, told our men to leave their rifles behind. They did so. Returning, they reported that there were a good many Indians there. By some means, some of our men must have let the Indians have *la tafia*—a cheap variety of rum distilled from molasses. At all events, they became very much intoxicated, "and we," said the visitors, "were very apprehensive of difficulty; but a squaw told us that the Indians could not fight, as she had secreted all their knives, and we were very much relieved when morning appeared, so we could bid good-by to our new acquaintances."

Entertained by a Spanish grandee in the New America

The next day we arrived at *L' Anse a la Graisse*, which place, or adjoining it, bears the name of New Madrid, which is the American part of the little village settled under the auspices of Colonel George Morgan. Uncle Forman wrote me by all means to call at this Spanish post, as he had left my name with the genteel com-

mandant there, who would expect to see me. In the morning, after breakfast, we all prepared our toilets preparatory to paying our respects to the officer of the place. The captains did me the honor of making me the foreman of the party, as my name would be familiar to the commandant. I regret that I have forgotten his name. We made our call at as early an hour as we could, so that we might pursue our voyage without any unnecessary waste of time.

Arrived at the gate, the guard was so anxious to trade his tame raccoon with our men that he scarcely took any notice of us. We went to headquarters; there was as little ceremony. When we were shown into the commander's presence, I stepped toward him a little in advance of my friends, and announced my name. I was most cordially and familiarly received. Then I introduced my friends, mentioning their respective places of residence. After a little conversation, we rose to retire, when the commandant advanced near me, and politely asked me to dine with him an hour after twelve o'clock, and bring my accompanying friends with me. I turned to the gentlemen for their concurrence, which they gave, when we all returned to our boats.

I then observed to my friends that the commandant would expect some present from us—such was the custom—and what should it be? Mr. Bayard, I believe, asked me to suggest some thing in our power to tender. I then remarked, that, as we had a plenty of good hams, that we fill a barrel, and send them to our host; that they might prove as acceptable as anything. The proposition met the approval of all, and the hams were accordingly sent at once, with perhaps an accompanying note.

At one hour after twelve o'clock, I well remember, we found ourselves comfortably seated at the hospitable board of the Spanish commandant, who expressed much delight at receiving our fine present. He gave us

Journey in the Mississippi Valley in 1789

an elegant dinner in the Spanish style, and plenty of good wine and liquors, and coffee without cream. The commandant, addressing me, while we were indulging in the liquors before us, said that we must drink to the health of the ladies in our sweet liquors. "So," said he, "we will drink the health of the Misses Forman"—my worthy cousins, who had preceded us in a visit to this garrison.

Through the open woods with a coach-and-four to St. Louis

After dinner, the commandant invited us to take a walk in the fine prairies. He said he could drive a coach-and-four through these open woods to St. Louis. There came up a thunder-storm and sharp lightning, and he asked me what I called that in English, and I told him, when he pleasantly observed: "You learn me to talk English, and I will learn you French." Returning to headquarters, we took tea, and then got up to take our final leave. "Oh, no!" said he, "I can't spare you, gentlemen. I'm all alone. Please to come tomorrow, one hour after twelve, and dine again with me." So, at the appointed time, we were on hand again. The same kind hospitality was accorded us as on the preceding day.

In the evening, we thought we should surely tender the last farewell. But no; we must come again, for the third day, to enjoy his good company and delightful viands. That evening, there was a Spanish dance, all common people making up the company—French, Canadians, Spaniards, Americans. The belle of the room was Cherokee Katy, a beautiful little squaw, dressed in Spanish style, with a turban on her head, and decked off very handsomely. On these occasions, a king and queen were chosen to be sovereigns for the next meeting. The commandant was asked to honor them by taking a partner, and sharing in the mazy dance, which, of course, he declined; and we also had an invitation, but declined also. The com-

mandant said he always went to these happy gatherings, and sat a little while, and once, he added, he played a little while on his own violin, for his own and their amusement.

He expressed much regret at parting with us. He said he was so lonesome. He was a man not over thirty, I suppose, highly accomplished, and spoke pretty good English. I fear he was, in after years, swallowed up in the earthquake, which destroyed many; among them, I believe, a Mr. Morris, who was a brother to Mrs. Hurd; a Mr. Lintot, from Natchez, who was a passenger with me from New Orleans to Philadelphia.

On our entering the Mississippi, we had agreed that the foremost boat should fire a gun as a token for landing, if they saw a favorable spot after the middle of the afternoon. It was not possible to run in safety during the night. It so happened that every afternoon we had a thunder shower and head wind.

Nothing special occurred, I believe, till our arrival at Natchez. There was no settlement from *L'Anse à la Graisse* to *Bayou Pierre*, something like sixty miles above Natchez. At Bayou Pierre lived Colonel Bruin, of the Virginia Continental line, who, after the war, took letters from General Washington to the governor of that country while it belonged to Spain, and secured a fine land grant. I once visited Colonel Bruin, with a gentleman from Natchez. That section of country is remarkably handsome, and the soil rich. The colonel's dwelling-house was on the top of a large mound, and his barn on another, near by. These mounds are common in the Ohio and Mississippi countries, and no tradition gives their origin.

While in Louisville, I bought a young cub bear, and kept him chained in the back room of my store. He was about a month or two old when I got him; and when I went down the river, I took him along to Natchez. When twelve or fifteen months old, he

The Great Heart of the American Dominion

became very saucy; I only could keep him in subjection. When he became too troublesome, Uncle Forman had him killed, and invited several gentlemen to join him in partaking of his bear dinner.

“Drum beat to arms” when travelers stopped at Natchez

When our little fleet of five boats first came in sight of the village of Natchez, it presented quite a formidable appearance, and caused a little alarm at the fort; the drum beat to arms, but the affright soon subsided. About this time, a report circulated that General somebody, I have forgotten his name, was in Kentucky raising troops destined against that country; but it all evaporated.

Natchez was then a small place, with houses generally of a mean structure, built mostly on the low bank of the river, and on the hillside. The fort was on a handsome, commanding spot, on the elevated ground, from which was a most extensive view up the river, and over the surrounding country. The governor's house was not far from the garrison. Uncle Forman had at first hired a large house, about half-way up the hill from the landing, where he lived until he bought a plantation of five hundred acres on the bank of St. Catherine's creek, about four miles from Natchez. This he regarded as only a temporary abode, until he could become better acquainted with the country. The place had a small clearing and a log house on it, and he put up another log house to correspond with it, about fourteen feet apart, connecting them with boards, with a piazza in front of the whole. The usual term applied to such a structure was that it was “two pens and a passage.” This connecting passage made a fine hall, and altogether gave it a good and comfortable appearance.

Boards were scarce, and I do not remember of seeing any saw or grist-mills in the country. Uncle Forman

had a horse-mill, something like a cider-mill, to grind corn for family use. In range with his dwelling he built a number of negro houses, some distance off, on the bank of St. Catherine's creek. It made quite a pretty street. The little creek was extremely convenient. The negroes the first year cleared a large field for tobacco, for the cultivation of that article was the object of Mr. Forman's migration to that country.

Allotting vast plantations to settlers in Mississippi

After my arrival, and while sojourning at Natchez, Uncle Forman asked me if I intended to apply to the government for lands. I replied that I did not want any. He said he was glad of it, unless I remained in the country. He hinted something to the effect that one of the Spanish officers, who talked of leaving the country, had an elegant plantation, with negroes for its cultivation, and he thought of buying it, if I would stay and take it; that if I took land of government, and sold out, it might give umbrage to the governor, and I, being a relation, he suffer by it. I told him my father was loath to let me come away, and I promised that I would return if my life was spared me.

After this, Surveyor-General Dunbar, much to my surprise, called on me, and said that he brought the survey and map of my land, and presented a bill of sixty dollars for his services. I told him that I had not asked for land, nor had Governor Gayoso ever said anything to me about land, nor did I want any. General Dunbar replied that the governor directed him to survey for Don Samuel S. Forman eight hundred acres of land, and that it was the best and most valuable tract that he knew of in the district, including a beautiful stream of water, with a gravelly bottom—rare in that country; that it was well located, near a Mr. Ellis, at the White Cliffs, and advised me by

Journey in the Mississippi Valley in 1789

all means to take it. Uncle Forman happened to be absent, and I was in doubt what to do. At last I paid the bill and took the papers. The largest quantity that the Spanish government gave to a young man who settled in that country was two hundred and forty acres, so the governor showed much friendship by complimenting me with so large a grant.

I must go back a little, and state that my good traveling companions, Messrs. Bayard, Gano, Winters, and January, parted from me, and continued their journey down the river. Uncle Forman had been acquainted with Mr. Bayard, in Philadelphia, and their meeting in a distant and foreign country was very gratifying. The interview was very brief, for Mr. Bayard and associates were anxious to pursue their voyage.

Southern Hospitality and Aristocracy of old Louisiana

At Natchez we made many agreeable acquaintances. Governor Gayoso, a bachelor, was very affable and pleasant, and had an English education. The fort-major, Stephen Minor, was a Jerseyman from Princeton, and Mr. Hutchins, a wealthy planter, was a brother to Thomas Hutchins, the geographer-general of the United States. His wife was a Conover, from near Freehold village, and knew more about Freehold than I did. Also a Mr. Moore, a wealthy planter, Mr. Bernard Lintot, who moved from Vermont before the war, and Mr. Ellis, a wealthy planter—all having large families, sons and daughters, very genteel and accomplished. These all lived from eight to fourteen miles from us.

In the village of Natchez resided Monsieur and Madam Mansanteo—Spanish Jews, I think—who were the most kind and hospitable of people. These families, in town and country, formed our principal associates. Governor Gayoso told us, after we moved out to St. Catherine, that there would always be a plate for us at his table.

The year 1790 was a very sickly one for unacclimated persons in the Natchez country. All our family adults had more or less fever, and fever and ague. Uncle Forman was severely afflicted with gout—a lump almost as big as a small hen's egg swelled out at one of his elbows, with something of the appearance of chalk. Poor Betsey Church was taken with a fever, and died in a few days; a great loss to the family, having been a valuable and much respected member of it for many years. I was the only adult of the family who was not confined to the house with sickness.

Stephen Minor, the fort-major, married the eldest daughter of the planter, Mr. Ellis. Our family was much visited by the Spanish officers, who were very genteel men; and Major Minor was very intimate, and seemed to take much interest in us.

When the time was fixed for my departure, by the way of New Orleans, and thence by sea to Philadelphia, Uncle Forman said: "Well, you must direct Moses, the coachman, to get up the carriage, take two of your cousins with you, and take leave of all your good friends." The carriage, which had its top broken off crossing the mountains in Pennsylvania, had been fitted up in Natchez, with neat bannister work around the top of the body, which rendered it more convenient for the country. We sometimes took the family in it, and went out strawberrying over the prairies.

First four-wheeled carriage tour in Mississippi Country

Cousins Augusta and Margaret accompanied me on my farewell tour. Ours was the first four-wheeled carriage that ever passed over those grounds—I can't say roads, for the highway was only what was called a bridle-path—all traveling at that day was on horseback. When we visited one place, some of our friends from another locality meeting us there would ascertain the day we de-

The Great Heart of the American Dominion

signed visiting their house, that they might have the cane-brakes along the trail cleared away sufficient to permit the comfortable passage of the carriage; and we must, moreover, be on time, or some small gust of wind might again obstruct the passage. Our visits were all very pleasant save the unhappy part of the final bidding each other farewell.

During this excursion, Governor Gayoso had given permission for a Baptist clergyman to preach one Sunday, which was the first time a Protestant minister had been allowed to hold religious services. The meeting was held at Colonel Hutchins'. We went from the residence of some friends in that vicinity. After service we were invited to stay and dine at Colonel Hutchins'. When we were ready to depart, all came out of the house to see us off, and I asked the ladies in a jocose way to join us in the ride, when they began to climb over the wheels as though they might endanger the safety of the carriage; but this frolicsome banter over, we took our departure. We spent several days in performing this friendly round of visits—by-gone days of happiness never to return.

When I was about leaving the country, Governor Gayoso asked me what I intended to do with my land. I replied, that if I did not return in a year or two, that his excellency could do what he pleased with it. Some years after when I lived in Cazenovia, I contemplated going back, and went to my large chest, which had traveled with me from Pittsburgh to New Orleans, and thence in all my tramps and changes, where I supposed all my Spanish papers were safe in a little drawer; but, to my surprise, they were missing, and I never could tell what became of them, as I kept the chest locked, and retained the key. So vanished my eight hundred acres of valuable land in the promising Mississippi country.

On the arrival of Colonel Wyckoff, with his brother-in-law, Scudder,

from Tennessee, preparations were made for our departure. Uncle Forman went down to New Orleans with us. It was in June, 1791, I believe, that we left Natchez. The parting with my kindred was most trying and affecting, having traveled and hazarded our lives together for so many hundred miles, and never expecting to meet again in this life. Many of the poor colored people, too, came and took leave of me, with tears streaming down their cheeks. Take them altogether, they were the finest lot of servants I ever saw. They were sensible that they were all well cared for—well fed, well clothed, well housed, each family living separately, and they were treated with kindness. Captain Osmun, their overseer, was a kind-hearted man, and used them well. They had ocular proof of their happy situation when compared with their neighbor's servants. It was the custom of the country to exchange work at times; and, one day, one of our men came to me, and said: "I don't think it is right to exchange work with these planters; for I can, with ease, do more work than any two of their men;" and added, "their men pound their corn over night for their next day's supply, and they are too weak to work." Poor fellows, corn was all they had to eat.

In New Orleans before it was an American town

Uncle Forman and I stopped the first night with Mr. Ellis, at the White Cliffs, and next day embarked on board of a boat for New Orleans. On our way down we sometimes went on shore and took a bowl of chocolate for breakfast with some rich planter, a very common custom of the country. The night before our arrival at New Orleans we put up with a Catholic priest; some gentlemen of our company were well acquainted between Natchez and New Orleans, and had learned the desirable stopping places. The good priest received us kindly, gave us an excellent supper,

Journey in the Mississippi Valley in 1789

plenty of wine, and was himself very lively. We took breakfast with him the next morning; and before our departure the priest came up to me with a silver plate in his hand, on which were two fine-looking pears, which he tendered me. He looked at first very serious; but, remembering his good humor the previous evening, I suspected his fun had not yet all run out. I eyed him pretty close, and while thanking him, I rather hesitated when he urged me to take them. I knew no pears grew in that country. I finally took one, weighed it in my hand, and looked at him, till he bursted out into a loud laugh. They were ingeniously wrought out of stone or marble, and looked exactly like pears. I brought them home and gave them to a friend.

Arriving in New Orleans, we took lodgings, and our first business was to wait on his excellency, Governor Miro. Mr. Forman settling within his government with so large a number of people, under an arrangement with the Spanish ambassador at New York, Don Diego de Gardoque, gave him a high standing. Uncle Forman was in person a fine-looking man, very neat, prepossessing, and of genteel deportment, so that he was always much noticed.

On brig "Navarre" homeward bound—Off Florida and Cuba

As there was then no vessel in port destined for the United States, I had to delay a couple of weeks for one. At length the brig "Navarre," Captain McFadden, made its appearance, and soon loaded for Philadelphia. There were a number of Americans in waiting, who engaged their passage with me, on this vessel. Uncle Forman did not leave the city until after the "Navarre" had taken its departure. He suggested that I should take a formal leave of Governor Miro and his secretary, Don Andre. The secretary was a large, fine-looking

man. I politely asked him if he had any commands for the cape—Cape Francois, a fine town in the northern part of St. Domingo, usually dignified with the designation of the *The Cape*—for which port, I believe, the vessel cleared. "I know not," said the secretary, "to what cape you are going—only take good care of yourself."

After all were on board, the brig dropped down two or three miles, where the passengers went ashore, and laid in provisions, enough, the captain said, to have carried us to London after our arrival in Philadelphia. I may mention something about distances as computed in those days. From Natchez to New Orleans was called three hundred miles by water, and only one hundred and fifty by land. From New Orleans to the Balize, at the mouth of the Mississippi, was reckoned one hundred and five miles. It was said that such was the immense volume of the Mississippi river that it kept its course and muddy appearance for a league out at sea.

There were no ladies among the passengers. We entered into an arrangement that each passenger should, in rotation, act as caterer for the party for each day. It fell to my lot to lead off in this friendly service. We got along very nicely, and with a good deal of mirthful pleasure, for a couple of weeks, enjoying our viands and wine as comfortably as if at a regular boarding-house. The captain's wife, however, was something of a drawback to our enjoyment. She was a vinegary-looking creature, and as cross and saucy as her looks betokened, was low-bred, ill-tempered, and succeeded in making herself particularly disagreeable. During the pleasant weather portion of our voyage, she managed, without cause, to raise a quarrel with every passenger; and what added to her naturally embittered feeling, was that we only laughed at her folly.

The Great Heart of the American Dominion

In Philadelphia after nearly two years' travel in America

When we arrived in sight of Cuba, the wind arose, and blew almost a hurricane, causing a heavy sea. We were in such danger of being cast away on the Florida reefs that the captain summoned all hands on deck for counsel. But, providentially, we escaped. For near two weeks no cooking could be done, and each one was thankful to take whatever he could obtain in one hand, and hold fast to something with the other, such was the rolling and pitching of our frail vessel. Most of the passengers were sea-sick; I was among the few who escaped from that sickening nausea. One night the rain was so heavy, the lightning so vivid, and thunder so tremendous, that the vessel trembled at every clap; when I went to my friend Wyckoff, as well as others who were asleep, informing

them that it was a moment of no little danger and excitement.

Captain McFadden was a most profane man. But during the hours of our distress and danger he became very mild and humble, but it lasted no longer than the storm. The vinegary Mrs. McFadden, too, was very sensibly affected during this trying period; for, standing in the companion-way, leading to the cabin, she very humbly and demurely said that she would go below and make her peace. We all thought she could not be too quick about it. She was a veritable Katharine, but he was not a Petruccio.

Before we arrived at the capes of the Delaware, an American sailor, who had made his escape from a British man-of-war at the mouth of the Mississippi, sickened and died on board our craft. When we got into the Delaware, the sailors took his remains on shore and gave them a decent sepulture. At length we reached Philadelphia in safety.

VOTE TO PROSECUTE NON-CHURCH GOERS IN 1644

Record of an Election at a General Town Meeting in Salem, Massachusetts, in 1644, at which John Porter and Jacob Barney are appointed to preserve the Sabbath Day—Barney was a prominent land owner, served as selectman, and member of the General Court at Boston

Transcript from Original Record Contributed by MRS. S. L. GRIFFITH of Danby, Vermont

Voted:—"At a General Towne Meetinge held the seventh day of the fifth moneth 1644. Ordered that twoe be appointed every Lord's Day to walke forth in the time of Gods Worshippe, to take notice of such as either lye about the Meetinge House without attending to the word or ordinances, or that lye at home or in the fields without giving good account thereof and (ask) to take the names of such persons and present them to the Magistrate whereby they may be accordingly proceeded against. John Porter and Jacob Barney were the twoe appointed as watch for the eleventh day. Then to begin with Goodman Porter next the Meetinge House and so to goe through the Towne according to the order of the watch, and the first 2 give the next 2 warning of it & so from tyme to tyme."



AMERICAN INDIAN AS HE APPEARED WHEN THE WHITE MAN INVADED HIS LAND



THE RED MAN PLEADING FOR HIS RIGHTS BEFORE THE WHITE INVADER
From rare wood engravings published by William James Hamersley of Hartford, Connecticut, in 1851

Adventures in American Northwest

Life Story

of a Pioneer Fur Trader

and His Expeditions into the Remote

Parts of the New World & How American Business

Instinct Led the Way for Civilization & Accurate Transcript

from an almost Indecipherable Manuscript of Recently Discovered Journal

BY

SIR PETER POND

A FOUNDER OF THE FAMOUS NORTHWEST FUR TRUST IN 1783

THIS life story of a pioneer fur trader in the savage lands of Northwest America takes one into the confidence of a man who took a leading part in the first great trade war on the Western Continent. With his pen he carries one into the acquaintance of some of the most rugged men that the world has ever known—"men who had passed years remote from civilized society, among distant and savage tribes, and who had wonders to recount of their wide and wild peregrinations, their hunting exploits, and their perilous escapes from the Indians. These were called *coureurs de bois*, rangers of the woods; originally men who had accompanied the Indians in their hunting expeditions, and made themselves acquainted with remote tracts and tribes; and who now became, as it were, peddlers of the wilderness. Sometimes they sojourned for months among them, assimilating their tastes and habits with the happy facility of Frenchmen, adopting in some degree the Indian dress, and not infrequently taking to themselves Indian wives. Many of these *coureurs de bois* became so accustomed to the Indian mode of living, and the perfect freedom of the wilderness, that they lost all relish for civilization, and identified themselves with the savages among whom they dwelt, or could only be distinguished from them by superior aptitude for licentiousness."

As Washington Irving says: "Rivalships and jealousies ensued. Trade was injured by artifices to outbid and undermine each other. The Indians were debauched by the sale of spirituous liquors. Bloody feuds took place between rival trading parties when they happened to encounter each other in the lawless depths of the wilderness. To put an end to these sordid and ruinous contentions, several of the principal merchants entered into a partnership in the winter of 1783, which was augmented by amalgamation with a rival company in 1787. Thus was created the famous 'Northwest Company,' which held a kind of feudal sway over a vast domain of lake and forest."

"Sir" Peter Pond, from whose original manuscript now in possession of Mrs. Nathan Gillette Pond of Milford, Connecticut, this chapter is recorded, was born in that community in 1740, and became one of the creators of the famous Northwest Company, which might be called the first trust organized in the New World, and which "for a time held lordly sway over the wintry lakes and boundless forests of the Canadas almost equal to that of the East India Company over the voluptuous climes and magnificent realms of the Orient."

To preserve the individuality of the man, his keenness and observation and his quaintness as story-teller, the phonetic spelling is here maintained and the manuscript recorded as he leaves it.

Life Story of a Pioneer Fur Trader

THE ancient journal of "Sir" Peter Pond is browned with age. It is with much difficulty that the words inscribed can be made intelligible. Its opening pages tell the story of his boyhood, his experiences in the early wars in America, and of how he turned his attention to the seas, "thinking to make it my profession," in 1761. He returned from his first voyage to find that his father had gone on a trading journey to Detroit and his mother had died during the absence. He was obliged to give up the idea of going to sea, and settled down at home to take charge of a young family of brothers and sisters until his father returned. This occupied three years and he relates that it was the only three years of his life that he was in one place from the time he was sixteen years of age to sixty.

The first years of his adventures in the Great Northwest are here related in his own words:

At ye End of the three years I went into trade first at Detroit. I Continued in trade for Six years in Differant Parts of that Countrey But Beaing Exposed to all Sorts of Company. . It Hapend that a parson who was in trade himself to Abuse me in a Shamefull manner Knowing that if I Resented he Could shake me in Peaces at same time supposing that I Dare not Sea him at the Pints or at Leas I would not But the Abuse was too Grate. We met the Next Morning Earley & Dischargd Pistels in which the Pore fellowe was unfortenat. I then Came Down the Countrey & Declard the fact But thare was none to Pros-acute me.

I then Made a ture to ye West Indees & on my Return Home I Received a Letter from a Gentleman in New York to Com Down and Sea him for he was Desiras to Go into Partner Ship with me in trade. I Complyde and we Lade in a cargo to the amount of four thousand Six Hundred Pounds & I went In to the Entearer Part of the Countrey first to Mishlemackanack from thenst to the Mississippay and up Sant Peters River & into the Plains Betwene the Mississippay & the Miseurea and Past my Winter among the Nattawaysease on such food as thay made yous of themselves which was Verey darteyaly Cooked.

The Next is to Show the Way of Convance of these Goods to the Most Remot Parts of ye Countrey for that Year or Season. In the first Plase thay ware Shipt at New York for allbaney—from thens thay ware taken fourteen Miles By Land to Sconacaday in wagons—then Shipt on Bord Battoes & taken up the Mohawk River to fort Stanwix—thare Carread a Mile By Land with the Boates and Put in to Woodcrick & from thens threw the Onida Lake & Down those waters to Lake Ontarey & Coasted along the South Side of that Lake till thay came to Nagarey & from the Landing Plase a few Miles South of that fort thay warewith the Battoes Caread a Cross that Caring Place about Nine Miles—then Put in to the Waters that Com out of Lake Erey into Lake Ontarey at a Plase Cald Fort Slosser—from that the boats ware taken to a small fort Cald fort Erey in the North Side of Lake Erey—then Coasting along South Side of that Lake til thay Com to the Mouth of that River—then up to Detroit—from thens up those waters to Lake St. Clair a small one about fourteen Miles Long—from thens Pros these waters which Com out of Lake Huron you come to that Lake and Coasting a Long the West Sid of it about five Hundred Miles thay Cam to Mishlamacknack that Lay on that. On the South Side of a Strate Betwene Lake Huron & Mishagan thare was a British Garason whare all the traders asembled yearley to arang thare afares for the In-sewing Winter But I Did not Acompany my Goods myself—Left that Part to my Partner Mr. Graham. I wanted Som Small artickels in the Indian way to Compleat my asortment which was not to be had in New York. I thare foure

Adventures in the American Northwest

took my Boate threw Lake George & threw Lake Champlain to Montreal whare I found all I wanted. This was in the Spring 1773. Thare was a number of Canoes fited for Mishlemacanac. I agreed With Isac Tod a Sgr to take my Goods in his Canoe on freight and Imbarkt with him & James McGill Esq. in one of his Canoes and Seat of from Lashean for Mackinac By way of the Grand River. As you Pass the End of the Island of Montreal to Go in a Small Lake Cald the Lake of the . . . Mountains thare Stans a Small Roman Church Aganst a Small Raped. This Church is Dedacated to St. Ann who Protects all Voigers. Heare is a small Box with a Hole in the top for ye Reseption of a little Money for the Hole father or to say a small Mass for those Who Put a small Sum in the Box. Scars a Voiger but stops hear and Puts in his mite and By that Meanes thay Suppose thay are Protected. While absent the Church is not Locked But the Money Box is well Secured from theaves. After the Sarmony of Crossing them selves and Repeating a Short Prayer we Crost the Lake and Entered the Grand River so Cald which Lead us to the Waters which Coms in to that River from the Southwest. We ascended these waters & Making Som Careing Places we Came to a Small Lake Cald Nipasank whose Waters fall into Lake Huron By the french River. We Desended that River and Coasted along the North Side of that Lake til we Came Oppseat to Mackenac—then Crost the Streat to the Garrasson whare I found my Goods from New York Had Arived Safe. Hear I Met with a Grate meny Hundred People of all Denominations—Sum trading with the tribes that Came a Grate Distans with thare furs, Skins & Mapel Suga &c to Market. To these May be added Dride Venson, Bares Greas, and the Like which is a Considerable Part of trade. Others ware Imployd in Making up thare Equipments for to Send in to the Different Parts of the Country to Pas the Winter with ye Indan tribes and trade what thay Git from the Hunt of ye Winter Insewing. I was one of this Discription. I Divided my Goods into twelve Parts and fited out twelve Larg Canoes for Differant Part of the Mississippi River. Each cannew was mad of Birch Bark and white Leader thay would Carry seven Thousand wate.

A Description of Macenac—This Place is Kept up by a Cpts. Command of British which were Lodged in Good Barracks within the Stockades whare thare is Som french Bildings & a Commodious Roman Church whare the french inhabitants & Ingasheas Go to Mass. Befoar it was given up to the British thare was a french Missenare astablished hear who Resided for a number of years hear. While I was hear thare was None But traveling One who Coms sometimes to mak a Short stay But all way in the Spring when the People ware ye Most numeras then the Engashea often went to Confes & git absolution. I had the next winter with me one who was Adicted to theaving—he took from me in silver trinkets to the amount of ten Pound But I got them agane to a trifle. In the spring we found one of those Preasts at Mackenac who was Duing wonders among the People. My young Man Babtist who had Comited the theft Heard of it from his Comrads who Had Bin to Confess. His Consans smit him & He Seat of to Confess but Could Not Git absolution. He went a seacond time without sucksess But was Informed by his Bennadict that Something was wanting. He Came to me Desireing me to leat him Have Two Otter Skins Promising that He Would Be Beatter in futer and sarve well. I Leat Him have them. He went of. In a few Minnets after or a Short time he Returned. I askt him What Suckses. O sade he the farther sais my Case is a Bad One But if I Bring two Otter more he will take my Case on himself and Discharge me. I let him Have them & in a short time he Returned as full of thanks as he Could Expres and sarved me well after. The Inhabitans of this Plase trade with the Natives and thay Go out with ye Indians in the fall and winter with them—Men, woman and Children. Most of the french-

Life Story of a Pioneer Fur Trader

mens wives are white women. In the Spring they make a Grate Quantity of Maple Suga for the youse of thare families & for sale som of them. The Land about Macinac is Vary Baran—a Mear Sand Bank—but the Gareson By Manure Have Good Potaters and Sum Vegetables. The British Cut Hay anuf for thare Stock a few Miles Distans from the Gareson & Bring hom on Boates. Others Cut the Gras & Stock it on the Streat & Slead it on the Ice Thirty Miles in ye Winter. Thare is Sum Indan Villeges twenty or thirty Miles from this Plase whare the Natives Improve Verey Good Ground. They Have Corn Beens and meny articles which they youse in Part themselves and Bring the Remander to Market. The Nearest tribe is the Atawase & the most Sivelized in these Parts But Drink to Exses. Often in the Winter they Go out on a Hunting Party. In ye Spring they Return to thare Villeges & Employ the Sumer in Rasein things for food as yousal. But this is to Be understood to Belong to the Women—the men Never Meadel—this Part of thare bisness is Confind to the females Ondley. Men are Employd in Hunting, fishing & fouling, War Parties etc. These Wood aford Partreages, Hairs, Vensen foxis & Rackcones, Sum Wild Pigin. This Lake or Strate abounds in all sorts of fine fish. I have Wade a trout taken in By Mr. Camps with a Hook & line under the Ice in March Sixtey Six Pounds wate. I was Present. The Water was fifteen fatham Deape. The white fish are ye Another Exquisiteat fish. They will way from 2½ to 9 & 10 Pound wt. Baran La Huntan who was the first that made an Excirion from Macanac Into the Masepey By the Rout of thee Fou River—tho his Ideas ware Rong in Som things as I have Proved Sins his day—that the flame of white fish was Might the Sturges are the Best in these Lakes & the Harens Exsead in flaver. The waters are trans Parant and fine.

I return to my one. In Sept I Had my Small fleat Readey to Cross Lake Mishegan. On my Way to Grean Bay at the Mouth of fox river I Engaged Nine Clarkes for Differant Parts of the Northan & Westarn Countrey and Beaing Mand we Imbarkt & Crost the Lake yithout Seaing an Indan or Eney Person Except our One. In three or four Days we arive at the Mouth of the Bay which is two or three Mile Brod. In the Mouth is Som Islands which we follow in Crossing to the South West Sid & then follow ye Shore to the Bottom is Seventey Miles whare the fox River Empteys in to the Bay. We went a Short Distans up the River whare is a small french village and thare Incampt for two Days. This Land is Exalant. The Inhabitans Rase fine Corn and Sum Artickels for fammaley youse in thare Gardens. They Have Sum trad with ye Indans which Pas that way. On the North Part of this Bay is a small Villegag of Indans Cald the Mannomaneas who Live By Hunting Cheafly. They have another Resois—the Bottom of the Bay Produces a Large Quantity of Wilde Rice which they Geather in Sept for food. I ort to have Menshand that the french at ye Villeg whare we Incampt Rase fine black Cattel & Horses with Sum swine.

At the End of two Days we ascended the fox river til We came to a Villeg which Lies on the East End of a small Lake that Emties into the fox River. These People are Cald Penans & the Lake by the same Name. These People are Singelar from the Rest of thare Neighbors. They Speake a Hard Un Couth Langwidge scarst to be Learnt by Eney People. They will not a Sosheat with or Convars with the other tribes Nor Inter-marey among them. I Enquired into the Natral Histrey of these People when I was at Detroit of the Oldest and Most Entelagent frenchmen Who had Bin aquanted with them. for Meney Years. The Information amounted to this that thay formerley Lived West of ye Misararey River—that thay Had Eternal Disputes among themselves and Dispute with the Nations about them—at Length thare Neigh-

Adventures in the American Northwest

bors In Grate Numbers fel upon them and what was Saved flead across the Misesarea to ye eastward and Over the Mississippey and on to this Lake whare thay now live thare thay met with a trib of Indans Who Suferd them to Seat Down. It was as is Suposed the foxe Nation who lived Near them—the fox-is was Drove from Detroit for thare Misbehavior which ware a proper People to aSist them in thare flite. I Beleve most of it. They are Insolent to this Day and Inclineing Cheaterey thay will if they Can Git Creadit from the trader in the fall of ye Year to Pay in the Spring after they Have Made thare Hunt But When you Mete them in Spring as Know them Personeley ask for your Pay and thay Will Speake in thare One Languege if thay Speake at all Which is not to be understood or Other ways thay Will Look Sulkey and Make you no answer and you loes your Debt.

I was at Mackenac when Capt George Turnbull Comanded Previous to the Amarecan Revelution and thare Came in a Cheaf with a Small Band of these. He Held a Counsel with them But he Couldn't Git an Intarpetar in the Plase that Understood them. At Lengh the Capt Said that he had a mind to Send for an Old Highland solge that Spoke Little But the Hars Langwege—Perhaps he mite understand for it Sounded Much Like it. The Land about them on the Lake is Exalant. Thare women Rase Corn & Beens Punkins &c But the Lake afords no Variety of fish thare Wood Produce Sum Rabits & Partreageis, a small Quantaty of Vensen. Thay Live in a Close Connection among themselves. We made But a Small Stay Hear and Past a Small Distans on the Lake and Entered the fox River agane Which Leads up to the Cairing Plase of Osconston.

Adventure into Indian Camp during Burial Ceremony

We asended that River til we Cam to a High Pece of Ground whare that Nation yous to Entan thare Dead when thay Lived in that Part. We stopt hear awhile finding Sum of that Nation on the Spot Who Came thare to Pay thare Respect to thare Departed frend. Thay Had a small Cag of Rum and sat around the grave. Thay fld thar Callemeat and Began thar saremony By Pinting the Stem of the Pipe upward—then giveing it a turn in thare and then toward ye head of the Grav—then East & West, North & South after which thay smoaked it out and fld it agane & Lade By—then thay took Sum Rum out of the Cag in a Small Bark Vessel and Pourd it on the Head of the Grave By way of giving it to thar Departed Brother—then thay all Drank themselves—Lit the Pipe and seamed to Enjoi themselves Verey well. Thay Repeated this till the Sperit Began to Operate and thare harts Began to Soffen. Then thay Began to Sing a Song or two But at the End of Every Song thay Soffened the Clay. After Sumtime Had Relapst the Cag had Bin Blead often. Thay Began to Repete the Satisfaction thay had with that friend while he was with them and How fond he was of his frends While he Could Git a Cag of Rum and how thay youst to Injoy it togather. They Amused themselves in this manner til thay all fell a Crying and a woful Nois thay Mad for a While til thay thought Wisely that thay Could Not Bring him Back and it would Not Due to Greeve two much—that an application to the Cag was the Best Way to Dround Sorrow & Wash away Greefe for the Moshun was soon Put in Execution and all Bega to be Marey as a Party Could Bea. Thay Continued til Near Nite. Rite Wen thay Ware More than Half Drunk the men began to aproach the females and Chat frelay and apearantley friendly. At rought thay Began to Lean on Each other, Kis & apeared Verey amaras. I Could Observe Clearly this Business was first Pusht on by the Women who made thare visit to the Dead a Verey pleasing one in thare Way. One of them who was Quit Drunk, as I was By Self Seating on the Ground observing thare Saremones, Cam to me and askt me to take a Share in her Bountey

Life Story of a Pioneer Fur Trader

. . . . But I thought it was time to Quit and went about Half a mile up the River to my Canoes whare My men was Incamp But the Indans never cam Nigh us. The men then shun that three of the Women had bin at the Camp In the Night In Quest of Imploy. The next Morning we Proseaded up the River which was Verey Sarpentine inded til we Cam to a Shallo Lake whare you Could Sea water But Just in the Canoe track the Wilde Oates ware so thick that the Indans Could Scarse Git one of thare Small Canoes into it to Geather it and the Wild Ducks When thay Ris Made a Nois like thunder. We Got as meny of them as we Chose fat and Good. We Incamp hear Would not undertake to Cross til Morning—the Water was two Deap to wade and ye Bottom Soft—the Rode so narrow that it toock the Most of ye next Day to get about three Miles With our Large Cannoes the track was so narrow. Near Nite we Got to Warm Ground whare we Incamp and Regaled Well after the fateages of the Day. The Next Day we Proseaded up the River which was slack water But Verey Sarpentine—we Have to go two Miles Without Geating fifty yards ahead so winding—But Just at nite we reacht within Site of ye Caring Plase and Incamp. Next morning Near noon we Arived and unLoded our Canoes & toock them out of the water to dry that thay mite be liter. On the Caring Plase On account of the fox River and its Nighbing Cuntrey A Long its Shores from the Mouth to the Pewans Lake is A good Navagation. One or two Small Rapeds from that Lake the water up to the Caring plase is Verey Gental But Verey Sarpentine. In Maney Parts In Going three Miles you due not advans one. The Bank is almose Leavel With the Water and the Medoes on Each Sid are Clear of Wood to a Grate Distans and Clothd with a Good sort of Grass the Opeings of this River are Cald Lakes But thay are no more than Larg Openings. In these Plases the Water is about four or five feet deap. With a Soft Bottom these Places Produce the Gratest Quantaties of Wild Rise of Which the Natives Geather Grat Quantities and Eat what thay Have Ocation for & Dispose of the Remainder to People that Pass & Repass on thare trade. This Grane Looks in its Groth & Stock & Ears Like Ry and the Grane is of the same Culler But Longer and Slimer. When it is Cleaned fit for youse thay Baile it as we Due Rise and Eat it with Bairs Greas and Suger But the Greas thay ad as it is Bileing which helps to Soffen it and make it Brake in the same Maner as Rise. When thay take it out of thare Cettels for yous thay ad a Little suger and is Eaten with fresh Vensen or fowls we yoused it in the Room of Rise and it Did very well as a Substatute for that Grane as it Busts it turns out perfectly White as Rise. Back from this River the Lands are as Good as Can be Conseaved and Good timber But not Overthick it is Proverbel that the fires Which Ran threw these and Meadows Stops the Groth of ye Wood and Destroise Small wood. I Have Menshund the Vast Numbers of Wild Ducks which faten on ye Wild Rise Eaverey fall. It would Sound two much Like a travelers Storey to Say What I Realey Beleve from What I Have Sean. You Can Purchis them Verey Cheape at the Rate of two Pens Per pese. If you Parfer shuting them yourself you may Kill what you Plese. On account of the Portage of Wisconstan the South End of this Caring plase is Verey Leavel But in Wet Weather it is Bad On acount of the Mud & Water which is two thirds of a Mile and then the Ground Riseis to a Considerabel Hith and Clothed with fine Open Wood & a Hansom Varder.

A French Deserter's Experience in the Wilderness

This Spot is about the Senter of ye Portage and takes up about a Quarter Part of it. The South End is Low, flat and Subject to Weat. It was on this Spot that Old Pinnashon a french man Impose upon Came Respecting the Indans haveing a Rattel snake at his call which the Indans Could order into a

Adventures in the American Northwest

Box for that Purpos as a Peat. This frenchman was a Soldier in the troops that ware stasioned at the Elenoas. He was a Sentanal. At the Magasean of Powder he Deserted his Post & toock his Boate up the Miseura among the Indans and Spent Maney years among them. He Learnt Maney Langwedgeis and from Steap to Steap he Got among the Mondons whare he found Sum french traders who Belongd to the french factorye at fort Lorain on the Read River. This factorye Belongd to the french traders of Cannaday. These People toock Pinneshon to the factorye with them and the Consarn toock him into thare Sarvais til the Hole Cuntrey was Given up to the English and he then Came into thare Sarvis. The french Strove to take him up for his Desarson But fald. However thay Orderd him to be Hung in Efacea Which was Dun. This is the Account he Gives of himself. I Have Hard it from his One Lips as he has Bin Relateing his adventures to others. He found Carner on this Spot Going without undirstanding either french or Indan & full of Enquirey threw his Man who Sarved him as an Interpiar & thought it a Proper Operuntety to ad Sumthing more to his adventers and Make his Bost of it after which I have Haird Meney times it hurt Caiver much hearing such things & Puting Confadens in them while he is Govner. He Gave a Good a Count of the Small Part of the Western Countrey he Saw But when he a Leudes to Hearsase he flies from facts in two Maney Instances.

After Two Days Hard Labor We Gits our Canoes at the Carring plase with all our Goods and Incampt on the Bank of the River Wisconstan and Gund our Canoes fit to descend that River. About Midday we Imbarkt. The River is a Gentel Glideing Streame and a Considerabell Distans to the first Villeag which Lise on the North Side. The River runs near west from the Portage to the Missippey. Its a Gentel Glideing Streame. As we Desended it we saw Maney Rattel Snakes Swimming Across it and Kild them. The Next Day we Arived at the Villeag whare we tarread two Days. This Beaing the Last Part of Sept these People had Eavery artickel of Eating in thare way in abandans. I shall Give Sum acount of these People and the Countrey. These People are Cald Sankeas. Thay are of a Good Sise and Well Disposed—Les Inclind to tricks and Bad manners than thare Nighbers. They will take of the traders Goods on Creadit in the fall for thare youse. In Winter and Except for Axedant thay Pay the Deapt Verey Well for Indans I mite have sade Inlitend or Sivelised Indans which are in General made worse by the Operation. Thare Villeag is Bilt Cheafely with Plank thay Hugh Out of Wood—that is ye uprite—the top is Larch Over with Strong Sapplins Sufficient to Suport the Roof and Covered with Barks which Makes them a tile roof. Sum of thare Huts are Sixtety feet Long and Contanes Several fammalayes. Thay Rase a Platfoarm on Each Side of thare Huts About two feet high and about five feet Broad on which thay Seat & Sleap. Thay have no flores But Bild thar fire on the Ground in the Midel of the Hut and have a Hole threw the Ruf for the Smoke to Pas. In the fall of ye Year thay Leave thare Huts and Go into the Woods in Quest of Game and Return in the Spring to thare Huts before Planting time. The Women Rase Grate Crops of Corn, Been, Punkens, Potatoes, Millans and artickels—the Land is Exaleant—& Clear of Wood Sum Distans from the Villeag. Thare Sum Hundred of Inhabitants. Thare amusements are Singing, Dancing, Smokeing, Matcheis, Gameing, Feasting, Drinking. Playing the Slite of Hand, Hunting and thay are famas in Mageack. They are Not Verey Gellas of thare Women. In General the Women find Meanes to Grattafy them Selves without Consent of the Men. The Men often join War parties with other Nations and Go aganst the Indans on the Miseure & west of that. Sometimes thay Go Near St. Fee in New Mexico and Bring with them Spanish Horseis. I have sean meney of them. The River aford But a few

Life Story of a Pioneer Fur Trader

fish. Thare Woods aford Partridgeis, a few Rabeat, Bairs & Deear are Plenty In thare Seasons. Wild fowl thay have But few. Thar Religion is Like Most of the tribes. Thay alow thare is two Sperits—One Good Who Dweles a Bove the Clouds, Superintends over all and helps to all the Good things we have and Can Bring Sickness on us if He pleases—and another Bad one who dweles in the fire ad air, Eavery whare among men & Sumtimes Dose Mischchef to Mankind.

Courtship and Marriage among the Indians

Cortship & Marriages—At Night when these People are Seating Round thare fires the Elderly one will be teling what thay Have Sean and Heard or Perhaps thay may be on Sum Interesting Subject. The family are lising. If thare be aney Young Garl in this Lodg or hut that aney Man of a Differant Hut Has a Likeing for he will Seat among them. The Parson of his Arrant Being Prasant hea will Watch an Opertunety & through a Small Stick at Hair. If She Looks up with a Smile it is a Good Ornen. He Repets a Second time. Perhaps ye Garle will Return the Stick. The Sentam ar Still Groing Stronger and when thay think Proper to Ly Down to Slepe Each Parson Raps himself up in his One Blanket. He takes Notis whar the Garl Seats for thare she sleses. When all the famaley are Quit a Perhaps a Sleap he Slips Soffely into that and Seat himself Down By her Side. PresantLey he will Begin to Lift Her Blanket in a Soft maner. Perhaps she may twich it Out of his hand with a Sort of a Sie & Snore to Gather But this is no Kiling Matter. He Seats awhile and Makes a Second Atempt. She May Perhaps Hold the Blankead Down Slitely. At Lengh she turns Over with a Sith and Quits the Hold of the Blanket. This Meatherd is Practest a Short time and then ye young Indan will Go ahunting and he is Luckey to Git meat he Cum and Informs the famaley of it and where it is he Brings the Lung and hart with him and thay Seat of after the Meat and Bring it Home this Plesis and he Begins to Gro Bold in the famerley. The Garl after that will not Refuse him He Will then Perhaps Stay about the famerley a Year and Hunt for the Old father But in this Instans he gives his Conseant that thay may Sleap together and when thay Begin to have Children thay save what thay can git for thare One youse and Perhaps Live in a Hut apart. After I had Given them a number of Cradeat to Receve Payment the Next Spring I Densed to the fox Villeage on the Same River and Same Sid about fitey Miles Distans. Hear I meat a differant Sort of People who was Bread at Detroit under the french Government and Clarge; till thay By Chrisanising Grew so Bad thay ware Oblige to Go to War aganst them. Tho thay Lived Within thre Miles of the Garrson and among the Inhabatans, thay Was Obliged to fite them and killed Grate Numbers of them. The Remander flead to the fox River whare thay made a Stand and treated the traders Going to the Missasseepey Verey Ill and Pilleaged them. At Lengh thay went a Stronge Partey aganst them and Beat them back to whare thay Now are But in Sad Sarkamstanis to what thay ware Before thay took So much on them selves. As I Aprocht the Banks of the Villeag I Perseaved a Number of Long Panted Poles on which Hung a Number of Artickels, Sum Panted Dogs and also a Grate Number of Wampam Belts with a Number of Silver Braslets and Other Artickels in the Indan way. I Inquired the Cause. Thay told me thay Had a Shorte time Before had a Sweapeing Sicknes among them which had Caread of Grate Numbers of Inhabitans & thay had offered up these Sacrafisces to Apease that Beaing who was Angrey with them and sent the Sickness—that it was much Abated tho thar was Sum Sick. Still I told them thay Had Dun Right and to take Cair that thay Did not Ofend him Agane for fear a Grater

Adventures in the American Northwest

Eavel myte befall them. Thare Villeag was Bilt in the Sam form & ye the sam Like Materls as the Sankeas Produse of the Ground—the Sam & Brote in the Same By the Women But not in so Grate Plentey as the former one on Account of thare Late sickness. I taread hear One Day.

After Suplying myself with such Artickels as I wanted and thay Had to Spare I gave them Sum Creadeat and Desended the River to the Mouth which Empteys into the Masseppey and Cros that River and Incampt. The Land along the River as ye desend Apears to be Exalant. Just at Night as we ware Incampt we Perseaved Large fish Cuming on the Sarfes of the Water. I had then a Diferant trader with me who had a number of Men with him. We were Incampt Near Each other. We Put our Hooock and Lines into the Water and Leat them Ly all nite. In the Morning we Perseaved thare was fish at the Hooocks and went to the Wattr Eag and halld on our line. Thay Came Heavey. At Lengh we hald one ashore that wade a Hundered and four Pounds—a Seacord that was One Hundered Wate—a third of Seventy five Pounds. The Men was Glad to Sea this for thay Had not Eat mete for Sum Days nor fish for a long time. We asked our men How meny Men the Largest would Give a Meale. Sum of the Largest Eaters Sade twelve men Would Eat it at a Meal. We Agread to Give ye fish if thay would find twelve men that would undertake it. Thay Began to Dres it. The fish was what was Cald the Cat fish. It had a large flat Head Sixteen Inches Betwene the Eise. Thay Skind it—Cut it up in three larg Coppers Such as we have for the Youse of our men. After it was Well Boild thay Sawd it up and all Got Round it. Thay Began and Eat the hole without the least thing with it But Salt and Sum of them Drank of the Licker it was Boild in. The Other two was Sarved out to the Remainder of the People who finished them in a Short time. Thay all Declard they felt the Beater of thare Meale Nor did I Perseave that Eney of them ware Sick or Complaind. Nxt Morning we Recrost ye River which was about a Mile Brod and Mounted about three Miles til we Come to the Planes of the Dogs so Cald the Grate Plase of Rondavues for the traders and Indans Before thay Dispars for thare Wintering Grounds. Hear we Meat a Larg Number of french and Indans Makeing out thare arangements for the InSewing winter and sending of thare cannoes to Differant Parts—Like wise Giveing Creadets to the Indans who ware all to Rondaveuse thare in Spring. I Stayed ten days Sending of my men to Differant Parts. I had Nine Clarks which I Imploid in Differant Rivers that fel into the River.

When I had finished my Matters Hear in October I Seat of with two traders in Company for St. Peters River which was a Hundred Leags up the River But the Season was faverabel and we went on Sloley to Leat the Nottawaseas Git into the Plain that we Mite not be trubeld with them for Creadit as thay are Bad Pay Marsters. In Going up the River we had Plenty of fat Gease and Duks with Venson—Bares Meat in abandans—so that we Lived as Well as hart Could Wish on Such food—Plentey of flower tea, Coffee, Sugar and Buter, Sperits and Wine, that we faird Well as Voigers. The Banks of ye River aforded us Plentey of Crab Apels which was Verey Good when the frost Had tuchd them at a Sutabel tim.

SONNET BY HORACE HOLLEY

Alas for all old cities of the dead;
(God send the bitter vision oft to me!)
Troy much-sung and Venice on the sea;
Nineveh and Rome—all, all are sped.
Their night came not with any sudden dread
Of ghastly war or grinding tyranny:—
With sword in hand men wax more strong to be,

And heroes rise in towns beleaguered:—
But twilight slowly drew her blanket down
When none had aught of dawn left in his eyes,
For poets had sold their sorrow for a fee
And maids had ceased to dream of love's sweet sighs.
Oh ye that keep the rule of Modern Town,
God send this vision oft to you and me.

ESTATE OF A PROSPEROUS AMERICAN IN 1684

"INVENTORY OF LEWIS JONES, LATELY DECEASED, OF GOODS AND CHATELL TAKEN BY US WHOSE NAMES ARE UNDER WRITTEN THIS 20TH DAY OF APRIL 1684".

TRANSCRIBED FROM ORIGINAL BY

WALTER E. JONES OF WAITSFIELD, VERMONT

A DESCENDANT OF THE LEGATOR

	£	s	d
The housing and land.....	.035	00	00
A cow and heifer.....	.004	05	00
Wearing Cloaths.....	.001	10	00
In ye lodging Room			
One feather bed, two pillows, one bolster, one rug, three old blankets, three sheets, curtains and bed stead.....	.05	00	00
One small flock bed, one coverlett, one bolster, two pillows, two sheets, one old straw bed, two blankets and a Trundle bed stead.....	.002	04	00
One Chest, one Tablecloth, one napkin, with some other old linnen, one small box, one forme.....	.000	12	00
In ye fire Room			
One brass Kettle, two skillets, one old warming pan.....	.000	17	00
Three small pewter dishes, one quart pot, one frying pan.....	.001	10	00
Three irons potts and 2 pr of pot hooks, one frying pan.....	.001	10	00
In Books.....	.001	15	00
One Tramell, one fire shovel, a pr. of Tongs, one spitt, a pr. of Bellows, with other small things.....	.000	12	00
Two Tables, one Chest, a kneading Trough and 2 old chairs.....	.000	16	00
One halfe bushell, a baskett, 1 pail.....	.000	16	00
One beetle and wedges, one ax two pitch forks with some old Iron and other lumber.....	.000	10	00
In earthen ware with two bags.....	.000	04	00
Upon ye chamber			
One old fan, one flock bolster, one old Caske (sic) & lumber.....	.000	10	00
In rye and malt.....	.000	18	00
In barley.....	.000	14	00
In Indian Corn.....	.003	10	00
In ye cellar			
One powdering Tub, four barrells, one old churne, one small caske, two Earthan potts and one Keeler and other lumber.....	.000	19	00
			Total £ 062 02 00

JOHN COOLIDGE }
 JOHN BRIGHT } Apr 2 1684
 MANNING SAWIN }

JOSIAH JONES Administrator took oath in court hereto

First Silhouettists in America

Earliest Extant Type of Pictoriology & Brown's Notable
Collection of Portraits of Distinguished Americans

BY

HOWARD MARSHALL

WITH REPRODUCTIONS FROM BROWN'S ORIGINAL SILHOUETTES

THE first American photographer was the silhouettist, and the early Americans, with all the strength and weakness of human nature, went to him for their portraiture, much as the modern American sits before the camera to-day. The earliest extant type of pictoriology, found upon the Egyptian mummy-cases and Etruscan pottery, is the silhouette. It passed down the generations until Madam Pompadour, a woman of French society, had her profile made in black upon a white ground by simply casting a shadow with a lamp, and it immediately became the fashion throughout France to have one's profile "à la Pompadour."

It was about this time that Etienne de Silhouette, financial minister of Louis XV, inaugurated his rigid system of economy which came so near to parsimony that his name was used as an appellation for everything cheap or shabby. The plain black profiles were so inexpensive and so common among all classes of people that the aristocracy finally exclaimed in disdain: "It's too Silhouette."

The first silhouettist to begin business in America was Charles Wilson Peale in Philadelphia, more than a century ago, and here American society gathered to sit for portraits. The distinguished men of the day also patronized Peale and one of the most famous of his silhouettes is that of George Washington.

One of the most noted silhouettists to come to America was James Hubbard, an English youth of seventeen

years, who landed in New York under special "management" a few days after the arrival of Lafayette in 1824. He was made the subject of much comment in the newspapers and traveled about the country exhibiting his "Hubard Gallery" in which for fifty cents the visitor was "entitled to see the exhibition, hear the concert, and obtain a correct likeness by Master Hubard, cut with common scissors in a few seconds, without the aid of drawing or machine."

So lucrative seemed the "new profession" that many men entered it, not only profiting financially but also making the acquaintance of the exclusive families of the period. One of these was William Henry Brown, who was born in Charleston, South Carolina, May 22, 1808, and became a genius in the quaint art of portraiture. In his travels through the principal cities of the United States he cut the silhouettes of the most eminent citizens. So adept did he become that with a single glance of the eye he could photograph on his memory the profile and figure of an object and reproduce it months or even years afterwards with absolute accuracy. He was brilliant in conversation and his fund of reminiscences of prominent men gave him entrée into the first homes of America. Brown accumulated money rapidly and spent it lavishly, but at the close of his career left a remarkable collection of silhouettes of many distinguished Americans. On the following pages four of the most characteristic silhouettes are reproduced from the collection in the Brown "Portrait Gallery."

Portrait Gallery of Famous Americans



SILHOUETTE of Daniel Webster taken in the zenith of his greatness in the United States Senate, when he was about fifty-seven years of age. Webster was

much pleased with this portrait and wrote to Brown, the silhouettist: "My friends unite in saying that the one you took of myself is a striking likeness. I cannot, however, see its resemblance to the original, as I do in all the others. It is an old and very true saying 'that if we could see ourselves as others see us,' etc." Brown in his notes gives these impressions of Webster: "He is rather above the ordinary stature. His forehead high and broad, resting as it were upon a lowering brow, is striking and peculiar. His eyes are dark and deep-set, his lips rather thin and generally compressed. His whole countenance is grave, and marked with the impress of dignity and close thought. His hair is black and his complexion rather dark. To strangers, his general appearance is stern and forbidding, yet when speaking in public, his countenance is occasionally pleasing and attractive. In conversation he is at times free and communicative, but more generally, reserved and attentive to the sentiments of others. He is polite and solid when conversing with those with whom he is not well acquainted, and when among those whom he knows well, he is sometimes humorous, but never without manly dignity." He was born in Salisbury, New Hampshire, January 18, 1782, on a farm in the forests. He began the practice of law at twenty-three years of age, and was elected to Congress at thirty years, where he became a star in the "American galaxy," passed to the Senate chamber, and was appointed secretary of state in the cabinets of William Henry Harrison and John Tyler. He died at the age of seventy years, October 23, 1852, at his home in Marshfield, Massachusetts.

Portrait Gallery of Famous Americans

SILHOUETTE of Andrew Jackson, taken in Washington at the time of his inauguration as seventh president of the United States. He was then sixty-two years of age. Silhouettist Brown inscribed these notes regarding the personal appearance of the eminent general: "President Jackson is tall, and remarkably erect and thin. His frame, in general, does not appear fitted for the trials such as it has borne. His features are large; his eyes are blue, with a keen and strong expression, his complexion is that of a war-worn soldier. His demeanor is easy and gentle; in every station, he has been found open, and accessible to all, and those who have lived and acted with him, bear ample testimony to the general mildness of his carriage, and the kindness of his disposition." Andrew Jackson was born March 15, 1767, in Union County, North Carolina, less than a quarter mile from the South Carolina line. He always called himself a South Carolinian. His parents had immigrated to America from Ireland in 1765. At the age of fourteen years he joined the American Revolution. When twenty years of age he obtained a license to practice law, and at twenty-two removed to Nashville where his life of public service began with his election as attorney-general, as a member of the convention to frame a constitution for the state, and thence to Congress, the United States Senate, and the presidency. Upon retiring from the highest honor in possession of the American people, President Jackson returned to his estate, the "Hermitage," near Nashville, Tennessee, and lived hospitably in the manner of a substantial farmer. One who visited him in his last days said: "His amusements consist in the management of his domestic concerns." General Jackson died in 1845, age seventy-eight, having distinguished himself, fearless in war and in peace.



Portrait Gallery of Famous Americans



SILHOUETTE of John Randolph, of Roanoke, Virginia, as he appeared when embarking as Minister to Russia in 1830. Silhouettist Brown refers to him as one of the most remarkable men of his age, and makes these comments: "Mr. Randolph's peculiar personal appearance, his unique style of dress, and utter disregard of the customs of society, together with his eccentric manners, his peculiar expressions, and singular habits, rendered him an object of wonder and curiosity. In 1830 he passed through Baltimore in an old-fashioned English coach of Revolutionary times, drawn by four horses, with a postillion mounted on one of the leaders, and John, one of his favorite servants, on the box. On his mission to Russia he wore a large white hat, much too large for his head, which he kept in its place by means of a huge bandana handkerchief stuffed between his forehead and the front part of his hat, a long green coat, knee breeches and top boots. Americans, English and Russians proceeded to witness the landing of the new American Minister. He accosted the emperor with great familiarity and told him he wished to see 'madam,' and when presented to the empress he continued to address her with that appellation. He was one of the most brilliant politicians of his age and an orator of wonderful magnetism." America has never known a public character so unique in its strength. John Randolph was born at Mattox, Virginia, in June, 1773, and proud of his descent from Pocohontas. He was elected to Congress at twenty-six years of age, and for the next thirty years, with but three short intervals, during one of which he was United States senator, his powers of eloquence, at times in speeches occupying an entire day, rang through the House of Representatives. He died May 24, 1833, at sixty years of age, in Philadelphia.

Portrait Gallery of Famous Americans

SILHOUETTE of the first duly consecrated Protestant Episcopal Bishop of America, the Right Reverend William White, D.D., of Pennsylvania. The artist's notes describe him as "of venerable form, rendered infirm by age, with his long locks flowing down to his shoulders. The general respectful and affectionate salutations with which he was greeted manifested the veneration and respect which a long life of excellence and piety had inspired in the breasts of his countrymen. No gloom hung upon his brow, nor did his frown rest upon the innocent pursuits and pleasures of life. His countenance wore always the same serene expression. Ardently sincere himself, in his belief, and possessed of an expanded and well-stored mind, with urbanity of manners, and a heart overflowing with benevolence and good will to all, he was an object of much esteem with every class and every denomination. He was a man who respected the rights and opinions of others, and thereby entitled his own opinions to the respect of mankind. He was ever studiously careful to guard against the slightest infraction of Christian courtesy, in wounding the feelings of others. Bishop White was not eloquent. He did not study to please the ear and captivate the mind by the beauties of rhetoric. His sermons were of a dignified, argumentative character, pervaded by a tone of common sense." Bishop White was born in Philadelphia, April 4, 1748. At the age of fourteen he was inclined toward the ministry and at eighteen years prepared to preach. He was admitted to the priest's orders in London at twenty-three years of age, three years before the Declaration of Independence, and at the close of the American Revolution attempted to establish the freedom of religion side by side with civil liberty. He died July 17, 1836, in his eighty-ninth year.



WILL OF MARY WASHINGTON IN 1788

MOTHER OF THE FIRST PRESIDENT OF THE UNITED STATES

Transcribed from Clerk's Office at Fredericksburg, Virginia, by
MRS. HELEN COOK PORTER, of Baltimore, Maryland

IN the name of God! Amen! I, Mary Washington, of Fredericksburg, in the County of Spotsylvania, being in good health, but calling to mind the uncertainty of this life, and willing to dispose of what remains of my worldly estate, do make and publish this, my last will, recommending my soul into the hands of my Creator, hoping for a remission of all my sins through the merits and meditation of Jesus Christ, the Saviour of mankind; I dispose of my worldly estate as follows:

Imprimis.—I give to my son, General George Washington, all my land in Accokeek Run, in the County of Stafford, and also my negro boy George to him and his heirs forever. Also my best bed, bedstead, and Virginia cloth curtains (the same that stands in my best bed-room), my quilted blue and white quilt and my best dressing-glass.

Item.—I give and devise to my son, Charles Washington, my negro man Tom, to him and his assigns forever.

Item.—I give and devise to my daughter, Bettie Lewis, my phaeton and my bay horse.

Item.—I give and devise to my daughter-in-law, Hannah Washington, my purple cloth cloak lined with shag.

Item.—I give and devise to my grandson, Corbin Washington, my negro wench old Bet, my riding chair, and two black horses, to him and his assigns forever.

Item.—I give and devise to my grandson, Fielding Lewis, my negro man, Frederick, to him and his assigns forever, also eight silver tablespoons, half of my crockery ware and the blue and white tea china, with book case, oval table, one bedstead, one pair sheets, one pair blankets and white cotton counterpane, two table cloths, red leather chairs, half my pewter and one-half of my kitchen furniture.

Item.—I give and devise to my grandson, Lawrence Lewis, my negro wench Lydia, to him and his assigns forever.

Item.—I give and devise to my granddaughter, Bettie Carter, my negro woman, little Bet, and her future increase, to her and her assigns forever. Also my largest looking-glass, my walnut writing desk and drawers, a square dining table, one bed, bedstead, bolster, one pillow, one blanket and pair sheets, white Virginia cloth counterpane and purple curtains, my red and white tea china, teaspoons, and the other half of my pewter and crockeryware, and the remainder of my iron kitchen furniture.

Item.—I give and devise to my grandson, George Washington, my next best glass, one bed, bedstead, bolster, one pillow, one pair sheets, one blanket and counterpane.

Item.—I devise all my wearing apparel to be equally divided between my granddaughters, Bettie Carter, Fannie Ball and Milly Washington,—but should my daughter, Bettie Lewis, fancy any one, two or three articles, she is to have them before a division thereof.

Lastly, I nominate and appoint my said son, General George Washington, executor of this, my will, and as I owe few or no debts, I direct my executor to give no security or appraise my estate, but desire the same may be allotted to my devisees, with as a little trouble and delay as may be desiring their acceptance thereof as all the token I now have to give them of my love for them.

In witness thereof, I have hereunto set my hand and seal the 20th day of May, 1788.

MARY WASHINGTON.

Witness, JOHN FERNEYHOUGH.

Signed, sealed, and published in the presence of the said Mary Washington and at her desire.

JNO. MERCER.

JOSEPH WALKER.

Life Stories of Gallant Americans

John Thomas—Colonel of Spartanburg

Jane Thomas' Famous Ride

BY

MRS. ROBERT J. HERNDON

YORKVILLE, SOUTH CAROLINA

Tho' we must die, let me not die
In ignominious strife,
With fate invincible, and sigh
To linger out my life;
With powers decayed, enfeebled mind
And slowly slackening breath,
Burden of pity to my kind,
And dead before my death.
No, let me perish, sword in hand,
At Honor's sudden call,
Guarding my menaced Motherland
And for her safety fall.
Or mount the scaffold with firm gaze,
Martyr to some great cause,
And end my not inglorious days
For Freedom's outraged Laws.

What is this life except a trust
For nobleness and right,
The torch which, while we may, we must
Still bear and keep alight;
And when, from our exhausted will
It flickers, hand it on,
That it may burn and beckon still,
Till Time itself be gone.
But if, in unheroic days,
No great deed may be done,
Let me at least deserve this praise:
"He lived and died as one
Who looked on Life with fearless eyes,
And with intrepid mind;
So leaves, where now he silent lies,
An honored name behind."

—Selected.

AMONG the names of heroes and heroines whose magnificent courage has added such glorious chapters to the history of South Carolina during the period of the American Revolution, there is none to surpass in patriotism and devotion to country, Colonel John P. Thomas. His service and leadership in the cause of liberty and independence, and the exploits of the men and women of his family are deeds of chivalry.

The youth of the country were chiefly indebted to him for their first military discipline, and in the public affairs of his district he became an acknowledged leader. He raised the standard of independence among his people, and with strong appeals

aroused his fellow-countrymen against oppression.

The father of Colonel Thomas was English, and an officer in the King's army. During the oppression of the Presbyterians in England, he removed to Wales, where Colonel Thomas was born; and some years later in company with his brother, Reverend John Thomas, a noted Presbyterian minister, and other friends, came to America and settled in Chester County, Pennsylvania.

Colonel Thomas was brought up in this country and educated in England. He married Jane Black, a sister of the Reverend John Black, the first president of Dickinson College, Carlisle, Pennsylvania. It is said that she was a woman of rare intelligence and varied accomplishments, possess-

John Thomas—Colonel of Spartanburg

ing many charms of mind and heart. She was a superb horsewoman, of which she gave practical proof of her skill and endurance the day she made the famous ride from Ninety Six to Cedar Springs, which I will refer to later.

The colonel removed to South Carolina and resided on a commanding eminence in the beautiful region of a bold and lovely stream which, when the travelers beheld it in all its beauty of forest and flower and golden sunlight and sparkling cascades, surrounded by grand hills with their coronets of pines, one of them exclaimed: "What a fair forest this!" which still bears the name of Fair Forest Creek.

Here he was residing before hostilities commenced with the mother country. He was a militia captain and a magistrate under the royal government. He was enterprising, intelligent and patriotic, owned large possessions in land, slaves, horses and cattle, and was highly distinguished for his devotion to the public welfare. He is described as being a man of splendid appearance, above the average stature. His features were regular, his nose straight, his head finely formed, and set firmly upon his shoulders. He had dark blue eyes, which in moments of action, gleamed with fire and emotion.

Colonel Thomas's death occurred soon after the close of the war. His lonely grave lies not far from the city of Spartanburg, in the fair valley of White Stone Springs. Near by can still be seen four rooms of the house in which he died. And over and above all rises the granite hills upon whose summits the battles for liberty were fought, and victorious armies shouted their battle cry. Here amid the silence of centuries dreams this knightly soldier.

Upon the refusal of Colonel Fletcher to accept a position under the authority of the province, John Thomas was unanimously chosen

colonel of the Spartanburg regiment, having previously resigned the commissions he held under the royal government. He directed the movements of this regiment until the fall of Charleston.

Soon after he was taken prisoner by a Tory captain by the name of Brown, and confined at Ninety Six and at Charleston until near the close of the war.

This Brown, with his Tory band, returned to the home of Colonel Thomas and carried off his negroes and horses, and destroyed much of his property and family treasures. Colonel Thomas had four sons, of whom two watered the tree of liberty with their blood. Robert was killed at Roebuck's defeat; Abram was wounded and taken prisoner at Ninety Six, and died in confinement. John succeeded his father in command of the Spartanburg regiment, and made his mark in many a well-fought battle, and was deeply beloved by his men for his daring spirit and generosity.

He was one of the four prominent colonels selected to confer with Governor Rutledge and to make a full representation of the condition of the brigade and their reasons for refusing to accept Williams as their commander.

Colonel Thomas had four daughters. The husband of each espoused the Whig cause, and all held commissions in the army, and rendered their country most substantial service in securing victory and freedom.

The women of South Carolina were, and are until the present day, proverbial for being brave and patriotic, but the zeal and fidelity of Mrs. Thomas and her daughters will compare favorably with the brightest of that bright galaxy that adorns history.

In the early part of the War for American Independence, Governor Rutledge had sent a quantity of arms and ammunition to the frontier for the

Life Stories of Gallant Americans

use of the Whigs. These had been deposited in the house of Colonel Thomas, and kept under the protection of a guard of twenty-five men. Colonel Moore of North Carolina, with three hundred Tories, was approaching to take possession of the magazine. Colonel Thomas deemed his force inadequate to a successful defence of his home and retired. The guard having taken off and concealed as much of the military stores as time admitted, Captain Josiah Culbertson, a son-in-law of Colonel Thomas, refused to leave the house. He had been brought up on the frontier, and was thought to be one of the finest marksmen in the army. (He it was who fired the first shot at the battle of Cowpens.)

So with William Thomas, a lad, and the women of the family, he remained, and as soon as the Tories came in gun-shot, they all opened fire upon the British invaders with such vigor that the band soon withdrew from the conflict.

Some time after the fall of Charleston, Mrs. Thomas was on a visit to her husband and sons at Ninety Six. They were prisoners of the British at that post. While there she heard two women in conversation, and one remarked to the other: "On to-morrow night the Loyalists intend to surprise the rebels at Cedar Springs." This was interesting news to her. Cedar Springs was within a few miles of her home. Colonel John Thomas, junior, her son, was in command of the post, and with him were several of her children and friends. She therefore determined without delay to apprise them of the attack, though the distance was at least sixty miles.

Without loss of time, she made ready for the dangerous journey, and with courage as cool as it was determined, very early the following morning she mounted her horse and rode away. On and on she rode through the dark forests and lonely highways, with spirit undaunted, never falter-

ing until she reached the camp of her sons, where she informed them of their great danger in time for them to provide for safety.

When the enemy rushed on in easy confidence of victory, instead, however, of butchering a slumbering foe, they received the skilful blows of their intended victims. On that night victory perched upon the standard of liberty, and this faithful wife and devoted mother quietly repaired to her home, conscious of having done her duty.

In the midst of turmoil and strife, with unparalleled industry, she prepared clothes for the needy, food for the starving, nursed the wounded, prayed beside the dying, and buried the dead throughout the country in which she was an angel of goodness and mercy.

It is not definitely known at this time where her grave is, but it is thought more than probable that she lies buried in the McJunkin burying ground, a few miles from Union, near by the old highway which leads through Fair Forest to Tiger river. The descendants of Colonel Thomas and his wife are widely dispersed over many countries. Some are officers in the United States Navy. Others occupy positions of trust and honor in other avocations of life. Some have distinguished themselves in the wars of the present generation, bearing their country's banner into distant lands across the waters, gladly dying for its glory.

And still there are others quietly sleeping near their old home in the beautiful Fair Forest they all loved so well, under the shadows of the tall pines which stand like ghostly sentinels keeping eternal watch over the graves of the dead heroes.

Thus the names of Colonel John Thomas and his peerless wife shall shine on untarnished on the rolls of devotion to country, the example of each distant age adding new luster to the nation's history.

David Noble—Patriot of Pittsfield

He Gave His Wealth and then His Life
To the Cause of American Independence

BY

MRS. SARA B. FRANCIS

PHILADELPHIA, PENNSYLVANIA

He was a glorious old patriot. With what vividness does such a memento bring back the nature and reality of sufferings and sacrifices which are becoming to us too much like a tale that is told. Every glimpse which we thus get, into the fading story of the old time, goes to prove that it is no fiction, founded in local or family pride, that attributes to those who laid the foundation of our prosperity, an earnestness, courage, and pure elevation of character which places them in the first rank among heroes and patriots.

SENATOR DAWES.

THIS is the true story of one who gave his life and worldly accumulations to the cause of American independence. Captain David Noble was born in Westfield, Massachusetts, January 25, 1732. The surname of Noble is one of great antiquity in Great Britain. Lower, in his "Surnames," refers its origin "either to the physical structure, or to the rank, of the primitive bearer." As a surname it appears in the rolls and records of the court held before the King's justices at the close of the reign of King Richard I, in the year 1199.

Captain David Noble was of the fourth generation from Thomas Noble who is mentioned as having been admitted a citizen of that place January 5, 1653. In the same year, 1653, he removed to Springfield, Massachusetts. He appears as a resident of Westfield, Massachusetts, as early as January 21, 1669, where lands were granted to him in the year 1666.

Captain David Noble was "one of the early settlers of Pittsfield, Massachusetts, who organized and led the company of minute men which marched from Pittsfield to Boston on the news of the battle at Lexington. June 24, 1774, his name appears as

one of the ten signers of the petition to the selectmen of Pittsfield asking them to call a town meeting "to act and do what the town think proper respecting the circular letter sent out by the town of Boston and other towns in this province; and such other matters as the town shall think proper in regard to the invaded liberties of this country." In response to that petition a town meeting was held June 30, 1774, when Captain Noble was appointed a member of the "standing committee to correspond with the correspondent committees of this and other provinces."

The following letter is copied from the original, at one time in the possession of the late Honorable Henry L. Dawes, formerly United States Senator from Massachusetts. It is of striking interest as a record of the faithfulness and self-devotion of the Revolutionary heroes in "the times that tried men's souls."

MRS. RUTH NOBLE, PITTSFIELD, per favor of
MR. CHAMBERLAIN.

CROWN POINT, JULY 1, 1776.

DEAR WIFE: I would inform you that through Divine goodness I am alive but not very well, for by reason of hard fatigue before I had the small-pox, by marching and unsuitable diet, the distemper has left me in a poor state of health, though I had it very light. Ten days ago I was sent with the sick from Isle Auxnaux to this place, and have grown more poorly than better since I came here. Our army is very distressed by reason of the small-pox; we have had four thousand sick at once; I have not lost one of my company yet, though some have had it very severe; Sergeant Colfix is now very bad and it is doubtful whether he ever recovers. I had two men taken by the Indians in Major Sherbern's party, which are redeemed; and one Samuel Merry of my Company is either killed or taken by the regulars going down on a raft from Montreal to Sorrel. The distresses of our sick is so unaccountable that I cannot paint it out by pen and ink. (All my company have had it.) If

Life Stories of Gallant Americans

it was not for the danger of the small-pox I should be glad to have Brother James or David come up and see me, and bring my horse, for I intend to try to come home if I remain so poorly. I believe that one of them may come safe by taking good care when he gets here. I suppose that there is about four thousand of the well of our army at the Isle Auxnaux, and whether they will stay there or come here I do not know. Tell Croner's wife that he has had the small-pox, and has got well over the distemper, but he has had the misfortune to have it fall into one of his eyes so that I am afraid he will lose the sight of one eye. He remembers his kind love to her and child. He intends to try to come home when I come; he cannot write for want of paper. It is very hard living; wine one dollar per quart; spirits one dollar per quart; loaf sugar three shillings per pound; butter one shilling and six pence—nor to be had for that; no milk. All the above articles hardly to be had. Vinegar three shillings per quart. I shall write no more at present, but remain your loving husband,

DAVID NOBLE, Captain.

The condition of the American army at Crown Point is also referred to in a letter of John Adams, dated July 7, 1776, in which he says: "Our army at Crown Point is an object of wretchedness, enough to fill a human mind with horror; no clothes, beds, blankets, no medicine, no victuals but salt pork and flour. I hope that measures will be taken to cleanse the army at Crown Point from the small-pox; and that other measures will be taken in New England by tolerating and encouraging inoculation to render the disease less terrible."

Captain Noble's letter was written but a few days before his death, and alludes to the sickness which proved fatal to him.

Captain Noble sacrificed his entire property, as well as his life, in the service of his country. On the first alarm which spread through the country, after the battles of Concord and Lexington, he raised a company of volunteers in Berkshire county, Massachusetts, and, with his own means, "purchased one hundred and thirty stands of arms, new, for the supply of his company; drilled them

through the next winter; clothed them with regimentals, their breeches being made of buckskin, their coats of blue turned up with white; sent from Cambridge, whither he had gone, for all the goods that remained in his store at home, both linen and woollens, that would answer for soldier's clothing."

"We harvested," says his son, now deceased, in a letter written in 1836, "thirty acres of wheat, which was floured and sent to Cambridge the next winter, all excepting what our families used. My father sold two farms in Stephentown, in the state of New York, and one or two in Pittsfield about the same time. Those in the state of New York were sold in 1774, which enabled him to supply his company with their arms and clothing. The reason of my recollecting the circumstance of my father selling the farms in the state of New York is, that the men who bought them (their names were Jones and David Green) brought their money in gold, quilted around every piece of their underclothes, which took my aunt some time to rip the gold pieces out. He then went to Philadelphia and bought the deer-skins of leather, and at the same time hired a breeches-maker, and the breeches were all made up at our house."

About the time of Captain Noble's death, which occurred in Skeensborough, now Whitehall, New York, August 5, 1776, his residence, tannery, store and other buildings were burned, as was supposed, by the Tories. Neither Captain Noble nor his family were ever reimbursed by the government for the expenses and losses incurred by him in its behalf; nor did his widow and orphan children receive even the seven years' half-pay pledged by the government to the families of officers who died in the service.

There are few illustrations of truer service and more conscientious purpose in American history.

Phineas Slayton—The Venerable Volunteer

He Fought in the American Revolution and Had
To be "Coaxed to Go Home" in the War of 1812

ANECDOTE CONTRIBUTED BY

CARRIE J. DOANE OF ARLINGTON, IOWA

THERE are two traditions in my family that have been handed down through the generations. I cannot vouch for their authenticity although they have always been regarded by us as true.

My great grandfather, Phineas Slayton, served his country as minute man. At one time, during the Battle of Lexington, he was with those who guarded the ammunition and ambulance wagon. A cannon ball killed the driver. The guards all fled but Slayton who threw the dead body of the driver onto the wagon and jumping into the driver's place started the horses on a run, passing directly between two trees with sufficient room only for the horses. The wagon must have stalled but another cannon ball from the British struck the lesser tree, cutting it squarely off and lifting it above the wheels so that escape was effected.

At another time he was sent with a squad of men to guard a bridge. The road traversed a side hill. Near the bridge on the upper side was a rail fence covered by shrubbery and green leaves. Behind this rail fence was a squad of unobserved British soldiers who were sent for the same purpose. As the Americans approached, the British captain called out to Slayton: "Surrender or die." Slayton pointed his sword toward a stone wall below the road and leaped over the wall, followed by his men, in barely time enough to escape the British bullets. Then the shooting became general. Few were hurt as the stone wall proved a good shield, with the shrubbery and rail fence on other side. Slayton, seeking to get some advantage, crawled upon a stone that stood near a large chestnut tree well hid-

den by leaves. Somehow the British discovered the man near the tree and called: "Don't shoot at the stone wall! Shoot at the tree!"

"Shoot and be d-a-r-n-e-d," said Slayton in his Yankee twang. Just then the British raised up in plain sight and a volley from behind the stone wall killed or wounded half of those behind the fence. The balance fled, but returned under a flag of truce and removed the dead and wounded.

At another time Slayton was sent to relieve some starving soldiers held by the British in a floorless log house. Some of them had died with pieces of brick and earth in their mouths, so dreadful were the pangs of hunger. Neighboring women secretly tried to take some kettles of hasty pudding to them, for a temporary relief, which the British officer lost no time in kicking over upon the filthy earth floor. It is said that the poor patriots laid upon their stomachs and licked it up like dogs. Still they could have been relieved if they would only promise not to take up arms against the king. But they chose the painful death which was facing them when Slayton came to their rescue.

When the War of 1812 was declared, Slayton, with whitened head and furrowed cheeks, but full of patriotism, took his gun and started for the nearest recruiting station to enlist as a volunteer. The officer at the post laughed at him, telling him he could not shoot anything. A colloquy ensued followed by an arrangement that five of the new recruits should try the old man at a mark. The result was that the venerable recruit beat the best shot by half an inch. Then the crowd cheered and the old man was coaxed to go home and rest upon his laurels.

Contemporary Thought in America

"The Press of the Republic is the Moulder of
Public Opinion — the Leader and Educator"

CALIFORNIA

MUST AMERICAN PROSPERITY BE RETARDED

BY JOHN P. YOUNG
EDITORIAL IN
THE SAN FRANCISCO CHRONICLE

Periods of depression followed years of prosperity with such regularity that observance of the fact gave birth to a theory which has been almost superstitiously regarded by men. The vast superstructure of credit of modern times is reared upon a foundation of promise, and until very recently that foundation was not strong enough to carry the load imposed upon it by the careless builders. They kept on rearing the lofty edifice until it became so heavy that it was crushed by its own weight.

This process was usually designated as overtrading, but that is only another way of saying that men bought more than they could pay for; in other words, they promised to redeem certain obligations, but when redemption day came they could not make good because there were so many in the same condition that there was not enough of that which is demanded in the last resort to go around. The history of every depression in this country and in England conclusively establishes that lack of basic money was at the bottom of the difficulty. The talk of over-production is twaddle. The world has never yet produced more than its inhabitants can consume, and when it happens that the producer turns out more products than he can sell it will always be found that there is an obstacle in the way of the consumer getting the things produced and that he does not refrain from taking them because he does not need or is unable to use them. . . . The credit system is still abnormally developed, but the volume of promises compared with the ability to redeem them is growing relatively less. . . .

The vast addition to the world's stock of basic money renders it moderately certain that the enterprises of mankind will not soon be checked by want of the tools to prosecute them. Money is the mechanism of exchange and it looks as if there would be enough of it produced in the future to remove all apprehension of the disasters which flow from the lack of it. Modern ingenuity has achieved the triumph of bringing the production of basic money under the operation of the law of supply and demand.

MAINE

ARE THESE AMERICA'S NEEDS A GREAT PROBLEM

BY GEORGE W. NORTON
EDITORIAL IN
THE PORTLAND EVENING EXPRESS

President Roosevelt . . . is not carrying on a war against corporations because they are corporations, and he discriminates between the right doing and the wrong doing corporation, as he does between individuals. But he says the best way to cure the complaints which give rise to Socialistic ideas, is to cure the evils which do exist which give any ground for these complaints. He would not think it a fair estimate of his position to say that his idea is that the way to cure Socialism is to grant to the Socialists a part of the things for which they clamor. It is interesting to observe that the president is still of the opinion that "swollen fortunes" are a menace to our welfare, and he would have the swelling reduced through the medium of an inheritance tax plaster to be applied to the locality in which the disturbance appears. He also thinks that it is possible that an income tax law may be so drawn as to avoid the rocks of unconstitutionality, upon which the Democratic income tax boat was wrecked in the Cleveland administration, and he thinks it would be wise to try it. The president's ideas concerning many topics of national interest are of importance, particularly those dealing with the control of corporations doing an interstate business, concerning which he declares against the government ownership idea made prominent by Mr. Bryan, of marriage and divorce which he would have controlled by national legislation, of the shipping interests, and the currency problem, of the Philippine tariff, which he would have entirely removed, and the Japanese question, in which he stands for the defense of the treaty rights of aliens. He thinks still that "the United States Navy is the surest guarantor of peace which this country possesses." All he wants is that it be maintained at its present strength. As a matter of fact Mr. Roosevelt is not "afraid for the terror by night nor for the arrow that flieth by day."

Contemporary Thought in America

KENTUCKY

OMENS OF FIERCEST CONFLICT KNOWN TO HISTORY

EDITORIAL WRITER IN
THE LOUISVILLE HERALD

Close, indeed, is the understanding between France and England. It is necessary for both nations. There is Germany at the doors of France, seeking for trouble such as would justify an invasion of French soil and the dismemberment of the French Republic. That dismemberment were sure to be followed, if not, indeed, accompanied, by the seizure of Belgium and Holland, giving the Kaiser the front windows of the Continent to look out onto King Edward's white-cliffed island. The Moroccan trouble almost brought matters to a head. Germany found no support at Algeciras to justify war, or even suggest, in that event, anything like certainty of success. She accordingly decided to keep her purposes for some time longer in abeyance. A Paris correspondent now writes: "Matters had reached such a stage during the Morocco crisis that England's physical, as well as diplomatic, support was certain had the sword been unsheathed. At that time military and naval authorities of the two countries were in communication, and after the crisis had passed they proceeded to work out 'in a purely technical fashion' plans of co-operation by land and sea to meet certain eventualities."

At every point King Edward has skilfully blocked his ambitious nephew. The establishment of the new—or rather revival of the old—kingdom of Norway under practically British auspices is a wall against German schemes on that side. The marriage of the Princess Victoria of Battenburg to the King of Spain makes the latter government friendly to Britain on a critical portion of the map. The Kaiser will have to wait. If, however, he decides to make a break, the conflict will be the fiercest known in history.

VIRGINIA

NORTH AND SOUTH ARE UNITED FOREVER

EDITORIAL WRITER IN
THE RICHMOND TIMES-DISPATCH

If Southern Democrats desire to name the next presidential candidate they must agree on the man before they go to the convention; they must go to the convention with a solid South. It may be argued that this would appear to the North as a revival of the Southern Confederacy, would alarm the people of that section and drive them into the Republican party. That would depend on the temper of the conference. If it should be composed of hot-headed men, and if hot-headed resolutions should be adopted and a hot-headed Southerner nominated, the North would probably be "alarmed." But is there danger that the conference would be so composed, and that it would take that turn? Can we not trust our own leaders? If not, we ought not to take chances, and we ought to give up all idea now of nominating a Southern man. But if representative Democrats from every Southern state would assemble in the "capital of the Confederacy," and by their deliberations and conclusions convince the North that they were altogether safe and sane and patriotic, then concentrate on a Southern Democrat who was himself safe, sane and patriotic, the net result of the conference would be to give the Southern Democracy enormous prestige in national politics to nominate the man of their choice, and in all probability to elect him. Time was when the word "Southern" was a term to arouse prejudice; nowadays it is a word to conjure with. That is certainly true in the business and financial world; why not in the political world as well? For our part, we believe that prejudice against the South has so far disappeared that a majority of Democrats of the North and West would be delighted to see true Southern Democracy once again in control in Washington.

Contemporary Thought in America

SOUTH CAROLINA

HUMAN BROTHERHOOD HANDS ACROSS THE SEA

EDITORIAL WRITER IN
THE CHARLESTON NEWS AND COURIER

Every evening a great throng of people gather under the dome of the — Hotel in Paris. They come from every nation and tribe and tongue and kindred in the world. . . . It is all life and beauty and motion, the prince and the commoner jostling each other in good-natured spirit as they mingle together in a delightful comradeship to be found nowhere else. . . . Symphonies exquisitely rendered, waltzes and marches and ballads, solos and duets and sextettes, and descriptive passages from the greatest and most familiar grand operas, and great because they are familiar, follow in delightful order until suddenly with magical effect the whole dome blazes with its myriad lights and the orchestra plays "Hands Across the Sea," and all the crowd, whatever its language or race, breaks into the most enthusiastic applause. . . . Great musicians would probably regard the incident as reflecting upon both the intelligence and sense of appreciation of the ever-changing audience. They would say doubtless that it was inartistic, that it was not in keeping with the best traditions of the schools, that the trained musical mind could not applaud the cheap, but catchy two-step style of Sousa, and they would be exactly right; but the human race is not artistic, except by careful culture, and the heart is moved by human sympathy, whether it be excited by the cry of an infant in distress or the harmony of sounds which touch the hidden springs of emotion. Strange as it may seem to the educated mind, there is in "Hands Across the Sea" just that little telepathic touch which places us in communication with those who are at a distance, whether they are still with us in this experimental existence, or whether they have passed on into the light of another more exalted state. The hands of those who were here for a little while are reaching out to those whom they left behind across the sea that separates us from the infinite and eternal that lies beyond the bounds of time and sense.

DIST. OF COLUMBIA

MAN'S AMBITION—QUEST OF THE NORTH POLE

EDITORIAL WRITER IN
THE WASHINGTON POST

A number of reputable and presumably influential newspapers are uttering protests against further attempts to reach the North Pole. They point to a long list of failures, most of them involving dreadful tragedies, and they all agree that the discovery of the pole could not be materially beneficial to mankind. This is precisely what *The Post* did for a long time. While admiring and commending the courage and fortitude exhibited in this quest, *The Post* showed that the game was not worth the candle and sought earnestly to discourage it. But when it became evident that its protests against efforts to reach the pole, no matter how disastrous they may be, no matter how awful the reports of privation, suffering, death, and worse than death might come out of the frozen north, were utterly futile, *The Post* called a halt on its humane efforts. *The Post* does not believe that as a business enterprise the effort to reach the pole is worth considering. No one has any reason to believe that its successful accomplishment would be an achievement of commercial value. Nevertheless, it is vain to cry out against it. So long as any part of this globe remains unexplored, no matter how apparently inaccessible it may be, there will always be men to volunteer for its exploration and capital to fit out expeditions. This arises from the same cause that has been pushing the human family along in all the ages. It is the product of discontent. The human mind is constitutionally incapable of contentment or rest so long as nature hides secrets or art can find possibilities of further conquest. Therefore, the North Pole quest will go on even if scores or hundreds of victims are added to the number of those who have laid down their lives in the hitherto vain endeavor. And perhaps science in this field is less unreasonably employed than it is in speculating on Martian canals or in attempts to wrest from the Creator the secret of life.

THE LAST LEAF

The key of Yesterday
I threw away,
And now, too late,
Before tomorrow's close-
locked gate

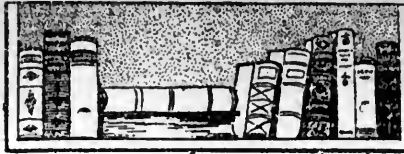

Helpless I stand—in vain to
pray!
In vain to sorrow!
Only the key of yesterday
Unlocks to-morrow!

EDITORIAL COMMENT

This last leaf is inscribed to all Americans who are serving their country. Not alone those who have made self-sacrifices in war and in peace, but to the Greater American People who are serving their country by each day's work, well and conscientiously done. The world is a great workshop in which we are all artisans plying one of the trades and deftly adding our own workmanship to the edifice of Truth and Justice which the generations are building. The structure of the future American Republic is being modeled by you and your friends and their friends' friends. Its strength and its weakness will be commensurate with the strength and weakness of its people. Bliss Carmen, the poet and aesthete, once said that it matters little whether a man draws, or digs, or makes music, or builds ships—in the work of his hands is the delight of his heart, and in that joy of his heart lurks his kinship with his own Creator. Liberty means not license, but largeness and balance of manhood, that men go right, not because they are told to, but because they love that which is right. The heart of self-government is the earnestness, the self-respect, the industry of its people—and in just such proportions as these qualities are inculcated into the American people will they be found in the Republic.

The millions who have gone before have countless stories to tell—true stories of noble impulses, and sweet benevolences that strengthen one's faith in humanity. While gallantry in war will always meet laudations by those who record history, there is a greater army of Common Soldiers in the Common Cause of Right whose names are never emblazoned on the scrolls of conflict or inspiring victory. Their service to their country is their simple, good lives. They were not epoch-makers. They did not jolt the great world along in a single blow. But this they did—they lived honorably, they worked industriously. To them the American Republic owes the sacredness of its homes, the integrity of its institutions, the stability of its citizenship; its foundation and its existence; its past, its present, and its future. The men knighted by history owe much to the manhood of the silent men in the ranks. It is an Americanism that this is a land of, for, and by the people. Inasmuch as it is the individual citizen who contributes to the great body of American citizenship, molding its character, which in turn is but a composite of the individual citizens, the History of a Republic, unlike that of the monarchy, *must* be written by every man and woman who lives and labors under its ensign.

The pages of this book are but the stories that the workmen tell after the day's work is done, inviting you to joy in their good fortunes, to laugh with them in their joviality, to lend a hand of brotherly affection in their sorrows. It is here that one may sit with the toilers about the evening fire and listen to their narrations of the long-gone days, of the roads they traveled and the tales they told along the way—simple stories of human lives, of physical courage and of moral worth. To hear them relate their experiences is like standing on the mountain heights where the vision of the world below is clear, and to look down on the generations of men and women who have come and gone. There in the fields is the multitude of workers; in the meadows are the little ones, who, now in the playtime of life, are so soon to take up the tools of labor as they fall from the hands of the workers; there on the hill-sides are the young men and women, climbing, climbing the steeps that they may catch a glimpse of the golden light before the set of sun. On the hilltop one sees against the skyline the bent figures of the aged, their silvered hair glistening in the sunlight, and their gnarled hands lifted, with their faces toward the Promised Land. This is the beautiful unfolding of the past.

A few days ago the eminent Dr. Lyman Abbott remarked that we are now passing through as great a revolution as that through which our forefathers passed, and that to-day our Government does a thousand and one things never anticipated by its founders. To understand the progress of these events we must know first what the first citizens really intended. While the demands of the age are so great that only the few can pursue historical researches, the hearts of the American people to-day are more patriotic than ever before. They absorb knowledge with a versatility that the world has never before known. This is an epoch, too, when men cannot be narrowed down to treatises and doctrines. They must think for themselves. They prefer to commune directly with the men who know because they were there. It is the privilege of these pages to record the first-hand narratives of such men that we may form our own conclusions on "the progress of events"—conclusions based whenever possible on the testimony of eye-witnesses—to receive the testimony of those who witnessed the laying of the foundation, of those who are to-day setting the keystone, and of those who will have life-stories to inscribe of events in years to come—to all Americans—North and South, East and West.

The Journal of
American History





386^a



ROBERT FULTON, THE FATHER OF STEAM NAVIGATION
Painting by his intimate friend and fellow-artist, Benjamin West—Original
now in the possession of Fulton's grandson, Robert Fulton Ludlow, of
Claverack, New York — Centenary reproduction in the Journal of American
History by permission of the Fulton family and by courtesy of the Nautical Gazette

The Journal of
American History

Relating Life Stories of Men and
Events that have entered into the
Building of the Western Continent

REPRODUCTIONS FROM RARE
PRINTS AND WORKS OF ART
(AMERICANA)

Original Researches into Authoritative Sources—American, British and
European Archives—Private Journals, Diaries and Hitherto
Unpublished Documents—Fugitive Papers—
Reminiscences and Memoirs—
Folklore and Traditions

Associated Publishers of American Records

Produced by the Associated Publishers of American Records, Inc.
 in the Ancient Municipality of New Haven, Commonwealth of Con-
 necticut, in Quarterly Art Editions, four books to the volume
 at Two Dollars annually, Fifty Cents a copy & Compiled
 in Collaboration with the Connecticut Magazine
 Protected by copyright and Printed from press
 of the Borman Lithographing Company
 Publication entered at the Post
 Office at New Haven as mail
 matter of the second class
 Nineteen Hundred
 and Seven



Foreign

Three dollars annually & Seventy-five cents a copy

LONDON	B. F. Stevens & Brown 4 Trafalgar Square, W. C.	ST. PETERSBURG	Watkins and Company Marskaja No. 36
PARIS	Brentano's 37, Avenue de l'Opera	CAIRO	F. Diemer Shepherd's Building
BERLIN	Asher and Company Unter den Linden 56	BOMBAY	Thacker and Company Limited Esplanade Road
DUBLIN	Combridge and Company 18 Grafton Street	TOKIO	Methodist Publishing House 2 Shichome, Giz Ginza
EDINBURGH	Andrew Elliott 17 Princess Street	MEXICO CITY	American Book & Printing Co. 1st San Francisco No. 12
MADRID	Libreria Internacional de Ad- rian Romo, Alcalá 5	ATHENS	Const. Electheroudakis Place de la Constitution
ROME	L. Piaale 1 Piazza di Spagna	BUENOS AYRES	John Grant & Son Calle Cangallo 469

Syllabus of the Fulton Memorial Number

FIRST VOLUME

THIRD NUMBER

Collecting the Various Phases of History, Art, Literature, Science, Industry, and Such as Pertains to the Moral, Intellectual and Political Uplift of the American Nation—Inspiring Nobility of Home and State—Testimonial of the Marked Individuality and Strong Character of the Builders of the American Republic

HERALDIC ILLUMINATION—Coat-of-arms of the Fulton Family in America—Illuminated especially as a Memorial to Robert Fulton, the promoter of steam navigation, on this Centenary of his achievement—Emblazoned in six colors By Charles L. N. Camp	
PAINTING OF ROBERT FULTON—By his intimate friend and fellow-artist, Benjamin West—Original now in the possession of Fulton's grandson, Robert Fulton Ludlow, of Claverack, New York—Centenary reproduction in sepiatone in the "Journal of American History" by permission of Fulton family.....	392
THE MESSAGE TO THE AMERICANS—Poem.....By Judge Daniel J. Donahoe	393
THE ANNIVERSARY OF AMERICAN COMMERCE—Ter-Centenary of the building of the "Virginia," the First Ship Constructed on the Western Continent—Centennial of the "Clermont," First Steamboat in the World—The Rise of the American Merchant Marine and the Development of a Century of Navigation since Robert Fulton—Illustrated with many rare blue-prints and engravings By C. Seymour Bullock	395
ROBERT FULTON AS AN ARTIST—Reproduction in sepiatone of his painting of Joel Barlow, the poet and diplomat, who was Fulton's most intimate friend when the inventor proposed to Napoleon the power of steam as a destroyer of the navies of the world but met with rebuff—Original is now in possession of the Barlow family in New York and a replica is owned by Fulton's grandson, Robert Fulton Ludlow of Claverack, New York.....	401
FIRST COLLECTION OF STEAMBOAT PAINTINGS IN THE WORLD—Blue-print reproductions of James Bard's Famous Canvasses of Early American Marine Architecture	413
MAP OF NEW YORK A CENTURY AGO when first successful steamboat in the world, the "Clermont," sailed up the Hudson river—The city then had about 83,000 inhabitants and was concentrated below Spruce Street—It was then planned to preserve a system of boulevards along the water-front and construct harbors rather than piers for shipping purposes—Modern commerce made this aestheticism impractical and the rise of steam navigation sacrificed municipal art to the greater demand of public utility	416
A CENTURY OF STEAM NAVIGATION—A series of sixteen of the first steamboats to sail inland waters from the port of New York—With double-page natural-color reproduction of the modern "Hendrick Hudson".....	423
FACSIMILE OF LETTER WRITTEN BY ROBERT FULTON in which he confided his doubts in the problem of steam navigation—Original in the archives of Lenox Library, in New York.....	433
AMERICAN PROGRESS IN THE MIDDLE WEST—Voice of the people as expressed through the Governors of the American Commonwealth and the "Journal of American History".....By Honorable Albert B. Cummins, Governor of Iowa	433
"WE WANT PATRIOTS IN EVERY-DAY LIFE"—Excerpt from speech made by Honorable Charles E. Hughes, Governor of New York	434
AMERICAN PROGRESS IN THE GREAT SOUTHWEST..By Hon. Thomas M. Campbell Governor of Texas	435
THE MILLENIUM OF AMERICAN CITIZENSHIP.....By Hon. Curtis Guild, Jr. Governor of Massachusetts	436
BOUNDLESS RICHES OF THE AMERICAN INTERIOR....By Hon. George L. Sheldon Governor of Nebraska	437
THE RISE OF THE BOUNTIFUL SOUTH—Excerpt from speech by Honorable Claude A. Swanson, Governor of Virginia	438

INDEX CONTINUED (OVER)

Context with Engravings and Authors

THIRD QUARTER

NINETEEN SEVEN

Chronicles of Those Who Have Done a Good Day's Work—
Rich in Information upon Which May Be Based Accurate
Economic and Sociologic Studies and of Eminent Value to
Private and Public Libraries—Beautified by Reproductions of
Ancient Subjects through the Modern Processes of American Art

CONTINUATION OF INDEX

- THE AMERICAN SPIRIT IN THE MISSISSIPPI VALLEY.....By Hon. Joseph W. Folk
Governor of Missouri 439
- TRADE OF A MULATTO BOY IN 1765—Accurate Transcript from Original Document
in Possession of.....Mary R. Woodruff, Orange, Connecticut 440
- AN AMERICAN'S EXPERIENCE IN THE BRITISH ARMY—Manuscript of Colonel
Stephen Jarvis, Born in 1756 in Danbury, Connecticut, Revealing the life of the
Loyalists who refused to renounce allegiance to the King and fought to save the
Western Continent to the British Empire—Original Manuscript now in possession
of.....Honorable Charles M. Jarvis, New Britain, Connecticut 441
- SONNET.....By Horace Holley 464
- PILOT OF FIRST WHITE MEN TO CROSS THE AMERICAN CONTINENT—Identifica-
tion of the Indian Girl who Led the Lewis and Clark Expedition Over the Rocky
Mountains in their Unparalleled Journey into the Mysteries of the Western World
—Recognition of Sacajawea as the Woman who Guided the Explorers to the New
Golden Empire—With nine reproductions from sculpture and rare prints
By Grace Raymond Hebard, Ph.D., of the University of Wyoming 467
- THE NOBLER RACE—Poem.....By Frank P. Foster, Jr. 484
- LIFE ON AN AMERICAN TRADING VESSEL—Adventures on the High Seas in the
First Days of American Commerce when Privateering was a Prosperous Occupa-
tion and Daring Men Chose the Hazards of Seamanship—Journal of Samuel Hoyt,
an Early American Sea Captain, Born in 1744—Transcribed by Julius Walter Pease 485
- IN THE FIRST HOMES IN AMERICA—With reproductions of antique furniture
By Clara Emerson Bickford 494
- SECRET SERVICE OF AMERICAN REVOLUTION—Incidents in which Imminent Defe-
at was turned to Glorious Victory—Repressing the Ravagers of Property on the
Outskirts of the Army—Anecdotes of Colonel Henry Ludington, Born 1739, and the
Heroism of his Daughters who Saved him from Capture and Execution—Related
by.....Louis S. Patrick 497
- OATH OF ALLEGIANCE TO KING GEORGE III—Sworn to by Colonel Henry Luding-
ton on March 12, 1763, in Dutchess County in the Province of New York, before
being allowed to take office as Sub-Sheriff—Accurate Transcript..... 501
- AN AMERICAN'S OATH OF ABJURATION IN 1763—Sworn to by Colonel Henry Lud-
ington when appointed to the office of Sub-Sheriff—Accurate Transcript from
originals in collection of Poughkeepsie, New York Literary Club..... 501
- PLEDGE OF THE PATRIOTS TO FREE AMERICA—Signed by Americans in 1776—
Transcript from Original in Possession of the Misses Patterson of Patterson,
New York—Colonel Henry Ludington Renounced his former oaths and signed this
document at the beginning of the American Revolution..... 503
- PLEA FOR PROTECTION FROM THE ENEMY—Accurate Transcript from Original
letter written by Colonel Henry Ludington after he had espoused the cause of
American Independence and his oaths to the King..... 503
- HERITAGE OF YEARS—Poem.....By Howard Arnold Walter 508
- WILLIAM PYNCHON—An Immigrant to the New World in 1630—An Oxford Graduate
who came to the Western Continent as an Indian Trader and settled on the trail
—He accumulated wealth and founded a family which has contributed liberally
to American Progress—Nathaniel Hawthorne's Controversy with the Pynchon
family over his novel—Heirlooms of the early American pioneers—Described by
Blanche Nichols Hill 509
- BOOK PLATE OF REVEREND THOMAS RUGGLES PYNCHON, President of Trinity
College, Hartford, Connecticut—Descendant of William Pynchon, 1630..... 516

Transcripts from Ancient Documents

JULY

AUGUST

SEPTEMBER

This opportunity is taken to thank the many eminent scholars from both Continents who have so kindly sent expressions of appreciation to this new American journal. The generous sentiments of Americans, and its immediate recognition by the leading American and foreign libraries, is most gratifying

CONCLUSION OF INDEX

<p>PROGENY OF SAXON KINGS IN AMERICA—Unbroken Line of Descent from Egbert, First King of all England—800-838, to Willam Tracy of Hayles Abbey who came to America in 1620—Royal Lineage Sustained through Thomas Tracy of Connecticut, 1636—Illustrated with eighteen Rare Reproductions from Ancient Documents Dwight Tracy, M.D., D.D.S. 517</p> <p>FATHER OF BIBLICAL CULTURE IN AMERICA—Reminiscences of the First American Biblicalist who found Religious Thought under Dominion of Iron-Bound Metaphysics and Disenthralled it from its Slavery—First Contributions to Biblical Literature and First School for Education to Ministry—Life of Moses Stuart—Born 1780.....By John Gaylord Davenport, D.D. 545</p> <p>REMINISCENCES OF MOSES STUART—Born in 1780—By his daughter Mrs. Sarah Robbins, Newton Highlands, Massachusetts 557</p> <p>PERSONAL LETTERS OF PIONEER AMERICANS—Glimpses into Time-stained and almost indecipherable Correspondence Revealing the Strong Character, Conscientious Lives, Domestic Customs, Business Integrity and Courageous Hardihood of First Citizens of the Republic—Contributed by.....Miss C. C. Thacher 559</p> <p>FIRST NEWS OF AN AMERICAN VICTORY—This is an account of the joy that reigned throughout America on the news of victory, told by an eye-witness, Stanton Sholes, who was born March 14, 1772, married Abigail Avery on March 14, 1793, and died February 7, 1865, at Columbus, Ohio, in his ninety-third year—Accurate transcript from Original Manuscript—Contributed by Sarah Elizabeth Sholes Nighman, great-granddaughter of the narrator Bayonne, New Jersey 563</p> <p>LIFE STORIES OF GALLANT AMERICANS—The Lanes—Cavalliers of the South—In the Wars of Early America...By Mrs. Louisa Kendall Rogers, Barnesville, Georgia 565</p> <p>THE HISTORIAN—Poem.....By Herbert Hughes 567</p> <p>FAIR, COOLING SPRAY, O LOVELY SEA!.....By Dr. Frederick H. Williams 568</p> <p>ON THE HILLTOPS.....By Josephine Canning 568</p> <p>COUNTRY LIFE IN AMERICA—Series of blue-prints of summer landscape views..... 569</p> <p>ESTATE OF "A WELL-TO-DO" VIRGINIAN IN 1674—Transcribed from the Original by Dr. Joseph Lyon Miller, grandson of the Seventh Generation, Thomas, West Virginia 573</p> <p>CONTEMPORARY THOUGHT IN AMERICA—The Press of the Republic is the Moulder of Public Opinion—the Leader and Educator..... 575</p> <p>THE AMERICAN PEOPLE MUST LEAD VAN OF PROGRESS—Editorial writer in the "Denver Republican"..... 575</p> <p>CIVILIZATION'S GREAT WORK IS IN ITS BEGINNING—Editorial writer in the "Toledo Blade"..... 575</p> <p>AN ATTEMPT TO SOLVE THE RIDDLE OF THE PLANETS—Editorial writer in the "Philadelphia Inquirer"..... 576</p> <p>AMERICAN SCIENTISTS BELIEVE JAPANESE ARE CAUCASIANS—Editorial writer in the "Indianapolis Star"..... 576</p> <p>WILL MAN HARNESS POWERS OF SUN, MOON AND TIDE?—Editorial writer in the "Baltimore Sun"..... 577</p> <p>UTILIZATION OF INVENTION OF GENIUS OF MAN—Editorial writer in the "Pater-son Morning Call"..... 577</p> <p>THE LAST LEAF—Editorial Comment..... 578</p>	<p>517</p> <p>545</p> <p>557</p> <p>559</p> <p>563</p> <p>565</p> <p>567</p> <p>568</p> <p>568</p> <p>569</p> <p>573</p> <p>575</p> <p>575</p> <p>575</p> <p>575</p> <p>576</p> <p>576</p> <p>577</p> <p>577</p> <p>578</p>
---	---

THE UNIVERSITY OF CHICAGO

The Journal of American History



VOLUME I
NINETEEN SEVEN

EDITED BY FRANCIS TREVELYAN MILLER

NUMBER III
THIRD QUARTER

The Message to the Americans Pause, O My Brothers

BY

JUDGE DANIEL J. DONAHOE

PAUSE, O my Brothers, in your maddening strife;
Pause, and behold the folly of your haste!
The voice that ye have honored as of God,
And in your anxious fear, strive to obey,—
The master who hath stamped upon your souls
As holy doctrine that outworn decree,
"Each for himself," is false to God and you.
Cease from your strife, and lift your souls aloft
Among the sunny clouds, where the sweet air
Shall fill your lives with joy and deathless truth.

Behold, O Toilers, all this beauteous world,
That, with the air and ocean, comes to you,
Children of love, free as the spacious heavens,
The gift of everlasting Charity!
See how it lies before you, all unmarred
By evil or by foul deformity,
A wondrous gift from God, your generous Sire,
To you, O Brothers, children of His love.

The concave heaven, where all night long the stars
Move with calm faces, and all day the clouds
Are blown in ever-changing loveliness;
The pulsing ocean, kissing the white beach

With ever-rolling billows; and the earth
With her wide inland seas, her flooding ways,
And roaring mountain torrents,—these are yours;
Yours—and the voice that dares deny your claim
Shall fall dishonored by the works of God.

Pause, listen and behold! The skies proclaim
Man's majesty; the air bows to his rule;
Earth with her mountain floods, forest and mines,
Stoops to his conquering might; and ocean's waves
Bend in fierce storms obedient to his will.
Yea! unto you, Majestic Brotherhood,
The everlasting Love hath given the rein
O'er nature's wondrous forces.

Not to one,
Nor to a few, nor the surviving fit,—
Detested word, meet but for murder's tongue,—
Are God's great mercies measured; but to all,
To each and all, one general Brotherhood,
He giveth of His everlasting love
In everlasting measure; to man's race
He giveth soul and sense and a sweet home,
Wherein to live and love and bless His name.

Yours is the air, with all its wondrous powers;
Yours is the earth, with all its teeming wealth;
Yours is the water; flowing round the globe;
And yours the power to curb and conquer all.

But yours must be the might that bindeth fast
Each unto each; for every man shall know
His brother's welfare and his own is one;
Shall feel forevermore, o'er all the earth,
The gentle love that sees a Fatherhood
In God's all-powerful being, and in Man
The sweetness of one general Brotherhood.

Such love will fill your souls with wisdom's might;
Will show the vanity of selfish strife,
And the sweet joy of one united will.
The cruelty and greed of natural man
Shall thaw and melt away in its mild warmth,
And grace shall rule the heart with serene power.

Hark to the message, while the morn is young!
Lift up your souls unto the sunny clouds,
And learn the living wisdom of God's love.

Anniversary of American Commerce

Ter-Centenary
of the Building of the
"Virginia," the First Ship Constructed
on the Western Continent & Centennial of the "Clermont,"
First Steamboat in the World & The Rise of the American Merchant
Marine and the Development of a Century of Navigation since Robert Fulton

BY

C. SEYMOUR BULLOCK

AUTHOR OF "THE MIRACLE OF THE FIRST STEAMBOAT," "FIRST STEAMSHIPS TO CROSS THE OCEAN," AND A
RECOGNIZED AUTHORITY ON THE SUBJECT OF STEAM NAVIGATION

THIS is the three hundredth anniversary of the building of the first ship on the American continent, and the one hundredth anniversary of the first practical steamboat in the world. The former will be observed in Maine where the little two-masted bark, "Virginia," was built on the Kennebec river in 1607—the birth of the American merchant marine. The latter will be celebrated throughout the civilized world, receiving special recognition in France and America.

The Americans are preparing to pay the tribute of a loving people to one of their own fellowmen who gave to all races and all nations the secret of the world's material progress, commerce. When the "Clermont" steamed up the Hudson river on that day in August, 1807, the people laughed it to scorn as "Fulton's Folly." The legislature could not be impressed with the sincerity of its promoters and ridiculed the petitions for exclusive right of navigating steam vessels in the waters of New York.

A few days ago, one hundred years having intervened, the legislators of this same commonwealth conferred a rich grant at the gate of the Western Continent, covering two blocks in the

harbor of the American metropolis, extending from One Hundred and Fourteenth street to One Hundred and Eighteenth street, New York, and extending to a depth of forty feet in the Hudson river. Here will be constructed a water-gate, through which all the ships of the world may approach, a magnificent memorial to the memory of Robert Fulton—a treasure-house of all that pertains to steam navigation, containing a museum and reception hall. The relatives of Robert Fulton have granted permission to remove his remains from the present resting-place in the Livingston vault in Trinity churchyard to this place of state overlooking the river which he loved and on which he endowed mankind with his genius.

One hundred years ago this struggling inventor roamed two continents to find a few paltry dollars with which to improve the navigation of the seas and revolutionize the world's trade. To-day more than a half million dollars are willingly and lovingly offered as tribute to his memory by a grateful people. It is the wonderful story of his struggles that is here told, taking one back through the century to the man himself and that August day when the world was awakened from its slumbers by the dawn of a new epoch.

1607—Ter-Centenary of American Commerce

THE world absolutely refused to accept the theory that ships could be propelled against wind and tide by a subtle power known as steam. The men who tried to persuade the people of several nations to give them an opportunity to prove it is a list of fatalities—of tragedies. Jonathan Hulls, the Englishman, and John Fitch and James Rumsey, Americans, offered the great secret to their fellowmen only to receive their rebuffs and ridicule. Other men with ideas founded upon the theories of these first martyrs to invention stepped into the same pit of public disapproval until at last there came one, Robert Fulton, a persistent, prodigious, indomitable man, who forced the world to listen. It is on this hundredth anniversary of his achievement that I ask the respectful hearing of all Americans.

Wearied with his uneven fight against the prejudices and the indifference of a world to whose service he had thought to bridle the very waters of the sea, John Fitch had retired to his lands in Kentucky and there, after an illness of many weeks, died. A short time before his death he wrote to Dr. William Thornton, whose friendship for Fitch and confidence in the practicability of his ideas seems never to have wavered, the following pathetic letter:

BARDSTOWN, NELSON COUNTY, 1ST, FEBY,
1798.

"MY WORTHY FRIEND

I am going fast to my mother clay. Yesterday I executed my last will which I ever mean to make. My property hear will be much more than I ever expected. . . . Address letter for me to Mr. John Rowan, Bardstown. If I am hear I can pay the postage, if not he will have enough in his hands. I shall transact no more business of myself but leave it altogether to him.

my worthy friend I have many more things to inform you and Mr. Vail but being fatigued shall only say

that I am
and shall die
a friend to both of you
JOHN FITCH

DR. WILLIAM THORNTON, ESQ.

P S if possible let me receive one letter more from you J F"

Fitch had but recently returned from his fruitless trip to England and France, where it was hoped to build a larger boat than any that had been attempted on the Delaware, but France had just put to her best life the knife of suicide and the people were too busy thinking out schemes for getting rid of one another to concern themselves in the plans of any stranger with a project for utilizing the untried force of steam. After a brief stay with the United States' Minister Vail at L'Orient, Fitch, in spite of his earlier leanings toward skepticism, turned his back upon the people who were wearing miniature guillotines about the neck just as beauty now adorns itself with chain and locket, and started for London where he sought out his friend Leslie, of Philadelphia, through whom he was introduced to the Earl of Stanhope, one of the most eminent engineers of the day, and to William Symington, builder of the "Charlotte Dundas," England's first successful steamboat, which was launched in 1801 and used to tow boats upon the canal in 1802. It was laid aside after the death of the Duke of Bridgewater, which caused a lack of funds necessary to make changes so that the waves caused by the boat would not wash down the banks on either side. This was in 1793 and from this time dates the first correspondence between these early investigators and experimentors and Robert Fulton upon which it is thought to base a claim for priority of suggestion in the use of steam for navigation.

"Sir: I have received yours of the 30th of September, in which you propose to communicate to me the principles of an invention which you say you have discovered, respecting the moving of ships by means of steam. It is a subject on which I have made important discoveries. I shall be glad to receive the communication which you intend, as I have made the principles of mechanics my particular study." * * *

1807—Centennial of Steam Navigation—1907



CLERMONT, 1807, 133 FEET



CHANCELLOR LIVINGSTON, 1816, 154 FEET



ERIE, 1832, 180 FEET



ROCHESTER, 1836, 209 FEET



DANIEL DREW, 1860, 251 FEET



C. VIBBARD, 1864, 281 FEET



ALBANY, 1881, 325 FEET



NEW YORK, 1887, 350 FEET



HENDRICK HUDSON, 1906, 400 FEET

DESIGN BY "THE NAUTICAL GAZETTE,"
the Authoritative Journal of Navigation in America

When Fitch left France for England all the drawings and specifications that he had taken with him from

this country were left in the hands of the United States Minister, who had been a member of the original company for building steamboats on the Delaware with the hope that he would be able to interest the French engineers in the project after they had taken time to investigate it more fully. The flag, too, that Governor Mifflin of Pennsylvania had placed on the original boat was left with him. Later on these drawings were turned over to Chancellor Livingston, and became the basis for his more intelligent study of a theme to which he had already given considerable attention and in which he had made a number of fruitless experiments. The Chancellor then urged Fulton to take up the project of steamboats, which he seems to have dropped after his correspondence in 1793. In this he was seconded by Joel Barlow, who, after the expiration of his term of service as consul, had taken up his home in Paris. The flag was afterward given into the keeping of General Pinkney, then minister of the Court of St. James, and through him it came into the hands of Rufus King, his successor at the court, by whom it was returned to this country.

I have already written fully, in the pages of this most valued journal, of the pioneer John Fitch and would not abate one word of the praise given him, but I would not, even for his sake, take one leaf from the crown with which the years have honored Robert Fulton for his part in the development of that one force which, more than all others, has been potent in changing the trend of civilization. To Robert Fulton belongs the glory of having built and navigated the first steamboat on the Hudson, the boat from which has been developed those magnificent floating palaces, unequalled in grace of line, point of comfort, attainment of speed, or reliability of service by the water-craft of any other country in the world.

1607—Ter-Centenary of American Commerce

Who was this man who rose from the multitude and opened the door of a new epoch, greater than the world could conceive, and the prophecy of which it repudiated as the folly of a dreamer? In searching through the British Records I find a Reverend Dr. Robert Fulton of Scotland, who was appointed by the Privy Council September 8, 1614, to serve as chaplain to the Lady Arabella Stuart, first cousin of King James the First of England. The Lady Arabella was at that time imprisoned in the Tower of London for having assisted her husband, William Seymour, afterward first Marquis of Hertford, in his escape to France.

There is romance and chivalry in this story that I would like to narrate, but I must here confine myself to that which relates only to the progenitor of commerce. In conversing a few days ago with the descendants of this Dr. Fulton, they assured me that the American genius of steam navigation is in lineal descent from this friend and spiritual adviser of the unfortunate Lady Stuart. Dr. Fulton settled in Kilkenny, Ireland, in the time of Cromwell and several of his descendants came to America. One of them, bearing his name, Robert, settled in Philadelphia. It is in this city at this same time that a tailor of the same name resided and it is claimed that he was the American heir of Dr. Fulton of Kilkenny.

This Philadelphia tailor, who had married Mary Smith, by some of Fulton's biographers said to have been the daughter of a respected Pennsylvania family, and by others conceded to be an open question with no way of deciding whether or not the marriage occurred in Scotland, moved into Lancaster township, where, in 1759, they bought a home which was sold six years later, and on the same day they purchased a farm in Little Britain township. It was on this farm that Robert Fulton, destined to revolutionize the world's trade, was born in 1765.

Some of his biographers have said that the date of his birth was not recorded, but as I find it mentioned in one of his letters that he wanted to be with certain friends on the fourteenth of November, his "birthday," it is hard to see why there should be raised any question as to the date.

Two girls had already come to the Fulton home, and after the coming of Robert, another girl and a boy arrived to complete the family circle. In 1766, this farm was sold to the Swifts and the family once more moved back to Lancaster where the father died and was buried within the wall-encircled burying-ground near the little, old, limestone church that he had helped to build, helping also to organize its society, of which he was one of the deacons. Among the slender marble slabs and the crumbling red sandstone panels that marked the resting-places of the dead, all of which were removed a few years ago to make room for a new building, there probably stood one that told where the first of the Fulton family in America found a sleeping-place till the "morn breaketh and the shadows flee away."

The boy, Robert Fulton, mastered his "three R's" at home and then took up his other studies at a school kept by a Quaker in a building that stood on the northeast corner of East King street and the center "Square" in Lancaster. A schoolmate of those early days wrote:

"His mother was a widow in straitened circumstances. I had a brother who was fond of painting. The Revolutionary war made it difficult to obtain materials from abroad, and the arts were at a low ebb in the country. My brother consequently prepared and mixed colors for himself, which he usually displayed on mussel shells. His cast-off brushes and shells fell to my lot, some of which I occasionally carried to school. Fulton craved a part and I divided my treasure. He soon from this beginning so shamed my performance by his superiority, that I voluntarily surrendered the heirship of all that came into my possession. Henceforth his book was neglected and he was often severely chastised by the schoolmaster for his inatten-

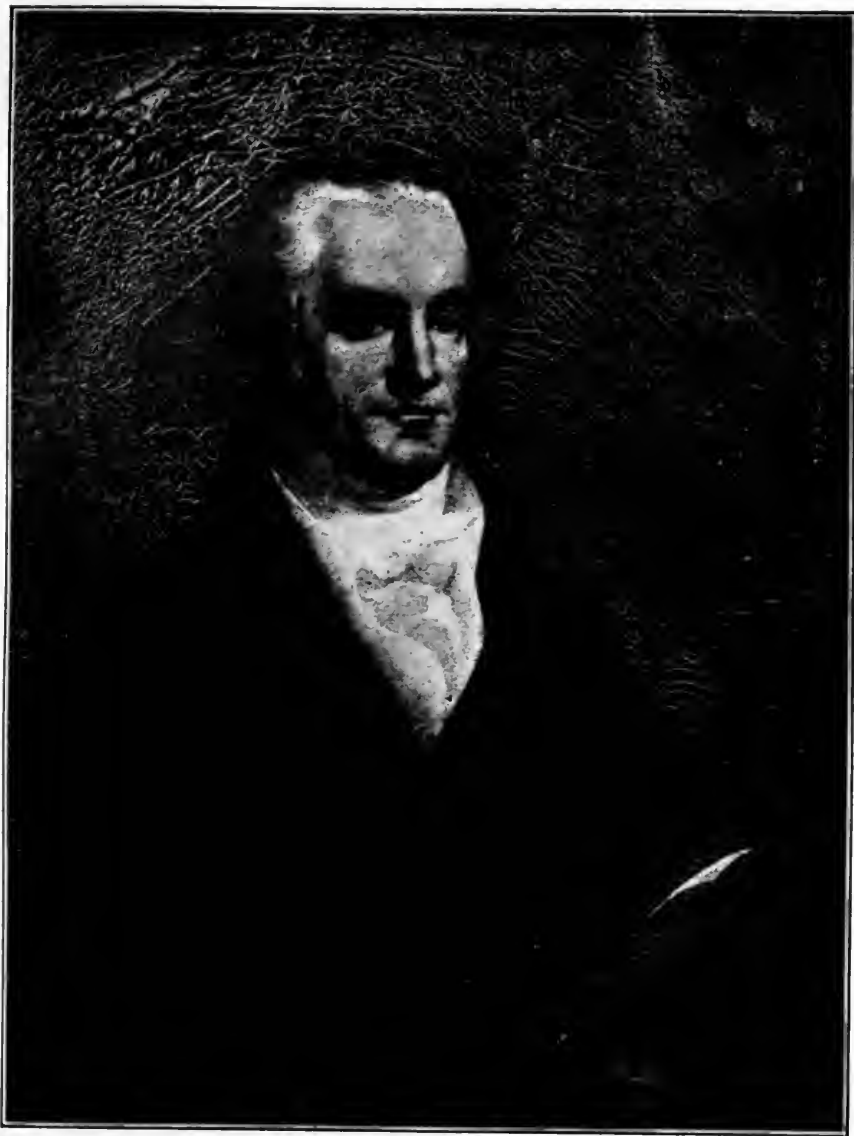

PAINTING BY ROBERT FULTON

The subject is Fulton's fellow aesthete and utilitarian, Joel Barlow the poet and diplomat who was Fulton's most intimate friend when the inventor proposed to Napoleon the power of steam as a destroyer of the navies of the world but met with rebuff—Original is now in possession of the Barlow family in New York and a replica is owned by Fulton's grandson, Robert Fulton Ludlow of Claverack, New York



1807—Centennial of Steam Navigation—1907

tion. His friends removed him to Philadelphia where he was apprenticed to a silversmith; but his mind was not in his trade and in his eighteenth year he established himself as a painter in that city."

Fulton was apprenticed to a silversmith, and for some time followed that vocation. Later he turned to miniature painting and in 1785-6 when John Fitch put his first successful steamboat on the Delaware, Fulton had a studio at the corner of Second and Walnut streets, Philadelphia.

It was while returning to Philadelphia from a visit to his mother that he met at the warm springs of Pennsylvania the friends who chanced to see some of his paintings and advised him to go to London and complete his art studies under Benjamin West, who had already gained some celebrity and was then on the way to fame. Both Fulton and West were born in the wilds of Pennsylvania, and their fathers were well acquainted.

In speaking of this beginning of American art which seems to be contemporary with American commerce, I must say that had not Fulton's abilities been turned to more material things American art would have been the richer to-day. To some extent this is also true of his friend, West, who was tainted by patronage. Unfortunately for him and for the world, West became a favorite of George III, to whom he had been presented by the Archbishop of York, and painted, to the infinite satisfaction of the king, an almost endless list of historical and classical pictures—stiff, forced and formal, each a little lower in merit than the one that had preceded it, and all marking a line of sharp retrogression from the "Departure of Regulus" to the "Fall of Wolfe." Evidence of a new start when, after the illness of the king, he was thrown again upon his own resources and was once more free to follow his own inspirations, is shown in his "Christ Healing the Sick" and his "Death on the Pale Horse," which are still valued for more than respectable coloring and clever drawing. Through the ad-

mirable foresight of Robert Fulton, who purchased several of his choicest pieces, we now have in the United States the most praiseworthy of his productions.

Fulton was received with open arms by West and for several years was as one of the family in this delightful home. West painted a portrait of his friend, Fulton, which is possibly the height of his genius as a portrait painter. A few days ago, at the home of Fulton's grandson, Robert Fulton Ludlow, I looked upon the rich canvas, and felt the full power of these two strong men.

Fulton later spent two years in Devonshire, near Exeter, where he met the Duke of Bridgewater, famous for his interest in canals, and Lord Stanhope, celebrated for his love of science, especially along mechanical lines. It is claimed by some of his biographers that Fulton at this time met James Watt, the eminent engineer. But a letter from Joel Barlow to Dr. William Thornton, which is here printed for the first time, shows that this is not so. Dr. Thornton purposed visiting England. He had written Fitch (February 21, 1794):

"Let me advise you to get no steam engine made except by Watt and Boulton and with a copper boiler without any wood round it and very strong copper. It will never be a loss, for when worn out it will sell."

He now proposed a personal visit and wrote for a letter of introduction to which he was given the following answer:

DEAR SIR:

Mr. Fulton informs me that he does not know either Mr. Watt or Mr. Boulton, that when he purchased the Steam engine he dealt with their agent in London, which I now recollect was the case.

I should suppose that no letter of recommendation to them can be necessary for you—your name and character are too well known as a mechanic and architect, as well as for general science, that it is impossible it should be unknown to them.

Yr fd

servt

J. BARLOW.

TO DOCTOR THORNTON.

1607—Ter-Centenary of American Commerce

However, Fulton had visited the works of Boulton and Watt, for in his diary, now in the possession of Mr. Robert Fulton Ludlow, his grandson, we find an entry as follows:

Feb'y the 5, 1804 travelling from London to Birmingham and back again to order the Steam Engine.....£8.0.0

Farther on we read:

Jan. 21, 1805 To Messrs Boulton Watt & Co. for cylinder and parts of the engine.....£548.0.0

March the 18th To Messes Cave and Son for copper boiler weighing 4399 lbs, at 2s. 2d. the.....£476.11.2.

There is another entry in the diary that we must include with these, all of which now appears in print for the first time, as it throws light on the debated question as to how Fulton got the engine out of England. Under the date of March 22d, 1805, he writes:

Fee at the Treasury on receiving permission to ship the Engine to America.....£2, 14s, 6d

I have found few instances in the world's work where an intense artistic temperament is almost instantaneously transformed into practical mechanics. Fulton, however, either by foresight or intuition looked into the centuries and discerned the power that was to revolutionize the earth. When twenty-nine years of age, in 1794, he obtained a patent for a double inclined plane, to be used in connection with canals, and for several years thereafter he was actively engaged in projects for the improvement of inland navigation. In 1794, he submitted to the British Society for the Promotion of Arts and Commerce a new method for sawing marble, for which the society gave him a vote of thanks and an honorary medal, and some time later he patented devices for spinning flax and for making rope. Several contrivances for digging canals and aqueducts were brought out by him at this time, besides an iron bridge built upon new lines, and thereafter he proclaimed himself a civil engineer, under which title he produced his work on canals and published sev-

eral articles in the *London Morning Star*. In 1796, he published his "Treatise on the Improvement of Canal Navigation," copies of which were sent to the governor of Pennsylvania and to General George Washington, from whom he received a very flattering acknowledgment.

With a greater civilizer in his grasp than the planet had yet seen, the young inventor naturally turned toward the center of civilization. America was a struggling, bankrupt republic, experimenting with the theory of self-government. England was occupied with problems that involved her future as an empire. France, the gathering-place of art and letters and science, dreamed of days when she would be the diadem in the crown of the world's powers—when England and America and half the civilized globe would bow to her mandates. Like many another youth before and since, Fulton went to France to introduce his improvements in canal transportation. The French people had not been long enough freed from the madness in which they had thought to dethrone God by vote, and rule Him out of His own universe, to care much more for improvements in canals than they had previously cared for steam navigation when suggested by John Fitch. But when Fulton proposed a panorama, the first that had ever been seen in Paris, he was hailed as a public benefactor, for here was something that might deepen the dimple of a smile in which could be caught the tear of a never absent though repressed sorrow.

France will be France as long as the world lasts! The same versatile, blasé, gala-day nation that Napoleon wooed—this is the France that Fulton found—a people trying to forget the cares of life, ever willing to be entertained and eager to applaud. It brought him back to his first love—Art. He knelt again at her feet and worshiped. Aesthete that he was, psychologist that he must have been,

1807—Centennial of Steam Navigation—1907

he lifted the veil and beneath it he found the tear-stains and the laughing eyes still wet with weeping.

Life among the French so impressed Fulton that he turned to the study of political economy and published a treatise addressed to "The Friends of Mankind" in which he pointed out the effect that education and internal improvements must have upon the happiness of a nation. He wished not only for a free and speedy communication between the different parts of a large country, but a universal free trade between all nations. In one of his phrases he coined into beautiful English one of the most important truths ever expressed in literature: "The liberty of the seas will be the happiness of the earth." It was about this time that he met Joel Barlow, who had but recently returned from Algeria, to which country he had been appointed by Washington in 1795 to redeem the captives taken by pirates and to negotiate a treaty of peace. Barlow was not only a diplomat but a poet. He, too, had become imbued with the French spirit and was a rollicking litterateur, especially skilful with the mighty sword of satire. Withal, Barlow was well-balanced and he was as adept with the bludgeon of Mammon as he was with the needle point of literary irony.

He had succeeded. Reaching Paris, after some successful speculations that yielded large returns, he purchased the hotel of Count Clermont de Tonnerre where he lived as was becoming to his wealth. Fulton was introduced to him and in a few weeks became a member of his household as he had formerly been a member of West's home-circle in London and for a short time returned to his art, painting easel pictures. Here were two men of congenial minds and they at once began experimenting with a machine that Fulton devised for exploding a large quantity of gun-powder under water. It was the very thing that David Bushnell, of New London, Connecticut, had proposed when scarce

through his course at Yale College, twenty years before. With Bushnell it was a success—destroying one of the tenders of the British frigate "Cerberus" as it lay in Long Island Sound, but with Fulton and Barlow it was a failure. However, when the device was more perfectly worked out, Fulton appealed to the French Directory for aid and was at first given to understand that the aid sought would be forthcoming but later he was told that his plans had been totally rejected. Nothing daunted, Fulton prepared a model of his invention and when the kaleidoscope of the ever-changing French people again showed a new list of directors, he presented them with a memorial, seeking, a second time, their investigation. Another commission was appointed and after three months more of waiting Fulton was told that his plans had been again rejected.

But the hour-glass turned again. Napoleon was made First Consul. It was on the eve of his great dream when his mighty hand should sway the peoples of the earth and he should sit enthroned over the Old World with a New World as plaything to be tossed about at will and ultimately proclaimed as his own. Sporting with thrones and powers as a child plays with the petals of a broken flower, all men were to him but puppets and if this young visionist from the coveted America could be but an atom in the Great Scheme, Napoleon would give him heed. Fulton at once waited upon him and so won his interest that a committee was appointed from the Academy of Sciences to examine into the merits of the new invention. Upon their report a grant was made by which Fulton was enabled to put some of his ideas into actual practice.

In the spring of 1801 Fulton repaired to Brest where he experimented with a diving boat constructed the preceding winter, a crude affair as all first attempts must necessarily be, but the demonstration was pronounced a

1807—Ter-Centenary of American Commerce

success and was so reported by the committee appointed to follow his experiments. Through July and August Fulton continued his work in a vain hope that some of the English ships just off the coast would come in near enough to allow him to show exactly what could be done in the way of destruction by a submarine mine. The sailing of the fleet carried with it Fulton's opportunity and the French officials refused to make any further advances for such a mode of warfare.

The British government had some intimation as to what Fulton was doing, and at the suggestion of the Earl of Stanhope, it was decided to induce him to leave France, if possible, and continue his investigations and experiments in England. The correspondence that followed had its desired effect and in May, 1804, Fulton arrived in London and was at once given an audience with Mr. Pitt and Lord Melville. Both men saw the value of such an engine of destruction and when, on October 15, 1805, Fulton blew up the strongly-built Danish brig of two hundred tons that had been provided for the occasion, there was no longer any question as to its possibilities. But the British government had no real intention of adopting his plans, it was rather a ruse to keep him from the service of France and when the purpose had fulfilled itself, Fulton was quietly allowed to drop out of their consideration. Here was a youth with a knowledge of a power that could cause the rise and fall of nations—a knowledge shared by other young Americans—but neither the foresight of a Napoleon nor the shrewdness of a Nelson could comprehend it.

Some of the correspondence that had passed between Fulton and the representatives of the French government seems to show that it was Fulton's plan to build a powerful steam-propelled boat that could tow barges upon which the French army could be loaded and ferried across the channel.

A still, calm night was to be chosen, when the fleet of Nelson would be powerless to interfere, and the invincible French were to land on the shores of England. Had such a project met with approval all the history of the last hundred years might have been written differently. If it had been possible, as is often claimed by Fulton biographers, for Napoleon to have seen from the isle of his banishment a steamship sailing against both wind and wave he must have realized the folly that led him to listen to the opinions of others and thrust from him the service of that potent force by which he might have changed the face of the then known world. But why deal in conjectures? The "Savannah" did not cross the ocean till 1819 and the "Royal William" did not sail upon her trans-Atlantic trip till more than twelve years had passed and it was seven years more before any other steamcraft ventured far from shore. It is not at all probable then, Fulton's biographers to the contrary, that Napoleon in his wisdom ever saw a steamship, for death came to bring him release in 1822, years before a steamship went near to the isle of St. Helena.

While Fulton was absorbed in the science of dynamics he turned always to Art for his recreation.

Before Fulton left France it had been decided that Barlow would bring out a new edition of his "Vision of Columbus" and that it should be illustrated with drawings suggested and superintended by Fulton. Barlow did not remain long in Paris and soon after his return to this country, the poem, enlarged and re-christened "The Columbiad," was brought out in sumptuous style in Philadelphia—a quarto with plates designed by the English artist, Smuke, and executed by the best English engravers. The subjects for the designs were all pointed out by Fulton, who had the costly engravings made at his own expense. A painting of Barlow by Fulton added to the value of the work.



BIRTHPLACE OF ROBERT FULTON

Fulton Farm in Little Britain township in the dense forests of Pennsylvania, where, in 1756, the lad was born who was destined to revolutionize the world's trade—From an old print designed by Reigart, one of Fulton's biographers



FULTON'S GIFT TO HIS MOTHER

Homestead in Washington County, Pennsylvania, which Fulton purchased for his widowed mother and sisters on his twenty-first birthday with money he had accumulated in Philadelphia by painting portraits and landscapes, and making drawings of machinery

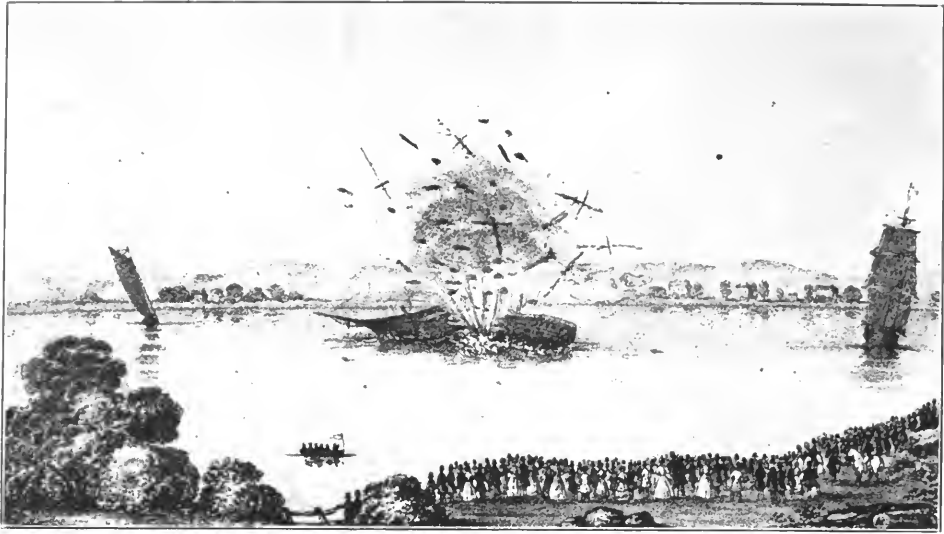

TO DESTROY THE NAVIES OF THE WORLD

When the European Continent was under the spell of the Great Napoleon, the young Fulton devised a torpedo which would annihilate the fleet of the enemy— In 1805 he demonstrated its possibilities by blowing up a strongly-built Danish brig—From an old print

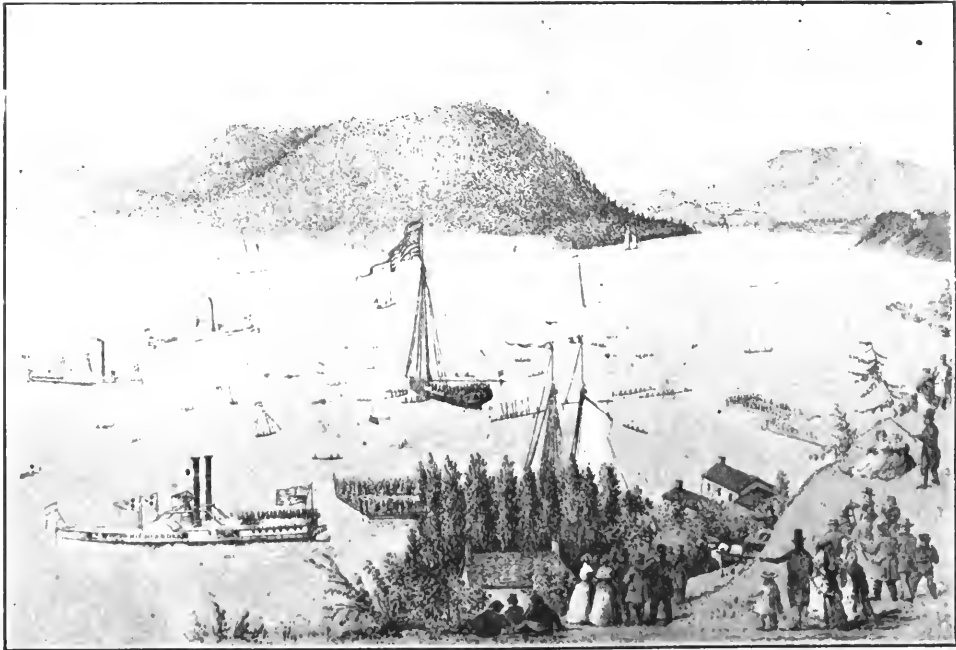

EARLY DAYS ON THE HUDSON RIVER

Society gathered near Peekskill to witness the shell-boat regattas which have since been adopted by American Unversitles and have become annual events in this country—This old print by Whitefield shows the first steamboats on the gala course

1807—Centennial of Steam Navigation—1907

This painting is now in possession of the Barlow family in New York city and a replica is owned by Fulton's grandson at Claverack, New York. From Fulton's will it is seen that the engravings and the press-work cost \$5,000, mention of which he necessarily makes in resigning all his property rights in the production to the widow of his friend who survived her husband some six years. The will also disposes of his valuable collection of paintings, including West's "Ophelia" and "King Lear," which are now in the Boston Athenæum.

The arrival of Chancellor Livingston in Paris, 1802, as Minister of the United States, turned Fulton's interests toward steamboat building, to which he had before given but little if any thought. Chancellor Livingston had sailed from New York to Greenwich upon Samuel Morey's steamboat on Long Island Sound and was on the boat that John Fitch sailed about the Collect Pond, where the Tombs Prison and adjacent buildings now stand, using both paddle-wheels and screw-propeller, and besides this had spent no little money and given no small share of his time to experimenting with a horizontal wheel under the bottom of a boat, an Englishman named Nesbit co-operating, so that he was full of enthusiasm on the subject. The plans were all worked out together and in 1802 Fulton left Paris for the village of Plombières, through which there runs a little stream, and continued his experiments which resulted in the building during the next winter of a steamboat. Just as it was proposed to test the strange thing, one of the watchmen who had been left to guard it, came rushing in with the news that she had broken in two in the middle and sunk to the bottom of the stream. Nothing daunted Fulton began at once upon a new hull and within a few weeks he addressed a letter to the French National Institute, inviting them to witness a trial of his boat and this time the trial proved to be a success. It is hard to see why Fulton,

after his trial of a boat at Plombières built on the lines of other boats, should have adopted the crude wedge-shape hull that he ordered for the "Clermont." It is also hard to understand why John Fitch, after having used the paddle-wheels suspended over the sides of a boat, should have given away to the arguments of others and incorporated a series of swinging paddles along the sides as a method of propulsion.

It is because of this anticipatory steamboat that the French people are having now at Bordeaux a Fulton centennial to which the maritime interests of the world have contributed, our own government sending models of early boats.

Barlow wrote to Fulton while he was at Plombières:

. . . "I had a great talk with Livingston. He says he is perfectly satisfied with your experiments and calculations, but is always suspicious that the engine beating up and down will break the boat to pieces. He seems to be for trying the horizontal cylinder, or for returning to his mercurial engine. I see his mind is not settled, and he promises now to write you, which he says he should have done long ago, but he thought you were to be back every fortnight. He thinks the scale you talk of going on is much too large, and especially that part which respects the money. You converted him as to the preference of the wheels above all other modes, but he says they cannot be patented in America because a man (I forget his name) has proposed the same thing there. You will soon get his letter. Parker is highly gratified with your experiments; he wishes, however, something further to remove his doubts—about keeping the proportions and as to the loss of power in different velocities. He wishes to have another *barrelier* made, four times as strong as this or thereabouts, to see whether the proportional velocity would be the same when moving by the paddles as when moving by the fixture on shore. I should like to see this too. If you desire it, I can take this *barrelier* to Cala and see whether he can make another of the same volume four times as strong, and know what it will cost. The relative velocities can be tried in Perrier's pond on the hill."

In another letter to Fulton Barlow wrote that he had just visited the National Depot of Machines and had

1607—Ter-Centenary of American Commerce

seen there the model of a new steam-boat. Continuing, he says:

"In all its parts and principals a very elegant model. It contains your wheel-oars precisely as you have placed them except that it has four wheels on each side to guide round the endless chain instead of two. The two upper wheels seem to be only to support the chain; perhaps it is an improvement. The model of the steam-engine is in its place, with a wooden boiler, cylinder placed horizontal, everything complete. I never saw a neater model. It belongs to a company at Lyons, who got out a patent three months ago. *I shall say nothing to Livingston about this model.*"

It became apparent to Fulton that the center of civilization was changing, that America was to be the pivot rather than the Old World nations. Invention was receiving the patronage in America while France and England were indifferent to mechanical pursuits. America was in itself an innovation. Americans were originators and disdained imitation of the older civilization. It was a new land with new ideas and new impulses. Fulton realized that the great future of invention was in the hands of the western civilization; that it was a world of opportunity.

Having demonstrated to his own satisfaction, and to the satisfaction of both Chancellor Livingston and Joel Barlow, that a steamboat could be so built as to be usable, Fulton was anxious to get back to his own land and claim the benefits given to Chancellor Livingston by the legislature of New York; he accordingly left France for England where he was to order the engine for a boat that should be built at once for the Hudson. Barlow wrote him while yet at Plombieres:

"Your reasoning is perfectly right about inventions and the spirit of the patent laws, and I have no doubt it may be secured in America. . . . My project would be that you should pass directly over to England, *silent and steady*, make Chapinan construct an engine of twelve inches, while you are building a boat of a proportionate size. Make the experiments on that scale, *all quiet and quick*. If it answers, put the machinery on board a vessel and go directly to New York (ordering another engine as large as you please to follow you), then secure your patent and begin your opera-

tion, first small and then large. I think I will find you the funds without any noise for the first operation in England, and if it promises well you will get as many funds and friends in America as you want. I should suggest a small operation first, for several reasons: it can be made without noise. There must be imperfections in the first trial which you can remedy without disgrace if done without noise; you can easier find funds for a small experiment, etc. . . . I have talked with P. on your observations about great boats with merchandise."

In September, Fulton, then in London, wrote to Barlow who had sailed for America, November 2, 1804, and arrived in New York after a passage of fifty-two days (Livingston following soon after), that he was about ready to start for America, stating that he had an income of £500 sterling a year, with a steam engine and pictures worth £2000; and in October, 1806, he found shipping by the way of Halifax. While the ship on which he was a passenger lay at the dock there Fulton painted the portraits of some natives who crowded about for barter. These pictures are also now in the possession of his grandson at Claverack, New York, whose home is a veritable Fulton museum.

Fulton went at once to Kalorama, the home of Joel Barlow, near Washington, and began experimenting with a small engine which he had brought with him from England on the waters of Rock Creek, at a point designated now by a government memorial, with different shapes and sizes of wooden blocks to determine just what shape and what proportions would offer the least resistance when drawn through the water. The data of Bouyfoy was used in these experiments and was included later by Fulton in his application for a patent.

It was from Kalorama that Fulton wrote to Dr. William Thornton the letter which is here produced for the first time in fac-simile questioning the possibility of ever building a steamboat that could travel six miles an hour, although in one of his letters to

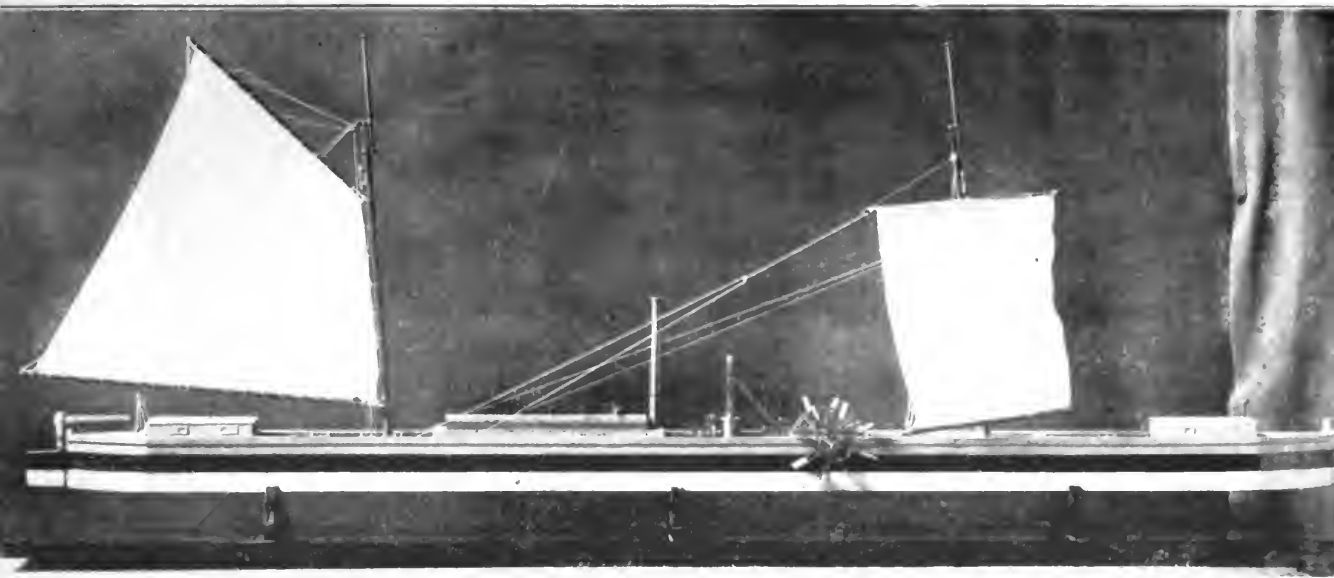

FIRST STEAMBOAT IN THE WORLD TO ESTABLISH PERMANENT TRAFFIC—Model of the "Clermont" in the National Museum at Washington showing a craft totally dissimilar to the accepted illustrations of this historic vessel—This model repudiates the prints in nearly all the histories of steam navigation but is absolutely correct according to the descriptions left by Fulton and his colleagues—This reproduction is from a plate loaned by the courtesy of Samuel Ward Stanton, an authority on marine architecture



COMPASS USED BY PILOT ACKER ON THE "CLERMONT" IN 1807—It came into the possession of Christian Cooper through Mrs. Acker and was presented by the latter, April 22nd, 1891, to Robert Fulton Ludlow, grandson of inventor of the "Clermont"—The compass bears the name of its maker, John H. Wheeler

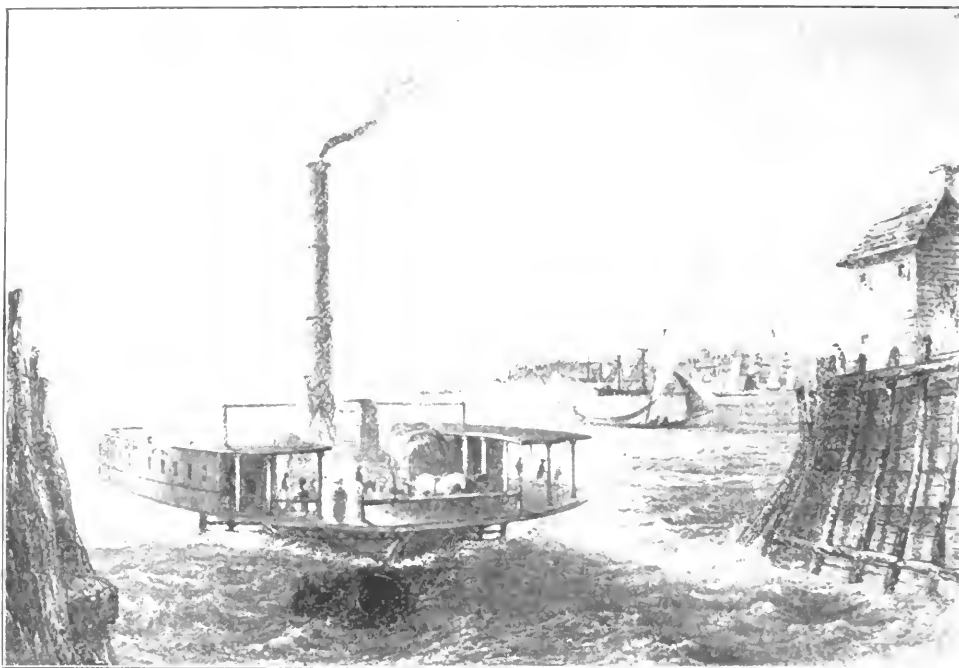

FIRST STEAM FERRIES IN WATERS OF NEW YORK
The "Brooklyn" built after plans by Robert Fulton and running across the East River



HARBOR OF AMERICA'S METROPOLIS ABOUT 1807
Old print—A remarkable contrast with the scenes about New York to-day



ALONG THE AMERICAN RHINE THE HISTORIC HUDSON
Old Engraving of beautiful waterway through which the "Clermont" sailed in 1807

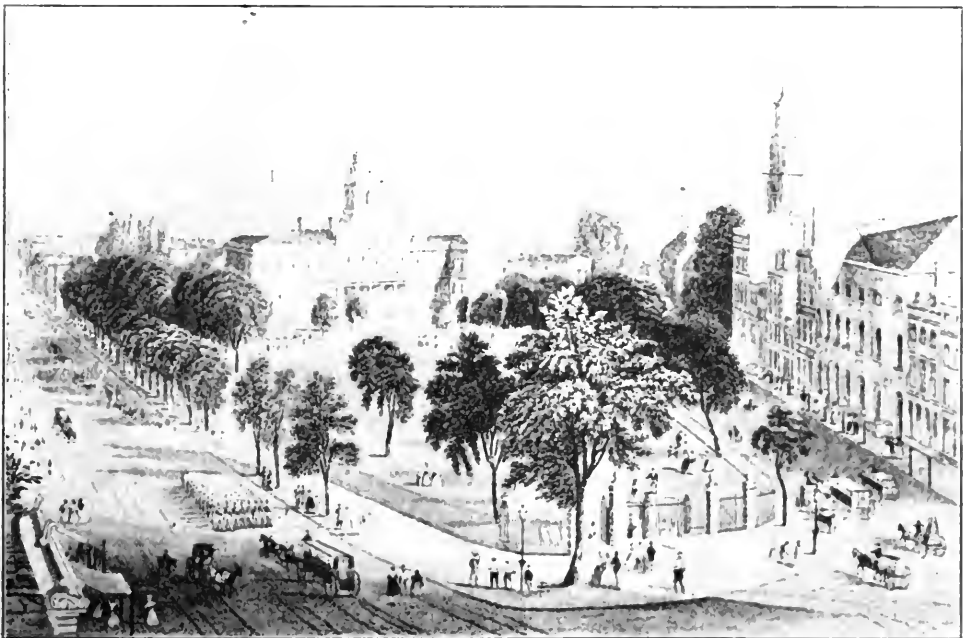

OLD NEW YORK AS ROBERT FULTON KNEW IT
Rare Engraving of Broadway at City Hall Park about one hundred years ago

STEAM BOAT RARITAN

Designed by Robert Fulton

1808

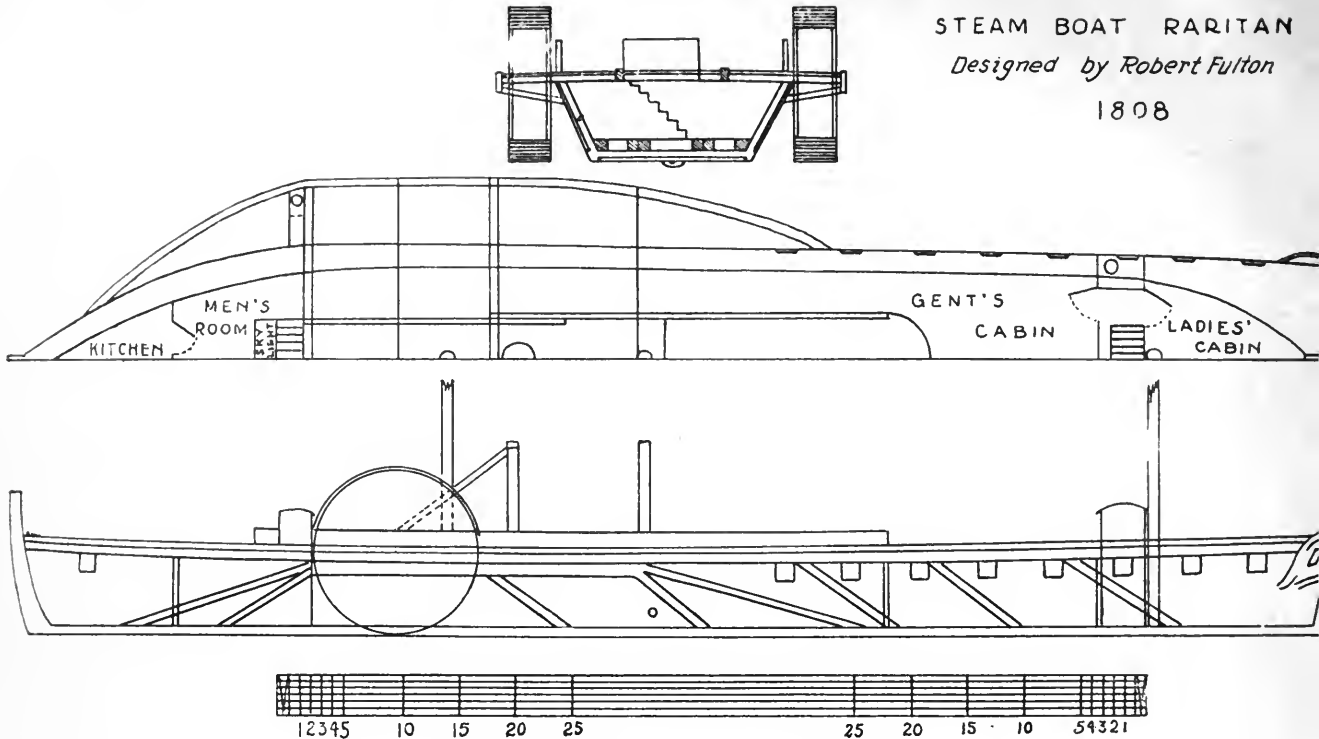

Model in the National Museum at Washington

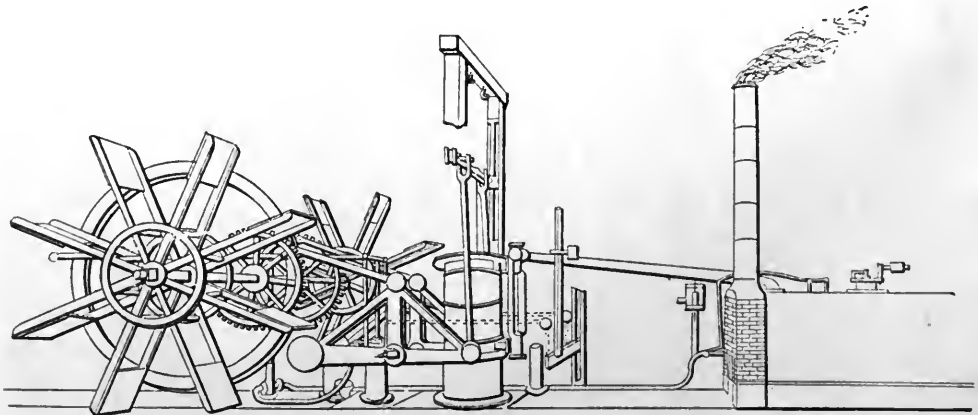

Model of the engine of the "Clermont" of 1807
Now in National Museum at Washington
Plates loaned by the Nautical Gazette

1807—Centennial of Steam Navigation—1907

Barlow while they were in France, he had predicted a speed of sixteen miles an hour, to which Barlow had answered: "I see without consulting Parker you are mad."

All along historians have said that Chancellor Livingston was the pocket-book of the enterprise. What if it should turn out that the money that went into the "Clermont" came from Barlow instead?

I merely give this as a hint. History has done more strange things and not the strangest is its inclination to give credit where credit does not belong and to obstinately refuse to give credit where credit does belong. I might mention a hundred instances, and it is a pleasure to find that many of the wrongs are being righted in the pages of this journal.

The engine for the proposed boat lay six months in the Custom House till the necessary money could be gotten together to pay what charges had been made against it, and during this time Fulton endeavored to lessen his share of the burden by offering one-third of the rights in the boat for a proportionate contribution to the expense. It was generally known that this offer was made but no one was willing to put any money into such a fool undertaking.

The difficulties with which Fulton contended do not speak well for the far-sightedness of capital. As a promoter he had many of the dire experiences of his predecessor, John Fitch. Fulton, however, was a promoter, while Fitch was but an inventor with a characteristic incapacity for organization. A few years ago I heard an anecdote regarding Fulton which later appeared in the *New York Times*. It was told by an old gentleman who was born in the first decade of the first century of steam navigation which is about to be celebrated. He said:

"My father and Fulton were intimate. Fulton was in the habit of coming to see my father, and, having steamboat on the brain, he probably talked my father, John McKesson, to death. It was always end-

less chains or something or other. My father was a patient listener, and that's a talent. One day during office hours Fulton came to see my father.

"'John,' said he, 'I have got it sure. I can make her go.'

"'I am too busy to listen to you now, Fulton. I tell you what you do, come round to my house to-night.'

"'I can't,' said Fulton. 'What I want to see you about is this: I must have \$1,000.'

"'Well, I have n't got it to give you. But anyhow, come to the house all the same. You can take tea with us. Then you can talk with me up to ten o'clock at night; then if you are not through I shall go to sleep. I always go to bed at ten.'

"Fulton seemed to hesitate for a while, and at last said he would come. Fulton did come round, and took tea with father. Fulton told him about the paddle-wheel. Father thought that a paddle-wheel would never do. You see, in those times they were cocksure that the power used to lift up the water by the wheel would about neutralize the propelling force. Ha! ha! those old fellows were smart. We always are in our generation.

"'Well,' father said, 'Robert Fulton, your wheel is no good. It would never work. You talk about making the boat go four miles an hour! That's an unheard of speed. No, sir. With a wheel on your boat she'd stand stock still.'

"Then Robert Fulton argued it out with father, and ten o'clock came, and father was getting sleepy. Just then maybe Fulton got more excited, or father more attentive, and it was eleven o'clock and they were talking over it still.

"'It is time for you to go home, Robert,' said my father, 'unless you would like to have a bed here, and you might as well do that.'

"'If I do,' answered Fulton, 'I only adjourn the talk until to-morrow, for you must get me the \$1,000.' Maybe Fulton buttonholed father before breakfast. Anyhow, Fulton's persuasive powers overcame father's doubts, and he agreed that he would do his best to raise the \$1,000 for Fulton. Right after breakfast father went out, and the first man he met was Robert Lenox. 'See here, Mr. Lenox,' said father, 'I want some money from you to help one of Fulton's schemes. You may not believe it ever will be done, but the man fancies that he can make a boat go four miles an hour. I think he intends using steam, and a wheel, or something. I am going to let him have \$100. Would you mind putting down your name for the same sum?'

"'It seems quite preposterous,' said Mr. Lenox to my father, 'and I have no reason to believe that Mr. Fulton's boat will ever accomplish what he thinks it will. Still, if

1607—Ter-Centenary of American Commerce

your name is down, you may let him have \$100 from me.'

"Then," said my father, 'I will write down "Robert Lenox, \$100."'

"No, no," answered Mr. Lenox, 'just put down the \$100 with no name to it, because I shouldn't like the people who come after me to learn that I was such a dunce as to think that Fulton or anybody else ever could make a boat go with steam or wheels four miles an hour.'

"That's the story my father told me. You never can exactly tell what does come from an invention. I wonder what Fulton would have to say could he learn how those rocks at Hell Gate had to be blown up because they bothered that fleet of steamers which had to pass there every day."

The hull of the "Clermont," which was ordered soon afterward, differing from everything that was ever called a boat, was built by Charles Brownne whose ship-yard was at Corlears Hook on the East River. Two hundred years had gone by since the first boat of any size built in the New World was launched at Popham Beach, Maine, at the mouth of the Kennebec, of which event the people of that state are so proud, and justly, that they are now making preparations to celebrate its three hundredth anniversary. This first boat was named the "Virginia" and the materials for its construction were shipped over from England with the colonists on "The Gift of God" and "The Mary and John," sailing from Plymouth, England, June 1, 1607, and arriving August 19 of the same year. Work was begun on the boat the next day after the arrival of the settlers. The builder was a Mr. Digby, a master shipbuilder of London. The launching took place the following spring. The boat was a pinnacle of thirty tons, navigated with oars and two small sails. Light of draft and easy to handle it was of great service to the colonists in exploring the neighboring waterways and trading with the Indians. Besides its many expeditions of this kind it made two trips across the ocean, going to England with the colonists when they abandoned the settlement in the autumn of 1608, and returning with Sir George

Somers' expedition in 1609. This little craft which seems insignificant to us in this day of floating palaces and colossal freighters, compared favorably in size with the vessels built in that day.

The launching of the "Clermont," just one hundred years ago this summer, was the third important event in the annals of the American Republic. The Declaration of Independence proclaimed the birth of a new people; the Constitution established a new political power; the inauguration of steam navigation threw wide open the gates of the world and linked the races and climates and products of the earth into a great and practical whole. And yet it hardly created honorable attention. It aroused nothing more than curiosity. Men of acknowledged business-standing looked upon it as the awe-inspiring feat of some foolhardy adventurer who prized notoriety as dearer to him than the safety of life. The only ones who seemed to have noticed the boat at all were the upriver packet-men who, as if under some premonition as to what her building really meant to them, tried repeatedly to destroy her. Twice during the June following her launching Fulton wrote of this in his diary:

June 7: To the Men For Guarding the boat two nights and a day after the vessel ran against her.....\$4
June 13: Pay to the men who guard the boat.....\$20.00

I have looked through the files of the newspapers of one hundred years ago, preserved by the New York Historical Society, and in the Lenox Library, to ascertain just what impression the beginning of the world's commerce made upon the press and the public. Although the population of New York numbered upwards of eighty-three thousand and there were more than twenty papers published, half of them having daily editions, besides several weekly and monthly magazines, there is no mention of it and when the boat really began to run upon her route regularly the only account

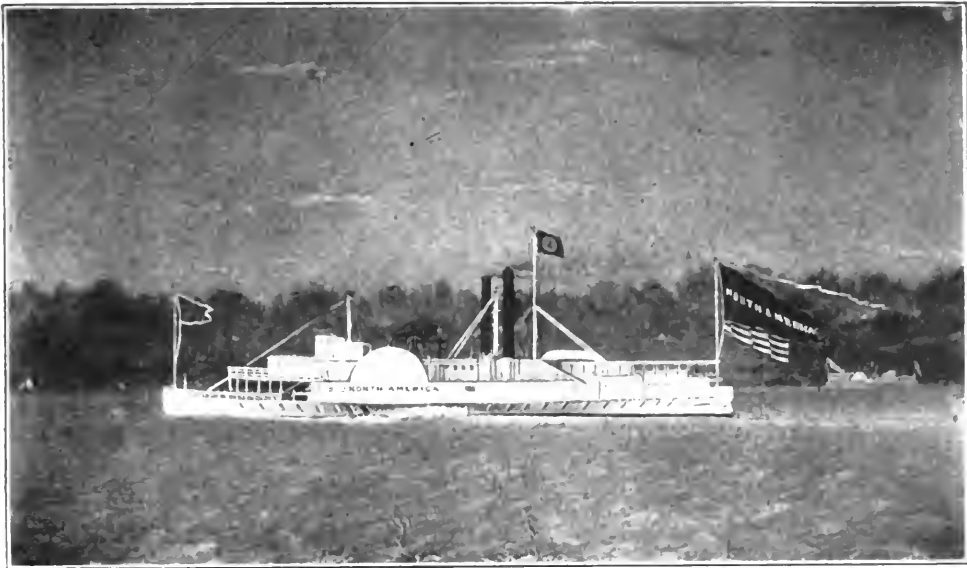

FIRST STEAMBOAT PAINTINGS IN THE WORLD

Reproductions from rare canvases by James Bard, the marine painter whose brush perpetuated the architecture of the first boat to be propelled by steam—Bard's painting of the "North American," a marvel of the Hudson River

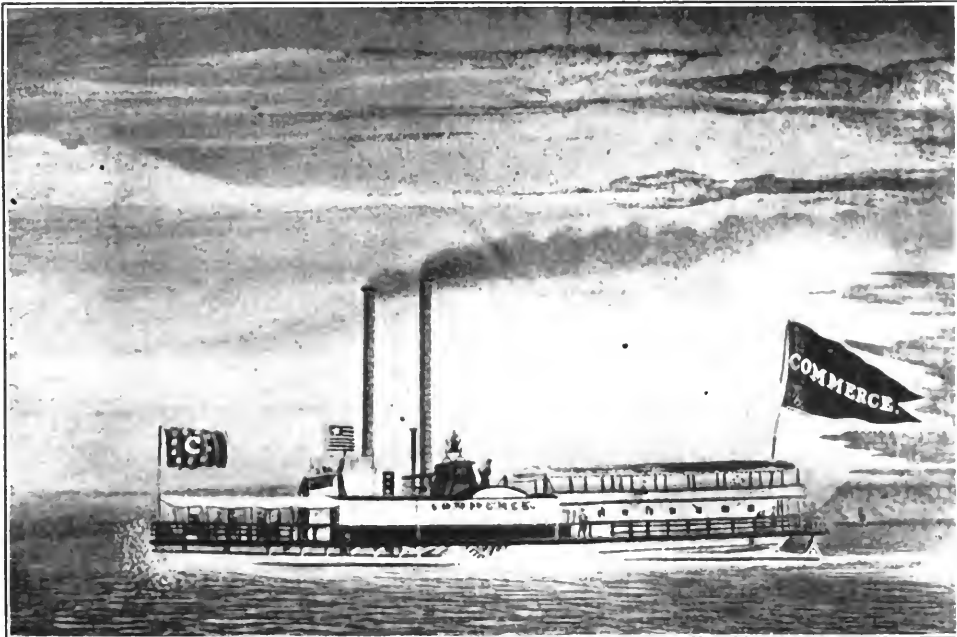

"WHY SLEEP ON THE EDGE OF A VOLCANO"

This was the advertisement introducing the "Commerce," which towed barges containing sleeping apartments for its passengers—This boat was designed for rich travelers on the Hudson who desired to avoid the danger of sleeping over steam boilers—Reproduction from canvas by James Bard and believed to be the oldest steamboat painting in the world

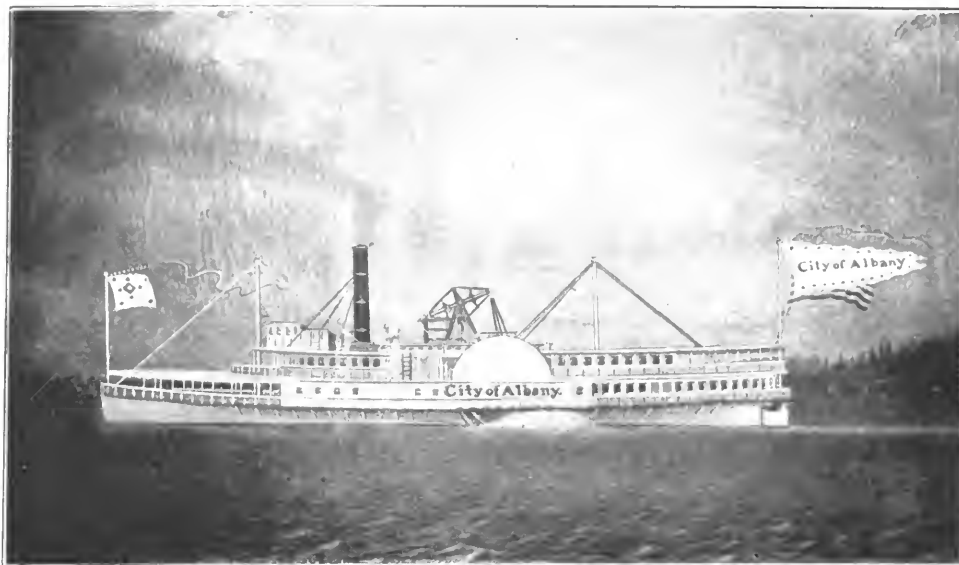

FIRST BOAT BUILT FOR HUDSON RIVER DAY LINE SERVICE

The "City of Albany" reproduced from the original Bard canvas painted for Commodore Van Sanvoord, a leading personality in the first years of steam navigation following its inauguration by Fulton

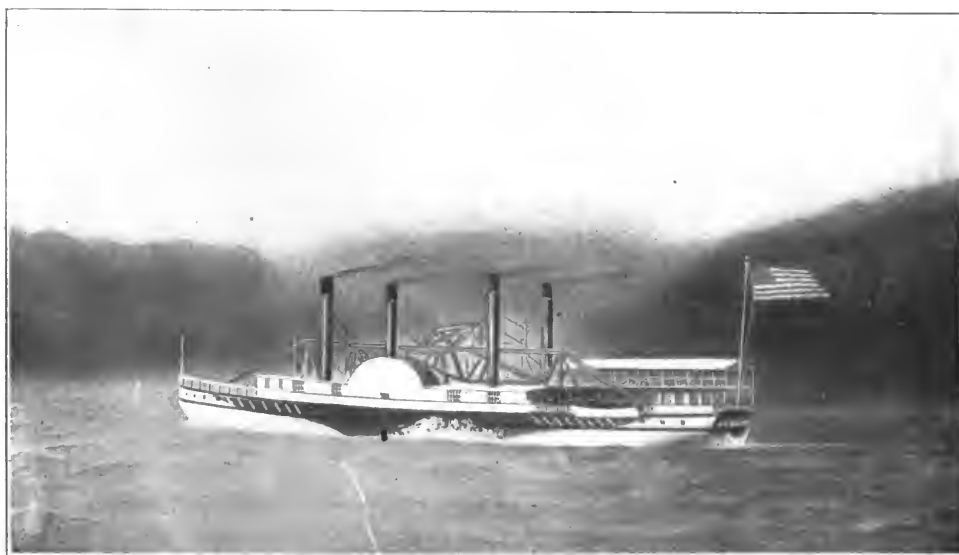

FIRST FOUR-PIPE STEAMBOAT IN THE WORLD

The "Champlain" of 1828 from rare canvas owned by Captain Roe of Albany, New York, who for more than sixty years was a prominent figure on the Hudson river and whose family is one of the oldest in river navigation

1807—Centennial of Steam Navigation—1907

given of her, or of her performances, is to be found in the paid advertisements of the company or in personal letters written either by Fulton himself or by friends on board.

The initial trip was made from Paulus Hook Ferry, now Barclay street (by some confounded with Paulus Hook itself, now known as Jersey City), on Monday, August 17, from a ferry-house that was but recently removed in numbered sections and set up on Starin's Glen Island in Long Island Sound. The first trip is described by Fulton in a letter to Joel Barlow and in another to the *Citizen*. In the former he said:

"My steamboat voyage to Albany and back has turned out rather more favorable than I had calculated. The distance from New York to Albany is one hundred and fifty miles: I ran it up in thirty-two hours, and down in thirty. I had a light breeze against me the whole way, both going and coming, and the voyage has been performed wholly by the power of the steam-engine. I overtook many sloops and schooners beating to windward, and parted with them as if they had been at anchor.

"The power of propelling boats by steam is now fully proved. The morning I left New York, there were not perhaps thirty persons in the city who believed that the boat would ever move one mile an hour, or be of the least utility; and while we were putting off from the wharf, which was crowded with spectators, I heard a number of sarcastic remarks. This is the way in which ignorant men compliment what they call philosophers and projectors.

"Having employed much time, money, and zeal, in accomplishing this work, it gives me, as it will you, great pleasure to see it fully answer my expectations. It will give a cheap and quick conveyance to the merchandise on the Mississippi, Missouri, and other great rivers, which are now laying open their treasures to the enterprise of our countrymen; and although the prospect of personal emolument has been some inducement to me, yet I feel infinitely more pleasure in reflecting on the immense advantage my country will derive from the invention," etc.

The letter in the *Citizen* is very little different from what he had written to Barlow:

"TO THE EDITOR OF THE 'AMERICAN CITIZEN,'

"SIR:—I arrived this afternoon, at four o'clock, in the steamboat from Albany. As the success of my experiment gives me

great hopes that such boats may be rendered of great importance to my country, to prevent erroneous opinions and give some satisfaction to the friends of useful improvements, you will have the goodness to publish the following statement of facts:

"I left New York on Monday at one o'clock, and arrived at Clermont, the seat of Chancellor Livingston, at one o'clock on Tuesday—time, twenty-four hours, distance, one hundred and ten miles. On Wednesday, I departed from the Chancellor's at nine in the morning, and arrived at Albany at five in the afternoon—distance, forty miles, time, eight hours. The sum is one hundred and fifty miles in thirty-two hours, equal to near five miles an hour.

"On Thursday, at nine o'clock in the morning, I left Albany, and arrived at the Chancellor's at six in the evening: I started from thence at seven, and arrived at New York at four in the afternoon—time, thirty hours, space run through, one hundred and fifty miles, equal to five miles an hour. Throughout my whole way, both going and returning, the wind was ahead; no advantage could be derived from my sails: the whole has, therefore, been performed by the power of the steam-engine.

"I am, sir, your obedient servant.
ROBERT FULTON."

In the correspondence of a gentleman from South Carolina there is a letter published in the *British Naval Chronicle* dated September 8, 1807, descriptive of the trip and stating that "on the nineteenth of August" he "was invited to go from Clermont to Albany on the boat which had come up in twenty-four hours from New York." Prior to this trip of the steamboat the distance covered required from four days to a full week on the sloops and packets that sailed between the two cities.

This date would agree with Fulton's account and may be accepted as correct, although there are as many dates given for the first trip as there are differing pictures of the true and accurate lines of the boat itself. I have made a life-long study of the development of steam navigation, investigating the mechanical evolution as thoroughly as the historical, and I regret the necessity of here stating that all the pictures of Fulton steamboats presented in two of his most widely accepted biographies are absolutely untrustworthy. They represent either

1607—Ter-Centenary of American Commerce

the imagination or the misunderstanding of the artist rather than anything that Fulton ever planned. I doubt if he would be able to recognize them as his own "children." It is unfortunate that these spurious pictures are used in nearly all the books that occupy positions of authority in our public libraries.

Possibly the dropping of the figure "one" before the "seven" in transcribing the account has led to the naming of "August 7" as the date of the first trip, and the careless omission of the hook from the top of the figure "seven" in transcribing some other account has led to setting the time on the "eleventh." Let us then, for the sake of posterity, settle down upon the fact that the boat left New York Monday afternoon, August 17, 1807, at one o'clock, having on board a party of invited guests, among whom was the Dean of Ripon, England, and arrived at Clermont, the home of Chancellor Livingston, Tuesday afternoon, where she remained until Wednesday morning at nine o'clock, when she left for Albany, arriving there at five o'clock, having made the longest continuous trip of any steamboat in the world. Later Fulton wrote to Chancellor Livingston:

"NEW YORK,

"SATURDAY, THE 29TH OF AUGUST, 1807.

"DEAR SIR:—On Saturday I wrote you that I arrived here on Friday at four o'clock, which made my voyage from Albany exactly thirty hours. We had a little wind on Friday morning, but no waves which produced any effect. I have been making every exertion to get off on Monday morning, but there has been much work to do—boarding all the sides, decking over the boiler and works, finishing each cabin with twelve berths to make them comfortable, and strengthening many parts of the iron work. So much to do, and the rain, which delays the caulkers, will, I fear, not let me off till Wednesday morn-

ing. Then, however, the boat will be as complete as she can be made—all strong and in good order and the men well organized, and I hope, nothing to do but to run her for six weeks or two months. The first week, that is if she starts on Wednesday, she will make one trip to Albany and back. Every succeeding week she will run three trips—that is, two to Albany and one to New York, or two to New York and one to Albany always having Sunday and four nights for rest to the crew. By carrying for the usual price there can be no doubt but the steamboat will have the preference because of the certainty and agreeable movements. I have seen the captain of the fine sloop from Hudson. He says the average of his passages have been forty-eight hours. For the steamboat it would have been thirty certain. The persons who came down with me were so much pleased that they said were she established to run periodically they never would go in any thing else. I will have her registered and every thing done which I can recollect. Every thing looks well and I have no doubt will be very productive.

"Yours truly,

"ROBERT FULTON."

It is due time that an accurate historical record be made of the "Clermont," the first steamboat in the world to enter into the trade of carrying passengers as a practical and permanent business. It is of further importance that publishers of books of educational and historical purport present accurate reproductions of the "Clermont" and this applies also to all other prints relating to the vital events of our national life.

As shown first in the *Connecticut Magazine*, the "Clermont" was a wedge-shaped boat, with two masts and no bow-sprit or figure head. According to Fulton's own statement, and certainly he knew the dimensions of his first steamboat, she was one hundred and fifty feet long, thirteen feet wide and seven feet deep. Being flat-bottomed she carried two "lee-boards" to use as adjuncts for



416 a

1807—Centennial of Steam Navigation—1907

steering when the sails were set, to prevent making leeway; the bottom was a transverse platform and moulded out with batten and nails. The shape of the bottom being thus formed, the floors of oak and spruce were placed across the bottom; the spruce floors being four by eight inches and two feet apart; the oak floors being reserved for the ends; the oak floors both sided and moulded eight inches. Her top timbers (which were of spruce, and extended from a log that formed the bridge to the deck) were sided six inches and moulded at heel, and both sided and moulded four inches at the head. Her draught of water was twenty-eight inches. She had a copper boiler weighing 4,399 pounds, entirely encased with brick, the whole being twenty feet long, seven feet deep, and eight feet wide, above which there towered a twenty-five foot chimney made of sheet iron bought of Mr. Jackson for \$26.25; her cylinder was twenty-four inches in diameter, with four feet stroke; her wheels, made of planks bought of John Cunningham for \$23.43, were fifteen feet in diameter, with eight arms; the buckets or paddles having a thirty-inch face and two feet dip; her shaft was of cast iron, four and a half inches in diameter, under the deck, and had a fly-wheel of ten feet diameter outside of the boat; the arms of the wheel extended below the bottom, and were the source of great inconvenience in shoal water.

In the *Albany Gazette* of September 2, 1807, there is an "ad" reading as follows:

"The North-River Steamboat will leave Pauler's Hook Ferry on Friday, the 4th of September, at 9 in the morning, and arrive at Albany on Saturday at 9 in the afternoon. Provisions, good berths, and accommodations are provided.

"The charge to each passenger is as follows:

To Newburg	dols. 3,	time, 14 hours.
To Poughkeepsie	" 4,	" 17 "
To Esopus	" 5,	" 20 "
To Hudson	" 5½,	" 30 "
To Albany	" 7,	" 36 "

"For places apply to William Vandervoort, No. 48 Courtlandt Street, on the corner of Greenwich Street."

The *Connecticut Herald*, of October 9, 1807, has a letter from New York, dated October 3, in which the writer says:

"Mr. Fulton's steamboat is handsomely fitted for the conveyance of passengers between this city and Albany. She left here yesterday with ninety passengers."

On October 13, 1807, a second letter is printed in which the writer states:

"Mr. Fulton's new invented steam Boat, which is fitted up in a neat style for passengers and is intended to run from New York to Albany as a packet, left here yesterday with 90 passengers, against a strong wind and tide. Notwithstanding which it was judged she moved through the water at the rate of six miles an hour. Yesterday she came in from Albany in 28 hours with 60 passengers. Quere; Would it not be well if she contract with the Post-master General to carry the mail from this city to Albany?"

A letter from John Lambert, an Englishman traveling in this country in 1807-8, has an excellent reference to the "Clermont," although the writer was slightly mixed as to the time of her building; the letter reads as follows:

"We were very desirous of seeing the construction of the steamboat, which travels at the rate of *five miles an hour against wind and tide*. It was built about four years ago, under the direction of Mr. Fulton, an American gentleman of great mechanical abilities. . . . The machine which moves her wheels is called a twenty-horse machine, or equal to the power of so many horses, and is kept in motion by steam from a copper boiler eight or ten feet in length. The wheels at either side are similar to those of water-mills, and are under cover, they are moved backward or forward, separately or together, at pleasure. (?) Her principal advantage is in calms or against head-winds. When the wind is fair, light square sails, etc., are employed to increase her speed. Her accommodations include fifty-two berths besides sofas, and are said to be equal, if not superior, to any vessel that sails on the river. They are necessarily extensive, as all the space unoccupied by the machinery is fitted up in a convenient and elegant manner. Her route between Albany and New York is a distance of 160 miles, which she performs regularly twice a week, sometimes in the

1607—Ter-Centenary of American Commerce

short period of thirty-two hours, exclusive of the detention by taking in and landing passengers. She carries from 100 to 120 people. The fare from New York to Albany is seven dollars."

This harmonizes perfectly with the description of the boat as published in the *Hudson Bee* in 1808, after the boat had undergone extensive alterations in shape and proportions. Speaking of the wheels, which at first were not covered but were later enclosed in wheel-boxes, the *Bee* says:

"They are moved backward or forward separately or together at pleasure. The machine which moves the wheels is called, we believe, a twenty horse-power machine, and is kept in motion by steam from a copper boiler 8 or 12 feet long. She sails at the rate of 4 miles an hour."

We have Fulton's personal statement as to the size of the boat (given above) and also his notations on the back of a patent specification intended for John Stevens, of Hoboken, that the bow and the stern were sharpened to angles of sixty degrees. With this agrees the statement of Professor Renwick in his letter to Captain Edward Sabine, R. A., Secretary of the Royal Society in England, which was written about 1829-30:

"Mr. Fulton, in his earlier boats, had employed flat bottoms and prows nearly of the shape of a wedge, with plane surfaces. I recollect, even at that early date, having combated the propriety of this plan in a conversation I had with him. The changes that he and his imitators subsequently made were, however, rather grounded upon the necessity of increasing the strength of the vessels by regular curves in their molds, than from a conviction of the error in the principle. The last boats built under his own directions resembled in form vessels intended to be propelled by sails, but of a small draught of water."

During the winter of 1807-8 the "Clermont" was so thoroughly changed that one would have been safe in declaring that, except in engine and purpose, she was not the same boat at all. Professor Renwick says (though he is mistaken about the name being "Clermont"):

... "The winter of 1807-8 was occupied in remodeling and rebuilding the vessel, to which the name of 'Clermont' was now

given. The guards and housings for the wheels, which had been but temporary structures, applied as their value was pointed out by experience, became solid and essential parts of the boat. For a rudder of the ordinary form, one of surface much more extended in its horizontal dimensions, was substituted. This, instead of being moved by a tiller, was acted upon by ropes applied to its extremity, and these ropes were adapted to a steering wheel, which was raised aloft towards the bow of the vessel. . . . The 'Clermont,' thus converted into a floating palace, gay with ornamental painting, gilding and polished woods, commenced her course of passages for the second year in the month of April."

So extensive were the changes made that a new registration at the custom-house was necessary. This registration, which was transcribed by Mr. John Morrison for his "History of American Steam Navigation," is as follows:

"No. 108.

"Enrollment in conformity to an Act of the Congress of the United States of America entitled 'An Act for enrolling and licensing ships or vessels to be employed in the coasting trade and fisheries, and for regulating the same.'

"Robert R. Livingston, of Clermont.

"Columbia County, State of New York, "having taken and subscribed to the oath required by the said Act and having sworn that he together with Robert Fulton of the City of New York, are citizens of the United States, and sole owners of the ship or vessel called the North River Steamboat of Clermont, whereof Samuel Wiswall is at present master, and as he hath sworn he is a citizen of the United States, and that the said ship or vessel was built in the City of New York, in the year 1807, as per enrollment 173 issued at this port on the 3d day of September, 1807, now given up, the vessel being enlarged. And Peter A. Schenck, Surveyor of the Port, having certified that the said ship or vessel has one deck and two masts, and that her length is 149 ft.; breadth, 17 ft. 11 in.; depth, 7 ft., and that she measures 182-48-95 tons. That she is a square-sterned boat, has square tuck; no quarter galleries and no figure-head. Hands and Seals, May 14, 1808."

On May 13, 1810, the *Hudson Bee*, which, more than any of the other papers of the time, seems to have followed the movements of the steamboat, says:

"The North River Steamboat (which is believed to have been the first one built on

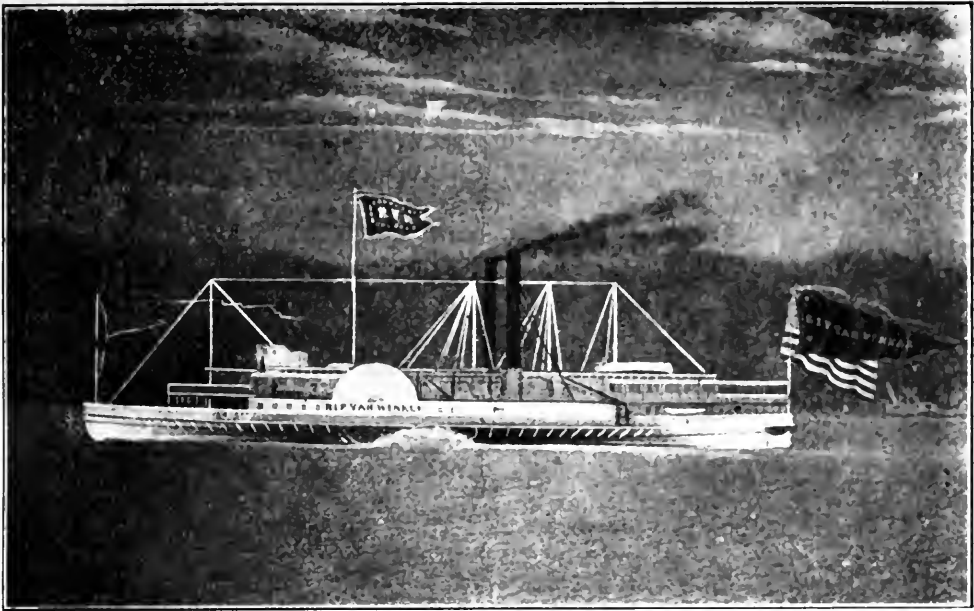

IN MEMORY OF AMERICA'S GREATEST LEGEND

The "Rip Van Winkle," an early steamboat that carried the beloved name of the sage of the Catskills and sailed the historic river made famous in American literature by Washington Irving

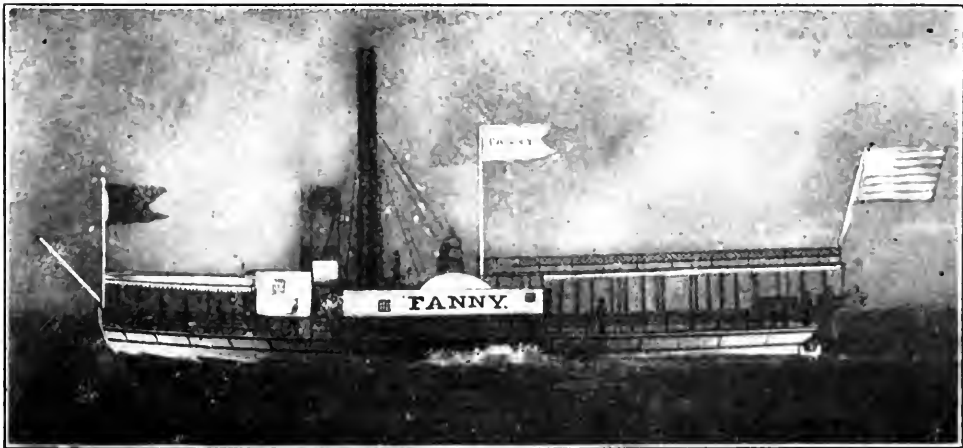

ONE OF THE FIRST STEAMBOATS TO UNDERTAKE A LONG RUN

The "Fanny," a staunch little craft under command of Captain David Tremper of Roundout, New York, one of the most popular men that ever captained a ship—In 1840, after long service, the "Fanny" was offered for sale as "built of locust and live oak and Jersey plank, thoroughly coppered"

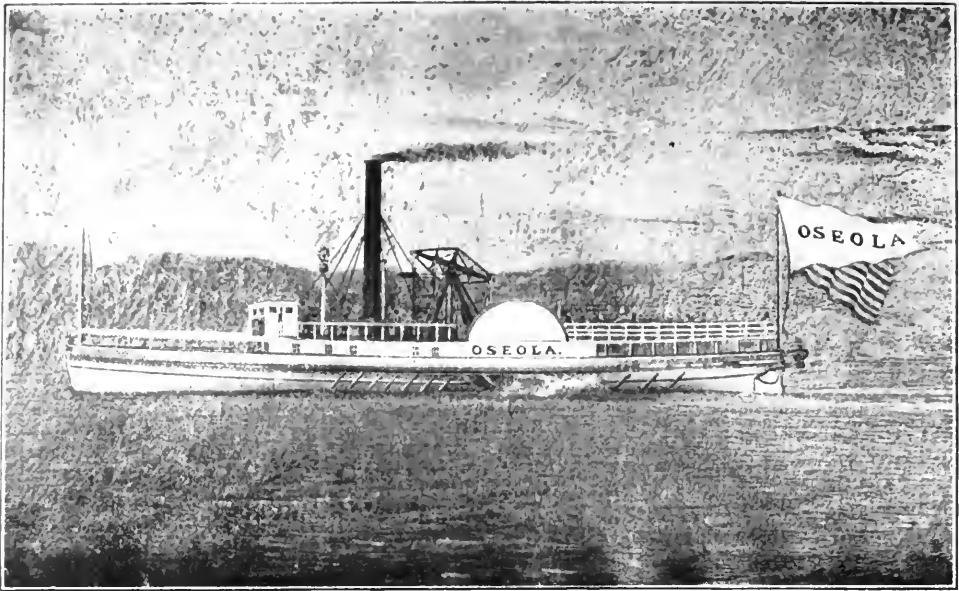

SPEEDIEST RIVER BOATS OF THE EARLY DAYS

The "Oseola," a swift little craft that ran to Poughkeepsie in 1843—Reproduction from original painting by Bard for Captain Allen Degroot, an old-time captain of the Hudson River

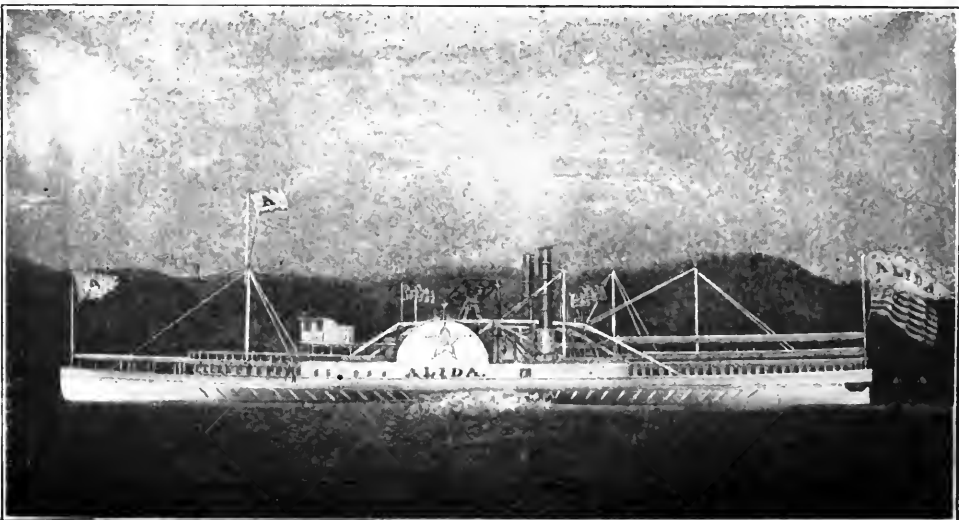

ONE OF THE MOST POPULAR STEAMBOATS OF HER TIME

The "Alida," which for many years carried distinguished travelers along the "American Rhine"—Reproduction from old canvas painted by Bard for Commodore Van Sanvoord of New York

1807—Centennial of Steam Navigation—1907

the river and has lately been known by the name of 'Clermont,' that is in the books) Captain Wiswall, arrived at this port yesterday afternoon at 5 o'clock, (Sunday, May 13, 1810) being the shortest trip she has ever made. But for the necessary detention in the way of landing passengers, it would have been performed in 19 hours."

During the fall of that year some of the citizens of Albany appealed to the press to enter their protest against the cutting of wood on the city commons for use on the steamboat without paying anything for the privilege. It is figured out in the papers that the boat carried on an average, eighty passengers each way per trip. "At seven dollars each," says the writer, "the income of the company was upwards of \$80,000 and if we deduct one-quarter for expenses, there yet remains \$60,000 profits. Isn't that enough to allow something for the wood used as fuel?"

The success of the great invention was speedily followed, January 7th, 1808, by Robert Fulton's marriage to Miss Harriet Livingston, the daughter of Walter Livingston, Esquire, of Tiviotdale, Livingston Manor. It is related that the engagement was formally announced by Chancellor Livingston, upon the deck of the "Clermont," during the interesting hours of her first successful voyage. In a graceful speech telling of the betrothal, the Chancellor prophesied that "the name of the inventor will descend to posterity as that of a benefactor to the world, and that it is not impossible that before the close of the present century, vessels might even be able to make the voyage to Europe without other motive power than steam."

When the business world saw the Fulton theory of steam navigation develop into a great and strong business enterprise, there was an immediate rush of capital into its promotion. The business world is imitative. It lacks courage for the initiative. It waits for someone else to take the risk and then jostles and grasps for a handful of the emoluments.

In 1811 an opposition line, with the "Hope" and the "Perseverance," under Captains Sherman and Bunker, was announced as ready for patronage. These boats were swifter and better in every way than the "Clermont," even after the extensive alterations that entitled her to the appellation: "floating palace, gay with ornamental painting, gilding and polished woods." Captain Bunker had just given up his sailing packet, which, on April 14, 1808, had been advertised as sailing between New York and Hudson. "This," says the *New York Press*, in a retrospective edition some years after, "was the first *packet* run on the river and as an inducement to travelers, it was announced that bed and bedding would be provided for passengers going that way. Prior to this travelers had to furnish themselves with such comforts."

The "Hope" was launched Tuesday evening, March 19, 1811, and on the trip down the river, July 27, was challenged by the "Clermont" for a race. This was the first steamboat race in history. Both boats left Albany at nine o'clock in the morning, with the "Hope" a little in the lead. This position was held until "the boats were about two miles above Hudson when the old boat, by reason of her lighter draught, took advantage of the shallow and tried to pass while the "Hope" kept to the channel. The result was a collision in which neither boat was at all injured. Captain Bartholomew on the "North River" (or "Clermont"), at once challenged the doughty Bunker to race for \$2,000 for any number of miles but the latter refused in a proper spirit. Either boat ran to New York in twenty-nine or thirty hours.

Competition was keen and the matter soon found its way into the courts where, after a long, legal wrangle, the two boats of the monopoly breakers were confiscated to the original company and destroyed at Albany in the presence of their builders.

1607—Ter-Centenary of American Commerce

At this time Fulton had only the one boat running on the Hudson, but he soon added the "Car of Neptune" and the "Paragon," both of which were in every way better than his earlier efforts—the "Raritan" was at this time on the Raritan river. These two boats had high poop decks, four feet above the main deck, and the entrance to the cabin was by the old-fashioned companionway, not by a house on deck. They each carried two masts. On the foremast was a square sail, two topsails and a jib, and on the main mast each carried a spanker and a topsail. The foremast was hinged by a heel and trunnions so that it could be lowered when the wind was ahead. When the weather was favorable everybody, passengers and crew alike, were summoned to raise the mast and hoist sail. When making a landing the pilot blew a great tin horn, some five feet long, instead of ringing a bell, the bell being used only to announce meals, which were always included in the cost of the ticket.

Writing to Captain Brink, who commanded the "North River" the second year, Fulton says:

CAPTAIN BRINK

SIR: Inclosed is the number of voyages which it is intended the boat should run this season. You may have them published in the Albany papers. As she is strongly made, and every one, except Jackson, under your command, you must insist on each one doing his duty, or turn him on shore and put another in his place. Everything must be kept in order—everything in its place, and all parts of the boat scoured and cleaned. It is not sufficient to tell men to do a thing, but stand over them and make them do it. One pair of good eyes is worth six pairs of hands in a commander. If the boat is dirty or out of order, the fault should be yours. Let no man be idle when there is the least thing to do; and move quickly.

Run no risque of any kind; when you meet or overtake vessels beating or crossing your way, always run under their stern, if there be the least doubt that you cannot clear their head by fifty yards or more.

Give the amount of receipts and expenses every week to the Chancellor.

Your Most Obedient
ROBERT FULTON.

A few items here from Fulton's diary may add to the interest of the story. Under the date of August 10, 1807, he writes:

To a North River man for the lease of an anchor.....\$2
For dishes and plates.....\$4
2 Water Casks.....\$3
and under the fifteenth, when the finishing touches were given, he enters:
Wine, sugar brandy.....\$3
Mr. Johnson, the mason \$40 (for bricking in the boiler which had been put in place by Mr. Maxwell)
To a harpoon gun \$20. Lead for Bullets \$12.

In October, among other entries, we find the following:

Richards, for table.....\$12
Jacob Winkle for mattresses.....\$64.88

As there are no original plans of the first boat, the illustration used here being a picture of the model in the National Museum in Washington, which, while agreeing as to general outline to the descriptions given to the writer by two persons who sailed upon her on the first trip up the river, gives an exaggerated idea as to the extreme length of the boat, it will be worth while to produce the plans of the "Raritan," designed by Robert Fulton in October, 1807. It will be seen that at this early date he had discovered the necessity of changing the lines of the hull, going back to those of the boat he had built in France, although he wrote to Stevens, of Hoboken, in 1808, that "the bows and stern (of a boat) should be sharp to angles of at least sixty degrees. The bow should not be full like sloops, for two reasons: that being long they cannot rise on the waves like sloops but must cut through them and being sharp the resistance is less." This would lead us to conclude, as seems to be intimated by Professor Renwick, that the change in shape was not wholly of his own deductions, but rather in deference to the opinion of others.

But new claimants were coming up all the while, or new men with old claims, and Fulton was harassed on

A CENTURY OF STEAM NAVIGATION

EARLY STEAMBOATS TO SAIL INLAND WATERS FROM NEW YORK CITY

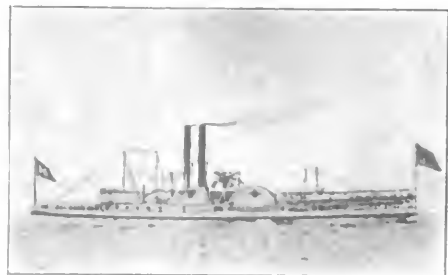
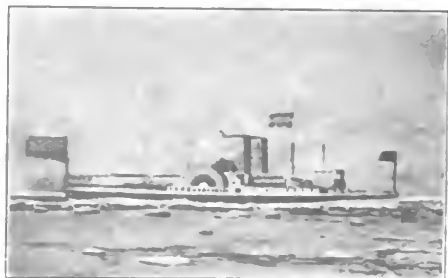
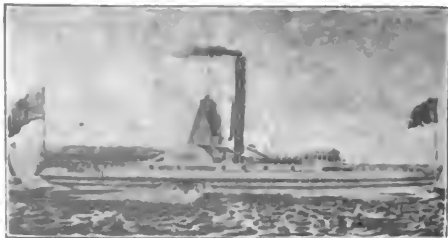
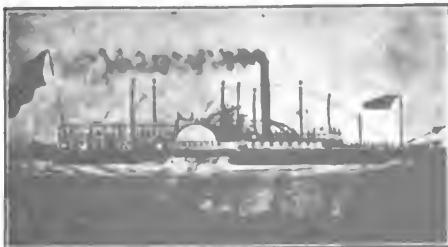

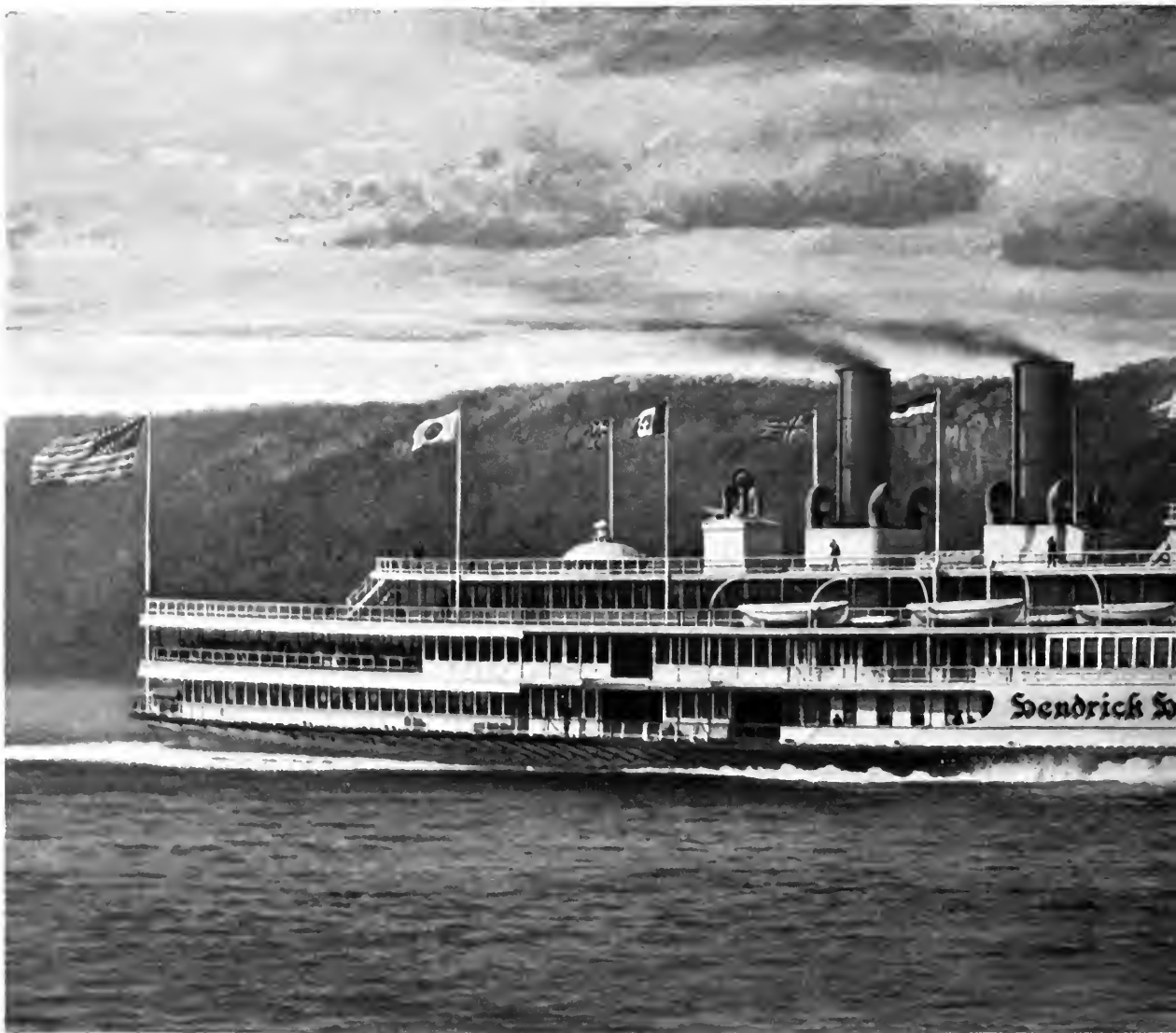

DEVELOPMENT OF THE FIRST CENTURY OF STEAM NAVIGATION
ON THE HISTORIC HUDSON — MAGNIFICENT NEW STEEL
STEAMER "HENDRICK HUDSON," PLYING BETWEEN
NEW YORK AND ALBANY ON THE HUDSON
RIVER DAY LINE AND LICENSED
TO CARRY FIVE THOUSAND
PASSENGERS

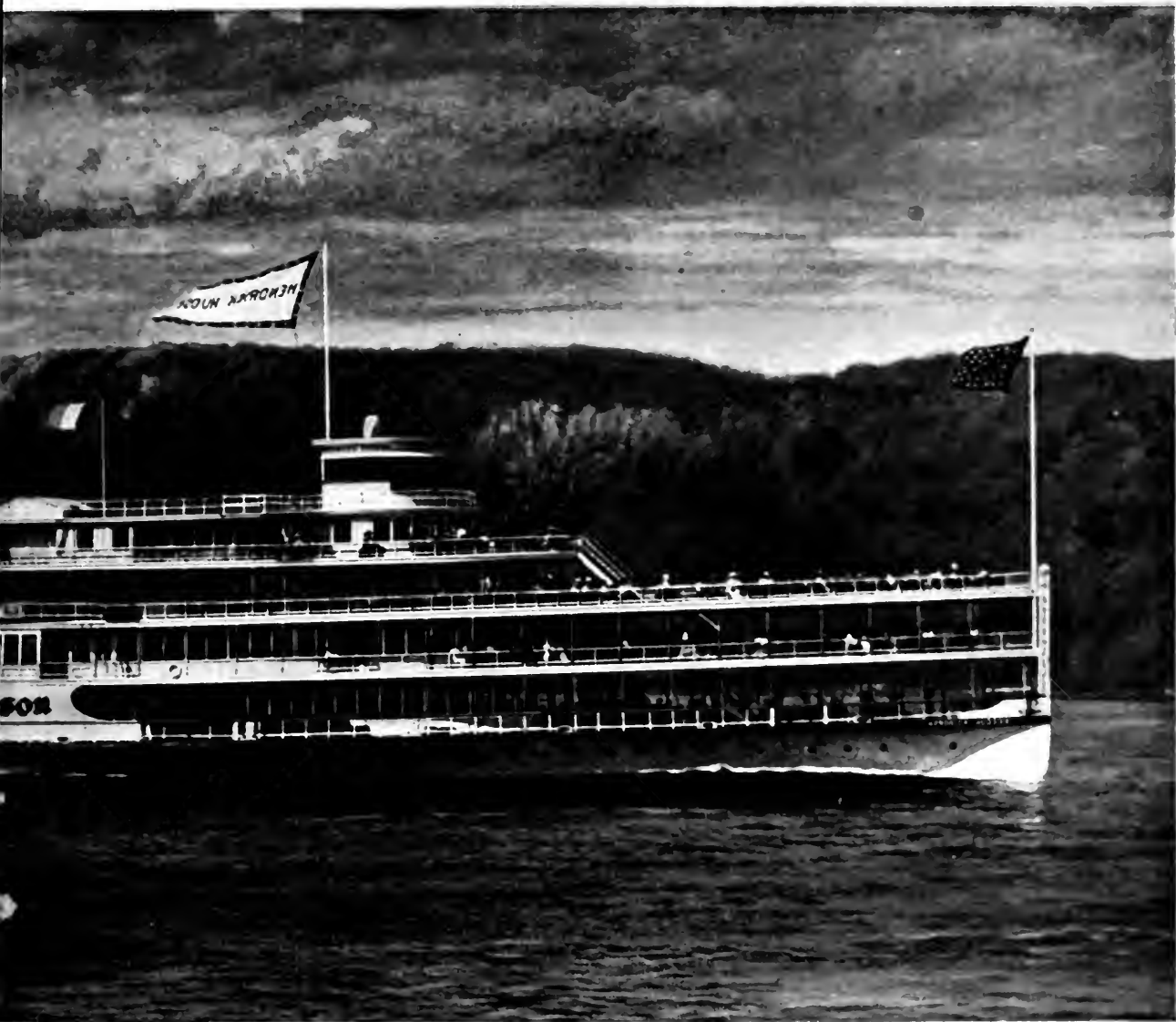

425

A CENTURY OF STEAM NAVIGATION

RARE PRINTS OF SOME OF THE FIRST STEAMBOATS ON THE HUDSON RIVER

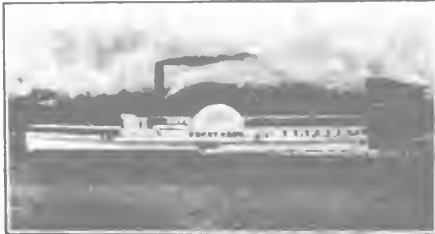
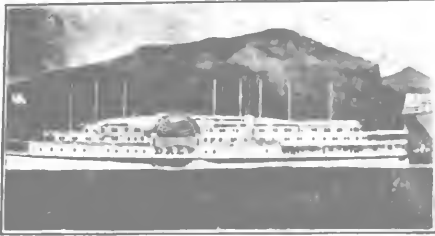

1807—Centennial of Steam Navigation—1907

every hand. In a letter to Eli Whitney, relative to securing injunctions against those who were invading his rights, he writes of his steamboats that he has

"proved their practicability and utility to the world and accommodating the public with a conveyance from New York to Albany, which for elegance, convenience and rapidity is superior to any conveyance in this globe" (April 4, 1811).

The original Fitch patents had come into the hands of Governor Ogden, of New Jersey, and a line of boats was put into operation between New York and Elizabethport, New Jersey, in defiance of Fulton's exclusive charter for navigating boats propelled by steam on any water within the limits of New York state. Ogden appealed to the legislature of the prohibiting state, but before a decision had been given by that body a compromise was made between the contending parties and Ogden was given permission to run his boats for a period of ten years under the Fulton-Livingston franchise. There was a partner, however, Thomas Gibbons, of Georgia, who later built the "Olive Branch," the "United States" and other boats, and he refused to be bound by the terms of the agreement. Counting on the testimony of Dr. William Thornton, the first United States commissioner of patents, he prepared for a fight. Thornton seems always to have been a thorn in Fulton's flesh. Writing to Monroe, Secretary of State under Madison, in relation to his patents he says:

"The case of Dr. Thornton is very simple, if he is an inventor, a genius who can live by his talents, let him do so, but while he is a Clerk in the office of the Secretary of State and paid by the public for his services, he should be forbid to deal in patents, and thereby torment patentees, involving them in vexatious suits, he should have his choice to quit the office or his pernicious practices.

My good Sir, I expect this of you.

I am, with sincere regards

ROBERT FULTON.

DECEMBER 27, 1814."

It will be remembered that during October, 1802, Dr. Thornton had pro-

posed to Major Clayborn, of Washington, that a joint concern be arranged to build steamboats that would use Thornton's boilers, Clayborn's paddle-wheels and Isaac Brigg's engines. In the following December, Fulver Skipworth received a letter in answer to one sent to Fulton in Paris, containing the following suggestion:

"My advice, therefore, is that Mr. Clayborn should make a small model, four feet long and one foot wide and about four inches deep, flat on the ends or pointed to sixty degrees. In such he can place a strong clock spring which by multiplied wheels will turn a crank and give motion to the paddles."

ROBERT FULTON.

PARIS, 12 DECEMBER, 1802."

A recollection of this letter, taken in connection with the activities of Thornton in the patents of Fitch, which seem to have come into his hands, may have led to the writing of the letter quoted above.

While Ogden was yet running the "Sea Horse," a lever-beam-engine boat, seventy-five feet long and fourteen feet wide, between New York and Elizabethtown, Gibbons put on two boats, the "Bellona" and the "Stoudinger," to run from the adjacent ferry-slip in opposition. This was the first entry of Commodore Vanderbilt into the steamboat enterprise of which he afterward became the supreme dictator. In Longworth's New York Directory for 1819 one may see the advertisement of this new line of boats bidding for patronage:

"The Old Union Line for Philadelphia via New Brunswick, Princeton, Trenton, and Bristol 35 miles land carriage. Fare through, 5 Dollars; the Vice President's [Daniel D. Tompkins] Steamboat *Nautilus*, Captain Deforest, will leave New York every day (Sundays excepted) from Whitehall Wharf, at 11 o'clock A.M. for Staten Island. From her the passengers will be received without delay into the superior and fast sailing steamboat *Bellona*, Captain *Vanderbelt*, for Brunswick; from thence—Post Chaises to Trenton, where we lodge, and arrive next morning at 9 o'clock in Philadelphia with the commodious and fast sailing steamboat *Philadelphia*, Captain Jenkins, in time to take the Old Union Line Baltimore Steamboat."

1607—Ter-Centenary of American Commerce

When Vanderbilt asked for the loan of ten dollars to purchase a boat for his proposed ferry-line, his mother made the loan conditional on his planting the hardest piece of the farm land with potatoes within a prescribed time. When the day arrived, the potatoes were all in the ground and the boy was demanding his money. Later he was asked by Gibbons to take command of the "Bellona" and after several years in this relation, when he had decided to withdraw and organize a line of his own, Gibbon insisted that he become a partner, or if not, that he should buy out his entire interest and run the line personally. The "Stoudinger" above mentioned and the "Bellona" then became his property, the former being re-named "Mouse-in-the-Mountain."

During the time of Vanderbilt the question of exclusive rights for the use of steam on the waters of New York was taken into court and upon an adverse decision was carried to the Supreme Court of the United States and the famous decision of Chief Justice Marshall was rendered by which the monopoly of seventeen years was destroyed.

The full list of steamboats enrolled at the New York customhouse between 1808, the second enrollment of the "Clermont," and 1820, covers but six vessels, viz: "North River of Clermont," May 14, 1808; "Car of Neptune," 1808, one hundred and seventy-five feet by twenty-four feet by eight feet; "Paragon," November 9, 1811, one hundred and sixty-seven feet by twenty-six feet and ten inches by seven feet and nine inches; "Fire Fly," September, 1812, eighty-one feet by fourteen feet by four feet and five inches; "Richmond," July 6, 1814, one hundred and fifty-four feet by twenty-eight feet and nine inches; "Chancellor Livingston," March 29, 1817, one hundred and fifty-seven feet by thirty-three and a half feet by ten feet. With the exception of the "Chancellor Livingston" the hulls of these vessels, which all belonged to

the North River Steamboat Company, were built by Charles Brownne. Evidently the "Fulton" and the "Raritan" must have been enrolled elsewhere. The "Fulton" was designed by Captain Bunker, who seems soon after the confiscation of the "Hope" and the "Perseverance" to have come into the employ of the North River Steamboat Company, and was looked upon by Fulton almost as incredulously as the people of 1807 had looked upon his strange craft. More than a hundred times he reiterated to Cadwallar Colden, whose entire fortune was involved in her building, the lines being drawn by Elihu Bunker who had full authority as to the arrangement of every little detail, that the boat would be a total failure. (See Doc. 21, House of Representatives, twenty-fifth session, page 104.) When she finally proved to be a success the name of "Fulton" was painted across the stern and a bust in his honor was carried as a figure-head at the bow.

For the "Raritan" there are signed plans by Fulton and a letter as follows:

"As you will have more and greater waves than the North River boat, the wheel guards must be so constructed that the head of the wave shall not strike under them as here delineated; they are 4 ft. from the water; AA, keelsons for the boiler, 8 ft. 6 in. from outside to outside; BB, keelsons for the machinery, 7 ft. from outside to outside; C, hatchway to let in the boilers, 8 ft. 4 in. wide, 21 ft. long. See Figure the 1st.

"ROBT. FULTON.

"John R. Livingston, Esq., Oct. 22, 1807."

The "Chancellor Livingston" was built from designs by Stoudinger, who succeeded Fulton as engineer of the first steam frigate-of-war, after the death of the latter in 1815. Fulton had been attending court at Trenton in reference to his claims as the original inventor of steamboats and in returning to his home at No. 1 State street, New York city, contracted a severe cold from which he died within a few days.

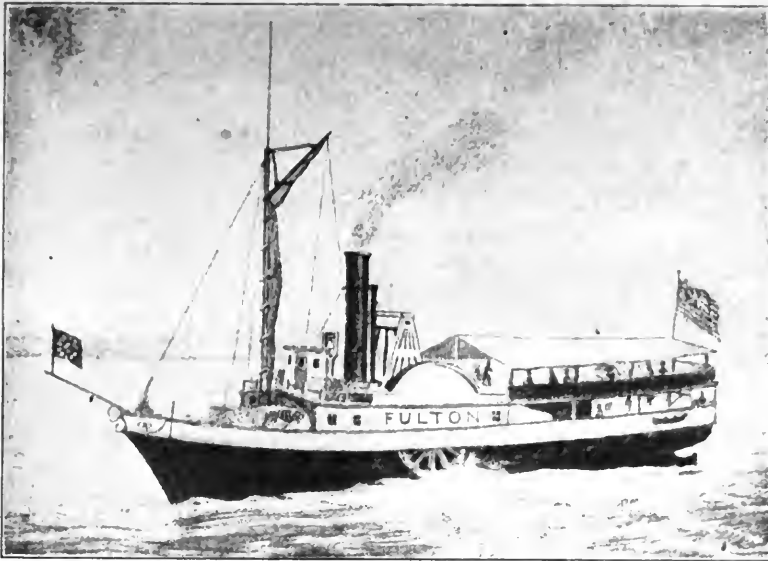

FORERUNNER OF COMFORT IN TRAVEL BY WATER

The "Fulton" of 1814, the first scheduled steamboat on Long Island Sound—At her bow she carried a bust of Fulton and with flags flying she steamed out of New York, applauded by the onlookers

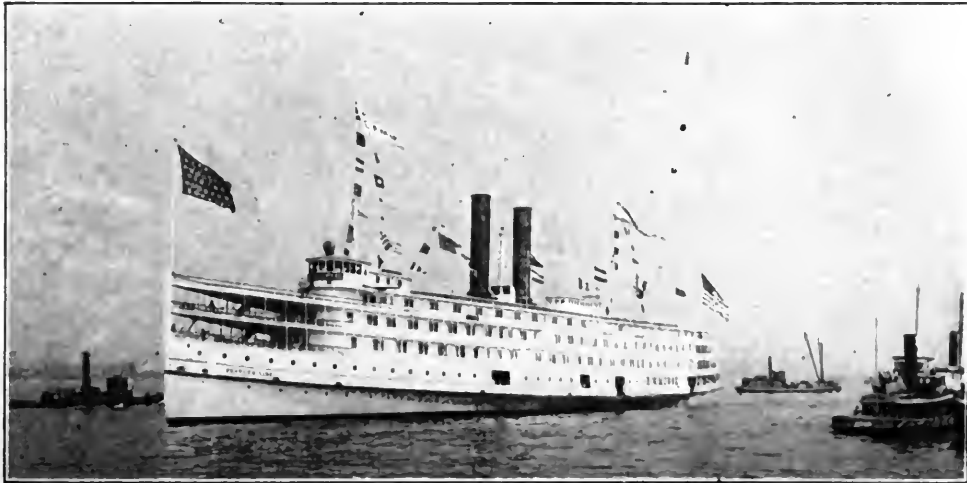

ONE HUNDRED YEARS OF STEAM NAVIGATION

The "C. W. Morse," which is now running on the night route from New York up the Hudson River, is a magnificent specimen of marine architecture at the beginning of this second century of steam navigation—Photographed for The Journal of American History

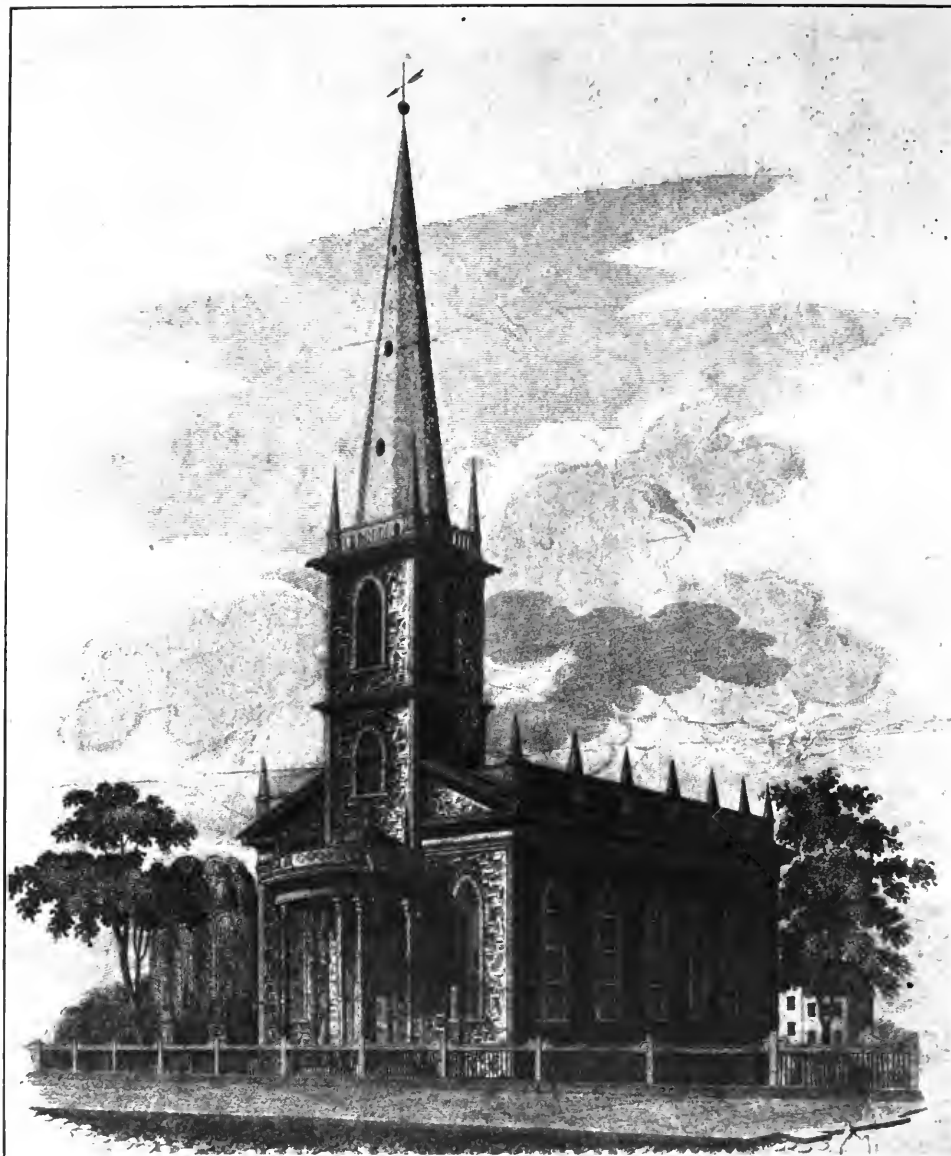

BURIAL PLACE OF ROBERT FULTON, PROMOTER OF STEAM NAVIGATION

Old Engraving of Trinity Church, New York, where Fulton's remains were placed in the Livingston vault shortly after his death in 1815—They will be removed to the magnificent mausoleum to be erected in his honor

1807—Centennial of Steam Navigation—1907

We have, then, but the "Clermont," "Car of Neptune," "Paragon," "Raritan," "Fire Fly," "Lady Richmond," "Washington," and a small steam ferry-boat and the "Demologos," besides the "New Orleans" and the "Vesuvius" on the Ohio river as having come direct from Robert Fulton. The "Emperor of Russia," which subsequently became the "Connecticut," was not built until a year after his death, which occurred February 24, 1815. It is possible that Fulton may have worked on the plans for this boat which was one hundred and thirty-four feet long, thirty feet wide and nine and a half feet deep. She carried three boilers and had an engine with a thirty-six inch cylinder and a five foot stroke. Her wheels were sixteen feet in diameter with buckets four feet ten inches wide that had a dip of two and a half feet.

The "North River," or "Clermont," ran until 1814, when she was superseded by the "Lady Richmond," but was not broken up till some time during 1825; the "Car of Neptune" was broken up after years of faithful service; the "Paragon," which had been used to tow the "Demologos" from the dock where she was built to Jersey City, struck on a rock while going up the river in 1820 and was so badly damaged that she had to be abandoned; the "Raritan" wore herself out on the river whose name she bore; the "Fire Fly" went onto Long Island Sound and was worn out in service around Providence; the "Lady Richmond" came into the possession of Captain Wiswall and ran for years advertised as "Slow but Sure;" the "Washington" was broken up on the Potomac and the "Demologos" was destroyed by an explosion on board at the Brooklyn navy yard, June 4, 1829, causing the death of twenty-five persons.

When the "Chancellor Livingston," of which we gave a picture in the last number of the JOURNAL OF AMERICAN HISTORY, copied from a rare lithograph of 1824, now owned by Mr. E.

E. Olcott, president of the Hudson River Day Line, came upon the Hudson it was expected that she would make marvelous time, but in this her builders were disappointed. On her trial trip, March 29, 1817, she ran to Newburgh in a "few minutes less than nine hours, of which time the tide was in her favor only three hours. In returning the same distance was run in eight hours and fifteen minutes—the greater part of the time against a flood-tide and a head-wind." It was calculated that she would go to Albany in twenty hours and she did actually succeed in making the trip, December 5, 1817, in eighteen hours. She ran upon the Hudson till 1824 when she was refitted for service on the Sound and later went to the coast of Maine.

While the "Chancellor Livingston" and the "Lady Richmond" were running as the only boats on the line of the North River Steamboat Company some question came up with the Post Office officials relative to the carrying of mail and a notice appeared in the papers stating that "The Post-Master-General, having declined sending mail by the North River Steamboats, excepting to West Point, Newburgh and Hudson, letters and papers will be received on board the boats for Albany and the different places to which the mails were formerly carried. Boxes are provided on board of each boat for the reception of letter, etc., etc."

This was practically the dawning of a new era. That matchless family of engineers at Hoboken had, for personal reasons, refused to enter into competition with the North River Steamboat Company, Chancellor Livingston and Colonel Stevens having been brought into relationship by marriage, but as soon as the old company had been dissolved, they brought onto the river one of their best boats from the Delaware river. It would not be possible to follow the story from this time on to the present in a single article and this must be reserved for

1607—Ter-Centenary of American Commerce

another time, but the progress that has been made from the time that the "Clermont" started out with a capacity of not more than a hundred passengers and a speed of not more than four, or possibly, five miles an hour, and the days of the "Commerce" and the "Fanny," or the even later, larger and faster "Champlain" may be judged by glancing at the new magnificent "Hendrick Hudson" of the Albany day line or the stately "C. W. Morse" of the People's Line of night boats to-day running between New York and Albany, shown here that it may be seen what progress marks the century of steam navigation.

To show the evolution of the Hudson river day boat a list giving the sizes of prominent steamers built for the business of carrying passengers between New York and Albany since the day of the "Clermont" is herewith appended:

Year Built.	Name of Vessel.	Length Feet.
1807	Clermont	133
1816	Chancellor Livingston	154
1832	Erie	180
1836	Rochester	209
1860	Daniel Drew	251
1864	Chauncey Vibbard	281
1881	Albany	325
1887	New York	350
1906	Hendrick Hudson	400

Early in the nineteenth century the Hudson river set the pace for speedy and magnificent steamboats. Following the advent of the crudely constructed "Clermont," the first vessel to be elaborately fitted was the "Chancellor Livingston," which appeared on the river in 1816, being the last steamboat designed by Fulton. Since that day the owners of each successive steamer have seemed to vie with one another to produce something greater and grander than the predecessors. Some of these early vessels would be called freaks nowadays. For instance, the "Erie" and "Champlain," built in 1832 for the day line between New York and Albany, were each propelled by two beam engines and carried four boilers and smoke pipes, two on each guard. Despite this apparent super-

fluity of power they were not as speedy as some of the contemporary steamers built some years before their advent.

To-day—at the close of the first century of steam navigation we find on the same "American Rhine" the most palatial river palaces that the world has ever known. Fulton, in his wildest dreams, never conceived such magnificent floating temples, one alone of which could carry away the entire population of any one of a greater proportion of the American communities. Along the deck of a modern steamer, plying the river where Fulton inaugurated steam navigation one hundred years ago, three "Clermonts" could be placed stem to stern, and five "Clermonts" easily carried side by side—fifteen "Clermonts" on its spacious deck.

There are yet so many things to be said of even the early boats and such an undeveloped field of history in the boats of more recent years that I shall not attempt to touch upon the story until some later opportunity when I hope to trace more in detail the several steps by which the original little craft, scarce larger than the railroad coach of to-day, has become the acme of all that is luxurious, safe and convenient as a mode of travel.

The story of ocean navigation, which I outlined in the preceding issue of this journal, is a later-day development from this same "Clermont" and is in itself a chapter of even greater marvels.

At this time when the world is paying homage to Robert Fulton, and through him to the several men who laid the foundation upon which he builded, I cannot refrain from tossing back at the populace the jibe which it threw at steam navigation an hundred years ago:

Jonathan Hulls
 With his patent skulls
 Invented a machine
 To go against wind with steam
 But he being an ass
 Couldn't bring it to pass
 And so was afraid to be seen.





American Progress in the Middle West

Voice of the People as Expressed through Messages
from the Governors of the American Commonwealths

TO
THE JOURNAL OF AMERICAN HISTORY

BY



Albert B. Cummins

GOVERNOR OF IOWA

IT is believed that Father Jacques Marquette, the French missionary, and Louis Joliet, the French explorer, in their famous expedition into the far West, first entered the Mississippi river at a point nearly opposite the town of McGregor, on the seventeenth day of June, 1673, and it was then that the eyes of white men first fell upon the shores of the territory now called Iowa. They floated down the Mississippi nearly the whole width of the state, making frequent landings upon the western bank. They did not, however, find any permanent settlements. Between 1673 and 1784, many white hunters, trappers and explorers made journeys along the Mississippi river, occasionally penetrating a short distance into the interior, but the first settlement within the state of Iowa was made, in 1784, by a Frenchman named Julien Dubuque. There was little growth, however, for many years, and it was not until in 1832 that the rapid and continuous inflow of white settlers began. When civil government was first extended

over Iowa, it was as a part of Michigan Territory. It shortly after became a part of the Territory of Wisconsin, and in 1838 the Territory of Iowa was established.

The Territory of Iowa became a state on the twenty-eighth day of December, 1846.

According to a careful census taken in 1905, the population was 2,210,050. It is believed that the present population is substantially that shown by the census of 1905. The chief occupation of the people and dominant interest of the state is agriculture.

At the present time, Iowa is not getting many immigrants, comparatively speaking. In the earlier years of the state, when land was cheap, Iowa received a great body of immigrants, mainly Germans, Swedes, and Norwegians. Almost invariably, they became farmers. It is, of course, true that we received many of other nationalities,—Irish, Bohemians, with a sprinkling of Englishmen, Irishmen, Frenchmen and Swiss. They are diffused, generally, through the various occupations. Within the last few years, we have received some Italians

Message from Iowa by Governor Cummins

and Russians, who live mainly in cities and towns.

Taking the immigration into Iowa as a whole, its effect has been highly beneficial, and the standard of our citizenship has not been lowered by these recruits of industry.

Corporal punishment is not forbidden by law, but rarely, if ever, inflicted.

Necessarily, Iowa is making the most progress in the development of her agricultural interests. The wonderful growth in the science of agriculture in the last few years has revolutionized Iowa, and inasmuch as there is no other state in the Union that can compare with her in the proportion of good land to the whole area, she has no equal in the productions of agriculture. It follows that Iowa is prosperous, and it may be fairly said that she has always been prosperous.

It is difficult to call the complete roll of those who have been prominent in the several pursuits of life, and it would be invidious to present a partial one; therefore I shall not attempt a reply to this question, further than to say that the history of the country

will bear witness to the part that Iowa has borne in the drama of national life.

Iowa's need is the nation's need. Nature has given us the richest dowry ever bestowed upon organized humanity. Our greatest need in the past has been, at the present is, and in the future will be, strong, good men and women. We have been especially fortunate in the number of such men and women, and all that we need to do in order to accomplish the destiny of the Republic and the state is to maintain the standard.

It is enough to say that patriotism is not waning. When we remember the unselfish devotion of our people in all the days of peril, it is difficult to say that our patriotism can increase.

What does the future of the Nation portend? If by this question you mean to ask what the future of the Nation will be, my answer must be a mere prediction. I believe that the United States will be the exemplar of the whole world, and that in government, in morals, in wealth, in the lives of our men and women, in the volume of business done, and in the extent of the things we create, it will lead the march of nations.

"WE WANT PATRIOTS IN EVERY DAY LIFE"

EXCERPT FROM

HONORABLE CHARLES E. HUGHES, GOVERNOR OF NEW YORK

We are too often content with a vague notion of duty to country. Some who would give their lives for their country in time of war are satisfied in time of peace with any conduct promoting their own benefit which comes close enough to the line of rectitude to keep them out of jail. They may have patriotism which is useful in a great national emergency, but at other times they constitute a menace to the country which they profess to love. The man who regards with sullen indifference the congested life in our great city, who is content to pleasantly wrap himself in the garments of prosperity and think of his fellow creatures as ignorant and disorderly masses with whom he has nothing in common, has small right to

pride himself upon the valor of his Revolutionary ancestors or talk of his patriotic devotion to his country. He who in ostentatious parade, in idle indifference to all that makes for better living, in disregard of opportunity to serve his fellow men, turns a deaf ear to the voice of entreaty which comes from his struggling brother, does not know for what our fathers died and has yet to learn why this Union should be preserved. The man who by the inflation of values seeks to compel an exaggerated return for public service, does not appreciate the meaning of the battle of Lexington. We want patriots in finance; we want patriots in the organization of our corporations; we want patriots in the management of our public utilities.

American Progress in the Great Southwest



BY

HONORABLE THOMAS M. CAMPBELL, GOVERNOR OF TEXAS

THE first settlement of Europeans within the bounds of the territory now called Texas was made by Robert Cavalier Sieur de La Salle at a point named by him Fort Saint Louis, on the Lavaca river near Matagorda bay, in the year 1685. This, the cradle of European civilization, was also the grave of the first settlement. Yet its brief existence was sufficient to alarm the jealous Spaniard, who also claimed Texas, and to cause him to attempt the settlement of this region. In 1689 and 1690, expeditions penetrated from Northern Mexico far into the interior of Texas, and the second expedition left behind it a small establishment, near the Trinity river, in Eastern Texas, called Misión de los Tejas. This settlement was almost as short-lived as that at Fort Saint Louis; its results were the origin of the name Texas and renewed attempts on the part of the *padres* to occupy Texas permanently to do missionary work among the docile tribes. About 1715 they returned, and thenceforth the presence of Spanish settlers in Texas has been continuous. For another century, however, this beautiful country with its unsurpassed fertility of soil and unbounded natural resources remained practically undisturbed; the thralldom of the Spanish régime was a blight to the minds and spirits of all. With the advent of the nineteenth century, Texas for the first time came into the foreground, and the rôle she was destined to play dur-

ing the next thirty years is phenomenal. "But her elevation was not due to internal development. It was the effect of external influences and the advent of another race of men; the Anglo-American element gained for her a name in the history of the New World."

After winning her independence from Mexico and successfully maintaining the same for ten years, Texas was admitted to the American Union on December 29, 1845. In the terms of annexation, Texas reserved the ownership of her public lands. Her public domain has since enabled her to pay off her public debt, to endow her educational and eleemosynary institutions, to attract immigration, and to promote the building of many miles of railroads. The total population in 1847 was 142,000; her present population is twenty-five times that number, or about 3,600,000; yet there are less than eleven persons to the square mile. Of this total population "all but 650,000 live on farms and in small villages. Eighty per cent of the values produced in Texas annually come direct from the farms, while ninety per cent relate to this source directly or indirectly."

Texas is receiving a large number of new settlers. The great majority of them are from the wheat-growing states of the Union. Some immigration from Europe (German, Bohemian, etc.), and from Mexico also flows in this direction. The greater portion of this addition to our population finds lodgment directly upon the

Message from Texas by Governor Campbell

farm. The effects of immigration upon the citizenship of the state is imperceptible.

While not forbidden by law, corporal punishment is rarely resorted to in our public schools. The same can be said of capital punishment as dealt out by our courts of justice. The state has not abolished capital punishment, and it is invoked in extreme cases. The governor has the constitutional power to commute death sentences.

Texas is enjoying a season of prosperity never before equaled in our history. It would be too tedious to attempt an exhaustive enumeration of the various lines of progress. Suffice it to say that the farmer is enjoying a goodly portion of present prosperity. Naturally, all associated with him are reaping a portion of the benefits. Banks are growing in number, capital, and deposits; railroads are extending their lines and adding to their rolling stock; manufactories of various kinds are springing up and farms are being pushed into areas that have never before felt the civilizing influences of the plow.

Progress in the field of literature, arts and science is more difficult to define. Here activity is not subject to geographical areas or limited by natural boundaries. Therefore, it is not surprising to find the sons of Texas members of the faculties of the principal universities of the land. Works of Texan artists adorn the principal galleries of art in Europe and Amer-

ica. Texan scientists and engineers are found the world over. In business Texans are found among the leading factors in the trade centers of our country. As politicians and men her sons command respect in counsels where wisdom has weight and the public welfare is the rule of conduct. As soldiers, the descendants of the brave defenders of the Alamo have not suffered their reputation for gallant courage to be tarnished either in the Mexican War, Civil War, or the late war with Spain.

The greatest need of Texas to-day, as well as of the nation, to conserve the blessings enjoyed, is the presence of an honest and enlightened citizenship—a citizenship that feels its responsibilities and maintains a public sentiment that will make the performance of duty and the enforcement of law speedy and natural.

There is much in the past history of Texas that is powerful for good in accomplishing this end. Every child that attends the public schools of Texas is directly indebted to and benefited by the unselfish and far-sighted statesmanship of the founders of the Republic. Patriotism is not, and will not decrease so long as the stirring deeds of our forefathers are recounted. The teaching of Texas history in the public schools is required by law.

The future portends a broader love of humanity, a deeper public philanthropy, and the most wonderful progress in the essentials of an ideal civilization the world has ever witnessed.

THE MILLENIUM OF AMERICAN CITIZENSHIP

BY

HONORABLE CURTIS GUILD, JR., GOVERNOR OF MASSACHUSETTS

The ideal citizenship, the ideal commonwealth, cannot be built by educational laws alone. The millennium of American citizenship will only come when an aroused public conscience had educated the educated.

There must be something more than the education as taught in the schools.

The press, the pulpit, and above all, the home, must furnish supplementary education, not of the hand nor of the brain, but of the soul and of the conscience, without which educated brain and hand may be even more dangerous to society than unintelligent ignorance.

Boundless Riches of the American Interior



BY

HONORABLE GEORGE L. SHELDON, GOVERNOR OF NEBRASKA

THE first permanent settlement in Nebraska was at Bellevue, on the Missouri river, eight miles below Omaha, about the year 1810. It was a fur trading post in charge of a Frenchman from St. Louis and was for many years the rendezvous of white explorers; Catlin, Prince Maximilian and John C. Fremont found hospitable shelter there.

The presence of white men upon Nebraska's plains dates back forty-six years before the first English settlement at Jamestown. Francis Vazquez Coronado, a Spanish knight, with seventy horsemen, in the summer of 1541 made the long march across the plains from the valley of the Rio Grande to the kingdom of Quivira in Kansas and Nebraska, reaching the fortieth degree of latitude according to their observations and record. This Spanish army found a soil "very fat and black, with abundance of plums and nuts and very good, sweet grapes and mulberries," but three hundred years more were required before the people were ready to accept the truth of this early Spanish story and make homes upon the rich prairies of Nebraska.

The earliest record of French exploration of Nebraska is about 1705, when a trapper named Laurain came down the Missouri with two canoes loaded with furs. The first men to thoroughly explore Nebraska were the Mallet brothers, Frenchmen, who, in 1739-40, wintered with the Pawnee Indians and journeyed the entire length of the Platte Valley.

In 1803, Nebraska became a part of the United States and in 1804 the first council between the United States and the Indian tribes of the Louisiana Purchase was held by Lewis and Clark at what is now the village of Fort Calhoun, eighteen miles north of Omaha. The site of the council is now marked with a large glacial boulder with the dates "1804-1904" cut thereon. The steam navigation of Nebraska waters dates from the year 1819 when the steamboat "Western Engineer" arrived near the present city of Omaha with the scientific expedition of Major Long. The first wagon trail across the state was made in 1832-34 by Captain Bonneville and Wyeth. This afterward became the "Oregon Trail," over which hundreds of thousands of people and wagons passed in the thirty years following. It may yet be traced in some places to-day.

The first mention of the name "Nebraska," as applied to this region is in the report of Secretary of War Wilkins, November 30, 1844. The first bill to organize the territory of Nebraska was introduced by Stephen A. Douglas of Illinois in the House of Representatives, December 17, 1844. Nebraska became a territory May 30, 1854, and a state March 1, 1867.

The present population of the state is about 1,250,000, the majority of whom gain a living directly from the "fat, black soil" seen by the Spaniards almost four hundred years ago, either by farming, fruit growing or cattle raising.

A large part of the recent immigration to this state has been from farmers in states east of us who have

Message from Nebraska by Governor Sheldon

sold their lands at a high price and bought better land in Nebraska. There is still room for more of these under intensive farming now being introduced. There are large colonies of Germans, Swedes, Bohemians, Hollanders, Russians, Poles and Irish located in various Nebraska counties. Most of them are engaged in farming, are very prosperous and are among our most desirable citizens. The children of these immigrants from the old world seek eagerly the best education the state can give, take active part in all the social movements and are thoroughly American in spirit.

Nebraska has the lowest percentage of illiteracy of any state in the Union and corporal punishment has become practically unknown in our schools. The children of Nebraska learn willingly and without force. The law of Nebraska still permits capital punishment for murder, although every recent session of the legislature has witnessed a vigorous effort to repeal the law. At present, capital punishment can take place only in the state penitentiary and in the presence of a limited number of people. Two persons have been thus executed.

The greatest material progress now being made in this state is in the direction of scientific farming and agricul-

tural education. Farm life is being made attractive by telephone lines and rural free delivery which brings the farmer into contact daily and hourly with the rest of the world. The greatest political progress is being made in the direction of public control of corporations and democratization of government through the direct primary. The past ten years have been years of great prosperity to the farmer and all other classes have shared in his abundance.

Nebraska's greatest need is the firm and popular establishment of a merit system of unselfishness, inventive devotion to duty in all branches of the public service, both state and local. The greatest need of America is Nebraska's greatest need multiplied by forty-eight.

Patriotism is growing. It is no longer expressed by the ambition to kill other human beings. It means the courage to face opposition in behalf of honest government, better ideals of citizenship, better distribution of social blessings and a wider and warmer fraternity between men. The future of America is the promise of a spread of democracy throughout all the nations of the world and for union in a world's federation of peace and progress.

THE RISE OF THE BOUNTEOUS SOUTH

EXCERPT FROM

HONORABLE CLAUDE A. SWANSON, GOVERNOR OF VIRGINIA

In three centuries the one hundred and five colonists who settled at Jamestown in 1607 have grown into almost as many millions. From petty and despised dependants, vainly petitioning parliament and kings we have become a great power, most potential in the affairs of the world, courted and respected by all. We have become strong enough to announce and maintain the great Monroe doctrine, which extends our protection to the Western Hemisphere and defends it from foreign aggression and con-

quest. When this colony was planted here Spain ruled with an iron hand more than half the world. But a few years ago this nation, which grew from this small beginning, drove Spain from the Western world and destroyed her colonial empire. The history of this nation from Jamestown to the walls of Pekin in China indicate an heroic achievement, a growth in greatness and power, unexcelled. From suffering and poverty we have grown to comfort and wealth. Our wealth to-day is greater than that of any other nation.

The American Spirit in the Mississippi Valley



BY

HONORABLE JOSEPH W. FOLK, GOVERNOR OF MISSOURI

THE oldest settlement in Missouri is the town of Ste. Genevieve, which was founded in 1735. At an earlier date (1719) the French established Fort Orleans, on the Missouri river above the mouth of the Osage, but this place was afterwards destroyed by the Indians. Daniel Boone was the first American to come to Missouri, he having emigrated to this state from Kentucky in 1795. There were no American settlements in the territory prior to the Revolutionary War, and the American migration did not begin until after that war; but the French and Spanish, before the American advent, had established missions at New Madrid, Ste. Genevieve and St. Louis. Missouri was admitted into the Union August 10, 1821.

The present population of Missouri is conservatively estimated at four millions.

The chief occupations of the people are manufacturing, mining and agriculture.

Foreign immigration into Missouri is estimated at about fourteen thousand per year. They are chiefly Germans, Irish, Greeks, Italians, Austrians and Swiss, in the order named. The Greeks and Italians usually become day laborers; the Irish and Germans enter the trades and professions; the Austrians are about equally divided between the trades and day labor, and the Swiss engage chiefly in dairying and cheese-making. They exert no appreciable effect upon the general character of our citizenship.

Corporal punishment is practiced in our schools, but the practice is not so general as it formerly was, and is steadily diminishing.

Capital punishment is practiced in Missouri, but the last regular session of the legislature passed a law giving to the trial juries in murder cases the option as to whether the death penalty or life imprisonment shall be imposed in cases of murder in the first degree.

Missouri is progressing rapidly, and in about the same proportion, in poultry and stock raising, manufacturing and mining, the mining interests alone being now valued at about thirty-five millions. The state is more prosperous than ever before in its history.

Missouri claims Mark Twain, Eugene Field and Winston Churchill as part of her contribution to the literature of the nation. In journalism she has produced George Horace Lorimer, editor *Saturday Evening Post*; Joseph Pulitzer of the *New York World and St. Louis Post-Dispatch*; the late Joseph B. McCullough, formerly editor of the *St. Louis Globe-Democrat*, who invented the newspaper interview, and also one of the owners of *Puck*.

To art Missouri has given George C. Bingham and his famous painting, "Order Number Eleven."

To science Missouri has contributed Dr. T. J. J. See, discoverer of the binary stars, and one of the world's greatest astronomers; Dr. Jackson, who established the first railway hospital system in the world; Dr. Beverly Gallaway, who discovered the process

Message from Missouri by Governor Folk

of immunizing Northern cattle from "Texas Fever;" Eads, the builder of the famous Eads bridge at St. Louis, and Henry Johnson, builder of the Galveston sea-wall.

Missouri has given to the Union many prominent business men, among them Benjamin F. Winchell, the present head of the Rock Island railway system; Henry Miller, general manager of the Wabash railway system; A. D. Brown, one of the leading shoe manufacturers of the world; N. O. Nelson, one of the nation's most prominent iron manufacturers, and Adolphus Busch, who has built up in St. Louis the largest establishment of its kind in the world.

Many of the country's greatest statesmen have been Missourians, among them Senator Thomas H. Benton, "Old Bullion;" B. Granz Brown, a former governor of the state, who was prominent in national politics; Senator Frank P. Blair, Senator George G. West, Carl Schurtz, who was a United States senator from the state; Richard P. Bland, father of the "free silver" issue in American poli-

tics; President Ulysses S. Grant; former Senator Cockrell, who is now a member of the Interstate Commerce Commission; William T. Harris, formerly United States Commissioner of Education. Missouri has also given to the Union four cabinet ministers: Edward Bates, who was one of Lincoln's attorney-generals; D. R. Francis, John W. Noble and E. A. Hitchcock, all of whom served in the office of Secretary of the Interior. Among Missourians known to fame for their military genius may be mentioned General Sterling Price, General Joseph Shelby, General A. W. Doniphan and General Stephen W. Kearney.

Missouri's greatest material needs to-day are better country roads, improvement of the Mississippi and Missouri rivers and more railroads. Fruit-growers and dairymen are needed for the Ozark region.

America's greatest need to-day is the removal of all unnecessary restrictions upon trade and the attendant expansion of industrial opportunity and a strict enforcement of the laws.

There are now signs of a revival of patriotism throughout the country.

TRADE OF A MULATTO BOY IN 1765

Accurate Transcript of Original Document in Possession of
MARY R. WOODRUFF, Orange, Connecticut

Know all men by these presents that I Zachariah Thomlinson, of Stratford in the County of fairfield and Colony of Connecticut in new england, for the Consideration of eight barrils of good merchantable pork allready in hand Recd of Joseph Woodruff of Milford which is to my full satisfaction and contentment, Do relinquish, release and pass over unto him the Sd Joseph Woodruff and to his heirs and assigns forever, all my right, title and Interest in, and unto the Servitude of one Certain malatto boy named Job, aged nine years, born of an Indian woman named Nab, to have and to hold Sd Malatto boy free and clear from all Claims and Demands made by me or my heirs and further I the Sd Zachah Thomlinson Do for my Self and my heirs Covenant with him the Sd Jos. Woodruff and his heirs that he and they Shall Quietly and peaceably possess and enjoy Said Malatto boy Job without the Least Interruption or molestation from by or under me or my heirs forever. In witness whereof I have hereunto Set my hand and Seal, this 21st Day of May Anno Dom. 1765. Signed, sealed and Delivered
In presence of

ABNER JUDSON
WILLIAM PIXLEE

(Signed) ZACH: TOMLINSON.

An American's Experience in the British Army



**Manuscript of Colonel Stephen Jarvis, Born in 1756,
Revealing the Life of the Loyalists who Refused
to Renounce their Allegiance to the King and Fought
to Save the Western Continent to the British Empire**

**ORIGINAL MANUSCRIPT NOW IN POSSESSION OF
HONORABLE CHARLES MAPLES JARVIS**

DESCENDANT OF COLONEL JARVIS AND MEMBER OF MANY AMERICAN LEARNED AND PATRIOTIC SOCIETIES

THIS remarkable manuscript, recently rescued from oblivion, is undoubtedly the most important documentary evidence of its kind in existence. In it is revealed the tragedy of an American who for the sake of family and principle took up arms against his fellow Americans and met them in deadly conflict on the firing line. It is the story of a man who withstood the rebuffs, taunts, and insults of his closest friends, who suffered terrible privations, jeopardized his life, and was finally driven from his home to seek refuge on British soil. Withal it is one of the most intense stories of patriotism, of fidelity to family and loyalty to the Mother Country.

When the Americans, through their misunderstandings and differences with Great Britain, proposed the stroke for Independence there were many conservative and influential men who considered the action too radical. They looked upon England as their homeland; their blood was British and there was a filial love for the British Empire. While they were willing to join in urgent appeal to the crown and to respectfully demand redress for existing griev-

ances, they were unwilling to become a party to the proposed Declaration of Independence and stoutly refused to join any revolutionary movement. These loyalists came from every rank in society, and "being actuated by conscientious motives, command our thorough respect."

When the Revolutionists began to arm themselves for the Great Struggle many of these conservatives offered their services to the King, remained loyal through the conflict, and "suffered severely in exile when the contest was ended."

This ancient manuscript, now almost illegible, is written by one of them. It uncovers many secrets. It reveals the contentions, despairs and almost insufferable hardships of the defenders of the crown. It passes the scouting line, penetrates the ranks of the red-coats and takes one into the heart of the British Army. It is a revelation of the life of the men who fought and died for the King in trying to save the Western Continent to the British Empire.

The writer of this remarkable manuscript is one Stephen Jarvis. He was born November 6, 1756, in Danbury, Connecticut, and died in Toronto, Canada, in 1840, at the age of eighty-four years.

Manuscript of Colonel Jarvis—Born in 1756

Relating the remarkable experiences as a recruit in the lines of the British army—Accurate transcript from the original manuscript which was lost for many years and has been recently recovered

MY father was one of those persons called Torries. He lived in the Colony of Connecticut, his disposition was more for making a comfortable living for his family than giving his children a liberal education. My advantages were thereby confined to what was necessary for a farmer, which I followed until I was at the Age of Eighteen years, when hostilities commenced between Great Britain and her Colonies.

It cannot be expected that I should give a minute detail of every circumstance of my eventful life, as I kept no regular journal, and have to refresh my memory from public documents for the last fifty years.

Son of a Loyalist in Ranks of the American Revolutionists

Some time in the month of April, 1775, when the first blood was shed at Lexington, I became acquainted with a Lady to whom I paid my address, and who I afterwards married; this attachment was disapproved of by my father, who carried his displeasure to great lengths, and I was under the necessity of visiting the Lady only by stealth. Soon after the Battle of Bunker Hill, and about the time that the British Army Evacuated Boston, there was a draft of the Militia of Connecticut to garrison New York, and I was drafted as one; my father would readily have got a substitute for me, but as he had so strenuously opposed my suit, I was obstinate and declared my intentions of going as a soldier,—for this declaration he took me by the arm and thrust me out of the door; during the evening, however, I went to my room and went to bed. The next day was Sunday and I kept out of sight, the next morning

we were to march, a Brother of my Mother was the officer commanding. On leaving the house I passed my father and wished him "good-bye," he made me no reply, and I passed on to the house of my uncle, the place of rendezvous, but before the Troops marched my father so far relented as to come to me and after giving me a severe reproof, ordered me a horse to ride, gave me some money, and I set off. We arrived in New York the next day, and my uncle took up his quarters at Peck Slip, and took me into his house. He had a son with him, a little younger than myself, with whom I spent my time very agreeable.

Repents when He Sees Father's Displeasure and Joins British

During my short stay in New York, which was only about a fortnight,—during that time, however, the Americans broke ground on Governor's Island. My uncle was one of the officers for that duty. The British Man of War (the Asia) was lying off Staten Island at the time, and I had an inclination to get on board of her; I, therefore, went to the Island with my uncle and remained there all night, and part of the next day, when we were relieved by another party, and returned to the City. Having had no rest during the night, I lay down and *went to sleep*. I was awoke by my Cousin; the streets were filled with soldiers, part of the American Army from Boston. The next morning the Militia was dismissed, and I returned to my family; I represented to my father that I was very sinable, that I had done wrong in espousing a Cause so repugnant to his feelings, and contrary to my own opinion also. Asked his forgiveness, and went even so far as to promise that I would give up my suit with Miss Glover, for that

An American's Experience in the British Army

was the Lady's name. On this promise, I was again taken into favor—but I only kept this promise but for a few days,—as soon as I had replenished my wardrobe, I immediately set off to visit Miss Glover, and before we parted, we renewed our vows of love and constancy. My reception the next morning was everything but pleasant. I continued, however, to visit her as often as I could. After the British Army had taken New York, the Militia was again called out, and I was again drafted, but I refused to serve; about this time three Tories who had been confined in Symsbury Mines, had made their escape, and was, by the assistance of the Loyalists, enabled to join the British Army;—many of the Loyalists also joined them and went with them, and among the rest myself, and this with the consent of my father, as I had been instrumental in making provision for the three men who had escaped from Prison.

Recruiting American Soldiers for Service in England's Army

I left Danbury in the middle of the day, armed *Cap-a-pie* under pretense of joining the Americans then lying at Horse Neck,—and went forward to make provision for those who were to follow me at night. I passed on as far as Norwalk, where I was directed to call on certain persons, Loyalists, for advice and assistance in executing our plan. The first one I called upon informed me "that our plans were discovered, that the whole coast was guarded, and that if we proceeded we would all be taken prisoners, and advised me by all means to return home again with the best excuse I could make for doing so." I took his advice, and after refreshing myself and horse, I retraced my steps to Wilton, and called on a Mr. B——s, his house was the place of rendezvous for the whole party;—I had a wish to see what reception I would meet with as an American soldier. I, therefore, feigned myself much hurt from the

fall of my horse, told him a long cock and bull story of my going to join the American Army, and said everything to excite his compassion, and to be allowed to sleep by his fire during the night; this he refused, but offered to assist me to the Public House, where I could be comfortably provided for;—finding nothing would prevail, I then asked him if his name was not B——s. He with some surprise, answered "Yes and what then," his wife and two fine daughters who were sitting in the room viewed each other with much uneasiness. I desired to speak to Mr. B. in private. We walked into another room; I asked him if he knew Mr. J—— of Danbury, and he replied, "that he did."

I told him I was his son, communicated to him the commission I was entrusted with, gave him the information I had received at Norwalk—and the necessity there was for finding a place of safety for the three men. One of them was a Mr. Mc-Neal. The other persons names I have forgot. Mr. B. then took me by the hand, introduced me to his wife and daughters, ordered refreshments to be got ready as soon as possible, for that I was very tired and hungry. My lameness was set aside for the night and he set about preparing a hiding place for the three men and getting sustenance for their support. I then suggested the necessity of as many of us as possibly could, should reach home before daylight, gave him the countersign, whereby he could make himself known if he met any of our party, and turn them back; sent a message to my father in what manner I should return the next day. He set off and after proceeding a few miles, stopt in a wood by the side of the road. He soon saw two men approaching, gave the countersign, which was answered. They were two young men from Danbury, he delivered my message to them; they returned home, and he returned to his house. Before his return, however,

Manuscript of Colonel Jarvis—Born in 1756

the party had arrived to the amount of seventy persons. A man by the name of Barnum, who had been with the British, and returned for recruits conducted the party, he was no way discouraged from my information and urged me to proceed with them, this, however, I declined, he however prevailed on Mr. B. to try and overtake the two men he had turned homeward, but after he had pursued them near to Danbury, he was obliged to return without them, and he hardly reached his home before daylight. I met him afterwards a Major in the British Army. Mr. Barnum and his party pursued their route and got safe to the British.

Americans Fleeing from being Drafted by Revolutionists

The next morning, after breakfast, I took leave of this kind family, bound up my knee in a piece of old blanket, assumed my lameness, was helped on my horse, and set off for home. Many questions were asked me on my route, and many foolish answers were given as to my late disaster. Suffice it to say that when I reached home I found my father had received my message, and had a surgeon, whom he could trust to attend me. I was helped off my horse, carried into the house, my knee which he declared to be dislocated, again placed into the socket, the bandages filled with the spirits of turpentine, and in this manner I walked with crutches for ten days; this lulled all suspicion; even my mother was deceived, for she had no idea that my intentions were that of going to the British.

For the rest part of the summer I remained quietly, until the Autumn, when I again joined another party of Loyalists, and proceed to the waterside, but the vessel which we expected to take us on board not arriving, and my father hearing of the situation in which I was placed, sent a person for me and I returned home the second time. On my arrival I

found my father's house filled with American soldiers, my father introduced me to the officers as returning from a visit to see my friends, and all went on very well, until the first day of January, 1777—it being New Year's day—I rose very early in the morning, and in opening the door I discovered a large body of horsemen armed, with a number of prisoners, and some of them, those I had a short time before left at the Seaside. I must leave the reader to judge of my feelings for I cannot describe them.

I remained quiet during the day, but I was lead to believe that I should not continue so during the night, and therefore kept a sharp lookout; I came very nigh falling into their hands. The day had been stormy, both snow and rain, and the roads very sloppy. I had prepared a horse with intentions to ride out of town. I had set down to supper, when one of the Committee of Safety (as they were called) came in; my father urged him to take supper, this he declined, and after making some excuse for calling, he left the house. I immediately got up from the table, went to the door, the night was very dark. My brother had gone out to do an errand for one of the prisoners and as I stepped on the threshold of the door I heard him call to one of the prisoners. "Stop" said a person close by me.

Tory Boy Escapes on Horseback as Patriots Search Father's Home

I gave a spring and in a moment I was on horseback in full speed down the street. I made a halt at a friend's house for a few moments, when my sister with another young lady came in, saying "Brother, the soldiers are searching the house for you." I immediately set off again and took shelter in a house where there was two British prisoners of War. One part of the house was occupied by soldiers from the Eastward going to join the Army of the

An American's Experience in the British Army

Americans, then lying near White Plains. I remained in the quarters of the British prisoners until the soldiers were asleep. I was then conveyed to a small room in the garret with some provisions for the twenty-four hours. Here I remained until the next evening, when I met my father in the field back of the town. He had a shift of clothes for me and some money—here we parted, and I set off for the house of a Brother-in-law of Miss Glover who was a Loyalist, and where I knew I should find safe quarters. The late rain had flooded the banks of the Rivers, and had overflowed the road in two places, so that I was obliged to wade to my hips in water. The weather very cold, my clothes became very stiff with ice. I could with difficulty travel; I however made out to reach a friend's house, about five miles from my father's; Here again I was encountered with another band of soldiers (strangers). I pretended as coming from the next house, and crossing a small stream on a log had tumbled into the water, and begged my friend to give me a shift of clothes.

I was taken into a small room, where there was a good fire, dried my clothes, got some refreshment, and after the soldiers had got asleep, a young man of the house conveyed me to the stable, took a horse and carried me five miles farther, to the house of Mr. Hawleys whose wife was Miss Glover's sister;—the young man remained with me until after breakfast the next morning, and then returned to his father. He was the same day taken up and carried to Gaol, for what crime I never learn't,—the day after my arrival, Mr. H. sent and fetched Miss Glover to his house and the pleasure I spent in her society surely can be better imagined than described. At the end of a fortnight a Mr. T——s., who had married another sister of Miss Glover's, came to take her to his house (he was

a Republican and I dare not see him). He arrived in the evening, it was a moonshine night, and Miss G. pretended that it would be some time in the evening before she would be ready to set out, left him and visited me in my apartment. In this manner we kept him until a late hour, when we at last took leave of each other, and she set off with her brother Mr. T.

Driven into Hiding for Refusing to Denounce the King

The next night I set off from Mr. H——'s (I dare not travel in the day) and went to Norwalk where my father had two brothers, and where his father was also living—with them I remained for sometime, but hearing that there was an opportunity that probably I might have in getting over to Long Island from Stamford, I repaired thither, where my father had another brother whose four sons were already with the British, two of which had entered the Army. Here again I was disappointed—no opportunity offered of getting away. It was agreed at last, as the best mode of safety, and as the smallpox was in the place, I had better get Enoculated and that his young son should also. He sent for the surgeon of the Hospital, a Doctor W. and we were Enoculated. We remained at my Uncle's until a few days before we broke out, and then was removed to the Hospital.

We both had the disease favorable, and about the first of March I ventured to pay a visit to my father's, taking the night for performing the journey. I arrived at his house about midnight, called at the windows of his bedroom, he awoke, knew my voice, and let me in. I remained with the family only two days and then for the last time I bid them good-bye for seven years, and returned again to Norwalk, from thence to Stamford, to Greenwich, and so back and fourth until the British Army made an excursion to Danbury. The day the fleet sailed up the sound I was at the

Manuscript of Colonel Jarvis—Born in 1756

village of Greenwich, and remained there until the British Army had marched to Danbury, and had again re-imbarked for New York. In this expedition Munson Jarvis and William Jarvis were with the British and slept at my father's house the night they were in Danbury. On the 28 of April, 1777, at night I prevailed on a person to set me across to Long Island, there was a skiff and a canoe loaded with potatoes and two or three calves.

Crossing Long Island Sound in Canoe to Join the Redcoats

We set off about 10 o'clock at night, and got out of the river undiscovered and steered our course for Long Island. In the morning we found ourselves under the Long Island shore, the wind was strong from the Eastward—our log canoe was swamped in running ashore, but no lives lost; after hard rowing, we at last reached the Harbour of Huntington, went on board the Guard Ship in the Harbour, where I was obliged to remain until report was made to the Commanding Officer at that place; I then was permitted to land, here I met with several persons I know, and I was strongly urged to join the Army. This I declined and the next day set off for New York in company with a Mr. Booth, a native of Newtown in Connecticut. On my arrival in New York I found many persons from Danbury, who were made prisoners. They informed me that after the British Army had left Danbury, the Americans had killed my father. (This was not true, they only plundered him).

This melancholy news determined me for a Military life. I therefore took the first opportunity of introducing myself to an officer, that first fell in my way. It was with a Captain Lockwood, who piloted the British Army to Danbury. I told him what I had just heard relative to the fate of my father, and my deter-

mination of entering the Service;—He replied "That he was raising a Company for a Corpse that was to be commanded by a Major Starks, and that if I would join his Company, he would procure me a commission, and as his company was about to march to Kingsbridge, where the Regiment to be organized, and if I would consent to act as Sergeant in his company until he could join the Regiment—with my commission he would be very glad, and in the meantime he would be glad that I would assist him in making out a statement of his Company." This I assented to, and being ignorant of the consequences that would result, suffered myself to be set down as Sergeant, for the present until my commission could be procured.

American Lad under English Ensign Marching against His Countrymen

The next day the Company marched to Kingsbridge under the command of a Lieutenant Clôse, where we joined the rest of the Regiment, but so small were our numbers, that I have no recollection who was the commanding officer;—the day after our arrival at our Incampment there was an order for each Company to give in a Morning Report; of what a Morning Report was, neither Mr. Clôse or myself knew anything about more than we did of the Longitude, and I was sensible that I was the best scholar of the two, and being second in command, thought I was of equal rank with him, and without consulting him on the subject, I walked over to the tent of my relation, whose Regiment had taken up their ground on the left of our small (for it was a very small) Regiment to attain the information necessary to comply with the order.

My friend gave me a number of printed copies that had been given him for his guide,—to wit—fit for duty—sick—on duty, etc., etc. I return to my tent, and return the whole fit for duty, although we had neither

An American's Experience in the British Army

arms, clothing or ammunition; the result of which was that there was on order for our Regiment to parade so many men for piquet. This put me to my wits end, to parade men without arms was ridiculous, but there was no time to be lost; I therefore went from one tent to another (for some of the Companies had received arms) got a stand of arms from one Company, a sick man's arms from another, until I had completed the whole with arms and marched them off for to this parade. Behold me then, for the first time in my life, a soldier in the British Army, commanding an out piquet, in the face of the Rebel Army. One material circumstance happened during the night. I had forgot the most essential part, the Parole and Countersign, which, when the officer of the night came around to visit the piquet, and if there had not been a more attentive memory in my Corporal, I should have made a most lamentable figure. However, all things passed on very well, and in the morning I marched off my men to their tents, not a little proud of my night's duty.

British Soldiers look with Impunity on their Yankee Recruits

The same routine went on for several days, until I began to be tired of this fatigue, and I applied to Mr. Close to procure clothing, and arms for the men, stating the danger we run of being fired on as Rebels in our Country Clothes; he hem'd and har'd for some time until my patience was quite exhausted, and I said to him, "*Sir, you command a Company in the British Army, you are not fit to command an English waggon.*" In short I said so much that if he or myself had known anything of military duty, I must have have been shot, agreeably to the Articles of War. I however soon learned better, as the secret will show.

One day as I was walking past the officers mess, (for I had already

learned so much of my duty as to find I was not yet to be admitted into the society of the commissioned officers) I heard them Huzza for the Second Battallion of Queen's Rangers; I had heard much of the Regiment as a fighting corpse, and I did not much like the sound. I made up my mind, if possible, to change into the Regiment with my relations, lying along side of us, and the morning we were ordered for marching I left my tent for the purpose of making the application, and had got part of the way to my friend's tent, when, I beheld the Col. of that Regiment mount his horse and begin to belay the Sentinel at his Marque, over the head and shoulders of the man, with great violence. I looked with astonishment for a short time, marched back to my tent, and when the orders were given to march, I threw my knapsack on my back and marched, thanking my stars that I had escaped falling under the discipline of such a savage in the shape of a Colonel of a British Regiment. The Regiment marched to New York and went immediately on board ship. Here I had for the last time a sight of Captain Lockwood.

I remonstrated with him, but he replied, "That all was going on well, that he should be with the Regiment in a few days, and bring my commission with him." I had not a moment longer to spare, was hurried on board, we sailed, and the next morning landed at Amboy, marched out to a place called Strawberry Hill, our small Regiment was drawn up in front of the Encampment of the Queen's Rangers, the Non-Commissioned in front of the men, and a general selection took place, those fit for grenadiers, were set apart for the Grenadier Company, then the Light Infantry, then a Company was selected for a Highland Company. The officers were Captain McAlpine, Lieutenant Close, Simpson, and Ensign Shaw. (Afterwards General Shaw of

Manuscript of Colonel Jarvis—Born in 1756

Upper Canada) The rest of the officers were placed on half pay—or joined other Regiments;—After the officers by Seniority, had made a selection of the Non-Commissioned Officers, a Captain McKay came up to me, asked my name, age, etc., and if *I could write*. I happened to have a roll of Captain Lockwood's Company in my pocket, which I took and handed him, after examining it, he folded it up, handed it me back, called a "Sergeant Purday to show me his Tent."

Experiences of an American inside the British Lines

Here all my hopes of a Commission was at an end. I was a perfect stranger to every individual around me, not a friend to advise, or ask council of, no money in my pocket, the most inexperienced, either of men or manners, of any almost in existence. Think what my feelings were at this time. I have often wondered how I survived the disappointment. I however, made up my mind that if I ever had an opportunity to meet the enemy—that I would merit a Commission, and I applied myself strictly to my duty, and soon merited the notice of my officers who placed confidence in me. A few days after there was a great desertion of the Non-Commissioners, and amongst the rest Sergeant Purday of our Company. From this circumstance, all the duty of the Company devolved upon me, such as making out returns for provisions, clothing, morning reports, master rolls, etc., as the other Sergeant was a drunken useless fellow, who, by the by, I recognized as once having seen him in Danbury a recruiting for the American Army.

There is one circumstance I cannot avoid mentioning, as it mortified my pride exceedingly. I had been on duty during the night, and as the duty was arduous, I came off duty very much fatigued. I called at Captain McKay's tent to have him sign some

return, I did expect he would have asked me to sit down, I waited some time and then sat down. I had not sat long before Captain McKay said in a mild tone of voice, "Sergeant Jarvis, it is very improper for you to sit in the presence of your officer, without you are desired to do so." I must leave the reader to judge of my feelings at this rebuke, altho so mildly given, I arose from my seat and replied, Sir, I am a young soldier, and I am very tired, having been on duty all night. I was in hopes you would have desired me *to sit down*, but as you did not, I was in some measure under the necessity, but I shall know better in future;—he signed the return and I returned to my tent. In a few days there was an order for marching with four days' provisions for each man. The Army marched into the country. We fell in with the enemy on our route, and a partial engagement took place, and we had one man killed;—and I had a narrow escape myself. I was standing in the angle of the fence, a rifleman was in the opposite field on horseback, at the time we were forming along the fence. He dismounted, placed his rifle across his horse, fired. The ball struck direct in the angle of the fence opposite my face, and the splinters flew about my head and eyes. The Army marched to Brunswick and then returned again to our old quarters.

On the British Firing Line in the Battle of Brandywine

There was nothing of moment after this movement until we embarked for an expedition—the fleet sailed, as it appeared afterwards for the Chesapeake and about the middle of August we landed at the head of Elk River, where the Army encamped for some days, and here was my first exploit. I commanded the out piquet, and at daylight in the morning a body of American horse charged my Piquet. I repulsed them and took

An American's Experience in the British Army

one Dragoon, which I secured as well as his horse, and which I took to camp with me when relieved. I was sent with my prisoner to General Howe's quarters, when the prisoner was sent to the Provost, the horse and appointments given to me, which I took back to the Regiment and which I was soon relieved of by Captain McKay taking to himself. This was an act of injustice which I did not much like but thought best to put up with it. There was little to notice after this until the action at Brandywine; The Queen's Rangers led the Division of General Kuephausen.

We came in sight of the enemy at sunrise. The first discharge of the enemy killed the horse of Major Grymes, who was leading the column, and wounded two men in the Division directly in my front, and in a few moments the Regiment became warmly engaged and several of our officers were badly wounded. None but the Rangers and Ferguson's Riflemen, were as yet engaged; the enemy retired, and there was a cessation for a short time, to reconnoiter the enemy, who had taken up their position in a wood which skirted the road that led down to the River. The Rangers were ordered to advance, and drive the enemy from that position. We marched from the right of Companys, by files, entered the wood, and drove the enemy from it, into an open field where there was a large body of the enemy formed. Major Wymes, who commanded the Rangers, ordered the Regiment to halt and cover themselves behind the trees, but the right of the Regiment was hotly engaged with the enemy, and Captain Dunlap came to Major Wymes, and requested him to let the Regiment charge or the two Companies would be cut off. The Major then ordered the Adjutant (Ormand) who was very glad of the opportunity, to desire the troops in our rear to support him, ordered the Regiment to charge. At this instant, my pantaloons received a wound, and

I don't hesitate to say that I should been very well pleased to have seen a little blood also. The enemy stood until we came near to bayonet points, then gave us a volley and retired across the Brandywine. Captain Williams and Captain Murden were killed, and many of the officers were wounded in this conflict. The Brandywine on each side was skirted with wood, in which the Rangers took shelter, whilst our artillery were playing upon a half moon battery on the other side of the River which guarded the only fording place where our Army could cross. In this position we remained waiting for General Howe to commence his attack on the right flank of General Washington's main Army.

Whilst in this situation Captain Agnew was wounded, of which wound he was ever after a cripple. Several other men were also wounded by the riflemen from the other side. Captain Agnew (he was only Lieutenant at this time) had behaved very gallantly when we drove the enemy. I saw him plunge his bayonet into the fellow who had killed Captain Murden the minute before. General Howe commenced his attack late in the afternoon, and this was the signal for our Division to advance. The Fourth Regiment led the Column, and the Queen's Rangers followed, the battery playing upon us with grape shot, which did much execution. The water took us up to our breasts, and was much stained with blood, before the battery was carried and the guns turned upon the enemy. Immediately after our Regiment had crossed, two Companies (the Grenadiers and Capt. McKay's) was ordered to move to the left and take possession of a hill which the enemy was retiring from, and wait there until further orders. From the eminence we had a most extensive view of the American Army, and we saw our brave comrades cutting them up in great style. The battle lasted until

Manuscript of Colonel Jarvis—Born in 1756

dark, when the enemy retreated and left us masters of the field. We were then ordered to leave our position and join our Regiment. We did so and took up our night's lodgings on the field of the battle, which was strewn with dead bodies of the enemy.

Fighting at Germantown under the Colors of the King

In this day's hard fought action, the Queen's Rangers' loss in killed and wounded were seventy-five out of two hundred fifty rank and file which composed our strength in the morning. Why the army did not the next day pursue the enemy, and bring them to action, I must leave to wiser heads than mine, to give a reason, but so it was. We remained encamped the whole of the next day, and gave the enemy an opportunity to rally his forces, get re-inforcements and take up a position to attack us, which they did, at Germantown, where our Army had encamped, sending our sick and wounded into Philadelphia. At this battle the enemy were again defeated, and left us in possession of the field. On the morning of this action, I was under a course of physic, and was ordered to remain in camp, and had not the honor of sharing in the victory of this day's battle; I was so reduced from fatigue that I was returned, unfit for duty, and was ordered to the Hospital, and the next day took my quarters at the Hospital in Philadelphia. I was not so ill but that I could walk about, and the Doctors allowed me to take a walk about the City every day. Whether they had any orders from my officers on that behalf I know not, but so it was when others had not the same indulgence. I remained in the Hospital until I thought I was able to undergo the fatigue of duty and join my Regiment.

A few days after joining the Regiment, made an excursion into the Jerseys, as far as Hattenfeld, but it was ordered that I should remain at

the quarters of the Regiment, which was at Kingsonton. The next day Captain Dunlap returned to the quarters ordering every man that was able to march to join the Regiment, and myself among the rest. It was near dark when we got to the Regiment. I was most dreadfully fatigued, and lay down to rest. I had hardly time to take my refreshment before the Regiment was ordered under arms, where we remained for several hours in a storm of hail and snow, and at last ordered to retrace our steps towards Philadelphia. I had marched but a few miles before a pain attacked my limbs, to that degree, that I could with difficulty walk, and soon fell in the rear of the Regiment, expecting every minute to fall into the hands of the enemy. I had the good luck to get up with the Regiment, who had encamped at a plantation on the banks of the Delaware. More dead than alive, the ground covered with snow, I scrambled to the barn, got into a large mow of straw, covered myself up with straw, and fell asleep and did not wake until daylight in the morning. On awaking, I heard Major Simcoe (who had a short time before, and while I was in the Hospital) succeeded Major Wymes in the command of the Regiment, and some of the officers in another part of the barn, but hid from my sight. They soon left the barn, and left standing on a beam within my reach a bottle partly filled with good madeira. I soon demolished the contents and set the bottle up as before, left the barn also, and joined my Company. In the course of the day the Americans attacked us, and we had a smart brush with them, had a Sergeant (McPherson of the Grenadiers) and several men wounded. In the evening we crossed over to Kensington and took up our old quarters.

Intimate Insight into Life in the British Army in America

I had forgot to mention one circumstance, which happened at Brandy-

An American's Experience in the British Army

wine, after the Regiment had crossed and was charging with enemy, Lieutenant Close found it more safe to take shelter under the walls of the battery, where he fell asleep until he was discovered by the Provost Marshal, and reported to the Regiment as killed. A party was sent out to bring him to camp, who awoke him from his slumbers. He came to the Regiment, but was obliged to leave it. He never did duty again in the Regiment. Captain McAlpine also left the Regiment for some cause,—a change took place in the Companies, Captain McKay took command of the Highland Company, Captain Stephenson of the Light Infantry. After the death of Captain Williams, Lieutenant McGill was promoted to Captain (now at York, U. C.) and took command of McKay's Company. Lt. Shank Captain of Captain Murden's Company; Lt. Agnew to be Captain, but did no duty. The Regiment during the winter had severe duty once or twice every week to cover the market people coming to market, and often we had long marches and frequent skirmishes with the enemy, and took a good many prisoners during the winter. I found Captain McGill the same indulgent commanding officer as I found in Captain McKay, and I found my situation as pleasant as I could have expected, according to the discipline of the Army, and I looked forward for more favorable prospects in the future. It would be endless to enumerate the different actions which took place, but there were too many, in which the Regiment gained great applause at White Marsh, and afterwards at Parker's Bridge, at both of which places we took and killed a good many.

Accuses General Howe of Responsibility for England's Downfall

In short we were continually engaged with the enemy more or less, and had General Howe during the winter, instead of gambling with

the officers every night, to the utter ruin of many of them, attacked General Washington at the Valley Forge, where he might have done, the event of the War would have been very different, but I am only relating of those actions in which I was personally concerned. During the winter Major Simcoe was promoted to the rank of Lieutenant Colonel, and a Major Ross joined the Regiment. The news of General Burgoyne's capture gave great energy to the enemy. The French also forming an alliance with the Americans, and sending troops to America put a different face on things. General Howe, after making a great display in Philadelphia, resigned the command and went home and Sir Henry Clinton took the Command in Chief, and began to make preparations for evacuating Philadelphia and marching the Army through the Jerseys up to New York, and on 18th day of June 1778, the British Army crossed the Delaware and commenced their route, the Queen's Rangers always in the rear of the line of march. I have omitted to state that before we left Philadelphia a Troop of Horse was added to the Regiment. The officers were Captain Wickham, Lieut. McKab (late of York in Upper Canada) and a Cornet Spencer from the 17th Dragoons.

Nothing of moment took place on our route until we came to Monmouth, where on the morning of the 28th of June, the Queen's Rangers met at daylight the advance army of the Americans under the command of General Lee. We had a smart brush, and Col. Simcoe was wounded. We took some prisoners and returned and joined the Army at Monmouth Court House,—Sir Henry Clinton, with five thousand of his Army attacked Lee and drove him the whole day—took and killed a great many of his men until we fell in with General Washington's whole Army, when we retreated, leaving our wounded in the

Manuscript of Colonel Jarvis—Born in 1756

enemies' hands. On commencing our retreat we had to oppose a large body of the enemy, and one of our field pieces was abandoned, and the enemy gave a shout. Lieutenant Shaw with the Highland Company wheeled about, charged the enemy, and brought off the cannon, which was ever after attached to the Regiment.

Retreating with King George's Men and Dissension in the Ranks

We continued our retreat during the whole night and came up with the main Army at Middletown, where we halted to refresh ourselves for the first time in twenty-four hours. The day of the battle was one of the hottest days I ever felt, and we lost more men by drinking cold water than were killed by the enemy. I bore the fatigue of the day very well with only having again a shot through my pantaloons, leaving the mark of the ball on the skin, or rather the powder without drawing blood. The Army continued its march, the Rangers bringing up the rear. The Army crossed over on a pontoon bridge to the lighthouse island, the Queen's Rangers embarked in flatboats and rowed up to New York and landed at Bloomingdale above New York, where we remained for some time and then crossed over to Long Island and took up our quarters at Oyster Bay. Another change had taken place in the Regiment. Major Ross had left the Regiment. Captain Armstrong promoted to the Majority, Captain McGill went to the Grenadiers and Captain Agnew got his company soon after we came to Oyster Bay.

Two of the Sergeants of the Horse (Kelly and Johnson) were convicted of plundering some of the inhabitants, was took and flogged and I was transferred from the Infantry and to the Calvary. I had for my associates a Sergeant Prior and a Sergeant McLaughlin,—from this moment I became a great favorite with Col. Simcoe, as well as all the other officers,

except Captain Wickham who became my professed enemy, and who tried to find me guilty of some neglect that he might try me by a Court Martial, but I had now learned my duty, and I put him to defiance, and the only way he had to annoy me was to keep my pay back. However, always having a good supply of necessaries, I did not want much money. Our duty during the winter was not very severe, the harbor afforded plenty of oysters. I became a favorite with some of the principal inhabitants, and if I sometimes had scanty allowance at my barracks, I knew where to go to get the best the house afforded. Here a Mr. Moffet from the 15th Regiment joined as Quarter Master, a rough, boisterous Irishman, but I knew how to humor him and we agreed very well together,—I spent the winter very pleasant. Our food was for some time rather coarse, our bread oatmeal biscuit full of maggots. Early in the Spring of 1779 the Regiment left Oyster Bay and took up our encampment above Kingsbridge, where we remained the greater part of the summer, making several excursions up the North River, as also to the Eastward.

Under Fire with the Enemy within Ten Miles of His Own Home

At one time the 17th Dragoons and the troop of Queen's Rangers went as far as Pound Ridge, within ten miles of my father's house to surprise a Regiment of Dragoons, which we effected and made great havoc amongst them, and took a great many prisoners. I was ordered to flank the party, and in doing so I had in one instance to divide my party. There was a lagoon surrounded with bushes. I took one rout and part of my men the other. When I came in sight of them I saw them cutting and slashing at a single man with a female standing by his side. I wrote up in time to save the man from much injury. I afterwards brought him and

An American's Experience in the British Army

his wife, for the female appeared to be so, and as he had no arms about him, I did not think proper to detain him a prisoner. I ordered him to remain in his house and left him. (I shall have reason to speak of this man again.)

We returned to our quarters again at Kingsbridge. A few days after this a young man by the name of Vincent gave information that a party of the enemy were at West Chester, that he had narrowly escaped being taken prisoner. Col. Simcoe with the mounted Legion, and the Rangers passed, ordering the Infantry to follow. We came up with the enemy, we were ordered to form for the charge. In the meantime as the front Division were wheeling up I saw an American Dragoon discharge his pistol; my horse's head at that moment covered my body—the ball entered his nostril, and into his mouth. The blood spouted a stream, and my horse sank upon his haunches. Col. Simcoe ordered me to the rear, and gave the word to charge; the enemy had taken post behind a stone wall, I mean their Infantry, and when our Troops came abreast, gave us a very galling fire, and Captain Wickham wheeled his horse about and put the whole in disorder, the sequence of which was that the enemy got off safe and we suffered severely, both in killed and wounded. We pursued the enemy afterwards, as far as Byram River, and here a curious circumstance happened—there was a very deep hole in the river, near the fording place, and the trumpeter of the enemy had got into it and was hanging by his horse's mane. I plunged in after him when my horse and self were several feet under water, and when I made my appearance several shots were fired at me, without effect, and the Trumpeter escaped my grasp, as there was a large body on Infantry on the top of the hill, we found it necessary to retire.

Destroying American Property with the Queen's Rangers

Soon after this a large body of the Army marched towards the White Plains. I was with a division of the Cavalry, leading the Column—Lord Cornwallis and Col. Simcoe came up to the front, and I heard Col. Simcoe say to his Lordship, "There is a fine young lad who knows Danbury well." From this I took it for granted we were going there. We, however, soon took a turn to the Saw Pits in Horse Neck and back again to our old quarters without falling in with any of the enemy. Soon after Col. Simcoe took the route up the North River, where we fell in with a party at a place, I think called Kingsferry—when we came nigh the place I received orders to charge and I followed the enemy for some distance, and altho I did not myself take any of the enemy, I cut off the retreat of a good many, which were made prisoners.

We returned to our camp in this manner. Much of our time was taken up during the summer, and in the Autumn we were moved to Staten Island, and took up our winter quarters at Richmond. Soon after our arrival at this place a quarrel ensued between Mr. Moffet, now an Ensign in the Regiment, as well as Quartermaster of the Horse, with a Lieutenant (Mr. Lawrence died in Upper Canada) Lawrence. A duel ensued and Moffet was killed. Col. Simcoe was so enraged that he would not let him be buried with the honors of war. Lieutenant Lawrence was tried by a Court Martial and Honorably Acquitted. Soon after our arrival at Staten Island an expedition was planned for destroying a number of boats that had been built for the express purpose of landing the French Army, which the Americans were expecting to arrive daily. It was composed of the Cavalry of the Queen's Rangers, the Buck's County Volunteers, and the Jersey Ds; the Buck's

Manuscript of Colonel Jarvis—Born in 1756

commanded by Captain Sanford, the others by Captain Stewart, all under the command of Col. Simcoe. The Infantry of the Rangers were to march into the country to cover our retreat. We landed at Perth Amboy, and we were to return by South Amboy.

The Troops were to have been landed by ten o'clock at night, for which purpose we left Richmond for Billip's Point so as to reach that place soon after dark. From some cause or other it was near daylight before we landed at Amboy, and we had to perform the whole journey almost the whole way by daylight. In passing through a small village, as the sun was rising, a few men with knapsacks came out of a house and our men took them for soldiers and commenced an attack, and this gave the alarm; we however proceeded on our route. We had a Frenchman in our Troop, who from his broken English said that we were French Cavalry after the boats to land the French Army. By this means we procured guides who conveyed us to where the boats were, and we had collected a good number on our way, all of which we made prisoners as soon as we came to the boats and began to destroy them. There were twenty-five beautiful barges all fixed upon carriages ready to be conveyed to any place where they would be wanted.

Terrific Conflict in which Officers almost Lose their Reason

In a few minutes the boats were in flames, and the wheels of the carriages cut to pieces, to the great dismay of the guides who had conducted us to them. We then proceeded to a place called Millstone, where we burnt a large quantity of forage, paroled several American officers which fell into our hands; burnt the goal and relieved several of our prisoners who had been confined in goal, and then commenced our retreat, and a

hazardous one it was, for by this time the whole country was alarmed, and from every house and corpse of wood we were fired upon, and at last we fell into an ambuscade, where we lost Col. Simcoe and several of our men.

I had, a few moments before, been sent to Captain Sanford who formed our rear guard, with orders, when I heard the firing commence, and on my return I had to charge through the enemy; few of their pieces had got reloaded and I escaped unhurt. I pursued as fast as my horse would carry me to the front to make my report, but I could see nothing of Col. Simcoe. I rode back and forth enquiring for the Colonel. At last the Surgeon said, "He is dead." Dead said I, and are we going to leave him in the hands of the enemy, and I tried to get the men to turn about for the purpose of bringing him off, but I could not succeed. My gallant Captain Wickham was riding about like a mad man, had lost his helmet and seemed to have lost his reason altogether.

By this time Captain Sanford had assumed the command, and we had got into some degree of order—we had by this time reached Brunswick Plains, and the enemy had nearly surrounded us—was enclosing us fast—Captain Stewart, our principal guide, had received a slight wound in the hand, had got confused; our men every moment falling, and as it was announced that the road to South Amboy was our route, no person could show us the way. I had already taken charge of Captain Wickham's Division. The Surgeon got frightened, leaped off his horse, put his white handkerchief on the point of his sword, and ran towards the enemy, and a Sergeant Carhart followed him. In a few minutes we saw him returning and calling to Captain Sanford. We ordered a halt. He came up and said to Captain Sanford, "Sir, the enemy will receive the flag, but insist that you go back to the

An American's Experience in the British Army

ground from which I left you." Pray Sir, says Captain Sanford, who ordered you to go with a flag, go back Sir to the enemy, and make your own terms. I shall have nothing to do with you." By this time we had little space to act upon. I saw the situation in which we were placed, and I sent Sergeant McLaughlin to tell Captain Sanford that if he did not allow us to charge the enemy, we should all be prisoners in ten minutes.

Cutting through the American Ranks in Reckless Onslaught

The word was given and we cut our way thro the enemy and in doing so we fell upon the road we had been seeking for and we pushed forward. In pursuing our route we fell in with two men armed; one fired and killed a Corporal Maloy, of our Troop. The man was immediately killed—the other taken prisoner and ordered to run alongside the horses. I was ordered to bring up the rear. One of Captain Stewart's Dragoons had his thigh broken by a shot, and it was difficult for him to keep up with the Troops, who were making the best of their way. He was fearful of falling into the hands of the enemy, and begged of me not to leave him. I then put the prisoner behind him on his horse, and remained with them until our Troops were long out of sight. I then told the wounded man that I would stay with him no longer. You have got your pistol and can defend yourself if the prisoner should make any attempt to resist you, and overtake us as fast as you can. I then left them, and before I had overtaken the Troops they had come up with the Infantry and made a halt—the wounded man also soon came up, but the prisoner had made his escape. It is impossible to describe the dismay of our Troops when they found we had returned without our Colonel.

Narrow Escape from Americans and Dreary Journey to Safety

On our arrival at the place for embarking we found the boats ready. I was ordered to see all the horses on board, and I did not attempt embarking my own horse until the last boat, when he refused to leap into the boat. I gave the bridle to a sailor and jumped into the water, to urge the horse in. At that moment order was given to push off and wait for no man. The sailor dropped the bridle, took to his oar—the boat rowed away leaving myself and horse standing in the water—the enemy marching down to the shore. I mounted my horse with the intent to swim him after the boat, but I saw one boat yet at the shore. I rode to it, threw my saddle and bridle into the boat, and jumped on board, and had the mortification to see the enemy take possession of the animal that had so many times carried me through great danger and difficulties. I was happy indeed to have escaped myself. We landed at Billip's Point, and we had a dreary and melancholy night's walk to Richmond—and took up our old quarters. The day after we got to Richmond, a man came from the enemy and brought intelligence that Col. Simcoe was alive, his horse having fell on him and stunted him. This was joyful news to all the Regiment. His servant, McGill (died in Upper Canada a Captain in the Army) went out and took care of him while a prisoner. They confined him in goal, where Col. Billip, a Loyalist was chained to the floor. Sir Henry Clinton with a part of the Army embarked for Charlestown, as it afterwards appeared, and the Infantry of the Rangers were also in orders, and the baggage was on board—but they were ordered to be re-landed, and the fleet sailed without them, and the Regiment remained at Richmond all winter. Col. Simcoe was soon exchanged, and joined the Regiment. The morning after his arrival he

Manuscript of Colonel Jarvis—Born in 1756

came down to where the Cavalry was quartered—some of the officers with him—he said to me, “Jarvis, come to my quarters at 12:00 o’clock.” I accordingly was there at the time. He then walked out of the Fort into the open field, out of hearing of any person, and began questioning me as to all circumstances which took place after he fell. To all of his questions I gave as correct account as I possibly could, and quite to his satisfaction, and then he said, “Jarvis, how did the officers behave?” I answered, as officers ought to on such occasions. “Well, but Jarvis, how did Captain Wickham behave?” Very well, said I. “Did he, Jarvis, did he?” Colonel, said I, do you think it possible that an officer of the Rangers can behave ill? He looked at me with his piercing eyes and said, “You Yankey dog, you Yankey dog.” After a short pause he clapped his hand on my shoulder saying, “You are right, you are right, my good fellow. Take care of yourself, you are a brave fellow.” He then dismissed me and I returned to my quarters.

Dragging Cannon Across New York Harbor on Ice in 1780

After Mr. Moffet had obtained his Ensigney in the Regiment I was allowed to do the duty of Quarter-Master, for which Mr. Moffet allowed me a shilling a day, besides my other pay, and I still continued to do that duty. My friend Wickham one day sent for me, and said, “Jarvis, if you will draw a petition to the Colonel for the appointment of Quarter-Master, I and Mr. McNab will recommend you for it.” This was so extraordinary a circumstance that I hardly thought him sincere, yet I lost not a moment, and after he had done as he promised, I waited on the Colonel and presented it. He read it with great attention, for in my petition I had stated the circumstance of my joining the British Army, the loyalty of my family, and the promise and expectation made me

when I first joined. After some little hesitating he said, “Jarvis, I have long had it in contemplation of giving you promotion, and I am sorry that I cannot do so now, but I have promised it to McGill. His late conduct towards me when in goal, and his long services with me, has induced me to do so, but you may rest assured that I will take the first opportunity in providing for you.” This was rather a disappointment that I did not look for, but I bore it with fortitude.

Ever after this Captain Wickham appeared to be a very sincere friend, made me a companion more than anything else, ever after so long as I remained in the Regiment. The winter of 1780 was a most severe one; the harbor of New York was even so frozen that cannon were brought from New York to Staten Island upon the ice, and during the winter a body of the enemy crossed from the Jerseys to Staten Island and invested our post. At the Narrows the cold was intense, and after remaining two nights and losing about forty men frozen to death, they returned to the Jerseys. Our Regiment from Richmond pursued them and took some prisoners. Whilst the enemy remained on the Island we were entirely cut off from any assistance from the rest of our forces, and were obliged to make such arrangements best calculated for our defence.

The enemy thought best however not to approach us. Soon after this, a plan was formed to take General Washington, who lay some distance from New York, and rather attacked from his Army so as to make the attempt practicable. The 17th Light Horse and the Cavalry of the Queen’s Rangers were designed for this service, and we marched from Staten Island to New York upon the ice, and took up our quarters at the Bull’s Head, which at that time was quite out of the City. The time arrived and we crossed over to Elizabethtown Point, and after marching some dis-

An American's Experience in the British Army

tance in the country, returned back without making any attempt, and thus the affair ended, much to my disappointment, for I had set my heart on this expedition, as I was to have taken charge of the General after he had fallen into our hands. We remained at the Bull's head for several weeks, until the harbor opened so as to return to Staten Island by water, during which time our Dragoons did much injury to the inhabitants, but I generally found out the perpetrators, and had them punished. One robbery they committed is of so singular a nature that I cannot avoid mentioning it.

With British Cavalry in the Surrender of Charlestown

They went one Sunday to some Dutch parson's house, and finding nothing that suited them, they stole a stove and carried it off, for which the Commander-in-chief made Mr. McNab, the Commanding Officer (for my friend Wickham was not with us) pay for the stove, which he did before we were allowed to join the Regiment, which we did some time in the latter month of March. Soon after our joining, I was sent for to the Colonel's quarters, when I was informed that the Regiment were going to embark; the Cavalry were to remain behind. He then asked me, "if I had any inclination to go with the Regiment." I expressed a desire to go. He said, "Well, my boy, *you shall go*, and you shall have a command. You shall have fourteen men; those you shall chose out of the whole Troop, and I will place Sergeant McPherson (this was the Brother of the one that was killed before we left Philadelphia) with fourteen rifle men to act in conjunction with you," and he ordered me at the same time to make out a list of the men I chose to take with me. I did so and gave it to him. He examined it and said, "You have made a very good choice; you have left out Maloy, I thought he

would have been your first choice." So he would, Sir, if we should be fighting the whole time, but he will always be getting into some scrape and disgrace me and my party. However I found it was the wish of the Colonel and I at last consented.

We soon embarked, me with my men, saddles and appointments, and after a passage of fourteen or fifteen days, we arrived at Charlestown. We landed on James Island, crossed over above the City, and took up our quarters at the Quarter House six miles from Charlestown. I lost no time in procuring such horses as fell in my way, and had my men mounted and our business was to make patrols into the country, but we never came in contact with any of the enemy during the siege, which continued until the 12th of May. After the town surrendered, the Rangers marched into the country as far as Four Hole, when the Infantry halted and Captain Saunders, with my Cavalry, pushed considerable farther and passed for Americans, being dressed in green. At one Plantation we took a number of horses, and among the rest a very fine stud horse, which I mounted and rode for a few miles, when he at once halted and I could hardly get him along. He had not been rode for many years, and I foundered him, and was obliged to take to my former horse. There was little to excite the attention of the reader during our stay.

We took up our quarters at Dorchester for some time. The people from the back country coming in daily and taking the Oath of Allegiance, and before we left Charlestown it was again to appearance a British Colony. We soon left Charlestown and sailed for New York. During the passage I discovered there was a negro man and woman on board, and when we came to Staten Island I landed with my men and horses whilst the Regiment proceeded on and joined Colonel Kuephausen, who was

Manuscript of Colonel Jarvis—Born in 1756

in the Jerseys, and during the absence of the Regiment, two men, who it appeared had a claim on them for their support at least, came to me and said there was a man who wished to purchase the negroes. My answer was not to do anything without the approbation of Mr. McGill, who was the only officer then in the Garrison. They obtained his approbation, and they sold them, and the only hand I had in the matter was to divide the money between them, and I thought nothing more of the matter for some time.

British Soldiers Search for Hidden Money on American Estates

During the forepart of the season we were incamped at Kingsbridge, at a place called Odle's Hill, where one day some of the soldiers in finding a mouse under a stone they were induced to search for more. At last they undertook to turn over a large one, and at last succeeded, when there was the greatest shout and scabbling imaginable. There was a deposit of money to the amount of many hundreds of dollars, which was soon distributed among the soldiers according to their good fortune in collecting what came within his grasp. The money was claimed by Mr. Odle, the proprietor of the farm, but he got no satisfaction. Col. Simcoe however told him if he had any more money out of doors to bring it into the house and it should be safe. He went and pulled down a place in the stone fence, and took out a jar full of gold, the consequence of which was that he had hardly a rod of stone wall about his farm that was not examined before daylight the next morning.

We remained in this situation until the fate of Major Andre, where we were waiting until his return to take possession of the Fort at West Point, when we were removed on to Long Island, which we traversed from New York until we arrived at East Hampton. Here we remained until our

Army evacuated Rhode Island, after the French Fleet had returned from that place, when the Queen's Rangers retired as far as Oyster Bay; the Cavalry remained at Satauket, under the commanding of the Commanding Officer of the 17th Dragoons. Here again I met with the most discouraging circumstances, and it was a wonder how I escaped. I had been taking orders, and, as is the custom, was proceeding to my officer's quarters to show him the orders, when, after going some distance on my way, I heard some person calling after me. I turned around and saw an officer and two men following me, and as they came up to me the Officer said, "Is this the man?" They replied "Yes," and without giving me time to reply.

Jealous English Officers Cause Court Martial of American Recruit

I was ordered to the Guard House, where I remained all night. However, I was released the next morning—thro the interference of my Officer. Some person had killed a hog belonging to a Colonel Floid, and these two men declared that I was the person. I applied for a Court Martial to prove my innocence, but this I did not obtain. Soon after we were ordered to join the Regiment, and as we came near the town of Oyster Bay, I was sent forward to announce their approach. As I entered the town, I was congratulated by all the Officers on my promotion. "I was not in orders," they said, "but no doubt I should be the next day, as they had seen the orders from Headquarters."

I therefore proceeded to Colonel's quarters with a delightful sensation, expecting the same congratulation from him, but alas it was quite a different reception that I met with, for after I had delivered my message, he with a stern countenance said to me, "Young man, what is this you have been doing? I understand you have been selling negroes." Indeed, Sir, I have not, I replied. Some of the men

An American's Experience in the British Army

have, not me, I assure you Sir. His only reply was, "Go to your Troop, Sir." I obeyed. The Cavalry was camped at a village about two miles from Oyster Bay. Imagine what my feelings must have been at this moment, but I had yet a much greater mortification still. The next day there was a Court of Enquiry, a Captain and two Subalterns. I was examined; I told my story, as it happened, except how far Mr. McGill was concerned, but one of the men flatly told the Court that McGill had given them leave to sell the negroes.

I was then again called and examined as to that fact. To this I refused to answer. Whatever I have done I must be the sufferer, for I would say nothing that would in the least injure Mr. McGill. "Captain Shank, who was President of the Court, urged me to say how far the story given by the men was correct, for it might do away with the charge against myself, otherwise he feared it would be the means of my losing my promotion." I replied that I had already said what I should say, let the consequence be what it would. On this the Court broke up, and what report they made I never knew, but I rather suspect that McGill must have been examined, and denied giving any such leave from what took place afterwards. The next morning after the men were assembled for the morning parade, Colonel Simcoe called me to him, and laying his head down on the neck of his horse gave me one of the most severe reprimands I believe man ever received, and told me decidedly "that I had lost my promotion and his countenance forever. Go Sir and join your Troop." I returned to my duty more dead than alive. One of the Officers, I think it was Mr. McNab, was going to New York the next day, and I took the opportunity of writing my relation, a Mr. Jarvis who was in the Commissariat, and in my letter gave him a true statement of facts, enjoining him to secrecy; that

he was not to divulge it until after my death—for I determined the first action that gave me opportunity, either to sacrifice my life or retrieve my character—at all events I do not think I should long have survived. I lost my appetite, and my sleep went from me; my frame decayed, and in a few days I was a complete skeleton.

One evening after parade was dismissed, both Mr. McGill and myself were desired to attend the Colonel, and after all the officers had retired, he then taxed McGill of giving the men liberty to sell the negroes, which he denied. The Colonel then turned to me and said, "Jarvis, did he not give them leave?" I replied, No Sir. He gave me one of those stern looks, which spoke volumes, taking a letter from his pocket handed it to me saying, "Is not that your handwriting?" I was thunderstruck, and it was some time before I could answer. "Speak Sir, speak, is that your letter?" and "Is what you have stated true?" I then answered, Sir it is my letter, and since I must answer, the contents are true, but Sir give me leave to say that if I could have imagined that my friend would have betrayed me and the confidence that I had placed in him, I would have suffered death before I would have wrote that letter now in my hands. "Go to your Troop," was his reply. What he said to Mr. McGill I forbear mentioning.

Defeat of Conspiracy and Promotion of American Soldier

Not long after this I was one evening ruminating over my misfortunes, in a retired part of our quarters, seated upon a stone in the dusk of the evening, when I was accosted by a voice familiar to me, and embracing me round the neck at the same time, saying, "Dear Jarvis, *all is well again*, I am sent as a messenger of peace to you, but you must keep it secret that *I give* you the information. Captain McKay has sent me to say to you that your promotion will take place". I

Manuscript of Colonel Jarvis—Born in 1756

was so much overcome that it was some time before I could speak, and when I did, I said to McPherson, don't sport with my wounded feelings, I have already received my sentence, and I shall not long survive it. "I tell you Jarvis I have said nothing but the truth." "Mind what I have said, don't let it be known that I gave you the good news." He then left me and returned to his Company. In a few days the Regiment again marched and crossed over to Staten Island, and took up our old quarters at Richmond. The next morning I saw my name in the orderly book as QuarterMaster in Captain Saunders' Troops, with orders for embarkation.

An expedition was formed under General Leslie, of Virginia, and amongst the Troops that composed the Army was one Troop of the 17th Light Dragoons, Captain Saunders, Lieutenant Wellson, Cornet Merritt, QuarterMaster Jarvis and a few men of the old Troop of the Queen's Rangers. Captain Saunders was formerly from Virginia and he went to that place for the purpose of recruiting; clothing, saddles and appointment were placed under my care for the completion of a full Troop of fifty strong. We soon sailed and Captain Saunders with the other Officers and men landed at Norfolk, and marched to that part of the country where he had formerly resided. I was ordered to remain with the baggage until further orders. Captain Saunders, after traversing the country, and procuring a number of very fine horses, took up his quarters at Kemp's Landing, to which place I was ordered with the baggage and stores. I had hardly got into good quarters before we were again ordered to march and we supposed for, a short expedition only—and a Company took possession of my quarters in my absence, but was to surrender them on my return, which however never took place. We embarked for Charlestown, myself, men, stores and horses in one vessel and the

Officers in another. On our leaving Norfolk Captain Saunders had plundered more horses than he was allowed to put on board. He, therefore, distributed them to his Officers and among the rest, gave me a very fine horse.

At sea we had very boisterous weather, our vessel sprang a leak—never so crazy a vessel went to sea. To save our lives, I threw thirty fine horses overboard, but saved every Officer a horse. With great difficulty we got safe into port; every person was down working at the pumps, and had it not been for a fortunate circumstance of having several green ox hides on board, which we cut up in strips, and the Captain lashing himself over-board and nailing the strips over the seams of the vessel, by which means with great exertion we could keep the water under, we would have been lost. We arrived safe at Charlestown, when Captain Saunders with what men he had was ordered to Georgetown. I was ordered to remain with the Stores, set the sailors at work making new clothing for recruits and also to recruit, but left no money with me to recruit with. The consequence was, I never recruited a man for him whilst I remained in the Troop. He also took the horse from me, with a promise to give me another when I joined him again, but as that was not the case I lost my horse. About the time that Captain Saunders went to Georgetown, a party of Americans dashed into the town, and made Colonel Campbell of the King's American Regiment, who quartered outside the Garrison, a prisoner, and paroled him, and retired without any other person falling into their hands. There was at the time a Captain Campbell who was recruiting a Troop of Dragoons at Georgetown, and who brought the news of Colonel Campbell's capture to Charlestown. He wished to remain at Charlestown in some business.

An American's Experience in the British Army

He procured an order for me to proceed to Georgetown, with the orders vesting Captain Saunders with the Command of the Garrison, and giving Major Grant of the King's Americans leave of absence. Captain Campbell kept one horse, and sent his servant with one as a guide. I proceeded on and met an escort at the Santee, who conducted me to Georgetown, where I delivered my dispatches to Captain Saunders, and the next morning returned in company with Colonel Campbell and Major Grant under an escort as far as the Santee on our return. After our arrival at Charlestown, Major Grant made me a present of a little horse, of little value, which I afterwards exchanged with a Hessian Officer for a very smart white pony. This enabled me to ride about the country and amuse myself, overseeing my squad of Tailors at work, and at the same time instructing them in the carbine exercise.

Experiences in Charge of Uniforms of King's Fighters

Soon after this Captain Campbell made another visit to Charlestown, and was to take back with him several suits of clothing, saddles and appointments for some recruit Captain Saunders had obtained. They were to go part of the way by water, and I had them put on board for that purpose, and called on Captain Campbell to sign a voucher for them. He flew in a violent passion, swore bitterly that he would do no such thing. You won't Sir was my only reply, I shall order them on shore again, and left him for that purpose, but when the men came on shore, and before the things were landed, Captain Campbell came down to the shore in company with some of the Officers of the 71st Regiment, and I heard Captain Campbell say to them that there was the most obstinate fellow (meaning me) he ever saw in his life, and mentioned the circumstance. One of the gentle-

men replied in these words, "I'll tell you what Campbell, the young gentleman knows his duty. Suppose on the way, those appointments, etc. should fall into the hands of the enemy, and he should be called upon for a statement of the stores in his charge, and he could procure no vouchers, the consequence would be that he would be broke and dismissed the service."

After some explanation and a promise to indemnify me in case they should be lost and to get Captain Saunders' certificate and send me, I ordered them on board the vessel again, and I soon received Captain Saunderson's certificate of his receiving them, and all was well. A short time after this I was one day taking my usual ride, I fell in with a Major Fraser (he had formerly belonged to the Rangers) who after the usual salutations said, "Jarvis, I am glad to fall in with you. I have been wishing to see you for some days." I wish I had known it Major, I hope it was nothing disagreeable, for of late I have only got out on one difficulty to fall into another." "No, I assure you," he said. "It was on a subject I hope much to your advantage." I am happy to hear it I replied, as I have been a useless animal for this some time past, and I should like for some employment for the good of the service than I am now engaged in. He then said, "Captain Campbell has been speaking with me, and requested me to solicit you to accept a Lieutenancy in his Troop."

Commanding Cavalry and procuring Sheep for British Soldiers

This was a matter so unexpected that I could hardly think him in earnest, and then mentioned the circumstance which happened at our last interview. "Perhaps that is the very cause why he is so desirous for you to join him." After some enquiry on what establishment his Troop was raised, and his advice how he thought I should act on a matter

Manuscript of Colonel Jarvis—Born in 1756

of such consequence, he "advised me to write to my Commanding Officer, who no doubt would give me such advice as would be acceptable to me," and if he gives you leave, I advise you by all means to accept of Captain Campbell's offer." I wrote to Captain Saunders, received a favorable answer, called on Captain Campbell, who went with me to the Inspector General's office, had my warrant made out and put in General orders until the Commander-in-Chief should signify his pleasure, to whom a recommendation was sent, and which was by him confirmed. Captain Campbell furnished me with plenty of money, and I earnestly set about recruiting, and in a short time we mustered twenty-six Dragoons with which number we were ordered to take the field, after procuring horses and appointments. This was at the time that Lord Rawden fought the Americans and defeated them at Camden, and the first service I performed was to escort Colonel Balfour to the Santee where we met Lord Rawden.

After having an interview with his and after having an interview with his Lordship, we returned to Charlestown and his Lordship, after disposing of his sick and wounded, proceeded with the Army to relieve our post at Ninety-Six which was closely besieged by the Americans. In the meantime, a re-inforcement of three Regiments arrived from England, the 3rd, 10th and 30th Regiments. The 19th Regiment, Captain Saunders' Troop, which had been removed from Georgetown, and Captain Campbell's Troop were ordered to Monks' Corner to relieve the Garrison there, who went on to join Lord Rawden. At this point the Commissary, who wished to join his Lordship, invested me as Commissary, and gave me possession of the Stores, and for some time I was both Commissary and Commanding Officer of the Cavalry, and during that period I marched into the country and procured a large

drove of beefs and sheep for the Army, which so pleased General Coats who commanded, that he urged me strongly to take a commission in his Regiment, but for sundry motives, not worth mentioning here, I declined. I continued for some weeks to perform this double duty, but found too fatiguing to discharge both. I wrote to the Commissary General to send a person to relieve me. At this time we were re-inforced with the South Carolina Regiment, who for their gallant conduct at Camden, were made Cavalry. This re-inforcement made the Cavalry of great consequence at this post, and we had soon an opportunity to try our mettle.

Scouting with Redcoat Dragoons on Trail of Americans

General Coats had received intelligence that the enemy intended an attack upon our position at two places at the same time, and in a very short period. I was sent for by the General, who directed me to take four Dragoons and a few Militia and proceeded on the road that lead to Charlestown, and go until I should fall in with the enemy, if they were between Monks' Corner and Goose Creek. I set off a little before sunset in a heavy shower of rain, and before I had proceeded far found that my Militia men had left me, and I was reduced to my four Dragoons, but as my object was intelligence more than fighting I proceeded on. I soon discovered six or eight men advancing towards me, and when they came to a certain distance, challenged me. I said a friend. "What friend?" To the King. At this declaration one of them dismounted and placed his rifle across his horse. I charged, his rifle missed fire. He mounted and with his comrades dashed into the woods. I soon came up with him, and by a well directed stroke laid him in the dust. I ordered my man to secure him, and push forward after the rest. I had nearly overtaken another, when my

An American's Experience in the British Army

horse, unfortunately, got entangled in a grape vine, and the man escaped; as the day was so far spent, I could not see to pursue the enemy any further.

I set to camp with my prisoner, and gave him up to the General. He confirmed the information before received. It was my turn for duty that night, and my orders were to patrol on the road leading to the Santee, and I did so, but discovered none of the enemy during the night, but in the morning about sunrise I discovered that a large body of men had approached near the Garrison, and had taken off the road to gain our right flank. I galloped back as fast as I could, but before I reached the Camp the enemy had drove in our Sentinels, and were destroying the bridge to prevent our retreat on that route, and then they retraced their steps and took up their position on the road that lead to the Santee. We remained idle during the fore part of the day, but hearing that the American Horse were at a plantation, and their horses were running loose about the field, Major Fraser, of the South Carolina Dragoons, was ordered with the whole Cavalry to proceed and reconnoiter the Troop. I commanded (for Captain Campbell was absent) led, except the advance guard commanded by an Officer. We soon came in sight of the enemy and charged. The Officer with the advance—his horse fell and threw his rider—I said to Major Fraser, I'll take charge of the advance, did not wait to hear any reply, but set off. I rode a very fleet horse and soon gained the advance, and pressed hard on the enemy, who left the road and took the woods. I soon came up with one, and my Corporal on the other side, and we both made a blow at the same time and gave the fellow his quarters. I heard a shout in my rear, looked round, and found myself in the rear of a large body of the enemy. In wheeling my horse round I broke my stirrup leather and came to the ground.

Encounter with Revolutionists and a Flag of Truce

However I recovered my seat and then pressed to regain the front of the enemy, or I must be taken prisoner, and I was indebted to the fleetness of my horse for my escape. I had nearly gained the front of the enemy before they discovered me, and they called me to surrender; not yet, thinks I, a little more running first. I found I gained fast upon our Troops, who were retreating in good order. I recovered the roads a few rods in front of the enemy. They fired several shots after me without injury. We met our Infantry with a piece of ordnance. We wheeled about and checked the enemy, and then retired to Camp. By this time our piquet at the bridge leading to Charlestown were attacked, and I was ordered to direct Captain Bell, who commanded, to retire, which he did with no other loss than one of his Officers slightly wounded in the arm, which he was very fond of carrying in a sling for a long time after. We remained until night, when we burned our stores, and commenced our retreat through a bye road that the enemy had no knowledge of. During the night the Troops got separated, and the waggon which were heavily loaded broke down one after the other. Captain Campbell, Paymaster of the 19th Regiment, with the Military chest fell into the enemy's hands, with all the heavy baggage of the Regiment. We proceeded on until daylight, when we took up a position at a plantation, flanked by a navigable stream, over which there was a bridge which we passed, and placed a piece of cannon to guard the bridge. The Cavalry had unbridled their horses at the plantation, and the Infantry began to cook their breakfast. The enemy charged over the bridge and cut the sentry at the cannon down, and then dashed into the wood. The 19th fell in, some without their coats; great confusion ensued, and they began to

Manuscript of Colonel Jarvis—Born in 1756

give ground. The Cavalry mounted and really forced them to face the enemy. Major Fraser then had some consultation with General Coats, took advantage of a high field of corn, and set off and left the 19th to their fate, and pushed for Charlestown, got a re-inforcement and returned to look after the 19th Regiment, who after we left them General Coats drew up his men in the open field, and waited for the enemy, who came on and were repulsed several times, and at last retreated over the bridge, and sent a flag of truce for leave to bury their dead. Had the Cavalry been with the General, on the retreat of the enemy, we might no doubt have made a glorious day of it, but so it was—they lost all their baggage, but had gained their credit, which in some measure they had tarnished in the morning. I had made up my mind that they would all have been taken prisoners.

A Loyalist and a Patriot in Death Duel on Battlefield

We all marched to Charlestown and in a few days Captain Campbell's Troop were drafted into the South Carolina Regiment, but before this took place, the Regiment had taken a Colonel Haines, who was executed as a traitor. Captain Saunders also with his and Captain Campbell's Troop made an excursion into the country and attacked a body of the enemy at Snipe's Plantation—we approached the place at sunrise in the morning, found the gate leading to the house secured with a large ox chain, and the fences each side made very strong, which it took some time to demolish under a heavy fire from

the enemy. We at last succeeded, and the enemy retreated back into a large rice field, where they were overtaken and very few of them escaped with their lives, and only one man taken prisoner, who was so shamefully mangled that we could not bring him away—one of the enemy, who had nearly gained a wood, discovered that no person was following him but myself, waited for me, and when I had got at a certain distance, levelled his rifle. I expected at least he would have killed my horse. To turn from him was to me certain death. I therefore dashed towards him. He fired and missed me and my horse, and before he could raise his rifle he was a dead man. We returned to our quarters with a few horses which we had taken. We were now stationed at Dorchester, twenty miles from Charlestown, with some Troops of Infantry. Captain Campbell's Troop now became a part of the South Carolina Regiment and we with some Hessian Troops and the 30th Regiment formed a body of Troops for an expedition towards Georgia.

The remaining pages of this remarkable manuscript reveal an astonishing story of conditions in the British Army, and relate many incidents hitherto unknown to American history. The experiences of Colonel Jarvis of Connecticut as a fighter in the King's ranks against his own countrymen, for the sake of his father's principles and his own, is one of the most important documents of the period. Its closing pages will be recorded in another chapter.

SONNET BY HORACE HOLLEY

Covertly in music is a cry
And hidden in the slow fine toll of brush
A stifled eagerness, an untaught rush
Of soul to voice a passion and to die;
Unsought, unbid, an outlawed legacy,
A sudden shriek that stabs the brooding hush
But slinks away at its own audacity

And chokes the fountain's fierce extorted gush.
Toe like a lonely warrior on the field
Who seeks a fair opponent for his lance,
But finds all knights are stooping in a dance
And stilled the ancient sturdy clang of shield.
So as his untamed sword will never tame
Undrawn he bears it from their sluggish shame.



PILOT OF FIRST WHITE MEN TO CROSS AMERICAN
CONTINENT—STATUE OF SACAJAWEA BY
BRUNO LOUIS ZIMM, SCULPTOR



INDIAN GIRL GUIDING EXPLORERS OVER ROCKY
MOUNTAINS—SACAJAWEA AND HER PAPOOSE
BAPTISTE—BY BRUNO LOUIS ZIMM

Pilot of First White Men to Cross the American Continent

Identification

of the Indian Girl who Led
the Lewis and Clark Expedition over
the Rocky Mountains in their Unparalleled Journey
into the Mysteries of the Western World & Recognition of
Sacajawea as the Woman who Guided the Explorers to the New Golden Empire

BY

GRACE RAYMOND HEBARD, PH.D.

LIBRARIAN OF THE UNIVERSITY OF WYOMING
MEMBER OF WYOMING HISTORICAL SOCIETY
MEMBER OF THE WYOMING BAR

THE most hazardous and the most significant journey ever made on the Western Continent—a journey that rivals in daring and exceeds in importance the expeditions of Stanley and Livingstone in the wilds of Africa—a journey that resulted in the greatest real estate transaction ever recorded in history and gave to the world a riches beyond comprehension—was piloted by a woman.

It was an epoch-making journey; a journey that moved the world along; that pushed the boundary of the United States from the Mississippi river to the Pacific; that gave us the breadth of the hemisphere from ocean to ocean; the command of its rivers and harbors; the wealth of its mountains and plains and valleys—a dominion vast and rich enough for the ambition of kings.

When this woman led those first hardy explorers into the wonders of an unknown realm its solitudes were unbroken, except by the war-whoop of the savage and the growl of wild beasts echoing through the forests. The buffalo and wild horse roamed at will over its vast prairies—the stately elk, the timid deer, and the sprightly antelope. The bear and the wolf were monarchs of the forest. Its scenery is the grandest on earth; its natural curiosities the most remarkable in existence, and its river courses the longest in the world.

In honor of this Indian girl, Sacajawea, the only woman who accom-

panied the Lewis and Clark expedition into the northwest an hundred years ago, memorials are being erected. A bill was introduced in the Wyoming Legislature in February, 1907, carrying with it an appropriation of \$500 for the erection of a monument to mark the last resting-place of this woman pilot, the amount asked for purposely corresponding to the amount given Charboneau by Lewis and Clark, at Mandan in 1806. The Legislature of North Dakota has recently, 1907, appropriated the sum of \$15,000.00 for a foundation and pedestal for a Sacajawean statue to be made by Mr. Leonard Crunelle. This is to be erected at Bismark. There is, also, a project on foot in Montana to erect a monument at Three Forks in memory of this woman. Although the governor of Wyoming earnestly recommended to the Legislature in his message an appropriation, the measure failed to become a law, due doubtless to the fact that sentiment for the measure had not been sufficiently aroused and a keen enough interest in the subject awakened. When the measure was presented for passage, it developed that one member of the Legislature had known not only the children of Sacajawea but also their mother.

The grave of Sacajawea has recently been found, and her identity is established by newly discovered evidence herein recorded:

Woman Who Led the Way to the Golden West

TO have one's deeds extolled after a century has passed, when they were hardly recognized when executed, has been the common fate particularly of that class of individuals known as explorers; for the service rendered must be subjected to the test of time and the benefits derived as a result of the exploration must be carefully weighed before applause may be adequately given.

The only woman who accompanied Lewis and Clark across the Continent to the Pacific Coast during the seasons of 1804-6, did not in her life time receive any personal recognition of the services she rendered these explorers during their unparalleled journey to the then unknown great Northwest. But the century that has passed since that event has brought a keener appreciation of her services from those who have taken interest to examine and unravel records of her deeds as a genius of a guide. This woman was a Shoshone Indian who was known by the name of Sacajawea.¹ As she was a wife of a French interpreter, Touissant Charboneau, conventionality might demand that she be known as Mrs. Charboneau; but we prefer to call her more familiarly by her tribal name, because it was her native instincts and intelligence that gave her a place in history rather than that she was the wife of an interpreter. The story of the part that Sacajawea played in this continental expedition is as fascinating as a piece of knighthood fiction; that it is history adds to the charm.

Wyoming was not traversed by these explorers either on the journey to the coast or on the return, yet it claims the distinction of having had this Indian woman guide a resident within its borders for many years and

holds now all that is mortal of this "native born American." The facts leading to the establishment beyond doubt of the identity of the Wyoming woman with that of the woman guide are presented in detail now for the first time. This statement of identity has been met with ridicule, doubt, suspicion, denial. Ridicule has been turned to consideration; doubt to belief; suspicion to admission; denial to acceptance for fact after fact has been presented and corroborated by those of unquestioned integrity.

Sacajawea's life has two periods: that about which we know; that about which nothing can be learned. It is this latter period that has been the stumbling block, "the winter of our discontent." We see her in the vigor of her splendid young womanhood; she disappears as mysteriously as she appeared; when she again is visible it is as the aged Sacajawea, white-haired and well preserved, whose fatal ailment could only be attributed to "old age."

When Lewis and Clark with their party of men, in the fall of 1804, reached the Mandan Indian Villages, not far from the present site of Bismark, North Dakota, they engaged an Indian interpreter who was to accompany them in the spring on their farther western voyage. This French Canadian interpreter, Charboneau, had at that time at least two wives, Sacajawea, the younger, having been sold to him as a slave when she was a child of five years. When he made her his wife she was about fourteen years old. The following year, February 11th, 1805, she gave birth to a son who was destined to occupy a unique position in the expedition which continued its western journey on the seventh of April of that same year. Sacajawea strapped her little papoose, not yet two months old, on her back and practically carried him in this cuddled position, with his view of the surrounding country limited to what he could see from over his mother's shoulder, to the coast and return,

1. Reverend John Roberts, missionary to Shoshone Indians, Wyoming, for twenty-five years, gives the pronunciation as Sāk-ā-jāwe. The a as in far. Last a silent.

Pilot of First White Men to Cross America

a distance of over 5,000 miles. This youthful traveler has been known as "Little Touissant," "Little Charbonneau," but he was called "Baptiste" by Clark and also at various other times when, grown older, he in his turn acted as guide, for he possessed the native instincts and cleverness characteristic of his mother. It is as "Baptiste" that he was known at the time of his death and his children have taken this as their family name.

A century ago the Shoshone Indians made their home around and along the Snake river in Idaho, just west of the Bitter Root Mountains, or, as they are now called, the Rockies. It was in this locality that the Minnetarees, or Blackfeet, swept down and, in mighty battle, slew many of the Shoshones, taking others into captivity. At this time Sacajawea, with a girl friend, was stolen and taken over the mountains toward the East. The girl friend escaped but Sacajawea was forced to the Mandan Village and sold. In journeying west with Lewis and Clark from the Mandans, in the spring of 1805, Sacajawea became more and more conscious that the country over which they were going was that over which she had been taken when in captivity five years previous, and when, after traveling many days, no one of the expedition knew where he was or the true direction to pursue, the party depended entirely upon the instincts and guidance of the Indian woman. The homing bird knew the direction was right, but intelligence had not yet awakened.

At this time Sacajawea was not only helpful as a guide, but also rendered invaluable service on May fourteenth, when her husband, through his clumsiness, turned over the canoe containing all of the papers, instruments, medicine and almost every other article indispensable to the journey, without which it would have been impossible to proceed. Had these properties been lost it would have been necessary to retrace three



PURE TYPE OF THE SHOSHONE GIRL

Virginia Grant, a pupil at the Carlisle Indian School in Pennsylvania, posing for Sculptor Zimm's statue of Sacajawea—The papoose on Sacajawea's back is modelled from the child of William Sitting Bull, son of the Sioux chief

thousand miles in order to replenish the destroyed goods, which requirement in itself would have postponed the journey for at least a year. At the risk of her own life and that of her child, Sacajawea plunged into the stream, righted the boat, rescued the papers and packages that already were floating down the stream. Several days after this when a new river was discovered, Lewis and Clark named it after her. It is now known as Crooked Creek.²

In the summer of 1805 the party camped on the exact spot, the junction of the Jefferson, Madison and Gallatin rivers, where Sacajawea had been captured.³ From this point she

2. Montana.

3. Gass' Journal, page 114 (Hosmer's Edition).

Woman Who Led the Way to the Golden West

recognized familiar landmarks and the path to the West became more and more a matter of memory rather than of instinct. She found for Clark the pass in the mountain through which the party went, on the other side encountering what threatened to be hostile Indians. These Indians, the Shoshones, thought their old enemy, the Blackfeet, had returned to renew their war. Lewis advanced on horseback alone, having discovered an Indian chief with bow and arrows on an elegant horse without saddle. This Indian proved to be a Cameahwait, the chief of the Shoshone tribe. Lewis took his blanket which he had in his knapsack and after holding it up with both hands by two corners, threw it over his head unfolded so to appear as if he were trying to spread it on the ground. This was a signal of peace to signify that it was to serve as a seat for a distinguished guest and is the usual sign of friendliness among Indians of the West. At the same time Lewis kept calling "tabba bone,"⁴ which, as taught to them by Sacajawea, signifies "white man." While doing these things he rolled up his sleeves to show the white skin of his arms, for the many months of sun and weather had tanned both face and hands to the color of an Indian.

A few days after this event Clark, who with Charboneau and Sacajawea had explored another region, made his appearance; upon his approach toward the Indians Sacajawea commenced to dance with joy and excitement and sucked her fingers which was to indicate that the warriors in place of being hostile were of her own tribe. She at once discovered her treasured girl friend whom she embraced with the most "tender affection" and to her infinite delight recognized in the chief her long-lost brother. The Lewis and Clark Journals speak of the most ardent manner in which the feelings of the brother

and sister were expressed. Sacajawea threw her blanket over him and with her head on his shoulder "wept profusely." Here she learned that all of her family had died except two brothers and a son of her eldest sister, "a small boy, who was immediately adopted by her."⁵ This fact, insignificant as it may appear, proves a strong point in establishing Sacajawea's identity. There is no record to show what became of this boy after adoption, whether he went on with the party or whether on its return he went with his adopted mother to the Mandan Villages. No record can be traced of him from that time until recent years when we find him living as the brother of Baptiste and son of Sacajawea, he being known as Bazil.

Sacajawea was home again, not to stay, however, for she never hesitated in her choice to continue with the white man's party rather than to be reunited with her tribe. The expedition at this point purchased horses which were absolutely necessary for the continuance of the journey, as the canoes which had done service to this point now had to be abandoned and the journey made overland until the waters of the Columbia became navigable. Sacajawea discovered a plot which was to drive the horses away that had been purchased from her brother and leave the expedition stranded, with the alternate of having to return by boat or press forward on foot, an impossible task owing to the scarcity of food. Here again she made herself valuable by giving information to Lewis and Clark, even though she had to testify to the treachery of her own brother and his people.

Charboneau was the interpreter, she the guide, though many times she had to come to his rescue. One interesting circumstance will illustrate this important service. There was a con-

4. Lewis and Clark Journals, Volume I, page 379 (Hosmer's Edition).

5. Lewis and Clark Journals, Volume I, page 408 (Hosmer's Edition).

Pilot of First White Men to Cross America

troversy in which two chiefs were implicated over some horses, at a time when the possession of horses meant success or failure. These chiefs, Twisted-Hair and Neeshnepahkecook (Cut Nose), were of the Chopunn tribe. One of Lewis and Clark's men took the wording of the trial in English and turned the English into French for Charboneau, who translated this French into Hidatsa for Sacajawea, while Sacajawea gave this Hidatsa in Shoshone to the Shoshone prisoner, who in turn adapted this Shoshone to Chopunnish for the contesting Indian chiefs. A recital of all of the service that this Indian woman rendered to the expedition would require a daily extract from the Lewis and Clark Journals, for it was as constant as it was unselfish.

How Lewis and Clark who selected all of the men who were to accompany them for varied and special qualifications which would best and most miscellaneously serve the expedition, failed to include some one of the medical profession or one skilled in surgical science is a matter quite beyond comprehension. Along these lines, however, Sacajawea added to her value, for her native and secret knowledge of medicinal herbs and plants and their curative properties was of extreme worth in time of sickness. Again it is difficult to imagine when starvation seemed to be the only outcome what would have been the result if she had not concocted messes made from seeds and plants and had not known of the riches stored away in the prairie dog holes where were found artichokes as valuable as potatoes. The coast was finally reached December 7, 1805, where the party made winter quarters at Clatsop, four thousand, one hundred and thirty-five miles from St. Louis, the starting point.

March, 1806, found the party ready to retrace the many weary miles. The entire party that left Mandan reached that point in August of this same year. At this point we must



GREAT - GREAT - GRANDDAUGHTER OF SACAJAWEA - Indian Woman, Eunice Bazil, photographed in her native costume on the Shoshone Reservation for Dr. Hebard's identification of the Lost Pilot of the Lewis and Clark Expedition into the Unknown Northwestern American Frontier

abandon the exploring party and confine ourselves to the movements of the actors who are most vitally connected with the history of our Indian Princess, for such a title she could have rightfully claimed through her royal blood. Charboneau received from Lewis and Clark for his services the sum of \$500 and a few odd cents. There is no record to show that Sacajawea received any compensation by gift or word. It is true we find the following in the journal: "This man (Charboneau) has been very service-

Woman Who Led the Way to the Golden West

able to us, and his wife particularly useful among the Shoshones. Indeed she has borne with a patience truly admirable the fatigues of so long a route incumbered with the charge of an infant, who is even now only nineteen months old. She was very observant. She had a good memory, remembering locations not seen since her childhood. In trouble she was full of resources, plucky and determined. With her helpless infant she rode with the men, guiding us unerringly through mountain passes and lonely places. Intelligent, cheerful, resourceful, tireless, faithful, she inspired us all."

The finding of letters written a hundred years ago shows that Sacajawea was more keenly appreciated than we had been led to believe. This evidence was first made public by an article in the *Century Magazine*,⁶ the letter having been written August 20, 1806, by Clark on his voyage down the river after leaving Mandan.

"CHARBONO:⁷

You have been a long time with me and have conducted yourself in such a manner as to gain my friendship. Your woman who accompanied you that long, dangerous and fatiguing route to the Pacific Ocean and back deserved a greater reward for her attention and services on the route than we had in our power to give her at the Mandans."

No further attention was paid to this woman, not even in the accounts that have been published by those who made the journey, until the time of the St. Louis Fair, called the Louisiana Purchase Exposition, in 1904; and later at the Lewis and Clark Exposition in 1905, at Portland, Oregon. Mrs. Eva Emery Dye attracted attention to this pilot of the West in her book, "The Conquest," in which she has extolled not unduly the devotion of the little woman to the cause of Lewis and Clark on their marvelous trip. Mr. Bruno Louis Zimm, the New York sculptor, in his preparation for the modelling of a statue for the St. Louis Fair spent a year in studying the literature and ethnology involved in this subject. When the time came for him to procure a model typical of the woman of the Shoshone tribe he was instructed to correspond with Reverend John Roberts of the Shoshone Reservation in Wyoming where he had preached and worked as a missionary for a quarter of a century. This reservation is located in the center of the state, having been the home of Indians for many generations. Mr. Roberts directed Mr. Zimm's attention to one of the young Shoshone women, Virginia Grant, who was at that time and is at present a student at the Carlisle Indian School. She is pronounced to be decidedly typical of this tribe.

6. Volume LXVIII, page 876.

7. Captain Clark not only spelled phonetically, but evidently early anticipated the spelling reform movement.

DESCENDANTS OF THE INDIAN PILOT—The four in the back row from left to right are Maggie Meyers, daughter of Baptiste, the son of Sacajawea—Charlie Meyers, son of Maggie Meyers—Charlie Meyers' wife who is not a blood relative of Sacajawea—George Bazil (We-to-gan), son of Baptiste—The front row from left to right are Nannie Bazil, daughter of George Bazil—Fannie Meyers, daughter of Charles Meyers—Willie Bazil, son of George Bazil—Little Bessie and Oro Meyers, the daughter and young son of Charles Meyers



Pilot of First White Men to Cross America

In the correspondence incident to obtaining the desired information Mr Roberts in a personal interview with the author of this article imparted long-sought information which carries with it substantial evidence of its authenticity. After Mr. Roberts had been informed that the purpose of this photograph of Virginia Grant was to assist in modelling a statue of the woman who gave Lewis and Clark guidance across the mountains it freshened his memory to the extent that he remembered burying a very old Indian woman during the first years in his field of labor in Wyoming. Upon examination of his parish records, which he had carefully kept since assuming his duties with the Shoshone Indians, he found this notation under date of 1884, April 9, "Bazil's mother, Shoshone, one hundred years, residence Shoshone Agency, cause of death, old age, place of burial, Burial Ground Shoshone Agency." Mr. Roberts on January 8, 1906, while attending a funeral of one of Chief Washakie's grandsons, heard a great wailing as is the Shoshone custom, for they mourn with a great and very sore lamentation, and observed one of Sacajawea's granddaughters standing over her grave "giving away to her grief in great wailing." This cemetery or burial ground is a forty-acre tract fenced in with a very strong and lasting fence of cedar posts and twisted barbed wire on either side of the posts and twisted together between posts. Only a slight slab marks Sacajawea's grave. The proper marking of this grave should have immediate attention while he who buried her can identify the ex-

act locality. This woman was known in the Shoshone valley as Sacajawea and had two sons called Bazil and Baptiste, both of whom were personally known by Reverend Roberts. Old Indians now living testified to him that in her earlier life Sacajawea was "very nice looking;" short of stature, spare of figure, very intelligent and quick in her movements. Reverend Roberts stated that Sacajawea in 1883 was wonderfully active and intelligent considering her great age. She walked alone and was bright to the last. She had no sickness but was found dead one morning April 9, 1884, on her "shake-down" of blankets and quilts in her tepee. In the afternoon of the same day she received a Christian burial. This woman was illiterate, but spoke French as well as did her two sons.

Although Shoshones claim nephews as sons and will not admit any adoption, yet, for thirty-four years at least there had been a rumor, amounting to a statement of facts, that Bazil was not Sacajawea's own son but was a nephew and had been adopted. This is a crucial point in the case because it was a puzzling fact that this son Bazil should be older than Baptiste (Bat-tees as pronounced by the Indian) who was the child carried on the



GREAT - GREAT - GRANDCHILDREN OF SACAJAWEA—These photographs were recently taken on the Shoshone Reservation during Dr. Hebard's investigations and they picture the descendants of the Indian Guide in native life—The older Indian woman on the left is Mrs. Charles Meyers and to the right is Eunice Bazil—The three little ones on the left are Fannie, Bessie and Oro Meyers—The boy and girl at the right are Willie and Nannie Bazil, children of George Bazil

Woman Who Led the Way to the Golden West

mother's back during the journey to the coast, Baptiste being then her only son, hence the oldest. We must refer again to the Lewis and Clark Journals, page 408, Volume I, to that single line—"a son of her eldest sister, a small boy, who was immediately adopted by her." Had the child been a baby, or papoose he would not have been a "small boy." These few words furnish convincing explanation why the *older* son was not the one Sacajawea took with her and why there was a family tradition that Bazil was adopted. Bazil and Baptiste both told Mr. Roberts that Baptiste was the child that was carried to the coast. This isolated piece of evidence about the adoption and the child so adopted being older than her own child is not one generally remembered or noticed. As it appears in the Journal it has no significance and that child is never mentioned again so far as can be ascertained.

Again, the name of "Baptiste" has been a stumbling block, because the little papoose was known in history for a century as "Little Touissant," or "Touissant Charboneau" or "Little Charboneau," and so that when we introduce into the romantic history an aged man with an entirely new and foreign name there is certainly a demand for an explanation and a reconciliation of facts. If we will go back to the spring of 1805, Sunday, April 7, when Lewis and Clark engaged their additional men at the Mandan Village we find the name Baptiste Lapage.⁸ This man at that time was living at the locality where Charboneau and Sacajawea made their home or headquarters. As they were friends and companions it is not improbable or unlikely that his first name was given the first child of the French Canadian interpreter. There is no mention of this child's name in all of the journals and accounts that have been printed about the journey. But in going over the private papers

8. Lewis and Clark Journals, Volume I, page 190.

of Captain Clark the letter before mentioned contains more valuable information than that before cited. A portion reads as follows:

"As to your little son (my boy Pomp) you well know my fondness for him and my anxiety to take and raise him as my own child. I once more tell you if you will bring your son *Baptist*, I will educate him, etc." . . . "with anxious expectations of seeing my little dancing boy Baptist, I remain your friend.

WILLIAM CLARK."

This letter was written in 1806 and never was known to the public until 1904, yet for thirty-five years at the least prior to the latter date. Sacajawea's own son was known as Baptiste. Incredibility cannot attach to this point in the evidence, for the facts are substantiated by a hundred living witnesses as to the name by which the son had been called by his mother, for thirty or thirty-five years. Documentary evidence shows further that Captain Clark was true to his promise and had little Touissant Charboneau and Sacajawea come to St. Louis where the boy was placed in a Catholic school, the teaching being in French, the language of his father. We find in Captain Clark's account as Indian Commissioner, to which office he was appointed by the president after his return from the West, items under date of 1820, covering expenses for school books, shoes and other things for a boy. This account appears in the name of Touissant Charboneau, doubtless our interpreter rather than the son. His boy was born in 1805, hence was fifteen years old at this period of his education. Baptiste and Bazil, we must remember, spoke Shoshone, French and English.

The descendants of Bazil scorn the idea of having any French blood in them and claim only the blue blood of the American Indian and there is strong evidence that they are right in their assertion. There is nothing to show that Sacajawea's sister, the mother of Bazil, ever saw a man other than the Indian. The descendants of Baptiste look like mixed blood and

Pilot of First White Men to Cross America



THE RESTING PLACE OF THE BRAVE INDIAN GIRL PILOT

Photograph taken at the grave of Sacajawea in the Shoshone Indian Agency cemetery at Wind River, Wyoming, for Dr Hebard's investigations—The older girl is Eunice Bazil, great-granddaughter of Bazil, and she is standing at the head of the grave which is marked only by a short stick and low mound—The smaller girl is Bessie Meyers, great-great-granddaughter of Sacajawea and she stands at foot of grave

act as such, associating more with whites than Indians usually do. They have acted as guides in earlier days and as United States police later, intermixing with whites and Mexicans. A son of Baptiste told Mr. Roberts that his father often told him that his grandmother had carried his father (Baptiste) when a babe on her back at the time she showed the way to "The first Washington" across the Crow Indian Country to the "Big Water toward the Setting Sun;" that Baptiste's father (Charboneau) died "long ago" near the site of the present White Rocks Ute-Agency, Utah, and that he had a lot of papers that were burnt at his funeral.

The name Sacajawea, according to Reverend Roberts, who has made a careful study of the Shoshone language for the quarter of a century he has worked with this tribe, is derived from *Sac*—canoe or boat or raft; *a*—the, *jawe*—launcher. It is a pure Shoshone name. Had the word been spelt *sac-a-dza-we-a* (pronunciation almost identical with the former word), it would have meant, if a Shoshone word, *Sac*, which one? *a*, the, *dza*, good, *wea*, gap, or mountain, or pass, "which one is the good pass?" The oldest Shoshone and also Sacajawea's descendants state that her name was "Wadze-wipe" (Lost Woman), Bah-ribo, (Water-White

Woman Who Led the Way to the Golden West

Man) and Boo-e-nive, (Grass Maiden). Most Shoshones have several names. If it be true that the name Sacajawea is not Shoshone, and should be spelled Sakakawea, or "Bird Woman," as is stated by some who have made a study of Indian languages, and affirm the word is Hidatsa, this would account for the fact that she was not known by that name among these Shoshones.

Perhaps even more valuable than all of this information is the evidence submitted by Mr. James I. Patten, a resident of Wyoming, who in a personal interview told a similar narrative. Mr. Patten came to Wyoming in 1871 when the one railroad in the then Territory of Wyoming only reached to Laramie, a point about sixty miles west of the Eastern State line. From this point he went to the Shoshone Valley by prairie schooner and by broncho before there was even a wagon road, only a trail serving as a guide. Mr. Patten had been sent into this locality by the Episcopalian denomination to teach and to convert the Indians to Christianity. His duty was to prepare Indians and others for baptism, which ritual was performed by the Bishop at stated intervals. He continued in this work until 1880.

He first saw Sacajawea in the fall of 1871. She was then very old. She was pointed out to him as the squaw who had accompanied Lewis and Clark. Mr. Patten had read the Journals of Lewis and Clark before coming to this valley and at that time, 1871, was wholly convinced from the information he gleaned that the Sacajawea of Wyoming was the Sacajawea of the Lewis and Clark expedition. Dr. Irwin, whose place Reverend Roberts commenced to occupy in 1883, talked to Mr. Patten about the matter and said that he had collected from her and from her son a good deal of material about this journey which he intended to publish; that, after carefully reading Lewis and Clark's Journals he was convinced that the two Sacajawears were

one and the same. Dr. Irwin has been dead many years and it is feared his notes have been destroyed, although an active search is being made for them. It is difficult to tell the exact age of Indians, but Basil and Baptiste were old men when first seen by Mr. Patten. He knew them both and talked with them about their mother and her trip. Both of these men spoke the three languages, Shoshone, French and English, their degree of proficiency being in the order named. Basil, when he found Mr. Patten was learning their dialect, took a great deal of interest in telling him of his mother and her service as a guide to Lewis and Clark. It is difficult to get any information from a Shoshone Indian when he is conscious one is trying to extract facts. They cannot be drawn out of him; he must volunteer the information. Once, however, get an Indian interested in the subject at hand and then unconsciously he will impart the desired information. Aged Indians are very superstitious and exceedingly secretive, being reluctant to converse with white people on certain topics, more particularly if they refer to their family or tribal movements. Sacajawea at this time conversed with few. She lived in a tepee by herself, but her two sons looked after her very carefully and tenderly, the special attention coming from Basil who apparently was slightly the older, although the two men seemed to be so near of an age that it was impossible to say which one was the older. Basil was the owner of an Indian dwelling situated near the Agency. The most marked characteristic of the Shoshone Indian is that his tribal ties are even stronger than his family ties. A Shoshone woman will leave her husband and even small children to return to her tribe. This powerful instinct or trait is unquestionably the one that brought Sacajawea with her two sons down from Mandan to the new region selected by her tribe.

Pilot of First White Men to Cross America

In 1871, when this tribe was preparing to go forth on its annual hunt, Bazil brought his mother up near the government house and pitched her tepee there, saying to Mr. Patten: "This old aged woman is my mother and I want to leave her at the Agency when we are on our hunt." At this time he made a statement as to her age and while he did not exactly know what it was he thought she must be nearly one hundred years old; he stated that she went to the place of "much water" (the ocean) for the "Great Washington" (the government is always Washington to these Indians) and that the men she went with were the first white men who ever crossed the country. He did not then mention the names of Lewis and Clark until they were spoken by Dr. Irwin and Mr. Patten. Indians do not remember exact dates or names readily, although events are accurately reproduced. Sacajawea stated to both Dr. Irwin and Mr. Patten that she had made the voyage and she talked of the "Big Waters beyond the Shining (snowy) Mountains." Wito-gan, the son of old Baptiste, told Mr. Patten that his father had often told him that his mother acted as a pilot to "A-va-je-me-ar" (the first Washington).

Once she came to the Agency when Mr. Patten was there, at the time of the drawing of rations, to draw hers; he told Bazil that she was too old to carry these provisions. "Yes," said Bazil, "pretty old; pretty old." Bazil was particularly devoted to her and looked after her with great care and consideration. This attention is usual among the Shoshones who take good care of their old people. Baptiste was always attentive but had no charge of her as she always had her tepee nearer the house of Bazil. "Bazil's mother,"—she was commonly known by this name—always wore the Indian costume with blankets and moccasins and her hair down her back. While Bazil and Baptiste wore the Indian costume, they always wore a hat and negligee

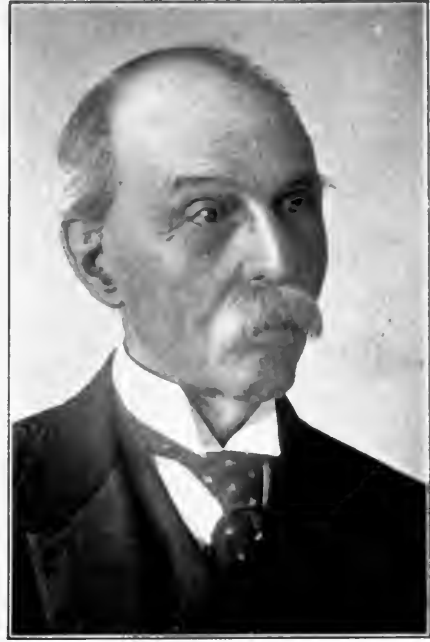

SURVIVAL OF AN EARLY EXPEDITION TO WYOMING—Captain William Clark Kennerly of St. Louis, Missouri, who went to Wyoming in 1842 and who conversed with Sacajawea's son at Fort Laramie—Captain Clark is named after his distinguished uncle of the Lewis and Clark Expedition of 1806—He testifies that Baptiste recognized Jefferson Clark, the son of Captain Clark, from his memory of the features of his father, the explorer

shirt in addition to the blanket. Their children wear the native costume. Thirty-six years ago Sacajawea looked as if she might have been a pretty plump, good-looking woman of medium size. The true Shoshone type is one of robustness and short in stature. Mr. Patten not only knew Sacajawea and her sons, but knew the grandchildren and prepared them for baptism when they embraced our religion, in as far as they could understand it. When the Bishop (George Maxwell Randall) baptized them they were given Christian names, the children taking their father's names as their last name. Bazil and Baptiste and their descendants seemed to feel it a great honor that their mother had been allowed to accompany the "Great Father," which deed gave to them an

Woman Who Led the Way to the Golden West

inheritance that was akin to an aristocracy. Mr. Patten never heard of Sacajawea having any husband other than Charboneau, and she was known also by the name of "Lost Woman." Chief Washakie. (Was-a-kie, the lightning striker—he kills him running) who made the treaty at Bridger in 1868 with our government for the reservation in the center of Wyoming, in a conversation with Mr. Patten, mentioned Sacajawea as the woman who accompanied the white people who went to the Great Water.

In order to obtain favor from the Indians they knew they were to encounter, Lewis and Clark carried with them many bright trinkets and gorgeous presents. These were given to the ordinary Indians, but to the chiefs they presented medals. These were of three grades. To the chief of chiefs they gave a medal with the likeness of the president of the United States (Jefferson) on one face; to chiefs of a secondary order a medal decorated with some kind of a domestic animal; and to the third chiefs a medal with the imprint of a farmer sowing grain. The chiefs wore these medals suspended on a cord around their necks. The brothers of Sacajawea each received one of these medals.⁹ On state occasions Basil wore a medal suspended from his neck which he said his father (Sacajawea's husband) had given him. Charboneau said Lewis and Clark had given the medal to him. Reverend Roberts and Mr. Patten have both seen this medal, the former saying that Basil was buried with this silver medal or scarf protector, while the latter affirming it was about as big as a silver dollar.

To strengthen the foregoing statements there has been added the verbal information from Mr. Richard A. Morse, who was a government blacksmith on the reservation from 1882 to 1890 and had often seen Sacajawea. When he first saw her she was an old,

old woman, with white hair and no teeth, but even with this defect was nice-looking. For a woman of her age she was remarkably straight. She was short and heavy and was a "regular, genuine Shoshone woman." People in 1882 knew of her trip and talked to him about her and it. He had seen her any number of times picking sagebrush and packing it on her back to her tepee to burn. The sons were very strong in their family relations and were short, straight and stout.

In a conversation with Mr. H. E. Wadsworth, the United States Indian agent at Shoshone or Wind river, he stated that Sacajawea had died before he entered upon his duties at this reservation over twenty years ago, but she had repeatedly been spoken of by those who had known her as one under-sized, but very straight. He did not know her sons, but knew her grandchildren and great-grandchildren and great-great-grandchildren, all of whom were or had been at the agency school, and one at least at the Carlisle Indian School. The grave in which lies all that is mortal of Sacajawea is situated about sixteen miles northwest of Landar (the county seat of Fremont County), and two miles west of the Shoshone Indian Agency. The location of the cemetery is bleak, situated on a hill without surrounding trees or grass, in the center of a former hunting-ground. Mr. Wadsworth corroborated the statement that the Indian woman was known as *Wad-se-wip* and that Sacajawea is derived from two pure Shoshone words, "boat" and "to push."

Mr. Lahoe, the government interpreter for the Shoshone Reservation, whose mother is a Shoshone Indian, added interesting information to the effect that he had personally known both Basil and Baptiste and knew where they were buried, having helped in the burial of Basil. Baptiste is buried up in the mountains, his body having been taken there by a few Indians and dropped down between two

⁹ Lewis and Clark Journals, Volume I, page 409.

Pilot of First White Men to Cross America

crag, about forty feet deep. After the body had been let down by a rope, a few rocks were thrown upon him, one striking his head and crushing his brain. Bazil was also buried after the Indian custom. Wrapped in a sheet and blanket he was taken by a few Indians up to Mill Creek and placed in a new gulch which was dug into the bank and allowed to cave down and cover him. At the time he was buried he had a silver medal upon his neck. Bazil was a powerful man, a warrior and one of the bravest men among Indians. He was also a hunter and trapper, Indian Doctor and Medicine Man. Baptiste was a guide, not as civilized as Bazil, having all of the Indian beliefs which Bazil did not have. Bazil's oldest son was known as Eddeto-que (Ed.). His next child is Nibe-chee (Ellen), followed by Ando, known as (Andrew Bazil), and Maggie. The last three are living and on the reservation. Maggie Bazil has nine children: Charles, Nettie, Kittie, Willie, Ellen, Leddie, Freddie, Roy and Lawrence. (This generation makes no claim to Indian names.) Baptiste had three wives who were sisters; his children are: Barbara, Antyne, Jim and George Bazil (We-to-gan). Barbara married a man by the name of Meyer, whose son, Charles Meyer, at one time attended the Carlisle School and now acts in the capacity of a herder. This son has seen the medal around his grand-uncle's neck and was present at his burial. He has three children, all of whom appear in the picture. George Bazil Baptiste (We-to-gan) has two children, Willie and Annie or Nannie. (One cannot help deploring the disappearance of the liquid Indian names which are fast being supplanted by most ordinary ones).

Having proved Sacajawea's identity, established beyond a question of a doubt her home and the location of her grave, explained the seeming discrepancy in the age of her children, and fitted the name of Baptiste to the little papoose journeying on his moth-

er's back, the next step is to substantiate these statements by showing that, prior to 1871, the earliest date which we have thus far fixed as the home of Sacajawea in Wyoming, the son of Charboneau was seen and known as his son in the neighborhood of the present Shoshone Indian Reservation.

In 1811, Brackinridge states that Sacajawea and Charboneau were seen on the Missouri river. Maximilian's writings make frequent mention of "Charboneau" working up and down the Missouri. We also find evidence that he served as an interpreter for Sublette and Campbell who explored and traded in Wyoming 1826-32. In 1838, last mention is made of him by Larpenteur¹⁰ as "old Mr. Charboneau." Sacajawea was many years younger than her husband and it would be natural if she followed her sons after his death. It is positively known that Sacajawea's Baptiste was with James Bridger at Fort Bridger (where the now abandoned fort was situated in the southwest corner of Wyoming), in 1832, acting as a guide and mountain explorer. He is mentioned in Wyeth's Journal, in Bonneville, 1832-5, and in Fremont 1842-3, both of whom were in Wyoming at the dates indicated. The most trustworthy information, however, that Baptiste was in Wyoming and on the Overland Trail which passed just south of the Shoshone Reservation, is given by Captain William Clark Kennerly, at present a resident of St. Louis. Mr. Kennerly imparts the following authentic information in a letter of December, 1906. In 1842, Sir William Drummond Stewart organized a party to hunt buffalo and other game; among others engaged to assist was one "Baptiste Charboneau" who acted in the capacity of a driver of one of the carts. Mr. Kennerly, named after his uncle by marriage, Captain William Clark of the Lewis and Clark expedition, was one of this party. Cap-

10. Wheeler, O. D. The Lewis and Clark Trail, Volume I, page 130-4.



THE WOMAN WHO LED THE WAY TO THE GOLDEN EMPIRE
OF WESTERN AMERICA—STATUE TO SACAJAWEA
AND BAPTISTE ERECTED BY THE WOMEN OF
OREGON AT PORTLAND — MISS
ALICE COOPER, SCULPTOR

Pilot of First White Men to Cross America

tain Clark's son, Jefferson Kennerly Clark, a cousin of Captain Kennerly, was also one of this hunting party. This expedition, which consisted of eighty members, including guides, drivers and hunters, came into Wyoming as far north as Fort Laramie, which was on the old Overland Trail, and where there were fifty or sixty lodges of the Sioux Indians. This Baptiste, when he saw young Clark, at once "welcomed him as the son of his old guardian." Some of the Sioux chiefs immediately recognized Jefferson Clark from his strong resemblance to his father who became known to them on the Pacific Expedition, and called him at once "son of redheaded father," that being the name by which Clark was known to the Sioux Indians, the color of the hair of father and son being identical and of a striking hue. St. Louis was always called by these Indians "Redhair's town." Captain Kennerly is the only one of this party now living. In this Indian, Baptiste Charboneau, we find one who not only bears the name of Sacajawea's husband, but who also has a given name that, until 1904, was never known to have been associated with that of Charboneau. Further, if the Sioux Indians in their hunts came as far south as Fort Laramie it would be possible for Sacajawea also to have come that distance to be with her son, who was familiar with the land around this locality.

An analytical examination of the pictures, paintings and statuary created to represent Sacajawea has developed the fact that there existed an exceeding diversified interpretation of the character of this Indian woman. If we examine the painting by Mr. Paxson¹¹ we measure her as tall, rawboned and angular. Miss Alice Cooper's noble and graceful statue at Portland, erected by the women of Oregon at a cost of \$7,000, represents an ideal type of an Indian woman.

11. Wheeler, O. D., *The Trail of Lewis and Clark*, Volume I, page 126.

The statue made by Mr. Zimm which stood at the end of one of the esplanades, between the Liberal Arts and Manufacturers' buildings at the St. Louis Fair not only portrayed the true type of a Shoshone woman, but also mirrors our heroine's nature. Accordingly with the assistance of this sculptor and the writings of Lewis and Clark we are able to grasp and realize to a great degree what was the character thus delineated and why our guide is entitled to be classed as noble. Lewis wrote on July 28, 1805: "She does not, however, show any distress at these recollections, nor any joy at the prospect of being restored to her country; for she seems to possess the folly or the philosophy of not suffering her feelings to extend beyond the anxiety of having plenty to eat and a few trinkets to wear." This mood of Sacajawea, that most familiar to the explorers, seems to be a striking characteristic of the Indian. That they are capable of real feeling, those who have studied the subject the most emphatically affirm. This manifested itself in Sacajawea's case to such a degree that it astonished Lewis and Clark when she met her brother, the Shoshone chief, on August 17, 1805. These exhibitions of real feelings are so seldom that they challenge the average observer to represent them as a common trait of the Indian. The characteristic of the Indian women seems to have been their stoical obedience to their condition of servitude. This quality was not foreign to Sacajawea's people. We remember the calm resignation of the Shoshone women when Lewis surprised them when he came through the pass approaching their valley.¹² No cry nor sound passed their lips; they sat with bowed heads expecting death and waited for a fatal blow. That Sacajawea was not devoid of this sentiment the records of the journals give ample illustrations. This stoicism

12. Lewis and Clark Journals, Volume I, page 387.

Woman Who Led the Way to the Golden West

was the foundation of Mr. Zimm's conception of the heroine and explained to him her fortitude, her calm endurance and patient suffering. There was a certain amount of natural and legitimate curiosity in her nature, however, as borne witness to by Captain Clark after she had pleaded to be allowed to accompany them from their inland camp to the ocean's beach. "The poor woman stated very earnestly that she had traveled a great way with us to see the great water, yet she had never been down to the coast and now that this monstrous fish was also to be seen, it seemed hard she should not be permitted to see neither the ocean nor whale, so reasonable a request could not be denied." This, then, is what we see in Mr. Zimm's statue: "a stoical, patient figure, on its face an expression of searching curiosity." The sculptor obtained a pure type for his model, Virginia Grant, who, not particularly anxious after her contact with civilized life to part her hair and have it fall down her back, brought the pompadour down reluctantly. Her dress is patterned after the Minnetance by whom Sacajawea was so long kept in captivity. The papoose on Sacajawea's back is modelled after the child of William Sitting Bull, son of the great Sioux chief.

Thus we have Sacajawea represented in her true character, the patient, plodding type looking ever westward toward the goal of the expedition.

To recapitulate in the briefest possible terms commensurate with clearness, the preponderance of evidence establishes the fact that the Sacajawea who lived on the Wind river, or Shoshone Reservation in Wyoming is the Indian woman Sacajawea who acted in the capacity of pilot, guide and interpreter to Lewis and Clark in 1805-6.

In the years, even the generations, that have become history since the performance of these services for Lewis and Clark, no one has offered herself in evidence as this "Lost Wo-

man;" there is no record of any person endeavoring on the behalf of Sacajawea to advance the claim of any other Indian woman for this enviable position; repeated and continual efforts have been made by a host of interested and enthusiastic investigators to obtain a clew which would ultimately lead to this identity and yet no one, impostor or otherwise, has made a claim for this recognition, excepting in the case at hand of this heroine of the Shoshone Valley.

If *our* Sacajawea is *the* Sacajawea, why did she fail to herald the truth which her third and fourth generations now relate with pride? Was it a matter over which an Indian would be anxious to proclaim that she was instrumental in leading into the Indians' territory the first white men who, with their civilization, eventually would occupy and possess the hunting grounds and force the red man to other fields? Even if the act were one of extreme bravery and worthy of praise, would not the perpetrator for this reason be silent before her tribe, only dreaming of the past, occasionally reciting the incidents of the deed to her children and thus by word of mouth transmitting a mighty inheritance to her children's children and only upon interrogation imparting the facts to the white man? Sacajawea *never* volunteered information on the subject as all of the evidence distinctly exhibits. Again, the white man would be equally tardy in admitting that it was only through the efforts of a red woman that the expedition was a possibility. Thus viewed from either side we have good and sufficient reason for silence.

Captain Clark, with his erratic regard for phonetic spelling wrote the name Sacajawea and Sarcargarwea, never Sakagawea or Sakakawea. The author of the "Conquest" at the time of the unveiling of the statue at Portland, in 1906, learned from a personal interview with Judge W. R. Shannon of California, whose father was one of the Lewis and Clark party,

Pilot of First White Men to Cross America

that the Wyoming pronunciation of the word agrees exactly with that of the Sacajawea his father many, many times had pronounced when telling about the trip. He strongly and immovably asserted that the name should be *SacaJAWea*, and was so persistent in his statements, which certainly bore authenticity, that this pronunciation was finally accepted by the Portland people.

The finding of the letter from Captain Clark to Charboneau written almost immediately after their separation, a century after it was written, furnishes the strongest link in the chain of evidence. Here for the first time we can associate the name of Sacajawea's son of the reservation with that of the child carried on her back to the coast; again, this "Baptiste" was in St. Louis as Sacajawea's son in 1820; this same Baptiste was seen and known as Charboneau's son as Baptiste in Wyoming where he was with James Bridger and acting as a guide and explorer. Wyeth and Bonnevile in 1832-5, and Fremont in 1842-3 corroborates this statement.

The strongest direct testimony, however, is that given by Captain Kennerly who saw "Baptiste Charboneau" at Fort Laramie in 1842.¹³

The recognition at once of Captain Kennerly's cousin by "Baptiste Charboneau" as being the son of his guardian, Captain Clark, must be carefully considered; the Sioux chiefs greeting young Clark as the son of their "Red Hair Chief" must not go unnoticed; the fact that these Indians had been hundreds of miles from Fort Laramie when they encountered Lewis and Clark must be accepted. If these Indians could have wandered so far South on their hunts it would not have made it impossible for Sacajawea to have also come that distance, either then, before, or afterwards;

and further, the fact that Sacajawea, being much younger than her husband, would after his death desire to make her home with her son. This all must be taken into consideration and form a bulwark of evidence which it is difficult to successfully assault.

That the newly discovered Sacajawea had an older son than Baptiste, this in place of refuting the claim to be established has only strengthened the case in controversy.

The statements presented by Dr. Irwin who knew Sacajawea on the reservation in the sixties and *at that time* believed the two Sacajawegas to be the same, is strong testimony, for not only was Dr. Irwin a man of education, but one of unquestioned integrity. This was at a period when the expedition did not particularly engage the attention of the public; it was too long from the time of the journey and too far from the period when interest had become renewed (incident to the expositions to celebrate the expedition). Dr. Irwin was isolated from the outside world and drew these conclusions unaided except from the reading of the Lewis and Clark Journals before coming to Wyoming and the direct evidence obtained from Sacajawea by him. Mr. Patten not only corroborates this statement, which was also given by Reverend Roberts, but he himself had come to this same conclusion in 1872.

These three men, Irwin, Patten and Roberts, must, through the important positions they occupied, be classed as intelligent, accurate, trustworthy and capable of arriving at results without jumping at hasty conclusions, of which an ordinary traveler might be accused. They all three lived among these Shoshones for years, working with them in the endeavor for their betterment spiritually, mentally and domestically.

The last arguments, not the most conclusive however, are that there are scores of inhabitants of Wyoming, living or having lived in this beautiful and fertile valley¹⁴ who have not only

13. Fort Laramie is on the old Overland Trail situated a few days' travel east of the Shoshone Valley where this tribe of Indians then as now lived.

Woman Who Led the Way to the Golden West

heard Sacajawea tell of her mountain, plain and coast adventures, but her sons have recited the story as told by the mother, that the children's children have this history sacredly stored in their hearts and that the fourth and fifth generations of our patient, stoic, unselfish and unerring guide are learning of this journey which, to them as to those who have read of it, seems as yet a myth, an act perpetrated on "the happy hunting grounds."

14. This is the reservation which in part was thrown open to settlement in 1906. Many of the Indians opposed this sale to the government and as a consequence there has been engendered a bad feeling between those who favored the segregation and those who opposed the movement. In January, 1907, some of these disgruntled Indians lay in ambush to murder Reverend Roberts on his return from a county funeral. His long acquaintance with the movements of the Indians prevented a fatal disaster. After observing their actions he changed his direction and reached the flats where the Indians did not dare pursue.

THE NOBLER RACE—BY FRANK P. FOSTER, JR.

HAIL to the honor of woman,
Sisters and mothers and wives,
Hail! to the name of the nobler race
That leads the nobler lives.

Out in the open we battle,
Free, where the sun shines clear.
We do not watch and wait at home,
Haunted with nameless fear.

Where is there faith like a woman's—
Purer than beaten gold—
Or courage to enter the shadow of death,
Are there men with hearts so bold ?

She cannot fight in the open,
Free, where the sun shines clear,
She wrestles with foes far greater than ours,
She conquers the awful fear.

We have read of the courage of heroes
Who follow at Duty's call,
Who face the fight with power and might,
Soldiers and sailors and all—

We honor the man of strenuous life,
We place him above the rest,
But what of the woman of womanly ways,
Whose fortitude is the best?

Then take this word to our women,
Sisters and mothers and wives,
Take this word to the nobler race,
That leads the nobler lives.

Men, when you enter the battle,
Free, where the sun shines clear,
Pray God for a woman's courage
To suffer and conquer fear.

Life on an American Trading Vessel

Adventures

on the High Seas in the

First Days of American Commerce &

When Privateering was a Prosperous Occupation

and Daring Men Chose the Hazards of Seaman'ship & Journal

of Samuel Hoyt, an Early American Sea Captain, Born in 1744 & Transcribed

BY

JULIUS WALTER PEASE

NOW IN HIS NINETY-THIRD YEAR AND A GRANDSON OF CAPTAIN SAMUEL HOYT

THESE adventures of an early American sea-captain relate experiences in the first days of the American Republic that are fully as interesting as the pages of the ancient journal which told of life on the high seas off the American coast in the pre-revolutionary days, fugitive wanderings along the desolate Atlantic shore, adrift on the ocean in a storm, and the seafarer's home-coming after many tragedies at sea.

After fully recovering from his exposures and terrible sufferings, Captain Samuel Hoyt again set sail. He here relates this voyage and his subsequent experiences in the days closely preceding, during and following the War for Independence.

The adventures of Captain Samuel Hoyt as related in his own journal and published in these pages, created wide interest, not only as an historical contribution showing the indomitable courage of the pioneer Americans and their hardships and sufferings, but as a narrative of the sea. An eminent reviewer pronounced it "a true sea story more fascinating than fiction." This new chapter of the ancient manuscript has been transcribed and is here recorded from the original now in possession of Mr. Henry Stone of Madison, Connecticut, who is the son of Stephen Stone, the stepson of the rugged seaman who inscribed the narrative, and is now in his ninety-first year. The transcription is through

the courtesy of Mr. Julius Walter Pease, of New Britain, Connecticut, who is the grandson of the writer of the manuscript, in his ninety-third year. He recalls hearing his mother, who was the daughter of the narrator, tell of her father's experiences much the same as here recorded, and also of hearing her tell of scenes in the American Revolution.

On the Sloop "Dove" bound for the far Mediterranean

"In less than one month after my arrival, I again embarked on board of the sloop 'Dove,' Captain Meigs, bound to Italia. In about eight or ten days after our departure we observed a heavy rolling sea, which appeared very singular, as we had but very moderate weather for three or four days previous to our observing this strange tumult in the watery element. This weather continued until about one of the clock the next day, when a heavy gale of wind set in from the southward and westward. Every exertion to save the vessel proving useless, we gave ourselves up for lost. The vessel soon after upset. Captain Meigs being in the cabin at the time was with much difficulty saved from drowning. We, however, made a shift to hang on to the upper gunnel for the span of ten hours, which brought night, but gave us no encouragement, as the storm continued to increase. The vessel being laden with live stock on deck and lumber in the hold, with some barrels of flour, kept

Journal of Captain Samuel Hoyt—Born in 1744

her on the surface of the water, although filled.

“Soon after she upset we observed the boat (to our great satisfaction) was lashed to the windward gunnel, and of course was out of water. Upon my observing the lashing to be out of water, I made a shift to get to it, and cut the boat loose with a small knife I had saved in the general consternation. We all being without clothes, except trousers (our hats having been washed overboard some time before night) we had no knife excepting the one just mentioned, this being too small for a sailor’s use, yet notwithstanding by careful management it proved a means in the hand of Providence of saving the whole crew from a watery grave. Soon after the boat was cut loose by this small knife, we made a shift to get her into the water the leeward side of the wreck.

“After trying some time to free her from the water which was in her, without success, we, however, succeeded at length in clearing the coat of water, and by giving her a large scope of rigging for a painter, we succeeded in keeping her above water. We now began to consider what would be the best means possible for our preservation. After reflecting upon this subject a short time, we unanimously agreed (as we had no provision or anything to support nature, except about one gallon of rum which we found washed out of the cabin in a small keg) as soon as daylight appeared to risque ourselves in the long-boat, in hopes of falling in with some vessel. For the purpose of putting our plan in execution, we hauled alongside of the wreck, and found means of getting the topsail, which lay in the buckets. We next undertook to get into our possession the topsail-yard, which with much difficulty we at length effected. After much labor we succeeded in cutting the yard in two, and making a mast for the yawl; the topsail with a slight alteration

answered for a sail. All this was accomplished before daylight, a small penknife being the only tool we had to perform our night’s job with.

Wrecked on the Atlantic Ocean and Adrift in the Storm

“When daylight appeared we cast off from the wreck and commending ourselves to the care of Providence, bore away before the wind. One man was stationed at the helm to steer with a broken arm, a second stood on his knees to bail, while the two others were forced to lie in the bottom of the boat for ballast; and this was our constant situation while we remained in it. For the space of three days we were driven before the wind without any cessation from our labor of steering and hauling as the storm appeared to increase. Neither sun, moon nor stars appeared, and exhausted nature almost sunk under the severe sufferings we were obliged to encounter. The fourth day the gale broke and the weather cleared up, the wind blowing as near as we could guess from the northwest. The sun continued to shine through the whole day, and at night set in a cloudless sky. Night coming on we observed a heavy black cloud arise out of the southwest; a storm of thunder ensued. As soon as the thunder and lightning ceased a violent gale of wind set in from the southwest. Every ray of hope seemed to vanish and we expected no other than that one hour, or even half an hour, longer to live, would be the utmost of our probationary time. When daylight appeared we discovered a large breaker some distance astern and concluded among ourselves that the moment of our dissolution was at hand, when we should be buried in a watery grave. When the breaker overtook us we were for a while buried beneath the surface of the water. The wave, however, left us in a much better situation than we could possibly have imagined. Upon our wiping the water from our eyes,

Adventures on an American Trading Vessel

we again beheld each other with emotions of joy and surprise. We immediately set ourselves to work clearing the boat of water, it being almost even full, (having had forethought sufficient to lash the bucket to the boat before the wave overtook us).

"We soon cleared the boat of water and again secured the bucket as before. We had but just time to secure ourselves and bucket before a second wave, similar to the first, broke over us with great fury. We, however, continued to stick to the boat until this wave had subsided, when, quitting our holds, we again succeeded in freeing the boat from water; the wave ensuing, being the third, was more moderate, and we were again relieved from the fear of immediate destruction. We remained in this perilous situation until the next day, when the captain, worn down with fatigue and trouble, sank under hardships too great for human nature to bear. Nature appeared exhausted, and, unable to support himself longer in an upright position, he fell down into the bottom of the boat unable to help himself in the least. One man by the name of Hand (it seems but a tribute of justice to the memory of William Hand to remark that he, under God, was the means of our preservation. During the whole time of our continuance in the boat he was remarkable for calmness, judgment and perseverance, and after the captain was deprived both of strength and reason, Hand's courage and patience were not exhausted in the least), was the only person able to steer the boat.

"About the middle of the day the sun made its appearance through the clouds, which, excepting one day, had been hidden from our sight by clouds and darkness ever since we were shipwrecked. During the whole period we had never discovered a vessel and all hopes of life seemed to be taken away; but that ever gracious Being, who hears the cry of the raven and condescends to regard the minutest

occurrences of life, saw all our affliction and had determined to grant them relief. About three of the clock, as near as we could judge, we espied a lofty ship, but as she was plying to the windward and we were obliged to sail before the wind, the probability of our being discovered by the ship was so small that we in a measure gave up all hopes of being saved. Yet was the hand of Providence visible at this time, it being about four o'clock when we passed the ship. We had but just passed her, when the watch on board of her being called, the man who was going to take the helm, stepped forward to take an observation of the weather, and looking around, observed our boat at a distance, but could not ascertain what it was, as it instantly disappeared in the hollow of a sea. He stood till it arose to his sight the second time, when, being convinced it was in reality a boat, he cried out to the officer of the watch: 'A boat! A boat!'

Heroic Struggle Against the Elements—and a Rescue at Sea

"The ship's courses were immediately hauled up in compliance (as we afterwards learned) with the orders of the chief officer on deck. They soon gave her stern way, by throwing her topsail aback (the wind blowing too fresh to admit of their heaving about, and standing down for the purpose of catching us) and proceeded down for us; after coming within hail, an officer on board of the ship called out to us to be of good courage, saying at the same time to his men on board: 'Get a line ready, my boys, we will soon catch them.' When the ship came alongside of us, the first mate (to whose generous exertions we were at this time indebted) asked us if we could hold on to a rope. We replied that we thought ourselves too much exhausted by long abstinence and fatigue to perform any service that required much bodily strength.

Journal of Captain Samuel Hoyt—Born in 1744

He then directed us to fasten it to the boat by taking two or three turns round the forethought after having passed it through the ringbolt. A rope was then thrown us, and, we obeying the mate's directions, were soon alongside of the ship. We were, however, so much exhausted that we found it impossible to gain the ship's deck without assistance. The mate seeing the condition we were in, commanded some of his men to jump into the boat and assist us in getting on board.

"When we found ourselves once more out of immediate danger our happiness was indescribable. The mate then desired us to make ourselves as comfortable as possible while he secured the boat (it being a very handsome yawl). Captain Meigs was too far gone to realize what had passed, and was laid gentle on the deck, while the mate was hoisting the boat on board. The captain of the ship now made his appearance on deck for the purpose (as it appeared) of inquiring how long we had been in the boat and whether we had lived without food for any length of time. Upon his being answered in the affirmative, he replied: 'And what would have become of you if it had not been for me?' We remarked for answer that we must soon have perished. The captain then turned and went below where he remained until the Sabbath ensuing. We were then taken to a fire and stripped of our remaining clothes (which were shirts and trousers) as they had not been dry a single moment since our shipwreck. Upon the mate's inquiring which we stood most in need of, victuals or drink, we informed him that our thirst was the most distressing. Accordingly he made us some weak sling, and after a short time he gave us a small quantity of boiled rice together with a small piece of bread and cheese, which seemed more like aggravating when relieving our enraged appetites. His precaution was

undoubtedly the most safe method he could devise for those incapable of using judgment for themselves. After we had supped we were removed to another apartment and furnished with a comfortable field bed, and as we had been for a long time a stranger to 'Nature's kind restorer, balmy sleep,' my companions soon fell into a sound sleep, which I found impossible to do, without first satisfying in some degree my enraged appetite.

At the Mercy of a Strange Crew after Long Suffering

"I had not remained long in this situation before several of the ship's crew came down for the purpose of getting a bite of cold-junk (as they termed it). Unfortunately for me, they supped in the same room where I lay. I lay all the time they were at supper entirely still, not making the least noise for fear of being noticed, wishing to keep them in entire ignorance of my voracious appetite keeping me awake while my companions were asleep. After they had finished their repast, they, laying aside their victuals and drink, returned on deck. As soon as they were gone I crept off from my bed, and being too feeble to walk, I made the best of my way toward the place in which I saw the sailors deposit their victuals, on my hands and knees. Having arrived, I loaded my hands with meat and bread, and leaving the locker, I crept to a large can filled with water, with a full determination to drink only three swallows; but, alas! how feeble are our resolutions when crazed by enraged appetites! I put it to my mouth and before my judgment could come to my assistance, I had almost emptied the can. I now undertook to crawl back to my bed. I had not proceeded half way before I was taken suddenly ill and remained where I was, being totally unable to proceed farther. I remained in this situation during the remainder of the night, being racked

Adventures on an American Trading Vessel

with the most excruciating pains that man ever suffered by imprudence.

"Having no one to blame except myself, I determined, if I must die by my own hand, to leave the world in ignorance of the nature of my complaint. A little before day, oppressed nature seemed to exert itself to her utmost, and after having discharged the contents of my stomach, I felt myself so much relieved that I was enabled to regain my bed. In the morning the mate came down to see how we fared, and when he learnt what I had been about through the night, he exclaimed: 'Thank God that you are still alive.' In consequence of the humane attentions of our new friends, Captain Meigs and crew gradually regained their health. I remained ill much longer than any of my companions on account of my imprudent conduct. The Sabbath morning after we had been taken on board the ship, the boatswain, who had charge of Captain Warner's watch, had the politeness at eight of the clock to go down and inform him of the time, that he might as usual give orders to call another watch. The captain replied that he would tell him whether it were eight o'clock or not. He then took a quadrant and came up with a disturbed air, and after looking some time at the sun, said: 'It is not eight yet.' After this his manners continued to be very singular during the forenoon, and his motions were unusually precipitant.

Sad Fate of Ship's Captain who Loses his Life in Delirium

"At twelve o'clock the mate took his observation and went below to perform his necessary labor of navigation. In the meantime the captain was on deck, and after advancing to the side of the ship, took a handkerchief from his pocket and applied it to his eyes. He then (after taking it away from his eyes) looked around to see if anyone observed him, and, thinking himself unnoticed, actually

proceeded to tie it over his face. The man at the helm had narrowly watched all his strange manœuvres, and instantly cried out: 'The captain is going overboard!' The mate then ran from the cabin, seized hold of his clothes just as he was plunging over the side of the ship and pulled him in with such fury that they both fell backwards on deck. After struggling a few moments, he disengaged himself from the mate and ran up to the fore-castle, and made a second attempt to leap overboard, being prevented by some of the sailors; he seemed to be more calm; while the officers held a consultation for the purpose of determining what was best to be done with Captain Warner. As they considered it to be a hazardous thing to put their commander under close confinement, they chose rather to watch him on deck. They accordingly placed him aft, where he continued walking the remainder of the day. He soon after became agitated and often prayed earnestly with an audible voice. At the close of his prayers he would exclaim with much emphasis: 'Oh, if I must be buffeted, I must be!' Towards night his agony appeared to increase and he prayed with greater frequency and earnestness. In the evening a light being placed in the binnacle, as the captain walked past it, the light discovered to us large drops of sweat standing upon his forehead.

"Not long after he imagined that he saw a fire-ship and directed the helmsman to change his course. The mate (by the name of Sowards) endeavored to pacify him, and ordered the man at helm to steer, as he had done before. The captain insisted that it was a fire-ship and that it was making towards them very fast. He then ran to the helm and placing it hard up, ordered the yards to be quared immediately, apparently with a view to our preservation; yet after some time Mr. Sowards prevailed on him to let him take it, and in order, if

Journal of Captain Samuel Hoyt—Born in 1744

possible, to divert him, called out: 'Boys, get up the guns on deck; it is the devil that Captain Warner sees; silver will kill him. We will put all the money we have into the guns and shoot him.' But the captain's mind was too gloomy to be amused by this stratagem. Shortly after, he remarked that the ship was near at hand and took a speaking trumpet and hailed her. He then applied it to his ear as if to hear the reply.

"After listening a while he again put the trumpet to his mouth and cried out: 'Oh! Do spare me a little longer!' After again waiting as if to know the result, he mournfully exclaimed: 'Oh! if I am to be buffeted, I must be!' He then observed that the boat was coming from the fire-ship, and said: 'Boys, man the sides.' Accordingly, two men descended to the side of the ship with their hats under their arms. This was only customary civility and performed to honor gentlemen when entering and returning from a ship. He then made the compliments which are usual when gentlemen of distinction came on board, and said: 'Sir, will you please to walk below?' and immediately repaired below into the cabin, where he continued fifteen or twenty minutes. So novel and surprising was the same that not a loud word was spoken on deck during the whole time.

"When Captain Warner again came on deck he seemed to compliment a departing stranger, and gave orders to man the sides. His orders were immediately obeyed and two men descended as before. He next made a short prayer, and afterwards took a gold watch from his pocket and offered it to the mate. 'Here,' said he, 'Mr. Swards is my watch; keep it to remember me, for I have not long to stay without.' 'I don't know what you mean, Captain Warner,' rejoined Mr. S——, 'by not having long to stay; I don't want your watch, for I have one of my own.' The captain

then laid it on the binnacle, and Mr. Swards, thinking it unsafe to have him remain longer on deck, prevailed on him to go below. Having occasion shortly after to leave the cabin, he directed one of the people to remain in it, and if anything happened to call for help. It was not long before the man cried out, and when Mr. Swards came to his assistance he found Captain Warner suspended out of the cabin window. They both succeeded in drawing him in, and after shutting the windows, Mr. Swards stationed three men before each window to guard them.

"After this Captain Warner continued walking for a few minutes. All on a sudden (to the astonishment of the whole) he seemed actuated by supernatural springs, for turning upon his heel (as he was walking from the windows) he appeared to spring at least the distance of eighteen or twenty feet, passing out of the window head first, and carrying it together with the frame and case-ment along with him. Mr. Swards then hastened on deck, and, bursting into tears, gave orders to have the ship immediately put in stays. He then repaired aft and called out: 'Captain Warner! Captain Warner!' with a loud voice, but received no answer. After they had made two unsuccessful attempts to heave the vessel in stays, he (the mate) ordered to have the boat immediately cleared.

At Leeward Islands after Several Tragedies at Sea

"After the men had obeyed their officer's commands in clearing the boat, they inquired if it were best to throw the boat over, as nothing was to be seen or heard of the captain. Mr. Swards made answer that he thought it would be entirely useless to throw the boat over, adding that the captain went off very strangely without leaving any wake on the surface of the water, which was discernible to any man aboard, or even without leaving

Adventures on an American Trading Vessel

them any room to conjecture what had become of him. The former mate (now master) of the ship then gave orders to have the light sails all taken in and the others closely reefed, and continued them in a similar situation, (notwithstanding the lightness of the breeze) until the next day, when his men enquired the reason of his shortening sail, as the captain was irrecoverably lost. He replied that the ship and cargo were Captain Warner's and that if the devil had such power over him, he knew not how much he might have over his property. Mr. Swards continued to prosecute his voyage, and thirty-seven days after arrived at Antigua. Just at evening we approached the mouth of Param Harbour, where we anchored during the night.

"In the morning we were much surprised to find that Mr. Boling, our then chief mate, did not as usual make his appearance. After waiting impatiently for some time Captain Swards sent to his stateroom and expected to be informed that he was within sick or dead, but upon investigation it was found that neither he nor anything belonging to him was on board. We afterwards learned that the night preceding his elopement he had privately hailed a boat of negroes and prevailed on them to convey him to one of His Majesty's ships-of-war, choosing rather to be anywhere than in that melancholy place (as he termed it.) After sailing up the Harbour Captain Swards landed us in the same destitute circumstance of money and clothes as we were when taken on board the ship. A number of gentlemen soon collected on shore and inquired of Captain Swards where he was from. 'Portsmouth, N. H.,' was his reply. They then asked him what news he brought. He answered that it was very bad, and proceeded to inform them of our having been taken up by him when almost famished for the want of food and rest. He then proceeded to inform

them of the awful event which had deprived him of his captain.

"As soon as Mr. Swards had finished his narrative these humane gentlemen gave us an invitation to walk up with them to a Public House, which stood near by, and after feeding and clothing us, had a subscription made up for the purpose of alleviating our pecuniary wants for the present. We had been in port but a few days when to our great joy we learned that Captain Vail (one of our former acquaintances) was just arrived at the port of St. Johns in the same Island. All of us (except Capt. Meigs) repaired thither immediately, where we met with a kind reception from our old friend, Captain Vail. About eight or ten days after we arrived, Captain Meigs made his appearance laden with presents which he had received from his truly noble and disinterested patron in Param.

The Sea-farer's Home-coming Back in old New England

"Soon after I embarked on board a vessel bound for New London in North America, which was short of hands, and after a passage of fourteen days (having been about three months) arrived safe in New London, and from thence proceeded home by land; found my friends well at Guilford and pleased at my return. They were, however, much surprised at my coming home alone, and still more were they surprised by hearing the recital of my voyage. Captain Meigs and one of my brothers in tribulation had the happiness of reaching home the same evening on which I arrived. Next day, being Sabbath, Captain Meigs, myself and the sailor who accompanied the Captain home, attended Divine Service and jointly offered up a tribute of Gratitude and Praise to our Almighty Preserver and Benefactor, who had saved us amidst the furious Seas! In the interval between the meetings Wm. Hand

Journal of Captain Samuel Hoyt—Born in 1744

arrived. He attended public worship in the afternoon and returned public and hearty thanks to Him, whom the winds and seas obey, for his safe return to his family and friends.

"After a sufficient length of time had elapsed since my arrival I inquired of every person which I thought likely to be able to give me any information about Captain Seward, but without any success, until near three years afterwards, when I saw the former boatswain of the ship and learned from him that after we left the ship the hands became frightened and would continue in her no longer; that Captain Seward offered to advance him to the office of Chief Mate if he would remain with him, but that he (the boatswain) was unable to reconcile his mind to the idea of staying, and consequently obtained a dismissal; that the Captain shipped another crew, but they also became timid and deserted the ship.

"After Captain S— had discharged his cargo he took a freight of sugar for London, but was forced to hire laborers by the day to load the vessel. He was then obliged to contract with a ship's crew only for the run, and when he reached London was again left alone. And being very much discouraged he sold the ship and cargo to free himself from any further embarrassment, and had never (to his knowledge) made any returns of the voyage previous to that period. But to return to my narrative.

A Voyage on the Brig "Delight" to Barbadoes in 1763

"Near the close of the year 1763 I again embarked on board a brig, called the 'Delight,' bound to Barbadoes. The repeated losses which I had sustained sat heavy on my mind and I resolved once more to attempt repairing them. I shall omit mentioning particulars for fear of trespassing upon the patience of my reader, and only observe that after a

quick and pleasant passage we arrived at our destined port in high spirits and good health. Soon after our arrival at Barbadoes we landed our cargo, and leaving the captain to dispose of the property (the Mate taking charge of the Brig) proceeded to Salt Tudas (?) for the purpose of procuring a load of salt. When we arrived at that place we found ourselves under the necessity of transporting the salt the distance of one mile by land over a rough and almost barren country. This so much impeded our progress that fourteen days elapsed before we had finished loading the Brig. During this time a great part of our provisions being exhausted, and the Island without inhabitants, we could obtain no provisions to recruit our almost exhausted stores without endangering our lives and property, as Great Britain and Spain were at open hostilities and we on a Spanish coast surrounded by enemies; we were obliged to proceed on. Notwithstanding our scanty allowance, ten days after we left the Island, our small store of provision being divided we found to our sorrow that twenty biscuits and four pounds of meat per man was all we had to depend upon during the remainder of our voyage, which proved very long.

"Thirty days elapsed before we were able to obtain a fresh supply. In the meantime, after our provisions were exhausted, we betook ourselves to a new occupation, even that of catching rats, which was all we had to subsist on for the space of five days. Even these animals were so emboldened by hunger that they frequently sallied forth from the scaling of the vessel and attacked us when asleep. Several of our people were badly bitten by them, losing large pieces of flesh from our hands and feet. During the passage we had never spoken a vessel, and as we had often experienced contrary winds, hope the only friend of the unfortunate, had almost taken his flight from on board our

Adventures on an American Trading Vessel

famished ship. Just as the time that we made the N. American Coast we fell in with a vessel bound to the West Indies, of whom we obtained some fresh supplies of provision, which so much enlivened the ship's crew that joy was perspicuous in every countenance, and every eye sparkled with hope of soon again beholding their beloved friends. Soon after we parted with the vessel that supplied us; a favorable breeze sprang up, and in the space of four days we arrived in Guilford, found our friends all in good health and pleased at our safe return, after an absence of five months and ten days.

Bound for the Island of Jamaica, West Indies, in 1764

"In June 1764, I again shipped on board the same Brig and set sail for Jamaica. Fortune at length, seeming tired of opposing one who had so long been her sport, made some amends by giving us fair winds and a quick market. Soon after we arrived in port one of the mates sickened and died. We soon accomplished our business in port and set out on our return home. Not long after we left Jamaica we were overtaken by a terrible hurricane, which carried our mast by the board, and left us a complete wreck, for the winds and seas to toss us wherever Providence saw fit. Through the protecting hand of Heaven our lives were preserved, but at the close of the hurricane our vessel presented

us with a dreary prospect, not having a strand of rigging on deck except the main ropes. We, however, by unwearied exertions, erected jury masts, which in seventeen days (the weather being good) brought us to our desired haven, viz.: Guilford.

"After remaining with my friends a short time I again made a voyage to Jamaica. It proved to be fortunate, and no unusual event occurred during my absence from Guilford. Subsequent to my return I continued at Guilford several months, and was busily employed in repairing a small house, which I had just purchased. Not long after I engaged another trip for the West Indies, but was prevented by a fall from my house, which at first I looked upon as a severe misfortune, but Providence meant it for my good. The vessel in which I had designed to sail was (owing to contrary winds) sixty days on her homeward bound passage without being able to reach the American coast during which time the person who sailed in my room was lost overboard, and they were finally obliged to return to the West Indies before they could terminate the voyage."

The journal of Captain Hoyt now enters upon a narration of his experiences in the years just before and during the American Revolution. His thrilling story of adventures in these "knighthood days in America" make another interesting chapter.



In the First Homes in America

BY CLARA EMERSON BICKFORD



BROUGHT TO AMERICA FROM PARIS BY PRESIDENT MONROE

Purchased by Judge Philip Norbonne Nicholas of Richmond, Virginia, from President Monroe, and now belonging to Miss Elizabeth Byrd Nicholas of Washington. Wood is hard, yellow, picked out with gold and female figure and scroll-work in bronze; covering sky-blue satin with yellow cording around cushions

CENTURIES before the Christian era the Egyptians had chairs of wood with cane seats and large and easy arm-chairs with cushioned seats and beautiful decorated couches and wall hangings. This was an age of magnificent leisure, and the Egyptian physical civilization seems to have been as carefully organized as that of modern Europe and was maintained for a time, which dwarfs by comparison all the epochs of Europe. The Assyrians are shown in their bas-reliefs seated on couches and thrones, with bedside tables and stools, vases and dishes of varied form. The tables are lower than the couches, as would be more convenient. The ancient Persians and the people of Asia Minor had rich furniture.

The people of India have been makers of magnificent articles of mingled use and beauty from time immemorial. The great Empire of China is rich in the history of decoration and furniture, combined with custom, tradition, and strong family and ancestral feeling, prolonged through untold centuries. From Greek and Roman antiquity come the marble tables and lamp-stands. The bronze articles of utility Pompeii has preserved for modern times, but little else has been learned with any certainty. Small tables were brought to the distinguished guests in Homeric times, one for each guest. The custom of removing the tables with all on them and bringing others, was also a later Greek practice. In the Roman triclinia or dining-rooms the whole table was removable at one time, and at a later

In the First Homes in America



FROM LIBRARY OF NAPOLEON I

At Malmaison, and given by Louis Philippe to Marquis De Marginy of New Orleans. This model is mahogany and has survived for many years

time, the leg or upright of the table was made permanent, and only the top movable, and intended to be changed with the changing services. Tablecloths came in with the Emperor Tiberius.

In America the well-to-do cavaliers who came to Jamestown in 1607 were lovers of comfort and art and it was not long before they began to import rich furniture from Europe. The next century was one of magnificence and many of the homes along the Atlantic coast were abodes of ease and elegance.

An American antiquarian, Esther Singleton, has made an exhaustive study of the evolution of household decoration in the New World, and finds that America is to-day a treasure-house of magnificent heirlooms,

many of which have descended nine generations. The drawings here shown are from originals found in American homes by Miss Singleton and recorded in her book by Doubleday, Page and Company of New York. The history of furniture is so closely related to intellectual development that through it may be reflected a composite of a people's culture.



BROUGHT BY EMIGRANTS IN 1633

The first comers to America brought many oak chairs with rich carvings—This is a specimen of the beautifully carved oak chairs of a later period

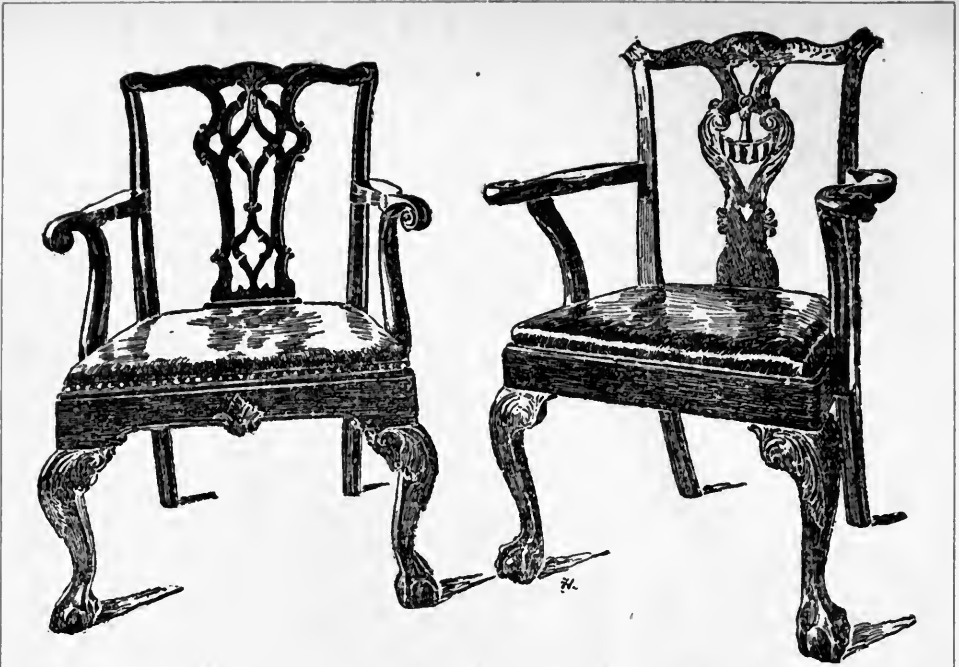

EARLY COLONIAL MAHOGANY CHAIRS IN AMERICA

The chair on the left is similar to the model in South Kensington, dated 1732—The one on the right resembles the models dated about 1750—Drawings from originals by Doubleday, Page and Company of New York

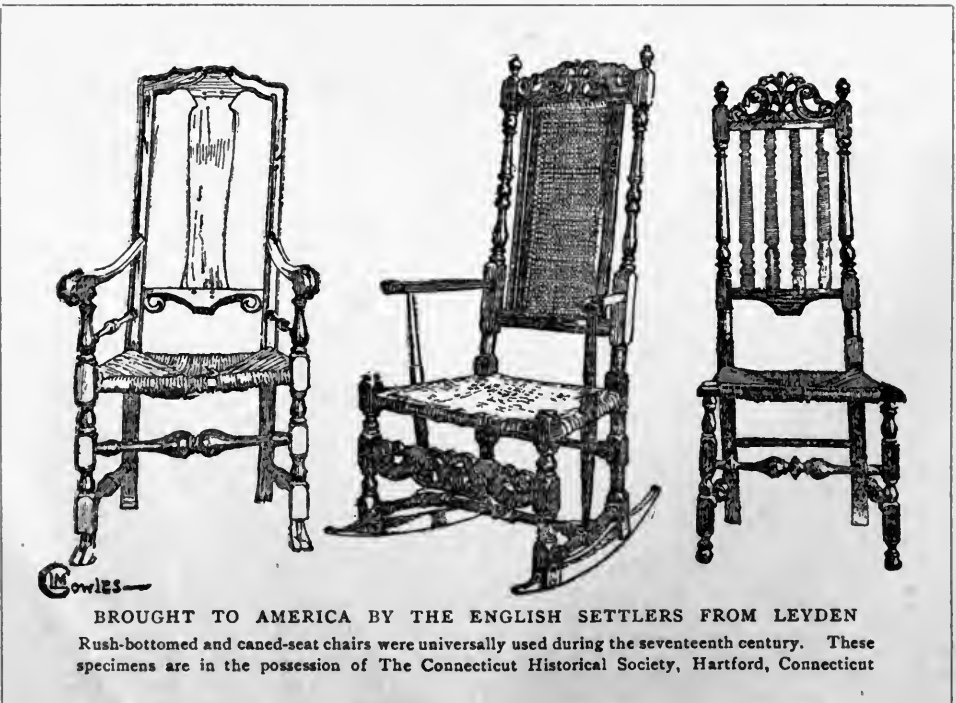

BROUGHT TO AMERICA BY THE ENGLISH SETTLERS FROM LEYDEN

Rush-bottomed and caned-seat chairs were universally used during the seventeenth century. These specimens are in the possession of The Connecticut Historical Society, Hartford, Connecticut

Secret Service of American Revolution

Incidents in
which Imminent Defeat was
turned to Glorious Victory & Repressing
the Ravagers of Property on the Outskirts of the Army &
Anecdotes of Colonel Henry Ludington, Born 1739, and the Heroism
of His Daughters who Saved Him from Capture and Execution & Related

BY

LOUIS S. PATRICK

MARINETTE, WISCONSIN

WHO HAS MADE AN EXHAUSTIVE STUDY OF THIS PHASE OF THE AMERICAN REVOLUTION

THE American Revolution made many strong men—daring fighters who were willing to lay down their lives for their cause. There is another type of strong manhood that took an important part in the American triumph—men whose wit and invention thwarted the plans of the enemy and turned imminent defeat into glorious victory.

This is a true story of what might be termed the "secret service." It relates the life of a man of whom little is recorded but whose services to his country were such that justice should be done his character.

There was a band of "lurking miscreants, not properly enrolled, who stayed chiefly at Westchester, New York, from whence they infested the country between the two armies, pilaged the cattle and carried off the peaceful inhabitants. The Whig inhabitants on the edge of our lines, and still lower down, who had been plundered in a merciless manner, delayed not to strip the Tories in return. People, most nearly connected, allied frequently, became the most exasperated and inveterate in malice. Then the ties of friendship were broken, then friendship itself being soured to enmity, the mind readily gave way to private revenge, uncontrolled retaliation and all the deforming passions that disgrace humanity. Enormities almost without name, were perpetra-

ted, at the description of which, the bosom, not frozen to apathy, must glow with a mixture of pity and indignation."

This is the narrative of a man who undertook the breaking up of these marauders and incurred their direst enmity; a price was placed on his head and several spies sought his capture and the reward. The story of his experience is most entertaining.

Whether his early life brought him any material advantages over his associates, or that he enjoyed greater privileges or opportunities more than parents of ordinary means and culture could give, there appears to be no substantial evidence. However, traits of character indicative of the future man became manifest at an early age. The beginning of the French and Indian War found him ready and willing to enter the military service, and inspired by the love of adventure, having a fearless and independent nature, a resolute character coupled with a military spirit, at the age of seventeen, he enlisted under the King's proclamation and marched to the frontier where he saw service and gallantly and creditably participated in three campaigns, and remained in the service until nearly the close of the war. He was present and took part in the battle of Lake George, where he saw his uncle killed and a cousin mortally wounded. It is the story of an heroic American youth.

Anecdotes of Colonel Ludington—Born in 1739

COLONEL HENRY LUDINGTON was born in 1739 and his experiences were those known only to the founders of the nation. While a mere boy, he was detailed to

escort a company of invalid soldiers from Canada to Boston. This perilous duty and journey through the wilderness, undertaken in the dead of winter was one of almost incredible hardship and suffering. At times, compelled to subsist upon the twigs of the trees and with no protection at night but their blankets to shelter them from the inclemency of the weather, the gallant young leader braved the dangers and privations of the march and successfully accomplished the duty assigned.

The young soldier possessed a genial and a companionable disposition. Military life and discipline, and the toil and hardship of the campaign were not sufficient to hold in check his buoyant nature or to repress his indomitable spirit. He loved practical jokes and was always fond of putting them into execution. On the march to Canada, he was ordered with other men under the command of a sergeant to proceed to cut out a road for the army through the wilderness, a task not to his liking. In order to avoid this duty, he cautiously sought his tent, disguised himself and soon after joined the company, which had already taken up the line of march. As he came up with them, he ordered the sergeant into the ranks and took command himself. The sergeant was inclined to dispute his authority and to resist, but of no avail. The self-constituted officer threatened to report him if he did not obey and promptly and quietly yield. The ruse and the disguise was so complete that no one recognized him or even suspected his authority. When the detail returned to the camp, quickly and unobserved he reached his tent, resumed his ordinary dress, having to all intents and purposes

obeyed the order of his superior officer and performed his full share of the work ordered. Not so with the yielding sergeant; he was court-martialled and punished. The young soldier's superior tact and naïveté saved him.

Soon after his Canadian campaigns, young Ludington married his cousin, Abigail Ludington, a daughter of Elisha Ludington of Branford, Connecticut. This event occurred May first, 1760. The young couple, with their parents and the members of their families, left Branford and sought a new home to the westward. This they found within the limits of the Phillips Patent which afterwards became Fredericksburgh Precinct, Dutchess County, New York, and later by enactment in 1812, the town of Kent, Putnam County, New York. The location of their home was on the north end of Lot Number Six of the Phillips Patent. Only one other settler had preceded them, and the whole country about them was a dense wilderness. Family tradition alone explains why this selection was made. The lands were fertile and cheap, the pasture for the stock abundant and easily obtained, the water good, the place healthy and pleasant and free from many of the ills pertaining to new settlements. However encouraging and alluring the inducements were for settlement, the rocky and rugged hills and the valleys of this region had obstacles not so easily overcome. To till them and to bring them into cultivation required patience and industry. The young pioneer was neither discouraged nor dismayed by his surroundings. He planned and wrought on a broad scale. Fertile acres were developed and his enterprise and industry were rewarded by large possessions. Nor was this all; his address, capability and integrity brought him influence and authority.

Soon after Ludington's entry into Dutchess County in the Province of New York, he was appointed a sub-

The Secret Service of the American Revolution

sheriff. He took the oaths of office March twelfth, 1763; one of abjuration and the other of fealty to the Sovereign, which were prescribed for officers on the accession of George the Third to the throne of England. These oaths are quaint relics of a by-gone custom and authority.

His oath of abjuration declared his belief "that there was no transubstantiation of the elements of the bread and wine into the body and blood of Christ at or after the consecration by any person whatsoever." His declaration of loyalty to the King by the second oath was of no uncertain character. By it he pledged himself to remain faithful to the King and to defend him against all traitorous conspiracies and attempts against his person, crown and dignity to the utmost of his power, and particularly to uphold the succession of the crown against the claims of the pretended Prince of Wales, who had styled himself King of England under the name of James the Third.

At this time, the ominous signs of the coming storm, the American Revolution, were visible. Events, particularly in the New England colonies, were such as to give strength and power to sentiment of open rebellion, yet it is evident that his loyalty to the government had not been disturbed, nor had the culminating events swerved him from his adhesion to his oath, neither had his obligations weakened to his Sovereign from the character and nature of these oaths. His fidelity remained unquestioned and William Tryon, the captain-general and governor of the Province of New York, under the forms of issuing commissions, "reposing especial trust and confidence, as well in the care and diligence, as in the loyalty and readiness to do his Majesty good and faithful service," appointed him captain of the fifth company of the second battalion of the Fredericksburgh Regiment of Militia in Dutchess County. Captain Ludington's commission was given in the city of New York on the

thirteenth day of February, 1773, and on the second day of April, 1773, Henry Rosenkranz certified: "that the within Henry Ludington had taken the oaths as by law appointed and the oaths of his office." He retained this command until the commencement of the Revolution.

However loyal Sheriff Ludington may have been in his allegiance to the authority of George the Third, when the fires of patriotism were awakened by the signal guns at Lexington, then self-interest and fidelity to the King was forgotten. He espoused the cause of the colonists with alacrity. The time for action found him vigilant, aggressive, ready to meet arbitrary power and armed operations. His patriotic zeal made him an unhesitating, energetic, open patriot. Once within the patriots' ranks, his ardor, military experience and judgment gave the cause of independence a zealous defender and a conspicuous advocate. He recognized the importance of prompt action, believing that delays were fraught with danger. Early in the struggle, he took decisive and vigorous measures to sustain the Provincial authorities of New York. In conjunction with Joseph Crane, Jr., Jonathan Paddock and Elisha Townsend, Jr., who were leading men and influential persons in his county, he addressed a letter to the Honorable Council of Safety of the State, defining the action they had taken at the universal call of the people to prevent the removal of flour from that part of the state and to effect the detention of one Helmes who had been purchasing wheat and flour and was then moving it from Fishkill towards Newark. This man's presence with them was of doubtful character and his conversation was of a "disaffected nature." The well "effected people" were universally displeased at this state of affairs. "Nothing," said they, "but the strongest necessity could induce us to trouble you with an application of so extraordinary a nature, but, if

Anecdotes of Colonel Ludington—Born in 1739

we are esteemed worthy of your confidence as friends of our struggling country, our sincerity will atone for what in common cases might appear indecent." "Our invaded state," they said, "has not only been an object of special designs of our common enemy but was obnoxious to the wicked mercenary intrigues of a number of jockies, who had drained that part of the State of the article of bread to that extent that they had reasons to fear there was not enough left to support the people."

In the organization of the Dutchess County Militia for the Revolutionary service, previous training and services gave Colonel Ludington conspicuous prominence. During the winter of 1775-6 he was appointed a second major in Colonel Jacobus Swartout's Regiment of minute-men in Dutchess County, and when its first major, Malcolm Morrison, resigned, Ludington was appointed in his place March tenth, 1776.

The next command to which he was nominated was that of lieutenant colonel. The general committee of the county decided on May sixth, 1776, to divide and reorganize the southern regiment of militia into two regiments. The regiment of which he was to be the lieutenant colonel included all the militia in the Fredericksburgh Precinct (except the middle and north short lots), and all the militia in the Phillips Precinct in Dutchess County. The regiment was to remain unregimented until the officers received their commissions, but the Provincial Congress of the Colony of New York commissioned him colonel in June, 1776, his command being as already described. This commission was superseded by another granted to him by Governor George Clinton, the first governor of the State of New York, issued at Poughkeepsie, May twenty-eighth, 1778, ordering him to take command of the regiment hithertofore commanded by him. This rank he held throughout the war and for many years afterwards.

The locality in New York in which Colonel Ludington lived, and to which his regiment belonged, was in close proximity to the Neutral Ground of New York. It was the shortest route to New York and the most direct line to Connecticut and other points in the farther East. The important post of West Point was only twenty miles away, while to the west, three miles, rose the crest of the Highlands of the Hudson, overlooking Fishkill and Newburg in the valley below. Owing to the directness of the route, this locality became strategic and advantageous to direct the movement and concentration of troops in any direction whenever an emergency required. The ease and readiness by which his command could be diverted and concentrated, brought Colonel Ludington's Regiment into active and constant service in the counties of Dutchess and Westchester, either to assist the regular troops or to quell the turbulent Tory spirit of that section, or to repress the vicious and exasperating conduct of the "Cowboys and Skinners," who infested the Neutral Ground.

"In this section," says one record, "the condition of affairs was truly deplorable. Small parties of volunteers on the one side, and parties of Royalists and Tories on the other, constantly harassed the inhabitants and plundered without mercy friend and foe alike. To guard against surprise required the utmost vigilance. Within this territory resided many friends of the American cause, whose situation exposed them to continual ravages by the Tories, horse-thieves and cowboys, who robbed them indiscriminately and mercilessly, while the personal abuse and punishment were almost incredible."

From this section and by the aid and co-operation of these lawless gangs, General Howe, the commander of the British forces in and around New York, obtained largely his supplies of cattle and grain. Colonel Ludington's activity and vigi-

OATH OF ALLEGIANCE TO KING GEORGE III

Sworn to by Colonel Henry Ludington on March 12, 1763, in Dutchess County in the Province of New York, before he was allowed to take office as a sub-sheriff—Accurate Transcript

I — do Sincerely Promise & Swear, that I will be faithful and bear true Allegiance to his Majesty King George the Third, and I do Swear, that I do from my heart, Abhor, Detest, and Abjure, as Impious and Heretical, that Damnable Doctrine and Position, that Princes Excommunicated and Deprived by the Pope, or Any Authority of the See of Rome, may be Deposed by their Subjects or any other Whatsoever, and I do Declare that no Foreign Prince, Person, Prelate State or Potentate, hath or ought to have, any Jurisdiction, Power, Superiority, Pre-eminence, or Authority Ecclesiastical or Spiritual Within this Realm, and I do, Truly and Sincerely acknowledge and profess, Testify and Declare, in my Conscience, before God and the World, That our Sovereign Lord King George the Third, is Lawful and Rightfull King of this Realm, and all other Dominions and Countrys Thereunto Belonging, and I do Solemnly and Sincerely Declare, that I do believe in my Conscience, that the person pretended to be Prince of Wales, During the Life of the Late King James the Second, and Since his Decease, Pretending to be, and Taking upon himself, the Stile and Title of King of England, by the name of James the Third, or of Scotland by the name of James the Eighth, or the Stile and Title of King of Great Britain, hath not any right or Title Whatsoever, to the Crown of this Realm or any other the Dominions Thereunto Belonging, and I do Renounce, Refuse and Abjure, any Allegiance or Obedience to him and I do Swear, That I will bear Faith, and true Allegiance to his Majesty King George the Third, and will him Defend, to the Utmost of my Power, against all Traiterous Conspiracies and Attempts Whatsoever, Which shall be made, Against his Person, Crown or Dignity, and I will do my Utmost Endeavors, to Disclose and Make Known, to his Majesty and his Successors, all Treasons and Traiterous Conspiracies, Which I shall know to be against him, or any of them, and I do faithfully promise to the Utmost of my Power to Support Maintain and Defend, the Successors of the Crown, against him the said James, and all other Persons Whatsoever, Which Succession, by an Act Entitled an Act for the further Limitation of the Crown and better Securing the Rights and Liberties of the Subjects is and Stands Limited to the Late Princess Sophia, Electress and Dutchess Dowager of Hanover, and the Heirs of her Body, being Protestants, and all these things I do Plainly and Sincerely Acknowledge and Swear according to the Express words by me Spoken, and According to the Plain and Common Sence and Understanding of the Same Words, Without any Equivocation, Mental Evasion, or Senister Reservation Whatsoever, and I do make this Recognition, Acknowledgement, Abjuration, Renunciation and Promise, heartily, Willingly and Truly, upon the True Faith of a Christian—So help me God.

AN AMERICAN'S OATH OF ABJURATION IN 1763

Sworn to by Colonel Henry Ludington when appointed to the office of sub-sheriff—Accurate Transcript from Originals in the Collection of the Poughkeepsie, New York Literary Club

I — Do Solemnly and Sincerely, in the Presence of God, Profess, Testify and Declare, That I do Believe, that in the Sacrament of the Lord's Supper there is not any Transubstantiation, of the Elements of Bread and Wine, into the Body and Blood of Christ, at or After the Consecration Thereof, by any person whatsoever, And that the Invocation, or Adoration of the Virgin Mary, or Any Other Saint, And the Sacrifice of Mass, as they are Now Used in the Church of Rome, Are Superstitious and Idolatrous, and I do Solemnly in the presence of God, Profess, Testify and Declare, that I do make this Declaration, and Every Part Thereof, in the Plain and Ordinary Sence, of the Words read to me, as they are Commonly Understood, by English Protestants, Without Any Evasion, Equivocation, or Mental Reservation Whatsoever, and Without any Dispensation, Already Granted me for this purpose, by the Pope, or any Other Authority Whatsoever, or Without Thinking, that I am or Can be Acquitted, before God or Man, or Absolved of this Declaration, or any Part Thereof, Although the Pope, or any other Person or Persons, or Power Whatsoever, Should Dispence with, or Annul the same, and Declare that it was Null and Void, from the Beginning.

The Secret Service of the American Revolution

lance frequently thwarted the designs of these foes, broke up their combinations, secured the capture of their leaders and his continual activity and effective operations against these marauders and their allies incurred the displeasure of General Howe who aroused an energetic hostility towards Colonel Ludington. To effect the capture of the untiring and zealous officer, dead or alive, a large reward was offered by the British officer. Inspired by this incentive, many attempts were made to capture Colonel Ludington. None were, however, successful.

The most signal attempt to capture the brave colonel and the nearest to success, was undertaken by a notorious Tory named Prosser, whose headquarters were in the vicinity of Quaker Hill, Dutchess County, New York. This leader, while on his way to New York with a large band of his followers to join the British forces, marching in the night time, surrounded Colonel Ludington's house and but for their timely discovery by his daughters, Sibbell and Rebecca, would have captured him. These fearless girls, with guns in their hands, were acting as sentinels, pacing the piazza to and fro in true military style and spirit to guard their father against surprise and to give him warning of any approaching danger. They discovered Prosser and his men and gave the alarm. In a flash, candles were lighted in every room of the house, and then the few occupants marched and counter-marched before the windows and from this simple and clever ruse Prosser was led to believe that the house was strongly guarded and did not dare to make an attack. He kept his men concealed behind the trees and fences until daybreak, when with yells they resumed their march and hastened southwards towards New York, ignorant of how they had been foiled by clever girls. A peculiar incident in later years is that after Prosser escaped banishment he

returned at the close of the war and settled near Colonel Ludington.

Colonel Ludington's life was in danger at another time and by the merest incident he narrowly escaped instant death. A slight noise attracted attention, while he was eating his evening meal, and this slight warning was the means of saving his life. The open shutters were instantly closed and protected him from his assassins. This incident was related to him after the war by one of his neighbors, who was a member of the party, and remarked: "Oh, it is too bad to shoot him while he is eating."

The colonel's most vigilant and watchful companion was his sentinel daughter, Sibbell. Her constant care and thoughtfulness, combined with fortuitous circumstances, prevented the fruition of many an intrigue against his life and his capture.

As unremitting as Colonel Ludington's efforts were, the Tories remained diligent in collecting and drilling bands of men for actual service in the Royal Army. Captain Joshua Nickerson, a noted Tory, collected a large force of men over the swamp in the eastern part of the precinct for this purpose and thorough preparations were made to take them to New York. Colonel Ludington, having been apprised of Captain Nickerson's intention and having obtained accurate information as to the place of rendezvous and their numbers, through a tenant who had enlisted with Nickerson, marched a sufficient force at night and captured the entire number and lodged them in jail at Poughkeepsie. The tenant was subsequently released.

Captain John Holmes was another of the active Tories in this section. His occupation, that of a horse racer, gave him some opportunities and he was the most wary of them all. The British authorities supplied him with money to use as a bounty for recruits. He gathered privately a large number of men and concealed them in a scrub oak field in Fishkill Plain. Colonel

PLEDGE OF THE PATRIOTS TO FREE AMERICA

Signed by Americans in 1776 — Accurate Transcript from Original in Possession of the Misses Patterson of Patterson, New York—Colonel Henry Ludington renounced his former oaths and signed this document at the Beginning of the American Revolution

Persuaded that the salvation of the rights and liberties of America depend, under God, on the firm union of its inhabitants in a vigorous prosecution of the measures necessary for its safety, and convinced of the necessity of preventing anarchy and confusion which attend a dissolution of the powers of government, WE, THE FREEDMEN, FREEHOLDERS, and INHABITANTS of DUTCHESS, being greatly alarmed at the avowed design of the Ministry to raise a revenue in America, and shocked by the bloody scene now acting in Massachusetts Bay, do in the most solemn manner resolve never to become slaves, and do associate, under all the ties of religion, honor, and love to our country, to adopt and endeavor to carry into execution whatsoever measures may be recommended by the Continental Congress, or resolved upon by our Provincial Convention, for the purpose of preserving our constitution and of opposing the several arbitrary acts of the British Parliament, until a reconciliation between Great Britain and America, on constitutional principles (which we most ardently desire) can be obtained; and that we will in all things follow the advice of our General Committee respecting the purposes aforesaid, the preservation of peace and good order and the safety of individuals and property.

PLEA FOR PROTECTION FROM THE ENEMY

Accurate Transcript from Original Letter Written by Colonel Henry Ludington after he had espoused the cause of American Independence and his oaths to the King

DUTCHESS COUNTY, 3D, DECEMBER, 1776.

GENTN.—

Nothing but the strongest necessity could induce us to trouble you with an application of so extraordinary a nature, but if we are esteemed worthy your confidence as friends to our struggling country our sincerity will atone for what in common cases might appear indecent. Our invaded State has not only been an object of the especial designs of our common enemy, but obnoxious to the wicked, mercenary intrigues of a number of engrossing jockies who have drained this part of the State of the article of bread to such a degree that we have reason to fear there is not enough left for the support of the inhabitants. We have for some months past heard of one Helms who has been purchasing wheat and flour in these parts, with which the well affected are universally dissuited.

This man with us is of doubtful character, his conversations are of the disaffected sort entirely. He has now moving from Fishkill toward Newark we think not less than one hundred barrels of flour, for which he says he has your permit, the which we have not seen.—However, we have, at the universal call of the people, concluded to stop the flour and Helms himself until this express may return. We ourselves think from the conduct of this man that his designs are bad.

We have the honor to be your humble servts.

HENRY LUDINGTON.
JOSEPH CRANE JR.
JONATHAN PADDOCK.
ELIJAH TOWNSEND.

To the Honorable the Council of Safety for the State of New York.

Anecdotes of Colonel Ludington—Born in 1739

Ludington, learning of the secret gathering, moved at night with a strong attachment of men, surrounded Holmes and succeeded in capturing him and his troop after a severe struggle. They were taken to Poughkeepsie and imprisoned. Holmes would have been hanged for his traitorous conduct but for the personal exertions of his captor who pleaded in his behalf with Governor Clinton.

Colonel Ludington was closely identified with the first secret service. The home and the labors of the famous Revolutionary spy, Enoch Crosby, the original of Cooper's "Harvey Birch," were in the territory commanded by Colonel Ludington. This humble individual, a shoemaker by occupation, while traveling about the country pursuing his occupation among the people, obtained information of the utmost importance to Washington. Colonel Ludington knew his secret and his object and aided him and sheltered him in the performance of his delicate and hazardous mission. To further prosecute this service, Colonel Ludington furnished numerous successful spies from his own regiment, and with Washington planned many enterprises to obtain definite and trustworthy information concerning the movements, numbers and intentions of the British forces. His services also extended to the Commissary Department in purchasing supplies for the use of the army. Entries in an old account book show transactions at Cambridge, Massachusetts, and also at Annapolis, Maryland.

New York was slow to formulate a state and it was among the last to act. When the time for action came, however, it perfected an organization famed for its liberality, effectiveness and ample provisions. Every department was admirably officered and every possible precaution was taken to enforce and execute the laws and to punish the enemies of the state. The legislature appointed commis-

sioners to quell and subdue insurrection and disaffection in the counties of Dutchess and Westchester. These commissioners, Colonel Henry Ludington, John Jay and Colonel Thomas, were directed to co-operate with a similar one in the Manor of Livingston and were authorized to call in the aid of the militia if necessary, and commanded to use every reasonable means to effect the detection and capture of spies and the secret agents of the enemy.

An instance of Colonel Ludington's experiences is the case of Malcolm Morrison, at one time a first major in a regiment of minute-men, who was charged with accepting the protection of the British government and with raising a company of soldiers for its service. The charge was sustained by the oaths of several witnesses. The committee resolved to commit him to the Ulster County jail January fourth, 1777, there to remain, awaiting the pleasure of the committee or such order as the future legislature of the state might make concerning him. While in Kingston jail, Morrison on February nineteenth, 1777, petitioned the representatives of the state in convention assembled, stating that he had always been ready in advising and assisting both officers and soldiers in the public business, and in a most generous manner had advanced them cash for their relief and was a considerable amount out of pocket on that account, none of which had been paid back, except the £6 lent Colonel Ludington and William Griffin to enable them to find out the pernicious plot of John Miller and Constant Nickerson. The power and the authority that Colonel Ludington had in these matters appears in the testimony of Matthew Patterson, an affiant before the Committee on Conspiracies, who testified that there was a man in the room, meaning Colonel Ludington, who if he knew what Atkins, another affiant, had said, would immediately send him to Congress, but he did not deem it expedient to

The Secret Service of the American Revolution

mention it to him (Colonel Ludington).

Washington selected Colonel Ludington as an aid-de-camp at the battle of White Plains and afterwards complimented him for his meritorious service, gallant conduct and soldierly bearing. The expedition, consisting of two thousand men, sent out to destroy the stores and munitions of war collected at Danbury, Connecticut, under the command of General Tryon, reached that place Saturday, April twenty-sixth, 1777. The guard, too small for protection and too weak for effective resistance, withdrew. Preparations were immediately made to harass the enemy. A messenger was dispatched to Colonel Ludington to summon him to aid in the defence of the place. He arrived in the evening of that day. The members of Colonel Ludington's regiment were at their homes which were miles apart and scattered over a wide territory. To summon them was no easy task. There was no one ready to do it. Sibbell, the young daughter of Colonel Ludington, a girl of sixteen, volunteered to do this service. She mounted her horse, equipped with a man's saddle (some members of the family say without saddle or bridle), and galloped off on the road in the dead of night to perform this courageous service. The next morning by breakfast time, the regiment had taken up the line of march and was in rapid motion towards Danbury, twenty miles distant. The British were in full retreat, but in such force as to prevent an open attack by the forces under the command of Silliman, Wooster and Arnold, who pursued them until they escaped to their boats at the Sound. The expedition was a costly one to them. The loss as estimated was from three hundred to four hundred men—more extensive than Lexington in comparison to the numbers engaged.

The British in the campaign of 1777 had a grand object in view. They intended to penetrate New York

and to dismember the colonies. To execute this plan, Burgoyne and others were to proceed from the northward and westward to meet at Albany and proceed down the river until they formed a junction with the forces under Clinton from the southward, and by this masterly stroke to obtain possession of the commanding points of the state and to effect the isolation of the New England Colonies. Unexpected difficulties, numerous delays and the rapid augmentation of the American Army prevented Burgoyne from accomplishing his part of the project. Messengers were dispatched to Sir Henry Clinton to inform him of the circumstances of Burgoyne and to urge him to make a diversion in his favor and with such force as to scatter the half-disciplined provincials. Clinton, eager to comply, was waiting reinforcements. Washington had drawn a large force from Putnam in the Highlands to aid operations elsewhere and left him with a force composed principally of militia from New York and Connecticut. Putnam, apprehending no movement up the river, had discharged nearly ten hundred of these, leaving his effective force only fifteen hundred men. Clinton, on the arrival of reinforcements, organized an expedition, the chief object of which was to create a diversion in favor of Burgoyne. On Saturday, October fourth, 1777, the expedition proceeded up the river with a force of fifty hundred men and landed at Tarrytown. At this point, under orders from Putnam, Colonel Ludington was stationed with five hundred men.

Clinton sent a flag of truce with a peremptory demand to surrender themselves as prisoners of war. While parleying with the flag, the enemy endeavored to surround the militia and effect their capture, but Colonel Ludington, perceiving the object of Clinton, ordered a retreat and withdrew to a place of safety. The British then withdrew.

Colonel Ludington's report of this

Anecdotes of Colonel Ludington—Born in 1739

affair to General Putnam was made during the afternoon of the fourth of October, and after detailing the conditions in the vicinity and describing the arrival, landing and force of the British in this undertaking, he reported:

That under command of Governor Tryon, they immediately took the heights above Tarrytown, and from thence kept the heights until they thought they had got above our little party, but luckily we had got above them and paused at Mr. Young's, where we thought best to move towards them, where we were in open view of them, and found them to be vastly superior to us in numbers, and moved off to Wright's Mills. Having no assistance more than our little party belonging to our regiment, I found on our retreat, before we got back to Young's, they had sent forward a flag, but found it was in view of trapping us, as they had flanking parties, who we discovered, in order to surround us, but after clearing the regiment, I rode back and met the flag within a quarter of a mile of their main body. The purport of his errand was that Governor Tryon had sent him to acquaint me, if we would give up our arms and submit, they would show us mercy or otherways, they were determined to take us and strip the country. Sent in answer: That as long as I had a man alive, I was determined to oppose them and they might come on as soon as they pleased. We have not lost a man and the last move of the enemy was from Young's towards the Plains.

The exigencies of the situation brought Colonel Ludington into services other than the purely military. The Continental Army had purchased large supplies of grain and hay in Eastern Dutchess County, New York, and Western Connecticut. In order to transport it rapidly and to otherwise facilitate the movement of these supplies, it became necessary to improve the roads. William Duer on behalf of General Mifflin, the Quartermaster General of the Continental Army, informed the committee that it was necessary that the roads toward North Castle and Rize's Ridge in New York should be repaired. The committee, acting promptly on this matter, ordered the repairs to be made and directed that Colonel Ludington should detach one hundred men from

his command and assign them to this duty. It was also important that the roads and bridges should be in good condition on account of the movements of the British from the northward. Washington also had these matters under his personal attention, and to meet any emergency that might arise, he ordered three brigades of troops into the Fredericksburgh precinct. On their march these troops encamped on the meadow near Colonel Ludington's house and remained over night.

While Washington was in the Fredericksburgh precinct in 1778, he was on several occasions a guest at the house of Colonel Ludington and once in the company of Count Rochambeau. Other distinguished men of the period enjoyed the hospitality of Colonel Ludington. Among these were William Ellery, a member of Congress from Massachusetts, who on the twentieth day of October mounted his horse at Dighton, proposing to ride to York, Pennsylvania, five hundred miles distant, where he was to resume his congressional duties. He was accompanied by Francis Dana and his servant. A sketch of his trip has been preserved, relating the incidents of his journey. On the fifth of November they left Litchfield, Connecticut, intending to reach Peekskill, but when they arrived at Danbury they were persuaded to abandon the route because of the Tories and horse thieves and the impossibility of reaching Peekskill that night. Unable to secure lodgings in Danbury, the Fishkill route was taken, and they reached the house of Colonel Ludington where they remained over night.

Ellery describes his experience at this place and the state of affairs in the immediate vicinity:

"Here, *mens meminisse horret*," we were told by our landlady that the Colonel had gone to New Windsor, that there was a guard on the road between Fishkill and Peekskill and one of the guard had been killed about 6 miles off, and that a man

The Secret Service of the American Revolution

not long before had been shot on the road to Fishkill not more than three miles from their house and a guard had been placed there for sometime past and had been dismissed only three days. We were in a doleful pickle, not a male in the house but Francis Dana and his man and William Ellery, and no lodging for the first and the last but in a lower room, without shutters to the windows or locks to the door. What was to be done? In the first place, we fortified our stomachs with beefsteak and strong drink (grogg) and then went to work to fortify ourselves against attack. Dana asked whether there were any guns in the house, two were produced. One of these in good order. Nails were fixed over the windows, the gun placed in the corner, a pistol under each of our pillows and the hanger against the bed-post. Thus accoutred and prepared at all points, our heroes went to bed. Whether Francis Dana slept William Ellery cannot say for he was so overcome with fatigue and his animal spirits with beef etc., that every trace of fear was utterly erased from his imagination and he slept soundly until morning without any interruption save that at midnight as he fancieth, he was awakened by his companion with the interesting question, delivered in a tremulous voice, "what noise is that?" He listened and soon discovered that the noise was occasioned by some rats gnawing the head of a bread cask. After satisfying the knight about the noise, he took his second and finishing nap. The next day it snowed and rained. We continued at Colonel Ludington's until afternoon, when the fire-wood being gone, we mounted and set off.

Colonel Ludington's residence was built prior to the Revolution and in style similar to almost every house of the period, two stories in front and one in the rear. Huge doors divided in the middle with ponderous latches gave entrance. The front was ornamented by a piazza, within large and spacious rooms, their ceilings low and the floors nicely sanded. Wide halls divided the rooms, a massive stairway led up to the commodious chambers. Immense chimneys rose within the structures, each with wide fire-places and large ovens. While many happy incidents are inseparately connected with this house, it possessed historic interest from its associations and for the many plans proposed and developed to bring success to the patriots' cause and arms. Its

good cheer to the way-faring man and the hospitality to its guests made it famous far and wide during the early period of the country's history. Long after its owners had passed from life, it was remembered by those who had been sheltered within its walls. It remained standing until 1838 when it was torn down.

Many places of trust and honor in civil life, both public and private, were held by Colonel Ludington. In 1772, he was the assessor of the Fredericksburgh precinct and was the supervisor in 1777-1778. He was a member of the legislature of New York, having been chosen for the third session, meeting at Kingston first, then at Albany, and closing its proceedings at its third meeting at Kingston, ending July second, 1780. He was also a member of the fourth session, meeting at Poughkeepsie, September seventh, 1780, and ending its second meeting at Albany, March thirty-first, 1781; and afterwards a member of the ninth session convening in New York, January twelfth, and adjourning May fifth, 1786. He was elected the fourth and last time as a member of the legislature for the tenth session, which body met in New York, January twelfth, and finished its labors April twenty-first, 1787. His votes are recorded with the majority vote. By a commission dated March twenty-sixth, 1804, he was appointed a justice-of-the-peace for the town of Frederick, Dutchess County. This office he held for many years and administered its duties with dignity. His equitable decisions, on common sense principles were seldom reversed. It is related of him by those who knew him intimately that when he was first appointed, and for several years thereafter, he had no law books and that he made his decisions without precedent, but they were almost invariably sustained by the higher courts. The idea of holding courts without the statutes was considered preposterous by his neighbors and at length he was prevailed upon to send to Poughkeep-

Anecdotes of Colonel Ludington—Born in 1739

sie to make a purchase of a set of books in order to make his decisions in accordance with the statutes. The books were purchased and judgment rendered, but it was not long before an appeal was taken and his decision was not upheld by the higher court. The reversal settled the question of books with him conclusively. From this time he laid them aside and declared he would never make another decision from them—and he did not.

Multifarious and constant as were his public and private duties, his interest in other affairs was not obscured nor lessened. When the first academy was erected in Patterson, Putnam County, New York, a school which obtained considerable importance during its time, he contributed the timber for its construction. He built and operated a saw and a grist mill,—the first one built in that section. It was erected during the Revolution and was known as the "Lud-dinton Mill." Its reputation gave it great custom and it enjoyed a unique reputation from the fact that the structure was raised almost solely by women, the men being absent in the military service of the country. The building is yet standing and with some alterations and improvements the wheels go merrily round as in the days of yore, but the old saw mill has long since passed out of existence, hardly a memory of it remaining.

Colonel Ludington in personal appearance was a man of commanding presence. He was above the medium

height, erect of figure, with prominent features and had blue eyes. His convictions were sincere and resolute. He was irreproachable in character and determined in purpose. His business capacity was evidenced by the successful manner by which he conducted his private affairs. The farm, the mills and the inn, while demanding a large share of his attention, did not prevent him giving thoughtful care towards the performance of his public duties.

Colonel Henry Ludington was the oldest son of William and Mary (Knowles) Ludington of Branford, Connecticut, where he was born May twenty-fifth, 1739. His ancestor, William Ludington and his wife Ellen were of English origin and settled in Charlestown, Massachusetts, about 1632, afterwards removing to New Haven about 1660, and it is recorded that he died at the East Haven Iron Works in 1663. His grandfather, William Ludington, was a prominent and an influential man among the New Haven colonists, both in church and political affairs. His parents were of the intelligent farmers of the New Haven Colony.

Colonel Ludington died January twenty-fourth, 1817. The end came suddenly—almost without warning. In the village churchyard adjacent to the Presbyterian church at Patterson, Putnam County, New York, lies his remains, suitably marked and where also are interred several members of his family.

HERITAGE OF YEARS—BY HOWARD ARNOLD WALTER

Swift phantom strokes, borne from a distant bell
Peal sweetly— as the shadowy clock of Time
Numbers the years in soft, melodious chime.
Truthful the tale their brazen voices tell
Of many summers spent, or ill or well,
Of sorrows mingling thick with joys sublime,
Angelo deeds with whisperings of crime,

And marriage music merged in funeral knell.
The time for preparation overpast,
Behold the heritage the years have given !
A vision broad, to view and understand,
A courage brave to face a work so vast,
A willing hand to lift earth nearer Heaven,
Broad mind, brave heart, and ever-ready hand.

William Pynchon—An Immigrant to the New World in 1630



An Oxford Graduate who Came to the Western Continent as an Indian Trader and Settled on the Trail & He Accumulated Wealth and Founded a Family which has Contributed Liberally to American Progress & Nathaniel Hawthorne's Controversy with the Pynchon Family over His Novel & Heirlooms of the Early American Pioneers & Described

BY

BLANCHE NICHOLS HILL

OF NEW YORK

WHEN America's greatest novelist, Nathaniel Hawthorne, wrote "The House of the Seven Gables" the Pynchon family protested against what they considered an unwarranted use of the family name in the story. One of the novelist's strongest characters was stern old Colonel Pyncheon—Hawthorne spelled the name with "e," but the Pynchon family invariably omitted it. Another of his characters was Hepzibah Pyncheon and her heroic, self-sacrificing love for her brother Clifford,—and there was little

Phoebe Pyncheon, the only illuminating ray in the decaying old house.

Hawthorne, when informed of the disfavor of the Pynchon family in being incorporated into his admirable picture of the dignified and austere Puritan period, made an apology. The family in its sense of dignified repose and propriety considered that the celebrity of the novel brought them into an undesired notoriety which to them was offensive.

The Pynchon family treasures among its heirlooms the letter of apology from the distinguished American novelist, and Hawthorne refers to the incident in a letter to his sister Louisa, dated Lenox, May 20, 1851:

HAWTHORNE'S TROUBLES EXPLAINED IN LETTER TO HIS SISTER

"How do you like 'The House of the Seven Gables?' Not so well as 'The Scarlet Letter,' I judge from your saying nothing about it. I receive very complimentary letters from poets and prozers, and adoring ones from young ladies; and I have almost a challenge from a gentleman who complains of my introducing his grandfather, Judge Pyncheon. It seems that there was really a Pyncheon family, formerly resident in Salem and one of them bore the title of Judge and was a Tory at the time of the Revolution,—with which facts I was entirely unacquainted. I pacified the gentleman by a letter."

William Pynchon—Immigrant to America, 1630

No apology was really necessary, Hawthorne having really written from his own experience rather than from his imagination, for in another letter he refers to the curse which, according to those who knew him best, oppressed and affected him, and was brought upon the family by Judge Hawthorne of Salem, the aforesaid malediction having been invoked by Rebekah Nurse, who was condemned to death by the judge in his official capacity. Matthew Maule was Hawthorne, and Phoebe was inspired by Hawthorne's wife. The episode of the Pyncheon deed, which was lost and restored after it was valueless, was suggested by similar facts in the Hawthorne history.

It is of this Pynchon family that I shall here relate: While doubtless there have been members of the Pynchon family, who with Yankee foresight, accumulated their share of this world's goods, they possessed another equally strong New England characteristic, for the American branch of the Pynchon family has been more or less identified with the intellectual and scholastic life of the country rather than with the commercial world, as the Hawthorne view implied, the English members claiming Oxford for their *Alma Mater* and the American Pynchons matriculating at Harvard, Trinity or Yale.

The name is one of the oldest in England and as far back as 1277-8, in the sixth year of King Edward First, Richard Pinchon, a citizen of London, bequeaths his property to his daughter Agnes. Many of these old wills are very quaint. That of Nichas Pynchon, citizen and "bocker" of London, indicates that he was a devout believer, for he says, February 15, 1528: "I bequeath and recommend my soul unto Almighty God, my maker and my redeemer and to the most glorious Virgin his mother, our lady Saint Mary, and to all 'tholy and Blissid company of Saintes in hevyn.'" After carefully providing

for his family and his church, he leaves among other charities "ten pounds to be applied in buying coals in the Winter season, in ten years next after my decease, to be distributed amongst the most needy poor of St. Nichas."

Another member of the same family, Wyllyam Pynchon, bequeaths "twenty shirts and twenty smocks and forty bushels of wheat to be given and divided amongst the poor folk in Writtle and Roxwell, and that the same may be done by the church wardens and two or three honest men of the parish," thus in his last moments showing a shrewd estimate of frail human nature.

A common legacy in those wills were rings of remembrance, often "of gold of weight of 40 shillings," or "of the weight of 3 pounds 5 shillings and 8 pence," and the scale varies in different wills according to the degree of friendship or obligation. In many, "a black cloak" or "a black gown" is bequeathed, that the beneficiary may show that proper respect for the dead that still has such a firm hold on English customs.

Wyllyam Pynchon was buried at Writtle, and the chancel of the beautiful little church there is nearly filled with the monuments and memorial tablets of the Pynchon family. In the church in Springfield, England, not far from Writtle, there is a tablet on the wall of the vestry room with the name of William Pynchon inscribed on it as one of the church wardens, dated 1624. This is the William Pynchon who was one of the original patentees of the Massachusetts Bay Colony, and who six years later assisted in bringing that charter to America. He was educated at Oxford, matriculating at Hart Hall, afterwards Hertford College, October 14, 1596, when he was but eleven years old. It was in 1630 that he brought over the charter in a fleet of three vessels. In the same year he founded Roxbury and six years later Spring-

Founder of the Pynchon Family in America

field, Massachusetts. This last named was on the direct Indian trail leading from the Narragansett and Pequot country by way of the Westfield River to the Mohawk country above Albany, so that parties of Indians were constantly passing his door in every direction. He accumulated wealth by trading, and Warehouse Point, Connecticut, just below Springfield, received its name from John Pynchon's warehouse situated there. So great was William Pynchon's influence among the Indians of the West as those of New England, that the Mohawks used to call New Englanders "Pynchon's men."

He also indulged in the literary bent of the family, publishing a book entitled, "The Meritorious Price of Our Redemption," which being anti-Calvinistic in its views so stirred up the colony that the book was ordered to be burned and the author cited to appear before the general court. After being summoned to court a second time, he left the colony in September, 1652, and returned to England. Two copies of this work are extant. One is at the Lenox library and the other is owned by the present head of the family. His only son, John Pynchon, remained in New England, and from him are descended all who bear the name in America.

One of the most illustrious of his descendants was Rev. Thomas Ruggles Pynchon, who from 1874 to 1883 was president of Trinity College and was a most potent agent in extending the influence of the college as well as adding more buildings. But from the time he entered college as a student until his death in October, 1904, he was closely identified with the work and power of that institution. He was ordained at Trinity Church, Boston, and from 1849 to 1855 had charge of churches in Stockbridge and Lenox, Massachusetts. He held the degree of D.D. from Stevens College, and LL.D. from Columbia. After his death a large part of the old family

possessions came into the hands of their present owner, the eighth in descent from William Pynchon, the founder of the American branch of the family.

Most of the furniture is very old and of that severely plain and massive type so long associated with our Puritan ancestors. Exquisite housekeepers were those female members of the family, for few marks of time mar the softly glowing mahogany. One of the most interesting pieces is a clothes press with deep shelves behind two large single-paneled doors. Below are three drawers, with brass handles, the design showing a lion's head with a ring in his mouth. A similar "Cloaths Prefs" but with another style of feet, is shown in the book of Thomas Chippendale, who thus naively expresses himself on the title page:

"The gentleman and cabinet maker's director: Being a large collection of the most elegant and useful designs of household furniture in the most fashionable taste."

The mahogany bed is handsomely carved at the corners of the head and foot boards, just enough for ornament but not enough to mar the beautiful grain of the wood. A plain massive bureau of the same red mahogany and with severely plain wooden knobs, is filled to bursting with hand-woven linen. There are huge linen sheets and pillow slips, with knitted linen lace. There are bedquilts and testers and curtains, and a beautiful hand-made tufted spread, woven double, with the pattern picked up on the right side, the design being a six-pointed star in the center with a Greek key pattern around the edge above the twisted fringe. The latter bears in precise cross-stitch the initials of Alicia Van Epps Murdoch, a daughter of Mistress Murdoch, through whom the Pynchon's became allied to the Hales. For she had two daughters, one of whom married William Henry Ruggles Pynchon, of Connecticut, and the other Dr. Enoch Hale, of Boston, who

William Pynchon—Immigrant to America, 1630

was an uncle of Edward Everett Hale and a nephew of the young patriot, Nathan Hale.

There is her portrait, framed in a band of dull gold. What a sweet strong face it is under the white cap and framed by the folds of the white shawl, with its narrow border, a gay note of bright cherry relieving the demure Quakerish effect of the costume. Ah, Polly Miller, more than your pointed bowl silver spoons, marked with flamboyant capitals, and your patiently woven linen sheets and baby garments, filmy and fine enough for a royal infant, is the legacy of the character you left behind you and which reflects itself in those who revere your memory.

There is another quaint bed, a "bachelor bed," as they called single beds in those days. It has four slender posts and is the prized possession of the little daughter of the family. Whether pride of race is dormant in children at an early age, no one can tell, but she is very proud of the little bed. Environment plays its part in the development of children and the practical methods of modern life appeal to her just as strongly, even though she be but six years old. For example, when taken recently to visit a grand-aunt, whose home has no modern innovations, and at bed-time her mother told her to mount the steps to get into the huge four-poster bed, with its well-shaken feather-bed, she objected, wailing:

"Oh, mama, I don't want to sleep on a big fat stomach."

So her little bed has been fitted with a modern spring and mattress.

One of the most attractive pieces of furniture is the old mahogany desk that for many years was used by Dr. Enoch Hale in his office in Boston and later was used by President Pynchon at Trinity. If it could speak, what a host of memories the solid, substantial, respectable piece of wood could give forth. It has the indescribable velvety look that only the cabinet-fin-

isher, Time, can give to mahogany. The Hales have always been college bred and with literary proclivities no matter what profession they followed. Enoch's father was the first minister of Westhampton, and his uncle Nathan, the father of Edward Everett Hale, was a journalist. Enoch was educated at Harvard but decided to minister to bodies instead of souls. In spite of the demands made on the busy physician, he found time to write various pamphlets and treatises relative to his profession. In view of the recent conflicting opinions among medical authorities regarding the cause and cure of cerebro-spinal meningitis, it is interesting to note that one of the earliest of these pamphlets, published when he was but twenty-four years old and in the first year of his practice, is called "The History and Description of the Spotted Fever, Which Prevalled in Gardiner, Maine, in 1814." And after nearly an hundred years, the problem has not even yet been satisfactorily solved.

On the left side of the desk is an octagonal mat worked by Enoch Hale's wife. It is in cross-stitch in wool and silk. The greens and blues are softened by age. It serves as a mat for a quaint urn-shaped inkwell of dull bronze, exquisitely modeled in detail, with places for quill pens and a tiny seal. Another inkstand of the same dull bronze is more modern in appearance, with its inkwell at either end and a tray for pens, but it was evidently in use long before envelopes were employed, for the center space is occupied by a small candlestick, the tiny snuffer hanging by a wire hook through a hole in the side of the candlestick, to snuff the candle when the wax had been melted and the missive sealed. A rack for letters or papers of the same bronze is an artistic design formed of a branching spray of holly.

There are two Davenport, and nine open, low-backed chairs, upholstered in haircloth. These are asso-



Oak Cradle made about 1660 and imported to America from an old Worcestershire manor house—It has incised panels and borders, with a panel hood at the head—The rockers are curved at the tops and are held in the very ends of the corner posts—The cushions inside are covered with figured vellet—This photograph is from the original cradle and was taken for Miss Esther Singleton's volume on "The Furniture of Our Forefathers" and here presented by courtesy of Doubleday, Page and Company of New York

Founder of the Pyncheon Family in America

ciated particularly with the home of Thomas Pyncheon, in whose parlor they stood for many years.

There is a graceful Hepplewhite table, with folded top and slender legs inlaid with a beautiful pattern in satinwood. The old sideboard is massive and plain, following the general style of the desk and clothes press. Furniture was built for use in the early struggling days of the colonies. But only great care and careful handling could have preserved the wine and spirit glasses, the heavy goblets, the slender decanters and the exquisite china. One member of the family owns a complete set of old blue and white Canton china, of that dull soft blue that is so beloved by collectors and is valued at \$1,500. But if collectors should ever have an opportunity to bid for it, which is unlikely, there is no knowing to what high figures it would go.

Quite in contrast to the highly polished glass is a pitcher, which will belong to the ninth generation of Pyncheons, coming through the mother's side of the family. It is especially interesting for it is a piece of the first glass made in the colonies. But whether it all came from Jamestown in 1607 or came from the factory in Salem, Massachusetts, which was started in 1629, no one knows. But it is very old and the edges of the handle are rough and the glass is crude indeed when placed beside two beautiful fruit dishes, one high and one low, of the old English cut glass. The edges of these are scalloped and an engraved pattern of grape leaves makes the high polish of the plain portion but shine the more.

There is old china, curious pitchers of graceful shape, bits of pewter and old plate. There was a plate-warmer of china, with two handles and made exactly like a pewter one that came from the Cogswell family, another of historic prominence, but it has become broken or lost. There is an interesting story connected with the pewter

one. It was kept for one member of the family who was always late to meals. What an intimate view that chance phrase gives of the mother of the household—tender and indulgent and with a proper pride that her culinary art should not be spoiled by the laggard. But imagination can only finish out the picture and whether the late-comer was the staid and dignified head of the family, busied with many cares, or a handsome lad with impetuous way, full of the many interests and subject to the allurements that appeal to us when we are young, or a little beauty who had but to smile and the rest of the family obeyed her bidding, no record remains.

Even some of the children's playthings have been preserved. There is a much worn miniature bed with four posts. It is almost gone now, but no wonder, considering how many generations of young mothers have put their dollies to bed in it. Speaking of dolls, there are two treasured carefully for many years. Both are very small and made of wood, their features carved and painted. One of them is brave in a frock of buff cotton with pantalets of the same, and her muttonleg sleeves shirred at the inner arm would serve as a model for the present mode. The paint on her cheeks is still fresh and her carved comb is a good imitation of shell. The other doll is an inch taller and represents a bride. Her veil, falling over her modest face is hanging in shreds and tatters, and the sight brings sadness, so emblematic is it of life and those other brides whose heart illusions have faded away long before their veils had lost their pristine freshness.

There are heavy curtains of curious colors. There is an old blue and white Staffordshire washbowl and pitcher. There is a curious brazier and a low silver candlestick with carved ornament around the edge, and the handle is twisted into a graceful curve, and many other quaint and in-

William Pynchon—Immigrant to America, 1630

teresting objects, each with its hidden history and clustering memories.

There are old books and old letters and papers which have come down through the centuries. Among them is a letter from William Pynchon to Governor Winthrop, bearing the endorsement of the latter. A piece is torn from the blank space of the last page and tradition has it that the governor with true Yankee thrift, saved the scrap for future use. Paper was a valuable commodity in the early days of the Massachusetts Bay Colony. The original seal of the family is not in existence, but there are several old seals of later date.

Among his other classmates were Sylvanus Griswold of Lyme; Daniel Humphreys, G. S. Hobart, judge of the United States District Court and United States Senator from New York; Sir Edmund Fanning, lieutenant-governor of Nova Scotia and governor of Prince Edward's Island; Rev. Dr. Abraham Beach; Rev. James Scovill; Rev. Samuel A. Peters. Joseph Pynchon's name stands sixth on the roll of the class, of which the membership was forty.

He married Sarah Ruggles, the only child of Rev. Thomas and Re-

NEW HAVEN, Sept. 2, 1757.

DEAR SIR:

Yesterday I arrived at Old Yale; find all things in good order; all things prepared for commencement, except gowning, which we are at a loss where to get. Therefore, if you light on any at Guilford should be glad if you would engage it, and send word as soon as possible.

Sir, we are all well, and want nothing but your good company, which we all insist on having this week or the beginning of the next at the farthest. We are in great expectations that the commencement will be private, and that it will be on Friday or Saturday of next week—the reason of this conjecture is considerably from the president's proposing to give all liberty to go home on next Saturday that shall make application to him or the Tutors therefor. Pray, Sir, direct a letter to Sir Griswold, engaging him to call you in his way to New Haven, on the beginning of the next week. If you want the opportunity, pray come yourself without fail. Please excuse the incongruity of this epistle since it comes from one whose mind is continually harassed and perplexed with the thought of the inevitable ruin and destruction that is impending and just at hand upon himself and country. Give proper regards to all friends, from your ever sincere

& affectionate friend & servant,

JOSEPH PYNCHON.

P. S. Chandler & Prynde send compliments.

Another branch of the family includes the Gilmans, also among the foremost in the educational life of the country.

Among the many interesting letters that are yellowed with time, folded with precision, and fastened with seals, is one written by Joseph Pynchon, great-great-grandson of William Pynchon of Springfield, Massachusetts, to his classmate Nathaniel Caldwell of Guilford, Connecticut, in 1757, from New Haven, where he was awaiting the Yale College commencement of that year.

Lecca Ruggles, the minister of Guilford, Connecticut. He was a loyalist, and passed the whole period of the Revolutionary War in the city of New York. At the close of the war in 1782-3 he became the leader of the famous Loyalist emigration to Nova Scotia. He returned to Connecticut in 1784 and died at Guilford, November 23, 1794.

There is a letter of Madame Pynchon of Springfield, Massachusetts, written to her son at Cambridge, and his reply, both of which are characteristic of mothers and sons of every period.

Founder of the Pyncheon Family in America

SPRINGFIELD, June 26, 1743.

Dear Son Billy, having but a few minutes just to inform you of our welfare and our friends. I have not heard from you since you first went down. Would be glad to hear of your circumstances. I have just sent by Capt. Colton a pair of yarn stockings, which would sent 6 weeks sooner if I had opportunity. Hope now will come safe. Would just inform you that Cos. Charles Wimick departed this life yesterday was 6 months sick. Give my dear Regards to all friends at Cambrldge & Boston. Brothers and sisters send their love. Accept of mine from your loving mother,

KATHERINE PYNCHON.

This lady was the daughter of Rev. David Brown of Springfield and at this time was a widow.

We know that Captain Colton delivered the yarn stockings and the letter safely to "Mr. William Pynchon in Cambridge." for this is his reply:

"These must all be kept for the children," she said. "Some one of them will care for and appreciate them."

Which will it be? The eldest son of the family, who at present is as full of pranks and falls into as many ex-

Honored Madam

July 18, 1743.

I believe I shall not come home by water, but have determined unless some very convenient opportunity happens so that I can ride up by horse, to tarry here the vacancy. Madam Larrabee, and m Betty is indisposed, very much, and the Capt. also. I invited them up to Comt but they not being able to come I saved my money and credit too. I am in health, have gained flesh I find since I came down, have nothing now to tell you off

But am your dutiful son WILLIAM PYNCHON JR.

Human nature is the same in all generations and in spite of the stately form of expression this is just like the letters of hundreds of college lads the land over.

Fortunately all these interesting possessions have fallen into a home where they will be cherished. A neighbor who had seen the wonderful linen and testers suggested what beautiful frocks they would make for the children. The mother of the rising generation of young Pynchons was aghast.

citing escapades as a healthy nine-year-old is capable; or the little lady with brown curls, who loves her great-grandfather's bachelor bed; or her younger sister, too young to appreciate anything but the quaint wooden dolls; or the chubby baby whose crib lies so close to the old carved bed that his fat toes may touch its sacred wood? However it be, fortunate it is that these heirlooms are cherished, not for their value in the antique mart, but for the memories they bring of maids and men who lived in days that are no more.



Book Plate of Reverend Thomas Ruggles Pynchon
President of Trinity College, Hartford, Connecticut
Descendant of William Pynchon, 1630

Progeny of Saxon Kings in America

Unbroken Line
of Descent from Egbert
the First Monarch of all England in the
Year Eight Hundred to William Tracy of Hayles Abbey who
came to America in 1620 and Invested His Entire Fortune in Virginia &
Tragedy of one of the First Promoters in the New World & Lineage Established

BY

DWIGHT TRACY, M.D., D.D.S.

CAMBRIDGE, MASSACHUSETTS

NEW YORK GENEALOGICAL AND BIOGRAPHICAL SOCIETY — NEW ENGLAND HISTORIC GENEALOGICAL SOCIETY
MEMBER OF THE SONS OF AMERICAN REVOLUTION

THIS is the tragedy of a scion of one of the noblest families of Europe, who, reared in an ancient palace and inheriting one of the oldest estates, became imbued with the spirit of the New World, invested his property in vast tracts of its savage lands, came to America to enter into its development, lost his entire fortune and died broken-hearted.

It is the story of a man's faith in the ultimate greatness of the Western Continent; his belief that it would arise as one of the world's richest domains—a confidence in its future that led him to abandon a life of Old World luxury and ease to cast his lot against fate on the unknown hemisphere. As far as his knowledge of it is concerned his conjectures were wrong. The realization of his dreams never came to him in his brief day. He lived only to see his visions dissipated, to find his dreams were mirages, to discover that the soil on which he stood was a quicksand that carried him to misfortune.

This is one of the anomalies of history. In the very moment of failure the embryo of success was unfolding—a success so full, so prodigal, so stupendous that more than a million of the peoples of the earth are coming in annual pilgrimages to partake of its abundance.

This son of the Saxon kings was right! His prophetic visions were all too true. From his own financial ruins has risen a great nation and a great race to which he contributed Saxon energy, Saxon indomitability, Saxon valor, Saxon integrity. His loss was gain; his failure was triumph.

While this heroic sacrifice lends romance to the drama of American history, its real significance is in the proof that the best blood of the Old World was interested and actively engaged in laying the foundation upon which the greatest Republic of the earth has been built. It is of especial interest on this occasion of the tercentenary of the first permanent English settlement in America as it is at this shrine that its first scenes were enacted. As a contribution to the literature of the exposition it is of much value.

The discoveries herein related are of so real import to American genealogical literature that brochures have been prepared for public libraries and private distribution by the author. Dr. Tracy in a letter preliminary to its publication says: "In my investigations I have not found a town under the American flag on this continent but has descendants of this Saxon blood. I have found it in far-away Australia and Honolulu, and have traced it into most of the civilized countries."

The Progeny of Saxon Monarchs in America



ANCIENT OLD WORLD MANOR OF THE FIRST TRACYS IN AMERICA

Exhibit 1—The birthplace of William Tracy who came to Virginia in 1620—At the time of the Domesday Survey it was occupied by the great-grandson of King Ethelred—Print from rare engraving in 1712 when the estate was in possession of William Tracy, a cousin of the William Tracy who had come to America ninety-two years before

SOME years ago I heard the tradition that the ancient Tracys in America were of royal descent; that the blood in the veins of these first American settlers was that of the old Saxon kings. During my long life I have listened to countless narratives pertaining to the Tracys, and for a generation I have given heed to them all and have followed every clue to its minutest detail.

It is a matter of much import and

its revelations are vital to the entire American people, for it is in the secrecy of the home that all real history is begun. Only through the study of the family groups can be traced the development of great deeds or the evolution of government. The power behind the throne in all nations is the family circle which is molding the character of its citizenship and marking the path for its future.

One of the earliest traditions that came to me was that the Lieutenant Thomas Tracy, who appears first in the records of Salem, Massachusetts,

Unbroken Line of Descent from King Egbert

in 1636-7, and died at Norwich, Connecticut, on November 7, 1685, was of noble birth and that his ancestors lived on the Toddington estate in Gloucestershire, England. Although this tradition was wholly unsupported by evidence, I took up the clue and began a systematic research. I found it frequently stated that Thomas Tracy was the pioneer of the Tracy family in America, but early discoveries led me to believe that his father came with him to the New World.

After thirteen years of continuous investigation, during which I have devoted my entire labors to establish the Tracy lineage, I am here prepared to state that the Tracys are of royal descent and that their blood is one of the noblest strains of the Old World.

I shall here lay before you my proof—not mere inferences but genealogical evidence supported by exact transcripts and facsimiles from ancient records and documents. As my

investigations completely upset the voluminous genealogical dicta regarding the Tracys in England, and wholly disagree with the mass of material that has been collected and published on the subject, I realize the necessity of establishing my contention beyond doubt. This I shall do with photographs of original letters, documentary proof from official records, corroborated by sundry testimonies from authoritative sources, establishing the genealogical fact that the aforementioned Thomas Tracy who died at Norwich, Connecticut, was born in Gloucestershire, England; that he was the son of William Tracy, esquire, of Hayles Abbey, and his wife Mary Conway of Arrow, Warwickshire; that this William Tracy was the third son of Sir John Tracy, the knight of Toddington castle, and his wife Anne Throckmorton. With this established, the line runs back in unbroken succession to Egbert, the first Saxon king of all England.



TODDINGTON IN 1830—NEARLY FIVE HUNDRED YEARS THE SEAT OF THE TRACYS

Le Sire de Traci, a Norman Baron, went to England with William the Conqueror and fought in the Battle of Hastings in 1066—His granddaughter, Grace de Traci, married Lord Sudeley, John de Maigne, son of the Lord of Toddington, connected with the royal line of Saxon kings—Rare print from an engraving made in 1840 in London

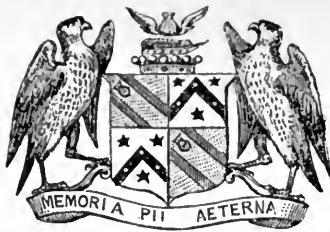

A THOUSAND YEARS OF LINEAGE FROM SAXON KINGS

Connecting with the Tracys in America through William Tracy of Virginia in 1620 and Thomas Tracy of Massachusetts and Connecticut in 1636

1. Egbert, first King of all England, reigned 800-838, his son
2. Ethelwolf, 839-854, his fourth son
3. Alfred the Great, 871-901, his second son
4. Edward the Elder, 901-925, his second son
5. Edmund I, 941-946, his second
6. Edgar, 951-975, his first son by second wife
7. Ethelred, 978-1015, his youngest daughter Princess
8. Goda, married first Walter de Maigne, (de Medantine, de Mantese, etc.) a Norman Nobleman.
9. Rudolph de Maigne, Earl of Hereford.
10. Harold de Maigne, Lord of Sudeley and Toddington.
11. John de Maigne, Lord Sudeley, married Grace de Traci, dau. of Henry de Traci, feudal Lord of Barnstaple and grandau. of Le Sire de Traci a Norman Baron who went to England with William the Conqueror and was in the battle of Hastings, 1066: his name is in the roll of Battle Abbey.
12. Sir William de Traci, son of aforementioned John de Maigne and Grace de Traci, who assumed his mother's name of Traci; High Sheriff, 1269; Knight, 1289.
13. Sir William de Traci, High Sheriff, 1319.
14. Sir Henry de Tracy.
15. Sir Henry de Tracy.
16. Sir John Tracy, High Sheriff, 1359 to 1362.
17. Sir John Tracy, High Sheriff, 1363-8-70; Knight of the Shire, 32-37-40-and 43 of Edward III.
18. Henry Tracy, Esquire.
19. Sir John Tracy, High Sheriff, 1379.
20. Sir William Tracy, High Sheriff, 1416; m. Alice de la Spine.
21. Sir William Tracy, High Sheriff, 1442-3.
22. Sir William Tracy, High Sheriff, died ante 21 Henry VII, High Sheriff 1513, m. Margery Pauncefort 1449.
23. Sir Henry Tracy, High Sheriff, m. Alice Baldington.
24. Sir William Tracy, Knight, m. Margaret Throckmorton.
25. Sir William Tracy, m. Agnes Digby.
26. Sir Henry Tracy, m. Elizabeth Bridges. Will proved Sept., 1557.
27. Sir John Tracy, Knight, m. Anne Throckmorton. Knighted 1574.
28. Gov. William Tracy, of Hayles Abbey m. Mary Conway. He qualifies for the Societies of Americans of Royal Descent and Colonial Governors. Immigrated to Virginia in 1620.
29. Lt. Thomas Tracy, of Massachusetts and Connecticut, m. three times. Children all by first wife, whose name is unknown.

From this progenitor is infused the blood of the Saxon Kings into the American Race—Its descendants are scattered throughout the Nation and the world — Nearly every English-speaking municipality in the United States has this Saxon blood in its composite citizenship — It has been traced from America to the Orient, to Australia and Honolulu, and to most of the civilized countries, and has built a strong race of men

Unbroken Line of Descent from King Egbert

In proof of the unbroken chain from Egbert, the first Saxon king, down twenty-eight generations to William Tracy (28) of Hayles Abbey, who married Mary, the daughter of Sir John Conway, of Arrow, County of Warwick, sister of Lord Conway, I present a photographic reproduction of the two pages from Britton's Toddington, published in 1840, and an English authority. In investigating these lines I find that the gene-

alogists have disagreed on certain points; but the main contention is so well established that these exhibits are conclusive proof. (Exhibits 2 and 3.)

The Tracy lineage, as given by former genealogists of the family, was substantially correct, down to the children of Sir William Tracy, Knight (24), who married Margaret Throckmorton. They (the genealogists), assumed that the line from this Sir William (24) was through his

THE TODDINGTON, OR TRACY FAMILY, is descended, on the paternal side, from Ethelred, whose daughter, Goda, married Walter, Earl of Mauntz, a noble Norman. From this marriage came Ralph, who was created Earl of Hereford by his uncle, Edward the Confessor. Harold, son of Ralph, married Maud, daughter of Hugh Lupus, Earl of Chester, and nephew to William the Conqueror. This Harold, who settled at Sudeley and Toddington, had two sons, Ralph and John; the latter of whom married Grace, daughter of William de Traci, natural son of King Henry the First. Their offspring were Ralph and William; the last assumed his mother's name of TRACY, and retained the family arms of Sudeley, with an escalop-shell for difference.

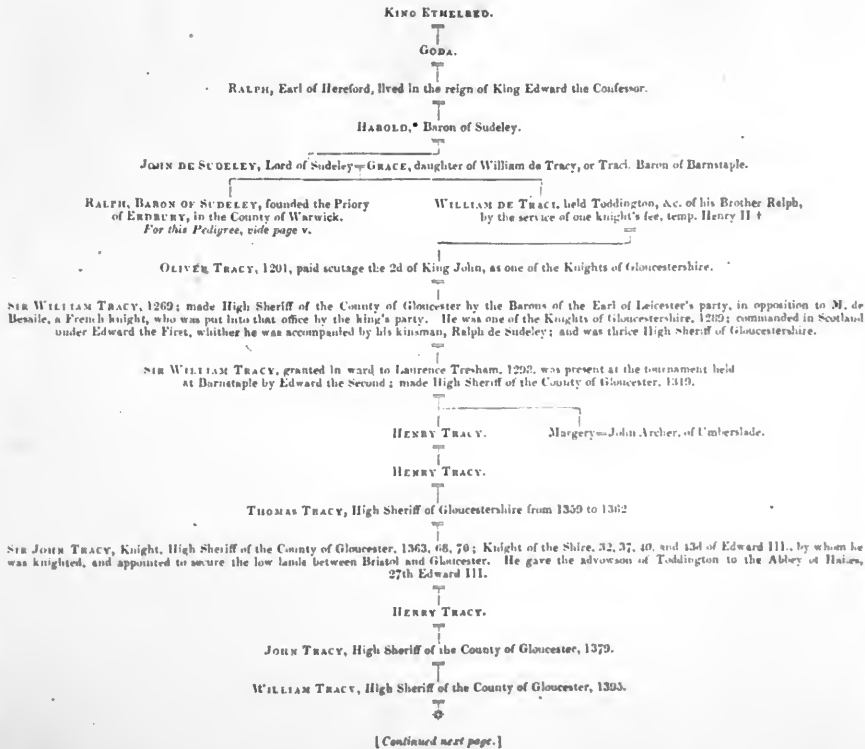

* At the time of the Conqueror's survey, Harold, son to Ralph, Earl of Hereford (who in King Edward the Confessor's days suffered the Welsh to enter that city, and destroy it by fire), being possessed of the Lordship of Buckhamton, in Berkshire; while, in Worcestershire; Tetelmarke and Dereton, in Warwickshire; de shof of Sudeley and Toddington, in Gloucestershire, had his chief seat at Sudeley; and afterwards

obtaining Ewyas, in Herefordshire, founded there a little priory for monks of St. Benedict's order.—Owen's History, vol. 1, p. 428.
† The Wm. de Tracy, with Fitzcarr, Morvile, and Brin, murdered Becket on the 30th December, 1170, at Canterbury.

LINEAGE OF THE TRACYS IN ENGLAND FROM ROYAL LINE OF SAXON KINGS
Exhibit 2—Photographic Reproduction from Genealogical Chart by J. Britton of London in 1840

The Progeny of Saxon Monarchs in America

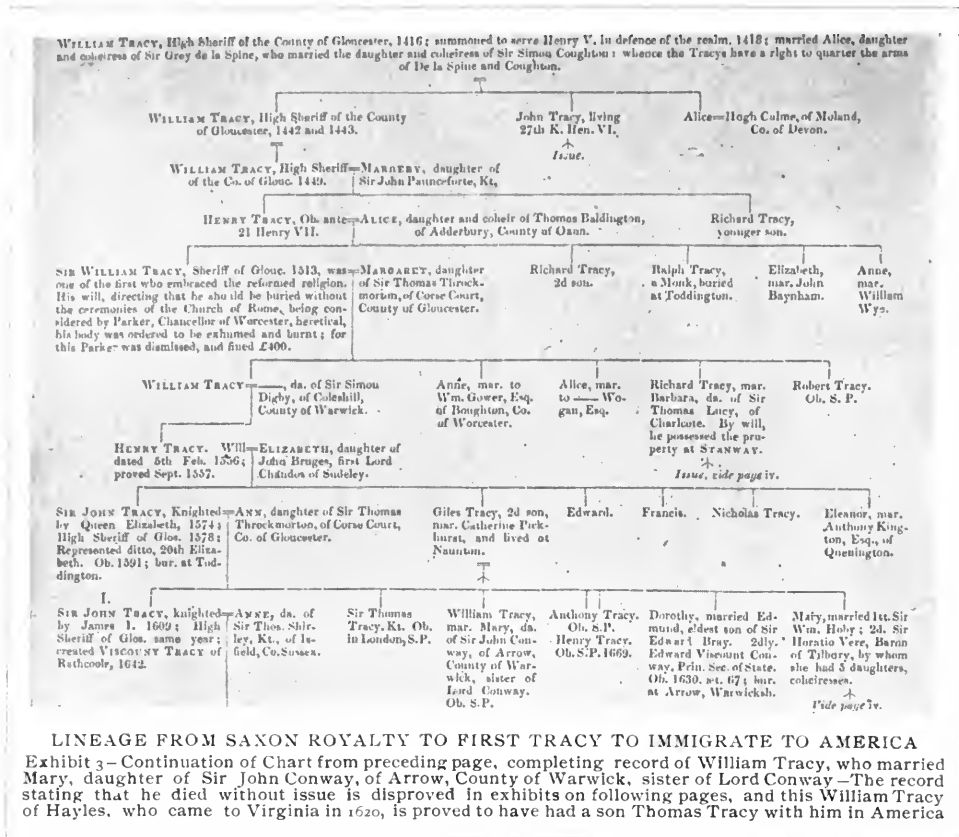

LINEAGE FROM SAXON ROYALTY TO FIRST TRACY TO IMMIGRATE TO AMERICA

Exhibit 3—Continuation of Chart from preceding page, completing record of William Tracy, who married Mary, daughter of Sir John Conway, of Arrow, County of Warwick, sister of Lord Conway—The record stating that he died without issue is disproved in exhibits on following pages, and this William Tracy of Hayles, who came to Virginia in 1620, is proved to have had a son Thomas Tracy with him in America

third son Richard, down to a Thomas; and that this Thomas was the Thomas Tracy who was on record, first in Salem, Massachusetts, 1636-7, etc.

My discoveries *prove* that the line continued from this Sir William (24), not through Richard, but through his (Richard's) eldest brother, Sir William (25), the heir to the Toddington and Sudeley estates; and so on down through the eldest sons to William Tracy, Esquire (28), the third son of Sir John Tracy, Knight (27), who married Anne Throckmorton; and that this William Tracy (28) came to Virginia September, 1620, in the ship "Supply" with his young son Thomas (29), etc., where he was a Councillor of State and Governor of Berkeley Colony or Hundred. He arrived in Vir-

ginia, before the Pilgrims landed in Plymouth.

This line, from Sir William Tracy, Knight (24), down to Lieutenant Thomas (29) of Norwich, Connecticut, constitutes the "missing link" in the line which has been so long sought, and which completes the pedigree chain, and indissolubly connects the descendants in America of this Governor William Tracy (28) and his only son Thomas (29), later Lieutenant in Norwich, Connecticut, with their Royal ancestors, the SAXON KINGS OF ENGLAND.

Britton, in his Toddington chart, in the account of the children of Sir John Tracy, Knight, (No. 27 in this paper) records that William Tracy (28) (brother of Sir Thomas Tracy, Knight) married Mary Conway, etc., and died s. p., that is, without issue.

Unbroken Line of Descent from King Egbert

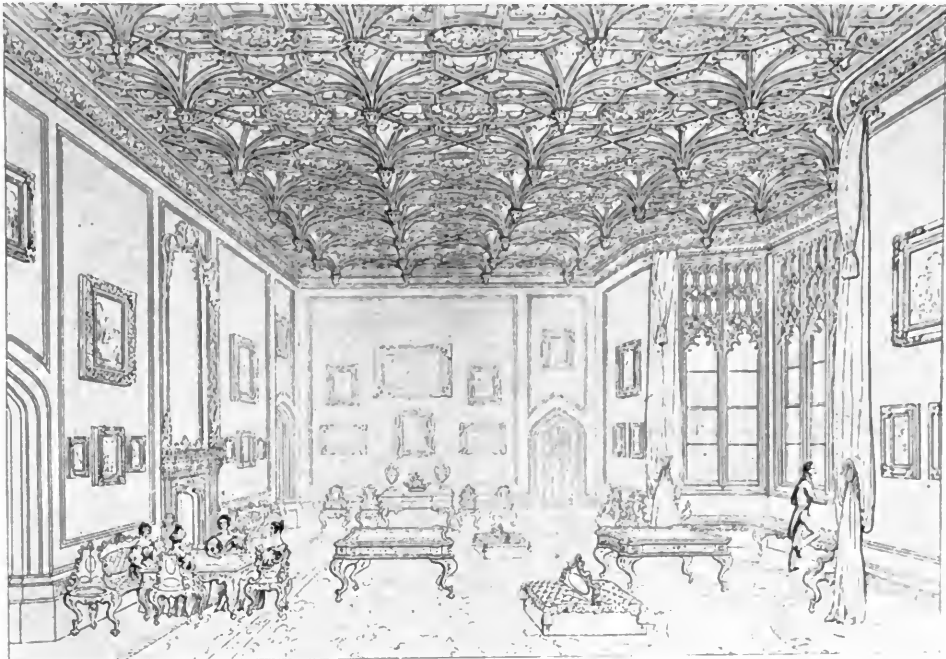

RICH DRAWING ROOM IN ANCIENT TODDINGTON—THE HOUSE OF THE TRACYS
Print from engraving made in 1840 when the estate was in possession of Lord Sudeley who was Charles Hanbury Tracy, descendant of the ancient Saxon Rulers

This "without issue" statement is proved to be an error by the records of the Virginia Company (Exhibit 7) which show that the William Tracy (28) who went to Virginia in 1620 was a brother of Sir Thomas Tracy, Knight (Exhibit 11) and that he took with him in the ship "Supply" his wife Mary, daughter Joyce and son Thomas (29) and this Toddington chart of Britton's shows that the parents of these two brothers—Sir Thomas, Knight, and William (28) who married Mary Conway, etc., were Sir John Tracy, Knight, and Anne Throckmorton his wife.

William Tracy, Esquire, (28) was born in the Toddington Manor-house, where his ancestors had lived for more than four hundred years.

Sir Robert Atkyns, in his history of Gloucestershire written in 1712, gives the following interesting account of Toddington, on page 409

and a picture of the Manor-house, as it was in 1712 (See Exhibit 1):

This parish lies in the lower part of Kiftsgate hundred, six miles distant north-east from Tewksbury, four miles north from Winchcourt, and fourteen miles north-east from Gloucester. Earl Randulfe held Todintun in the reign of King William the Conqueror, his son held it in the same reign. It was taxed at ten hides; there were twenty-one plow-tillages, whereof three were in demean; there were two water-mills, and fifty measures of salt belonging to the manor. This together with the manor of Sudeley, paid a yearly rent of 40l (pounds) in King Edward's reign. The manor of Toddington, at the Norman conquest was held of the manor of Sudeley. The abbe of Tewksbury had a grant of Court-leet, waifs and felons goods, in the reign of King William the Second, and their grant was allowed in a writ of *Quo Warranto* brought against them 15 Ed. I.

The family of the Tracys have been very anciently lords of this manor, and is descended from the blood royal of the Saxon kings of England. Ethelred, son of King Edgar, obtained the crown of England at

The Progeny of Saxon Monarchs in America

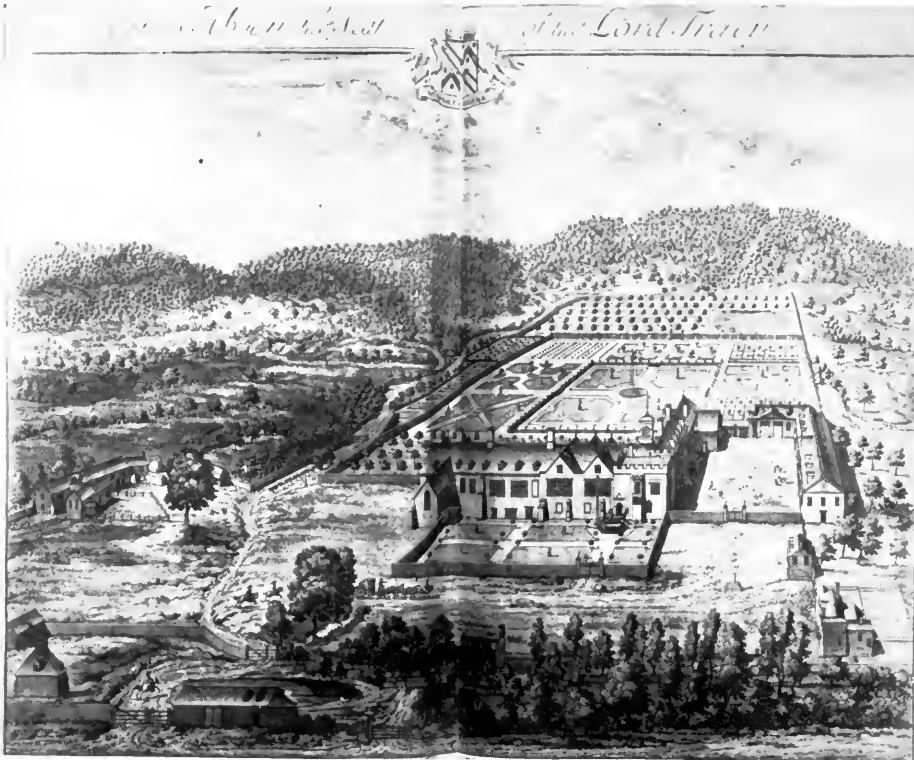

MONASTERY FOUNDED IN 1246 BY EARL OF CORNWALL, LATER KING OF THE ROMANS

Exhibit 4—Hayles Abbey became part of Toddington in 1357, and was occupied by William Tracy when he became interested in New World exploitations which resulted in his financial ruin and the establishment of the Tracys in America — Rare print in 1712

twelve years of age, 979. His reign was remarkable for his long and bloody wars with the Danes, and for the general massacre of them in the year 1002. He died 1016 and left eight sons and four daughters. GODA, the youngest of king Ethelred's daughters was married to Walter de Maigne (or de Mantine or de Mantz etc.) a nobleman in Normandy. RALPH (Rudolph etc.) son of GODA and Walter de Maigne was Earl of Hereford. HAROLD son of Ralph was lord of Sudeley; and the Tracys do now give the same arms as this lord Sudeley gave, only with an escollup shell for difference. JOHN the son of Harold married Grace the daughter of (Henry de) Traci, lord of Barnstaple in Devonshire. WILLIAM TRACI, second son of John, lived in the reign of King Henry the Second, and took his mother's name Traci. He held lands of his brother Ralph de Sudeley by one knight's fee, and was of the same name (de Maigne) and is supposed by some to be one of the four knights who murdered Thomas Becket

archbishop of Canterbury. OLIVER TRACY, son of William, lived in the second year of King John, and had issue SIR WILLIAM TRACI of Toddington, who lived in 17 Ed. I. and was granted in wardship of Lawrence Fresham 1298. He was high-sheriff of Gloucestershire 1319. John Archer son of John of the ancient family of Archers in Warwickshire married Margaret daughter of this Sir William Tracy of Toddington, in the reign of Edward the Second.

In the preceding evidence appears the statement that "the abbey of Hayles was presented to Toddington, 1357." As it is in the record of this abbey that I shall begin to establish the relations which connect this line of nobility with the American Tracys, I here present my investigations of Hayles Abbey. (See Exhibit 4.) Sir Robert Atkyns, on page 246 of his "History of Gloucestershire," pub-

Unbroken Line of Descent from King Egbert

lished in 1712, makes this record and gives a picture of the Abbey as it was at that date:

This parish lies in the lower part of Kiftsgate hundred, two miles distant north-east from Winchcomb, and seven miles east of Tewksbury, and thirteen miles north-east from Gloucester. It is so called from Haly, which is Saxon for Holy. This manor, at the Norman conquest, fared like the rest of England. It was taken from a Saxon proprietor and given to a Norman. . . . It afterwards came to the crown, and the inhabitants thereof were then discharged from the hundred of Winchcomb, to Hen. III. King Henry the Third granted it to his brother Richard earl of Cornwall, who in this place founded the famous monastery of Hayles 30 Hen. III. in the year 1246. This great earl was elected king of the Romans. He had escaped a shipwreck; and in performance of a vow made in the extremity of danger he erected this monastery, and placed therein twenty Cistercian Monks, and ten converts, which he brought from Beavlieu in France; it was dedicated to the Virgin Mary, and All Saints, by the bishop of Worcester, the fifth of November in the year 1251, in the presence of the King Henry the Third, the queen, thirteen bishops, many noblemen and three hundred knights. This great earl and his wife were buried here. He died 1271; she died in the year 1261; so that the church of Hayles contains the ashes of an emperor and an empress. Edward earl of Cornwall, son of the founder, was likewise buried in this church, whose burial was performed with great solemnity in the year 1300; King Edward the First, and a great concourse of noblemen, attending at the funeral. The church and most of the buildings was consumed by fire in the year 1271, which was but twenty years after the first foundation; yet the loss was estimated at 8000 marks. . . . The abbot and convent of Hayles paid an annual rent of 16*l.* 16*s.* 10*d.* ½ for Pinnockshire, 27 Ed. I. which rent was the same year settled by the king on queen Margaret as part of her dowry. The abbot of Hayles was made a mitred abbot and summoned to parliament 1294. Adam le Hunt grants twenty solidates of land in Hayles to the abbey thereof 13 Ed. II. The abbot of this monastery took part against King Henry the Fourth, and was hanged. Abbot Whaley was the last abbot, who in hopes of a pension, surrendered it to the king Henry the Eighth the twenty-fourth of December, 31 Hen. VIII. This monastery was valued at Disolution at 357*l.* 7*s.* 8*d.* ½. Edmond, the son of the founder, gave some of *Christs Blood* to the abbey; and at the Disolution it was discovered to be the blood of a duck; which

was weekly renewed. This forged miracle had been practiced in this monastery for many ages; and it was affirmed of it, that, if a man was in mortal sin and not absolved, he could not see the blood; but as soon as he was absolved, he might plainly discern it. The priest shewed it in a cabinet of crystal, richly adorned; both sides whereof seemed alike, yet one side was composed of thicker crystal than the other; and until the penitent had paid for as many masses as the priest thought fit, he presented towards him that part of the cabinet with the thicker crystal, when nothing could be seen; but when he paid well, then the thin and transparent side was turned towards him, and then to his great joy he could discern the blood. This miracle had much enriched the monastery. One of the cloisters is yet remaining (1712). After the disolution of the abbey, the scite of the monastery, with the manor, Hailes wood Pinnock's wood, and Hailes park, were granted to sir Thomas Seimore 1 Ed. VI. who being attainted, the scite of the monastery, with the rest of the lands, was granted to William, marquis of Northampton. The manor afterward came to William Hobbey, esq. [He was the first husband of William Tracy's youngest sister Mary Tracy] who built a little chapel not far distant from the abbey, wherein he lies buried; he died 1603 aged 103. The Tracys soon after became lords of this manor. William Tracy, esq. was lord of this manor in the year 1608.

With the family seat established at Toddington, I now turn again to William Tracy, of the twenty-eighth generation, who was born at Toddington, and emigrated to America in 1620. The first record of him in Hayles is from "The Names and Surnames of all the Able and Sufficient Men in Body fit for His Majesty's Service in the Wars within the County of Gloucester," compiled by John Smith, in August, 1608, in the sixth year of the reign of James the First, giving his servants and retainers on pages 84-85: Hayles

William Tracy Esqr.

Charles Townsend gent.

John Rawles

John Hicks

John Staube

John Worley

Henry Carnall

William Carnall

Thomas Jeffrey

William Sexton

Servants to the said
William Tracy, Esqr.

The Progeny of Saxon Monarchs in America

Sir Horatio Vere Knight hath one lance, one light horse, two Corslets, three muskets and two Calyv's furnished.

Britton's chart shows that William Tracy's youngest sister married this distinguished General Horatio, Lord Vere of Tilbury (See Exhibit 3), and the paragraph given above shows that William Tracy was not the owner but a resident of Hayles. The form of ownership in all the records of that period explicitly states the ownership. I do not know of an instance where it is omitted. If William Tracy had been the owner, as stated in one of the preceding quotations from an eminent historian, which I am inclined to believe was merely a hasty conclusion without proof, the record of Hayles would read: "Hayles, of which William Tracy, esq., is Lord." This fact it fails to state. When William Tracy was married, his father, Sir John Tracy, knight, gave him Hayles not in fee, but as a residence, and there he lived until he went to Virginia in September, 1620, and in the usual course of events his children were born in Hayles. The ownership of Hayles fell to his oldest brother, Sir John Tracy, Viscount of Rathcoole (See Exhibit 3), who had several children.

William Tracy, Esquire, (28) was one of the first of those of gentle blood to become interested in the development of the New World, and he became actively engaged in promoting the settlement of Virginia. In the "Records of the Virginia Company," January 26, 1619, now preserved in the Library of Congress, volume I, appear these entries:

At a Great and General Quarter Count Holden for Virginia at Sr Edward Sandys House neer Aldensgate the Second of February 1619 (page 303).

3 GRANTS OF LAND

The Third of Grants of Land he acquainted them of fower seu-all paire of Indentures lying all ingrossed before them granted one to Mr Robert Heath Recorder

of London and his Associates, the s'cond
4 PAIRE OF INDENTURES ALLOWED
to Doctor Bohune, James Swift and their Associates for Transportation of 300 Persons. The Third to *William Tracy esquire and his Associates for Transportation of 500 Persons.* . . .

28 Junij (June) 1620: William Tracy of Hayles Esqr. to be Councill of Estate in Virginia.

SUPPLY OF COUNCELLORS IN VIRGINIA

Vppon notice from Sr George Yeardley yt the Councells in Virginia must needs be supplied, the Court hath now chosen mr Thorpe, mr Nuse, mr Pouutus, *mr Tracy*, mr Daved Middleton, and mr Bluett to be of the *Councill of Estate in Virginia* (page 379).

Sir Edwin Sandys further signified that itt was then also taken into their consideration and thought fitt that the *Councill of State in Virginia* should assemble fower times a year each Quarter once for one wholl weeke together to advise and consult upon matter Councell and State and of the generall affairs of the Colony and as there shall come to order and determine the greater matters of controversee growinge and arising between the Plantations there being now added a good number of new Councellrs to the former, namely, (as before specified) (page 479).

Whereas Credible information hath been given of the Death of Doctor Bohune mr Ouldsworth, and *mr Tracy late chosen to be of Councell of State in Virginia,* . . . (page 520).

At a Court Held ye 24th October 1621: mr John Smith moved that whereas *mr William Tracye afore his goinge over to Virginia was arrested 200li (pounds) principall debt for wch he put in bayle wch suit hath since proceeded and bine psecuted soe as the said cause was ready for iudgment whereof stay was made vntill some witnesses might be brought in to certify of the said mr Tracyes death.* In respect whereof and for that hee hath received information by tres that the said *William Tracye dyed in Aprill last* hee desires, notice of such as came lately from Virginia that may be ready vppon occasion to witness the death of the said gentleman touching wch the Company promised to procure him as many as they could hereof. (page 535).

Evidence of the intimate relations of William Tracy of Hayles with the

Unbroken Line of Descent from King Egbert

Virginia promotion, his ultimate immigration into America, and his influence as a counsellor and finally governor of the first permanent English settlement on the Western Hemisphere, is conclusive in the ancient letters in his own handwriting and almost indecipherable documents in which he is frequently mentioned. The originals are deposited in the Lenox Library in New York in charge of Mr. Wilberforce Eames, Librarian, to whom I am much indebted for the privilege of taking photographic copies. Many of the letters are nearly past translation and to preserve their contents as a contribution to early American history they have been transcribed and published in the Bulletin of the New York Public Library. The first one which I shall introduce is a letter written on April 15, 1620, by William Tracy to John Smith in which it appears that Smith had advised Tracy to buy Throckmorton's share in the Virginia colony of Berkeley Hundred and showing that he (Tracy) was acting on his (Smith's) advice:

Sr

I was glad of yor letter & ye good newes of virginia, but sori ye ship is not returned god send her a hapi Coming & all ouer bisnes hapili to go on to gods glori and ouer good there is a gust Caues yt I cannot met at gloster, as yo loue me Condem me not so do I intret my Cosin barkli what so ever yo to agre on I will Consent vnto be Caues I am asured yo will do nothing vnfitting yo selves Yf I may know wher to met my cousin barkli ye first nite I will not fayle & it may be goe a long with him to london Yf not with yo yf yo go from ouer parts. but at london there shall we haue tim suffisient to determen all I am now binding my men I haue at lest 20 promised me ye most part I am suer of. there is no dout of more then wee men at this to Cari. ti all of yousefull trads so yt we may leaue those yt ar of lest employment tel ye next going do as you plese with Sr William Throckmorton I will do nothing but as yo aduise me Yf I proue not ferm & faythful let me not be held worthi ye nam of a Crisition this hoping this may geve yo satisfacione I rest

Yors in all asurance

15 April 1620

WILLI TRACY.

[Addressed:] To my worthi frind Mr
John Smith this nibli
[Endorsed:] Mr Tracy's letter 1620

That William Tracy of Hayles did purchase Sir William Throckmorton's share in the Berkeley Hundred Plantation in Virginia in 1620, for which he paid £75, is witnessed by the following accurate transcript from the original indenture:

This Indenture made the seventh day of May, 1620, in the xvijth yeare of the raigne of our soueraigne lord king James of England france and Ireland and of Scotland the liijth Betwene Sr Willm Throckmorton of Clowerwall in the County of Gloucester knight and baronet of the one parte And Willm Tracy of Hayles in the said county Esq; of the other parte. Whereas the said Sr Willm Throckmorton Sr George Yardley knight Richard Berkeley Esq; George Thorpe Esq; and John Smyth gen. did procure from the Treasurer and company of Adventurers and planters of the city of London for the first Collony in Virginia by the advise and consent of the Counsell of the same One Indenture of Covenants and grants sealed with their Comon seale bearinge date the third day of february in the xvjth yeare of his maties said raigne of England and of Scotland the liijth for their better enablige and encouragement for plantacon in Virginia aforesaid And for dyuers other causes purposes and intents As in and by the same Indenture more at large it doth and may appeare. . . . Nowe this Indenture witnesseth that the said Sr Willm Throckmorton for and in Consideracon of the some of 75li of lawfull mony of England well and truly before hand payd by the said Willm Tracy . . . hath given granted assigned and set over . . . vnto the said Willm Tracy his executors administrators and assignes All and singular the interest benefit property and advantage whatsoever which he the said Sr Willm Throckmorton nowe hath or by any wayes or meanes whatsoever shall or may have or make of from by or by reason of the said Indenture or of any grant clause covenant sentence or agreement therein containned eyther for the present or hereafter to come.

Early in 1620 William Tracy was granted a Captain's commission for "a voyag intended to Virginia:"

WHEREAS wee the Treasurer Councill and Company for Virginia for the better advancement and supporte of that Plantacon haue given leaue vnto such as shall

The Progeny of Saxon Monarchs in America

furnish out our good Shipp of Bristol called the supply of the burden of Threescore and Tenn Tuns or thereabouts to passe with all convenient expedicon vnto Virginia. William Tracy Esquire beinge ordained to be the master and Captaine therof and to Comaund and governe the said Shipp and Marryners and alsoe all the passengers put aboard for the said voyage to be landed in Virginia for a *particular* plantacon beinge to the number of sixty five persons or thereabouts with all such necessary *provisions* as are shiped for their vse and necessary releife We doe therefore hereby Charge and Comaund him to take his direct course accordinge to his best skill and knowledge vnto the said plantacon in Virginia and there to land and put on shore all the said persons and goods soe shipped of what kind soeuer. Straightley chargeinge and Comaundinge the said William Tracy to sett saile from England with the first oportunyty of wind and to make all possible speed he may to the port intended and not to Interrupt any shipinge of the *subjects* of any of his Maty ffrends or allies or any other whoe soeuer duringe his said voyage. . . . In wittnesse whereof wee haue herevnto annexed our Comon Seale. Dated by order of a generall Court houlden for Virginia the twelfth day of July in the yeare of our lord God .1620. And in the eighteenth yeare of the kings Maties raigne of England fraunce and Ireland And of Scotland the three and fiftieth.

Sealed in presence of.

Fra: Carter

It is evident that William Tracy of Hayles invested heavily in the development of the New World, for nearly all of his letters are of a business nature regarding Virginia investments and bespeak his honor and financial integrity in meeting all obligations promptly. This transcript from a letter in 1620 upholds this contention:

tomorrow by gods leaue shall I paye yo a rooli at leste before at seuerall times 95 ye rest with all spede shall be sent in as I haue agreed with yor man. so yt within 10 dayes I hope to pay vnto yo 300li with vt allredi payd . . . Yf yo all will Consent I doute not but yt yo will take paines & Car for ouer bisnes & I will requit yo with my paines in Virginia & so will rest in all asurance

Yor ever WILLI TRACY

I canot her whether my cosin barkli haue taken a ship or not Yt Care must be on yo to my bisnes will not suffer me to seke after on & without on all is nothing good

Sr Consider I haue manie bisnesis & non to helpe me.

[Addressed:] To my asured frind mr John Smithe at ye blue lion in Chancery lane this.

[Endorsed by J. Smith:] Mr. Traceys *lettre* about his dispatch into Virgynia, June .1620. .18. Jac. sent mee to London.

It is in a letter written by William Tracy just before sailing for America in 1620 that he mentions his family, "my wife & dauter & sun." It is this "sun" that I prove to have been Lieutenant Thomas Tracy of Massachusetts and Connecticut. Therefore I call especial attention to Exhibit 6, which is an exact photographic reproduction from the original letter. Owing to its eccentric orthography it is here translated according to accepted version of handwriting experts in the service of the Lenox Library at New York. I contend that the mention of the "dauter" first, giving her precedence over the "sun," is a positive indication that she was the older. It was the irrevocable custom of the period to give the sons precedence. Under a monarchical system in which heredity is law and the lines of descent are established through the males, the daughters were never mentioned first except through a distinct superiority of age. In an instance of this kind it is definite proof that the daughter must have reached maturity while the "sun" must be still in childhood; otherwise this precedence of female over male could not have occurred in a family bound fast to the laws of heredity and cherishing as sacred their descent from the Saxon Kings. While nothing has been found that gives the dates of birth of either of William Tracy's children, I shall continually corroborate this statement that the "sun" was in his childhood when his father came to America in 1620, and the daughter had reached maturity. This is the translation of the letter that establishes their existence:

non more glad of yor recoveri then I god Continue ye increase & Continuanc of

Unbroken Line of Descent from King Eglbert

25

I
 you most glad of yo^r returne from
 god continue in interest & contentment
 of all helth & happiness to yo^r I will
 say little because I hope god will bring
 yo^r speedy returne where yo^r will find
 great necessitie both here & there as will
 should yo^r have dined at last. I will
 think as yo^r write to have had some
 be left home returned to yo^r wife &
 2 necessaries returned of yo^r & shall be
 glad to see yo^r returning here. I will de-
 sperate will be made of some in it & most
 desire to hasten to rest in god send yo^r
 well to do & bid yo^r god with ever kind
 1. September
 1620
 yo^r in all love
 I commend me to yo^r willie Cook
 write of rest & tell them of I must
 take speede words with you & board at
 Bristol than shall take at hand in Virginia
 resolution to be in earnest than shall
 be mettom @ me will part god will

AUTOGRAPH LETTER OF WILLIAM TRACY OF HAYLES AS HE LEAVES FOR VIRGINIA IN 1620

Exhibit 5—Written to John Smyth, inviting his friends to dine with him and looking forward to an opportunity of entertaining them in Virginia—Original from which this almost indecipherable letter is taken is in archives of Lenox Library at New York

534

The Progeny of Saxon Monarchs in America

I have in my Company 4 maid servants
 3 married wifes & 2 young Children
 my wife & daughter ^{at home} ~~at home~~ no rest
 & consider our ship will hold but 45 men
 men being if more excellent & you shall
 truste times all to serving for men
 that cannot be convenient of some for all
 had a great selfe no rest of god will
 be no more

AUTOGRAPH PROOF OF WILLIAM TRACY OF HAYLES BRINGING HIS SON TO AMERICA

Exhibit 6—Postscript to letter written to his intimate friend, John Smyth, first day of September, 1620, in which he enumerates his family accompanying him on his departure for Virginia—(Original in the archives of Lenox Library, New York)

all helth & hapenes to yo I will say
 litell becaues I hope god will bring yo
 spedili hether wher yo will find gret
 neckeckte hath bine such as will hould vs
 her 12 dayes at lest. such things as yo
 writ to haue baut shale be I haue retorned
 yo ye boke & 2 writings receued of yo
 I shall be glad to se yo knowing then mi
 despach will be much ye soner which is yt
 I most desier so hasting to rest with
 god send yo well so do I bid yo god nite
 euer being
 Yours in all loue

WILLI TRACY

i. September
 1620

Commend me to mrs. smith & ye rest &
 tell them yf I must eate shipes mogets
 with them a bord at bristoll thay shall
 eate at land in virginia pocahikiti with me
 in earnest they shall be wellcom & wee will
 part goyfulli

I haue in my Compani 4 maid saruants 3
 married wiuies & 2 young Children my wife
 & dauter & sun remem mr Portar & Con-
 sider ouer ship will hould but 45 men
 men being ye mor excelent & yousefull
 Cretuers twer Ill to Chauing for wemen
 ther Cannot be Conuenienti of rome for
 all thes a suer yor selfe mr palet I hop
 will be with mi sune.

[Addressed:] To mi asured frind mr
 John Smith this.

[Endorsed:] mr Traceys lettre 2. sept.
 1620. from Bristoll.

To still further corroborate the con-
 tention that the order of precedence
 could not have been carelessness, es-
 pecially with a man in whom the laws
 of heredity were religiously observed
 as sacred and in whose veins flowed a
 blood that for twenty-eight genera-
 tions had held its nobility through
 these laws, I introduce an accurate
 transcript from another letter written
 at another date in which William
 Tracy observes the same form of pre-
 cedence "my wife, dauter & sune."

... my howsold will be my wife
 dauter & sune 4 mayd saruants & 6 men
 so then for ye rest as mani or as fewe as
 yo will mr palet & mr gilfort must be to
 more of my Compani so I shall be .16.
 parsuns at lest. my mening is all these
 shall be Employed in ye Comon bisnes
 twer good to make them 30. I haue sente
 yo letters to Consider of so leauing yo to
 god
 Yor ever asured

WILLI TRACY.

I would Cari .10. or 12 dogs yt would be
 of gret youse to vs. let me know yf thay
 will let vs Cari them.

5 Juli .1620.

[Addressed:] To my asured worthi good
 frind. mr John Smith this.

[Endorsed:] . . . July .1620.

Unbroken Line of Descent from King Egbert

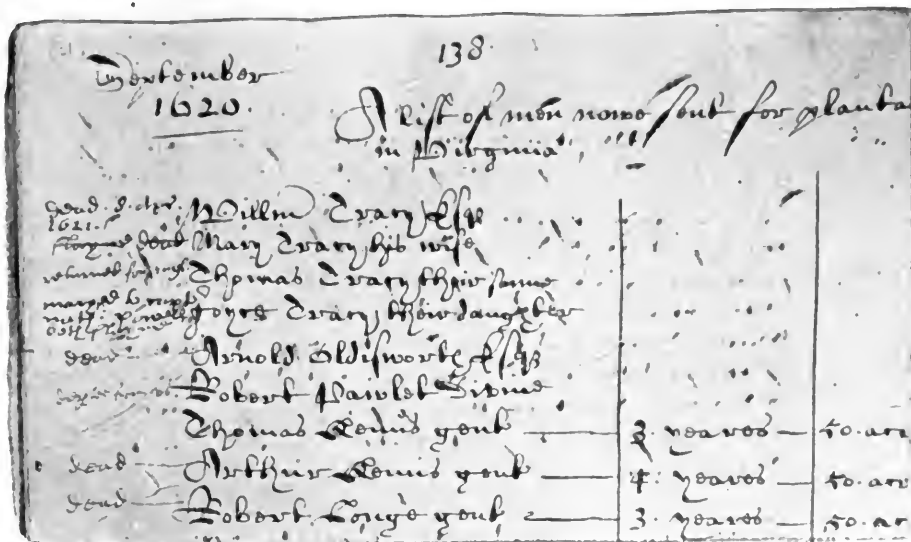

IDENTIFICATION OF THE FAMILY OF WILLIAM TRACY OF HAYLES IN AMERICA

Exhibit 7—Record of his death, April 8, 1621; the marriage of his daughter, Joyce, and her tragic death; and the return of his son, Thomas Tracy, to England—The marginal notes are in the handwriting of John Smyth—Original in Lenox Library

The arrival of William Tracy of Hayles, and his wife, daughter and son, in America is evidenced in the photograph of a portion of a page of the record of the Virginia Company preserved by John Smith. I call your attention to Exhibit 7, which is the original list of "men nowe sent for plantacon in Virginia," and is dated "3 September 1620." In this document are revealed the names of the children and their fates. The marginal notes, recording deaths, are in the handwriting of John Smyth:

- 3 September 1620. A list of men nowe sent for plantacon in Virginia.
- Willm Tracy Esqr (dead .8. Apr. 1621.)
- Mary Tracy his wife [slayne and dead written by Smyth in the margin and then stricken through]
- Thomas Tracy their sonne (returned for Engl.)
- Joyce Tracy their daughter (married to Capt. Nath. Powell. both slayne)

The investments of William Tracy in Virginia proved financially disastrous. He was continually called upon

for funds in promoting the colony and pathetic appeals show that his entire estate was consumed in the New World speculation which proved a total financial loss. Consequently the son, Thomas, recorded in Exhibit 7, was ultimately left destitute in America, as witnessed by letters. This is a translation of Exhibit 8:

I woul[d] say mor but know not what my wif is ouerwhelme with grefe at bristoll we onli haue this vn sarten hop yt ye fayer will furnish vs with a ship. mr barkli layes all ye falt on yo but all ye burden lieth on me. yo haue nibli he hath stok I haue nothing but verginia & yt am I held from to liue in shame & disgrase in Eingland for gods loue howld mr felgate sarten to go with vs & yf we must go from bristoll which is my desier mak hast doune & help me a man by all menes & by gods help it will be for ouer good I hau to hundered & od pounds & ye 3 in mr Webbes hand this will I ingage for to furnish & forward this Jorni leaue me not I will neuer leaue yo but be as I ought & so will rest
Yors WILLI TRACY
14 Juli .1620.
[Addressed:] To I hope my frind yt will not leaue me mr John Smith this

So serious became the financial straits of William Tracy through his

The Progeny of Saxon Monarchs in America

I cannot say more but know not what
 my wit is overwhelme in griefe
 at bristol we onli have this in father
 hope if the forces will for my selfe no more
 in handli lande all is fall on yo but
 all is burden litle on me yo have
 wiblye hate stoff I have not my but
 verginia & I am held from to time
 in shame & disgrace in England
 for godd love honord me felicit sister to
 yo the only one we must go from
 bristol in my desire will last
 done & helpe me a man by all means
 & by godd helpe it will be for ever good
 I have to byndred & od rememb
 & if I in me misset hand I will
 I mudge for to furre & forward I will
 for me leave me not I will never
 leave yo but be ab I forget & I will
 rest yo
 14 July 1620
 yo willi tracy

PATHETIC LETTER OF WILLIAM TRACY OF HAYLES CONFIDING HIS LOSSES IN AMERICA

Exhibit 8—Written to John Smyth on July 14, 1620, when in despair because of his financial embarrassment from the unprofitable investment of his entire estate in Virginia which left his family destitute—Original in Lenox Library, New York

Unbroken Line of Descent from King Egbert

Virginia exploitation that he became involved in debts which resulted in much humiliation. In a letter written to him by Timothy Gate, a kinsman, in 1620, these facts are made plain:

Good cosyn I beare a parte in my mind of your unhappines I received a *lettre* from my brother Cuynter which my cosyn Bridges brought me vnto Ockle the contents was that I should take such security for his mony as I thought fitting from thence I went with him vnto Cleene from thence to Beckford vnto mr Wakemans house and there I toocke all his part of tobacco assigned vnder hand and seale before Wittnesses with mr Wakemans consent. my brother vpon my kuoledg was content to take 2000 pound of his tobacco. he hath formely told me soe and writt soe vnto me my cosyn was content to passe his corne or any thing he had for your releaf but I thought that sufficient and that yt would content him I am hartily sorry he should deale thus cruelly with you I writt vnto my brother what I had donne and that he would release you according vnto his *lettre* for my cosyn Rob Bridges he is soe sensible of your hinderance and his owne discreditt by your Arrest that he seemeth vnto me as I protest vnto you infinitely perplexed in his mind he hath travelled twise vnto my brother and backe agayne little meats and rest serveth his turne. he would doe any thing in his power to free you he voweth vnto me and I am confident he will performe yt if you can procure any suerties he will with all speed possibly he can se them discharged. If he should be slack I will remember him but he is as careful of you as he can be and would vndergoe any losse or paynes to free you but vpon the suddayne he cannot doe what he would or should doe herin if you will write vnto me to speake vnto any frend you haue here If my payns care and best furtherance shall not be wanting for I desyre god to bleshe me and myne as I wishe your well-fayre I hope the Sea wilbe more mercifull vnto you then your frends are hire I hope after this storme you shall have fayer weather my prayers and best endeavors shalbe for you

I rest
your kinsman
in affection
TIM GATE

Ockle Sept 22th

[Addressed:] To my worthie good cosyn mr Willia Tracy att Bristol these.

[Endorsed:] mr gates *lettre* to mr wyntour

The burdened state of mind and the embarrassment which William Tracy of Hayles suffered because of his ven-

ture in financing the American expedition is confessed in a letter which he wrote to his friend, John Smith, in which he feared that he might be forced to remain in England in want and gave way to his discouragement with the words: "When all is gone I cannot live."

SR

Yf yor help be not more then mr barklis I am vndon piti my destresed Case. & sumthing yor own Credit is Ingaged to se me prouided to go & those ther releued. my trust is in yo and out of ye trust in yo did I prosed. in much grefe do I writ ease my hevi hart or kill it outrit. let me go on ani condisions I yeld to yor desier thoth vnfit I should run so gret a dainger & yo go on sartenties do yor will *so I may not stay to want at home* mr barkli will not send but by ye poule & tun & is of yor mind yt I should hier ye ship by ye moneth to tari her will be mor lose therefor helpe yf yo Can posibel mr barkli will Consent but to Cari 20 men do yor best to get me & 10 parsumes or as mani or as few as yo Can or think fit *When all is gon I Cannot liue* therefor send me wher I must leue my trust is in yo fayle me not I Can say nomore but leaue all to yor desecresion & rest

Yors

WILLI TRACY

14. Juli. 1620.

I leane much to mr felgat to discourse who sawe mr bark[li]es cariog.

We lose all ouer men yf we go not nowe besids putting the[m] out of work & *me out of credit.*

[Addressed:] To my worth good frind mr John Smith this.

[Endorsed:] . . . 14 July 1620 by Toby felgate.

William Tracy was held for a debt of 200 pounds incurred in fitting the ship "Supply" for the voyage to America. Placing this responsibility on William Tracy was unjust as the debt was contracted for the company and not for the personal advantage of William Tracy. There was an agreement that certain amounts should be paid by certain persons in furnishing the ship which was sent out from Bristol in September, 1620, under the command of William Tracy. This transcription from the original books of the company at that date proves that William Tracy had paid his share:

The Progeny of Saxon Monarchs in America

Sent to mr Tracy vpon his *lettres* after I was come to Nibley to be supplied, whilst he lay for wynd at Crockamply with all his company &c. xli

Sumo total of this wholl charge disbursed till this ships departure .18. Sept. 1620. 702li 11s 6d

Wherof 4th part is 175li 12s 10d ob.

Of which iijta pars of 175li 12s 10d ob. mr Berkeley and his partners have payd but 50li

The residue beinge 125l 12s 10d ob. is to be cast upon mr Tracy by agreement.

Of which 4ta pars of 175li 12s 10d ob. mr Smyth hath payd the wholl for mr Thorpe.

Of which 4ta pars of 175li 12s 10d ob. mr Tracy hath payd the wholl by the hands of mr. Smyth.

Almost driven to desperation by his financial encumbrances, William Tracy pleaded with his worthy friend, John Smith of Nibley: "Send me away and by God's leave your good shall be equal with mine. . . . I have put myself out of all means to live here:"

Sr
My estat is such yt I must stir yo on be yond good mannars, neuer mor I hop to be trobelsum but euer laboring to make satisfaktion. send me away & by gods leaue yor good shall be equall with mine. in god my Chefe trust is nex yo as his Chefe instrument to finish this work as yo loue me youes all menes to take a ship tel yt be don I shall not be meri. blam me not for I haue put my selfe out of all menes to liue here & am dayli in extrem expensis which wekneht my to wek purse for so gret a bisnes good Sr haue a felow feling with me by this yo may se my longing hart to be gon to ye plase wher my bisnes is. I know you vnderstand faythfullness & Constanci is such yt I ned say no mor so will refer to yor best Car all this gret bisnes & euer rest
Yors to comand
2 August 1620. WILLI TRACY.
[Addressed:] To my worthi good frind Mr John Smith of nibley this.
[Endorsed:] Mr Tracys *lettre* .Aug. .1620.

In the midst of the financial difficulties of William Tracy, one John Bridges writes a letter to John Smyth in which he speaks of William Tracy as his cousin and offers financial assistance. It must here be noted that in Exhibit 3 it is shown that the grandfather of William Tracy married Elizabeth, daughter of John Bruges or Bridges, first Lord Chandos of Sudeley. It is through them that I shall later produce corroborative evidence that Thomas Tracy of Massachusetts and Connecticut was the son of William Tracy and Mary Conway left destitute in Virginia. The following letter and Exhibit 9 are here presented to still further vouch for the relationship of William Tracy, of Hayles and Virginia, and the Bridges:

Sr
Nidinge to send these letters to my cosine Tracy, I spake with mr Thorne, who tould me that by Sr Willm Throkmorton, and your selfe my cosin Tracy was sett at libertie—which did not a little reioyse me: I will not trouble you with many lines in this letter, by cause yf my cosine Tracy be gon, I desire you to opene his letter, yf he be *with* you I knowe he will acquaint you with what I haue writ: I desire that you will directe me what course to take for the remouinge of the action into the Chansery, and I will followe it with all speed, or yf your selfe will be pleased to followe it, all chardges shallbe mine, thus beinge sorry for the wronge done unto my cosine Tracy by that basse extorcioner winter, I desire to heere from you and will ever rest
your assured louinge ffriend
Jo: BRIDGES

Castlett the 23th
of Sept. 1620
[Addressed:] To my mutch respected ffrind John Smith, esqr.: at nibley be these deliured.
[Endorsed:] mr Bridges .i. *lettre* to mee Sept .1620. [with seal]

The confidence which the Virginian investors reposed in William Tracy is demonstrated by his appointment as governor. The original document addressed to George Thorpe, Mr. Tracy's coadjutor, and signed by Richard Berkeley and John Smyth, is preserved at the Lenox Library, and a photographic reproduction of a por-

Unbroken Line of Descent from King Egbert



AUTOGRAPH PROOF OF FINANCIAL EMBARRASSMENT OF WILLIAM TRACY IN VIRGINIA

Exhibit 9—John Bridges to John Smyth, September 23, 1620, in which he speaks of William Tracy of Hayles as his cousin and offers financial assistance—This letter also helps to identify Thomas Tracy of New England in 1636 as the lost son of William Tracy of Hayles and Virginia—Original in Lenox Library

tion of it is here presented in Exhibit 10:

[After our very hartie commendacions: wee send herewith vnto you, a Comission to discharge the gouernement and authority, which last yeare was by vs and yourselfe conferred vpon Captayne Woodleefe wher-to your ownee hand and seale is to be affixed, if you have cause to make vse therof, which wee leaue to the wisdom of yourselfe and Mr Tracy we have conferred the wholl gouernement of all our people and affayres ioyntly by one other Comission vpon yourselfe and Mr Tracy accordinge to the tenor of the former to captayne Woodleefe] makinge noe doubt of your prudent vsage therof, profitably also for yourselues and vs. . . . With our affectionate comodacions we bid you hartely farewell and rest

Yor assured loving frends

RICH. BERKELEY. JOHN SMYTH.

Stoke saturday
10 Sept. 1620.

The financial misfortunes of William Tracy of Hayles did not shake

the faith of his colleagues, who held him in high esteem for his services to the first permanent English settlement in America when it was in dire need and about ready to abandon the continent and return home after years of poverty, famine and massacre. This is shown by the agreement between Richard Berkeley, George Thorpe, William Tracy and John Smyth, in which Thorpe and Tracy are selected as governors of the colony on August 28, 1620:

Item it is further agreed that for the better augmentacon of the number of their said servants and collony already in Virginia That another ship called the supply shall in the month of September nowe next followinge be sent from the said port of Bristol furnished at their like equal costs and charges in all things with .540. persons or therabouts, And that the authority and gouernement of the said men and all others eyther already in Virginia or hereafter to

The Progeny of Saxon Monarchs in America

(26)
 After our very hearty commendations, wee send herewith unto you, a
 Commission to discharge the government and authority, wee last year
 made by you, and your selfe conferred upon Captayne Woodroffe
 wherby your good hand and state is to be officed, if you have cause to
 make it to be proved, wee are leade to bee wisdoms of your selfe and in every
 we have conferred by whole consent of all our people and assent
 by our selfe Commission upon your selfe and in every proceedings to
 bee done of the former to Captayne Woodroffe, makinge no doubt of
 your excellent sage counsel, especially also for your selfe and

AUTOGRAPH DOCUMENT APPOINTING WILLIAM TRACY OF HAYLES GOVERNOR IN VIRGINIA

Exhibit 10—Instructions from Richard Berkeley and John Smyth to George Thorpe, September 10, 1620—This document qualifies for membership in Society of Colonial Governors—The original is now in the archives of the Lenox Library in New York

be sent and of all other their affaires in Virginia shall be in the said George Thorpe and Willm Tracy Joyntly as sole governours and directors of all manner of businesses there soe longe as they two shall agree in one and not be divided in opynion.

of them shall agree vnto and determine of in wrytinge, wherto they the said Rich Berkeley and John Smyth faithfully promise to submit themselves without longer contradiccon argument or gaynsayinge. Given Enterchangeably vnder their hands and seales the day and

examine or diversion, but none of your selfe, wherby any suspension
 delay or neglect of the said business shall or may be like
 to arise or to be delayed nor looked at hindered, yett for here in
 England or in Virginia by the best meanes, yett by the best meanes
 maynard and proceedinge shall be as C^r Willm de Grooton knight
 and baronet C^r deo. the knight and C^r deo. every knight brother
 of the said Willm, or any two of them shall agree vnto and
 determine of in wrytinge, wherby they the said King Berkeley
 and John Smyth faithfully promise to submit themselves
 without longer or vnto contradiction argument or gaynsayinge
 Given Enterchangeably vnder their hands and seales the day
 and yeare first above wrytten.

IDENTIFICATION OF WILLIAM TRACY OF VIRGINIA AS SCION OF TODDINGTON MANOR

Exhibit 11—Written August 28, 1620, appointing William Tracy a Governor in Virginia and mentioning him as brother of Sir Thomas Tracy, Knight of Toddington, and son of Sir John Tracy of Toddington, direct descendant of Saxon Kings—Lenox Library

In concluding this agreement a record is made of the relationship of William Tracy and Sir Thomas Tracy, knight, as brothers. See Exhibit 11 in which these lines appear:

[In case of disagreement is is agreed . . .] that the resolucon deternynacon and proceedinge shall be as Sr Willm Throkemorton knight and baronet Sr Tho: Roe knight and Sr Tho: Tracy knight brother of the said Willm or any two

yeare first above written. (August 28, 1620.)

This foregoing record corroborates the pedigree in the chart offered as Exhibit 3 at the beginning of this argument, in which William Tracy of Hayles and Virginia (cousin of John Bridges) who married Mary, daughter of Sir John Conway, of Arrow, County of Warwick, sister

Unbroken Line of Descent from King Egbert

of Lord Conway, is proved to be a direct descendant in unbroken line of succession to Egbert the first Saxon King of all England. Britton's chart records William Tracy as dying without issue. I have proven this erroneous by William Tracy's own handwriting and by the records of Virginia. He had a son and his name was Thomas as witnessed in Exhibit 7.

In this same Exhibit 7 it will be found that John Smyth in his own handwriting entered a record of William Tracy's death on April 8, 1621, in the midst of his financial misfortunes in Virginia; that his wife, Mary (Conway) Tracy, was "slayne and dead," but these words are stricken out; that his daughter, Joyce, married Captain Nath. Powell, and both were slain; and finally that the son, Thomas Tracy, "returned for England."

With this tragical ending of the American speculations of a scion of the House of Ethelred, the Saxon King, I rest this first part of my argument and turn to Lieutenant Thomas Tracy of Massachusetts and Connecticut, from whom a large part of the Tracys in America descend, inasmuch as it is proven that the Tracy expedition to Virginia not only proved a financial disaster, but ended in a tragedy.

The words "slayne and dead" written by John Smyth alongside of the mother's name show conclusively that she was not in Virginia and that her whereabouts was unknown by her late husband's associates. It is evident that John Smyth, who was one of the closest friends of her husband, had heard that she was "slayne and dead;" but the crossing out of the line signifies that he later found that she was living and therefore obliterated the entry. If she had been living in Virginia, John Smyth would have known it. It is a safe conjecture that she had gone back to England after her husband's death, where in the usual course of events she would have re-

turned to her kin at Arrow in Warwickshire.

Be this as it may, the record explicitly states "Thomas Tracy their sonne returned for England." Exhaustive searches in the ancient records of England, in parish books, courts of chancery, English graveyards, and fugitive papers and letters in antiquarian archives, have failed to give one word that even mentions his return to England. Eminent American and British genealogists have gleaned the country to find an entry that would throw any light upon the existence of Thomas Tracy in England after he had departed from Virginia and "returned for England."

In 1636, there entered the town of Salem, Massachusetts, an Englishman by the name of Thomas Tracy. He had been in Watertown, Massachusetts, and came to Salem with references from citizens of Watertown. I here present Exhibit 12, which is a photograph of a portion of the book of the Salem, Massachusetts, Records, and contains this entry:

By the Towne represent, 2d of the first mo. 1636-7. p 38.

Tho: Trace Recd for Inhabitant vpon a Certificate from diuers of water Towne. And is to have 5 acres of Land. [which he may haue laid out when he hath a ticket from me that he hath paid me.] In short hand by the Town Clerk. pp 40-81.

De Lands or By the Towan repre-
rec. in inhabitants sentative the 23th
of the 11th mo.
Anno 1636

Mathew Waller Received for an Inhabitant fr a Certificate from mr Atherton haugh. pp. 40-81.

Thomas Trace ship Carpenter referred to Certificate. pp 40-81.

erased
[40 Die mensis [*9*] 10 1637. p 60.

It is agreed that the marsh & meadow Lands that haue formerly layed in comon to this Town shall now be appropriated to the Inhabitants of Salem, proportioned out vnto them according to the heads of their families. To those that haue the greatest number an acre thereof & to those that haue the least not aboue haue an acre, &

The Progeny of Saxon Monarchs in America

The Towne Records for Inhabitant upon a Cert for
 for Dinord of matter commo. - 1636
 and is to give 5 acres of land, 190 2 1/2
 James Standish by causing leave for S B for right for
 of four yers of the common weath by 99m, n^o 101's Caule
 if the Comms require to go well allow for money out
 but lot on the lot out
 Thomas Charwe for on Inhabit. of 22 may 88
 a term are set upon C. Ann 1636, n^o 101's Caule

IDENTIFICATION OF THOMAS TRACY IN AMERICA IN 1636

Exhibit 12—From Town Records of Salem, Massachusetts, in which his name is enrolled as an inhabitant—This document with much corroborative evidence discovers the missing son of William Tracy, who returned to England after his father's death in Virginia

to those that are between both 3 q'ters of an acre, etc.

When the list of those received allotments was written by Roger Conant he placed first the figure denoting the number in the family and then the name of the head of the family . . . the figures following the names denote the allotment. Thomas Tracy received 2 (quarters) or half an acre. p 101.

This Thomas Tracy, a ship carpenter, was received in Salem upon the "certificate of divers of Watertown."

The fact that he was accepted shows that his sponsors were responsible parties. Who were some of the leading residents of Watertown at that date? In 1636-7 we find among the estimable citizens one John Bridge; his wife, Elizabeth; his son, Matthew Bridge; another William Bridges; one John Smith, senior, John Smith, junior, Francis Smith, and a Thomas Smith—all well-bred Englishmen,

15. S
 Do Lande or
 In Inhabitants
 Bay of Boston n^o 101's Caule
 Anno 1636
 Malon n^o 101's Caule
 Certificate from m^r Abner Hunt
 81 Thomas Tracy by Carpenter offered to Certificate
 81 William by Carpenter offered for an Inhabitant
 of my self have a strong Lot
 81 John George by book of Laverius Long Wood
 for an Inhabitant

RECORD OF THOMAS TRACY AS A SHIP CARPENTER IN AMERICA IN 1636

Exhibit 13—From the Town Records at Salem, Massachusetts, and confirming the records that William Tracy of Hayles lost his entire estate in Virginia — His son, Thomas, was apprenticed as a ship carpenter with members of the Smyth family in New England

Unbroken Line of Descent from King Egbert

prominent in the community. The Smiths were wealthy shipbuilders and large land owners. John Bridge was the first deacon of the first church in Watertown and was a leader in the administration of public affairs.

The names Bridges and Smith have been frequently mentioned in the narration of the experiences of William Tracy of Hayles and Virginia. In Exhibit 3, it is shown that his grandfather, Sir Henry Tracy, married Elizabeth Bruges, also written Brugge, Bridge, Bridges, Brydger and Brydges, who was the daughter of John Bruges, the first Lord Chandos of Sudeley. In Exhibit 9, one John Bridges, a wealthy descendant of this old English family, offers aid to William Tracy about to sail for Virginia in his financial difficulties and speaks of him as his cousin. Throughout the entire financial embarrassment of William Tracy, in promoting his American interests, we find his "worthy" and "good" friend is John Smith or Smyth with whom he conducts a confidential correspondence. Exhibits 5, 6, 8, 9, 10, all show the close relations of the Tracys and Smiths. In Exhibit 7, it will be noted that it was John Smith who recorded the death of William Tracy, his daughter, the record of his wife, and the record "Thomas Tracy their sonne returned for England."

Then comes the silence of the English records in which Thomas, this young gentleman, is never mentioned, until in 1636 there appears in America one Thomas Tracy in a community with the Bridges and Smiths, persons of influence and wealth. The Smiths are rich shipbuilders; this Thomas Tracy is a ship carpenter. (See Exhibit 13.)

The genealogical evidence seems to me complete. Thomas Tracy of Watertown and Salem, is the missing son of William Tracy of Hayles and Virginia. The proof is much more conclusive than that required in many cases at law where circumstantial evi-

dence with less documentary proof frequently sends a man to his death. The identification is so strong that eminent genealogists and lawyers to whom I have referred my exhibits pronounce it conclusive.

By unimpeachable exhibits, many of which are in the handwriting of the parties in question, it is proven that William Tracy of Hayles and Virginia did not die without issue; that his son was in childhood; that his daughter was in maturity when through financial disaster and death of father and sister the boy was left destitute and "returned for England." That he did not remain in England is shown by the failure of the British records to mention him either in parish or politics, in property interests or trade, in marriage or death—not a word testifying to his existence in England, and this, coupled with the fact that he was the grandson of an honored knight, is evidence that he could not have remained in England.

About fifteen years after the death of William Tracy in Virginia there appears the record of a youth who has just learned the trade of ship carpenter in Watertown where the Smiths are wealthy shipbuilders, and where the Bridges are an influential family. Weighing the facts carefully, considering all the elements of the narrative, can there be any more reasonable conduct on the part of Thomas Tracy, who had been left destitute as the son of William Tracy who had lost all in the Virginia promotion, than to turn to his father's friends for assistance? These Smiths and Bridges in Massachusetts, branches of the old English families of friends and relatives of his dead father, knowing of the boy's plight, send for him to come there, and assist him to become self-supporting by teaching him the trade of ship carpenter in their own shipbuilding yards, and vouch for him when he starts out to make his own way in the world and goes first to Salem. The fact of his being a ship carpenter has

The Progeny of Saxon Monarchs in America

by some been considered to militate against the claim of his being of gentle birth; but with the explanation of the circumstances attending his early life it strengthens his identity and accentuates his independence of character and shows an honorable ambition to work out his own destiny as the true son of a true father. His second coming to America under the circumstances is very much to his credit. Instead of settling down at his home in the position of the "poor relative" he chose to give up the luxurious surroundings to which he was born and brave the privations and dangers of a pioneer in the new world, of which he must have had a very vivid recollection.

It is significant that the disappearance of the young son of William Tracy of Hayles and Virginia, is similar to the still more mysterious coming of the young man Thomas Tracy to Massachusetts, and these mysteries both occupy the same period of years. This period must be the connecting link that makes the boy the man. Exhaustive searches in Watertown and Salem, Massachusetts, and in Wethersfield, Saybrook and Norwich, Connecticut, prove that there is absolutely nothing in his American public record which taken by itself gives any clue to the place of his nativity, or whence or when he came to America.

Many searches have been made in England and America without positive results.

The movements of Thomas Tracy after he became an inhabitant of Salem are clear. That he became a man of strong character and a substantial citizen is shown by his long life of activity. The record of the division of the swamp lands in Salem (see Exhibit 14) show that Thomas Tracy was a single man in 1637, for it records him as a family of "1." He removed to Wethersfield, Connecticut, and came into the possession of land. He next removed to Saybrook, Connecticut, and shared in the first division of land there about 1639, and in the second division he was granted land adjoining his house. The name of his first wife, the mother of all of his children, is not known. He was probably married about the time he settled in Saybrook, where all of his children were undoubtedly born. The list of their births, if there was one, has not been found. He removed to Norwich, Connecticut, in 1660, with his seven children. As his wife is not mentioned it is probable that she had died. After his final settlement in Norwich, Connecticut, he was constantly employed in the public affairs. He was one of the first Deputies to the General Court and served twenty-seven sessions; he was Lieutenant of

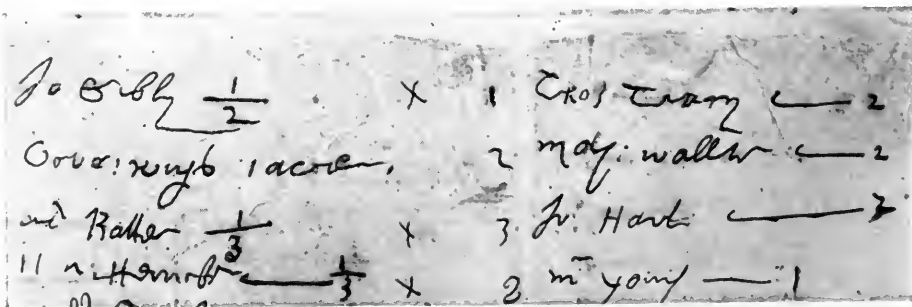

RECORD SHOWING THOMAS TRACY AS A LAND OWNER IN AMERICA IN 1637

Exhibit 14—From the Town Records in Salem, Massachusetts, in which Thomas Tracy is granted two quarters of an acre as an unmarried man's share in the allotment

Unbroken Line of Descent from King Eglbert

Dragoons and Commissary, etc., and his services qualify his descendants for the Societies of the Colonial Wars and Colonial Dames. While neither he or any of his descendants occupied the position of the chief corner-stone in the new nation, he and they did form a substantial part of the foundation and superstructure of the Connecticut facade.

Thomas Tracy married three times, for the record is given of his third wife, Mary (Foote) (Stoddard) Goodrich. She was the widow first of John Stoddard and second of John Goodrich of Wethersfield, Connecticut. Goodrich, as an inducement for Widow Stoddard to marry him, made an ante-nuptial agreement with her binding his heirs, if she survived him, to pay her four pounds per year during her life. She outlived him five years and the heirs forgot their obligations. There was a lawyer named Pitkin living in Hartford at the time and Thomas Tracy was a Deputy to the General Court there from Norwich, Connecticut. A letter indicates Tracy had a personal interview with Pitkin and engaged him to collect the claim and agreed to write him a statement of the claim. Pitkin brought a suit for the amount of the claim with interest and got judgment against the Goodrich estate and levied on a piece of land in Wethersfield which the Court ordered the Sheriff to deed to Tracy, which he received in satisfaction of all claims, September 2, 1685.

Mr Pitkin that which my wife haue re-seaued of her legacy that her — husband Goodrich Gave her dureng her life the first year shee resued fower pound the second year shee resued two pound Eighteen shillings and that is all that hau ben re-seued. Thomas Tracy.

Dyed Aprill, 1680. 5 years ²⁰⁻⁰⁰⁻⁰₆₋₁₈

13-2

This is the only sample of Thomas Tracy's writing extant.

He died in Norwich, November 7, 1685. His age at death is not given, and no record has been discovered that gives any clue to the date

of his birth. His children who shared in the distribution of his estate, were:

John, (Serg.) b. about 1642; m. Mary Winslow Jun 17, 1670.

Thomas, (Serg.) b. about 1645; m. Sarah ?

Jonathan, (Lieut.) b. about 1648; m. Mary Griswold Jul 11, 1672.

Miriam, b. about 1649; m. Ens. Thomas Waterman Nov —, 1668.

Solomon, (Dr.) b. about 1650; m. 1st Lydia Huntington Nov 23, 1676.

Solomon (Dr.) m. 2nd Sarah (Bliss) Sluman Apr. 8, 1686.

Daniel, b. about 1652; m. 1st Abigail Adgate Sep 19, 1682.

Daniel, m. 2nd Hannah (Backus) Bingham Nov 4, 1712.

Samuel, b. about 1654; unm. d. in Norwich, Conn Jan 11, 1693.

John Tracy was the richest of the family and a very large landholder in New London and Windham Counties, Connecticut. He inherited his father's carpenter's tools, which indicates that he was a builder. He did not take a very active part in the management of public affairs. Thomas and Jonathan settled in Preston, Connecticut, on land given them by their father, which was granted him by the General Court for assisting Uncas when he was besieged in his fort by the Naransets. They both took an active part in the town and church affairs, and Jonathan was town recorder and clerk from the organization of the town till his death, 1711. Solomon was the second doctor in the town and a lieutenant of the first train band, and Daniel was the Beau Brummel of the family—twenty-three ruffled shirts were enumerated in his inventory, and a sword and belt. As he did not belong to the train band, he must have used it as a dress adjunct and the insignia of the gentleman. The boy, Samuel, died young.

The American records of the early Tracys are voluminous and fairly complete; they present no perplexing problems and the lines are intact, but eminent genealogists have been at a loss to account for the boyhood of Lieutenant Thomas Tracy of Massachusetts and Connecticut, the forbear of a widespread American family.

The Progeny of Saxon Monarchs in America

The most notable of the exhaustive investigations in England was made by Judge Frederick Palmer Tracy of San Francisco, California, the first genealogist of the Tracy family. The eminent jurist was also a clergyman, and while preaching in Williamstown, Massachusetts, in 1844, his eyesight failed and he went abroad. When in England he visited Toddington and was received with all the courtesies due kinship by Lord Sudeley, the Right Honourable Charles Hanbury Tracy,



ARMS OF LORD SUDELEY IN 1838

Lord Sudeley was Charles Hanbury Tracy and inherited the heraldry of the royal line—Sir Thomas Tracy, Knight, inherited the shield and mask, front view and crest—William Tracy, Esquire, of Virginia 1620, from whom the Tracys in America descend, has inherited the shield, mask, profile and crest

Lord of Toddington Manor. In his searches there he did find a Thomas Tracy, a younger son of the same general family of Tracys, who was unaccounted for, and who was evidently of the same generation as our Lieutenant Thomas Tracy and a descendant of the Toddington family. As there was nothing to conflict with the assumption that he was the Thomas Tracy who came to America he thought he was very probably the same person. Judge Tracy communicated the result of his researches to Chancellor Walworth, who was then compiling his notable "Genealogy of

the Hyde Family," and he was so impressed with its importance that he presented the matter in full. From Ethelred down to and including Sir William Tracy, knight (24), who was one of the first of the gentry to adopt the reformed religion and willed his soul to God without the intervention of a priest, the line has not been broken, but from him down to Lieutenant Thomas Tracy it is erroneous and disproven.

The reason Judge Tracy could not find the right Thomas Tracy was because Thomas's father, William Tracy, left England without having either the births or baptisms of his children recorded in the local public records. The identification must be by circumstances, conditions, events, and irrefutable evidences that connect the boy with the man. The absence of this birth record led Britton in his account of Toddington to say that the William Tracy who married Mary Conway died s. p. (without issue), which misled the searchers by its falsity as a record. This book, "Historical and Descriptive Accounts of Toddington, Gloucestershire (England), the Seat of Lord Sudeley," by John Britton, F. S. A., 1840, dedicated to "The Right Honourable the Baron Sudeley" (Charles Hanbury Tracy), contains the substantially true lineage from Ethelred down to Lieutenant Thomas Tracy. The statement that William Traci was a natural son of King Edward is not confirmed by earlier and later authorities. There are other minor discrepancies.

The direct evidence, with its documentary bearings, its cumulative circumstances, and the mass of collateral and corroborative records, proves conclusively that the missing period in the lives of Thomas Tracy, son of William Tracy of Hayles and Virginia, and Thomas Tracy of Massachusetts and Connecticut, links them as one and the same person, connecting the

Unbroken Line of Descent from King Egbert

strange disappearance of the boy with the stranger appearance of the man. To weld these links in the chain still more firmly it is well to finally consider the narrative chronologically from its approximate dates.

In 1620, when William Tracy promoted the Virginia adventure his son was a mere child. It has been shown that if he had been far advanced in boyhood his father would have given him the male's precedence over his sister. It is not probable that he was more than ten years of age, and it is more probable that he was younger. To find a working basis for this chronological test an approximate may be placed at eight years of age.

It required from five to seven years' apprenticeship to learn the trade of ship carpentry, and it generally began as soon as the boy could prepare lumber and understand the construction of sea-faring vessels. If the eight-year-old missing Virginia boy was apprenticed to the trade he would have begun at about sixteen or seventeen years of age, and when he completed his time would have been about twenty-four years old. In 1636, Thomas Tracy, the ship carpenter at Salem, was an unmarried youth and must have been about twenty-four years of age, which is proven by the complete records of his later years. In 1637, when, according to the records, he was unmarried, he would have been twenty-five years of age. In 1639 (twenty-seven years of age), he was living in Saybrook, Connecticut, was married, and shared in the division of land. In 1660 (forty-eight years of age), he was in Norwich, Connecticut, and had seven children. He served twenty-seven terms in the General Assembly (there were two sessions per year), and died at seventy-three years of age in 1685.

If Thomas Tracy, the missing Virginia boy and scion of a gentle family, was eight years of age when his father promoted Virginia in 1620, he would

have been just seventy-three years of age in 1685, the recorded date and the approximate age of Lieutenant Thomas Tracy, the ship carpenter of Massachusetts and legislator of Connecticut, at the time of his death.

Choose your own approximate dates, based on the facts, and make your own computations from any conclusions you may find in the evidence, and the result is equally convincing.

I apply this chronological test to ascertain whether or not it will agree with the established facts. It proves them so mathematically accurate that all possibility of coincidence is removed. The genealogical link is welded. The chain from the Saxon Kings through William Tracy, governor of Virginia, and his son, Thomas Tracy of Virginia, Massachusetts, and Connecticut, is complete, and the descendants of Thomas Tracy in America are the progeny of the Saxon kings.

The lineage is supported by proof more tangible than that of many accepted assumptions of science. It has a greater preponderance of documentary evidence and relies less on faith and suppositions than much which we are required to accept from therapeutics, astronomy, dynamics, and even theology. I believe that in the days to come genealogy will become an established study in the science of heredity, but it cannot demand more formidable proof than the established sciences on which life itself depends.

With the lineage of Lieutenant Thomas Tracy, who died at Norwich, Connecticut, in 1685, established, and the mystery of his early life cleared, it is apropos in way of recapitulation to recall some of the near kinsfolk:

His Grandparents: Sir John Tracy, Knight, Lord of Toddington and Hayles Abbey; Anna Throckmorton, daughter of Sir Thomas Throckmorton.

His Parents: William Tracy, Esquire, of Hayles Abbey, Councillor of State for Virginia and Governor of Berkeley Hundred; Anne Conway, daughter of Sir

The Progeny of Saxon Monarchs in America

John Conway and sister of Lord Viscount Conway.

His Uncles: The Right Honourable, John Tracy, First Baron of Rathcoole; Sir Thomas Tracy, Grand Usher to the Queen; The Right Honourable, Edward Conway, First Lord Viscount of Conway Castle, "Lord President of His Majesty's Most Honourable Privy Council;" Sir Edward Bray; Sir William Hobby.

His First Cousins:

The Right Honourable, Robert Tracy, Second Baron of Rathcoole, M. P.; The Right Honourable, Edward Conway, Second Baron of Conway Castle, M. P.; Sir Thomas Conway, Lieutenant Colonel in the Army; Frances Conway, married Sir William Pelham, Knight; Brilliana Conway, married Sir Robert Harley, Knight; Heligawarth Conway, married Sir William Smith, Knight.

He had no Brothers; his only sister; Joyce Tracy, married in Virginia, Captain Nathaniel Powell, "a man of culture who kept an account of the occurrences in the Colony which were freely used by Captain Smith in his History of Virginia."

The royal lines from the Tracys, Conways and the Bridges shoot out into so many directions that the blood is found in many of the first families of Great Britain and America. It is a blood that has produced men in all lines of the world's activity,

that has been the maker of kings of an empire and conscientious citizens of a republic.

In using the term "Tracys in America" I refer of course to those who are descended from the first immigration. Other branches from immigrations later than those of William Tracy of Virginia in 1620 are not necessarily included in my discussion. For instance, there was one, Stephen Tracy, who came to Plymouth, Massachusetts, in the ship "Ann" in 1623, who has distinguished descendants through America, among them being General Benjamin Franklin Tracy, former Secretary of the Navy of the United States. It may be possible that there is a relationship, but my investigations have not yet allowed me to definitely settle this matter.

I inscribe these words to all those who are "looking forward to posterity with a knowledge gained in looking backward to ancestry," with the admonition of the great Edmund Burke who once remarked: "Those who do not treasure up the memory of their ancestors do not deserve to be remembered by posterity."

my Dittion that writing my wife gave
 nephew of her brother that is
 husband of your wife your son
 wife to first your son your son
 your son your son your son
 your son your son your son
 that you son your son Tracy

By 2 April, 1680 5 y^{ears}

20-06:0
 6:18
 13-2.0

Father of Biblical Culture in America

Reminiscences

of the First American Bibliotist

who Found Religious Thought under Dominion

of Iron-Bound Metaphysics and Disenthralled it from

its Slavery & First Contributions to Biblical Literature and

First School for Education to Ministry & Life of Moses Stuart, Born 1780

BY

JOHN GAYLORD DAVENPORT, D.D.

DEPUTY GOVERNOR OF THE ORDER OF FOUNDERS AND PATRIOTS AND MEMBER OF MANY LEARNED SOCIETIES

WHEN I was a very small boy I was driving with my father one day over the picturesque hills of historic Southern New England. As we approached a modest farmhouse, situated upon an elevation from which it commanded a broad view of the surrounding country, its front opening toward the sun-rising, there came from it a little old lady of thin face and bowed form who greeted us cordially and conversed with us in what we imagine to have been the characteristic language and tone of the rural New England of seventy-five or a hundred years ago. As we passed on I asked: "Who is that old lady?" "That is Aunt Betty Stuart," was the reply; "the sister of Moses Stuart." The answer was not especially illuminating, as I was as ignorant of "Moses Stuart" as of his sister, "Betty." It was the first time that I had heard the name which is now honored in the theological world as one of its choicest inheritances; a name that deserves to be perpetuated among those of all the pioneers who have led on to the light and culture of our advanced civilization.

First Stuarts in America and their Intellectual Attitude

A question of deep interest, long discussed but not yet answered, is how to account for the appearance of

men of unusual brilliancy and force of mind under conditions where neither heredity nor environment had seemed to lend any special aid. Moses Stuart's ancestors, for several generations at least, had been honest, God-fearing tillers of the soil, with apparently no broader outlook or clearer insight into truth than ordinarily pertained to those thus occupied. The family was probably of Scottish descent. Moses' great-great-grandfather, Robert Stuart, appears in Connecticut about 1660, where he married in 1661 Bethia Rumble of Stratford, and a few years afterward purchased one of the "home lots" that were laid out a little north of Long Island Sound. For a hundred and forty years their descendants seem to have remained for the most part within the limits of the town, where some of them are probably to be found to-day. Their great-grandson, Moses' father, Isaac Stuart, removed to the upper parish of the town, then and now known as "Wilton." On Christmas day, 1771, he was married to Olive Morehouse, and in 1773 they joined the Wilton Church. They occupied the then low-roofed, unpainted, shingle-covered farmhouse already alluded to, from which he went forth to serve the colonies in the War of the Revolution. He died in 1820, aged seventy-one. Mrs. Stuart survived him for twenty years, dying in 1840, aged ninety years, eight months and four days. Her grand-

Emancipation of Religious Thought in America

children regarded her as a remarkable woman. "She never seemed to grow old, even after she had passed eighty. Her senses were alert. There was no infirmity of years in her quick, keen intellect or her manner of expression."

Prospects of a Boy Born in America in 1780

To these worthy people were born four children, three of them girls. There was great joy in the father's heart, when, March 26, 1780, his son, Moses, was placed in his arms. He dreamed for him what seemed the noblest things. He would grow up to be his helper on the farm. The broad acres that he had wearily cultivated would become broader still and more fruitful. He would take his place in the church, and act his part with the freemen of the town, and be esteemed and honored as Christian and citizen as his predecessors had been. He had for him no higher ambition than that he follow the footsteps of his fathers, inheriting at the last his own worthy position and perhaps ennobling it by greater diligence and success.

But the father soon found that in this boy from whom he had hoped so much were elements which he had not anticipated and with which he scarcely knew how to deal. This modern Moses seemed likely to be anything but a "proper child," as judged by his father's ideals. There early developed in him an amazing and unaccountable fondness for books. The library of the farmhouse, carefully kept upon a shelf over the ample fireplace, comprised the standard works usually to be found under such circumstances among the closing decades of the eighteenth century. There was King James' version of the Bible, Baxter's "Saints' Rest," Doddridge's "Rise and Progress," the "Farmer's Almanac," and a few weekly newspapers. Somewhere in the house, possibly hidden away as not quite in keeping with the religious

conceptions of the day, was a book of ballads, the authorship of which is not recorded. Probably it was some collection of the "folk songs" of Scotland or of England, those charming utterances which, as has been said, "spring from the very heart of the people, and flit from age to age, from lip to lip of shepherds, peasants, nurses, of all the class that continues nearest to the state of natural men." Very likely the book had been handed down from generation to generation of the Stuart family. Whatever its exact character, it was found and appropriated by the boy, Moses, when he was but four years old, and read and re-read by him until he had every ballad by heart. The other books of the family were likewise mastered at a very early date by this precocious child, as were all the books of the neighborhood that could be borrowed. In one respect young Stuart fell behind the usual record of precocity. He did not undertake "Edwards on the Will," until he was twelve years old, but then he read it, according to Dr. Sprague, "intelligently and with the deepest interest." We hear no complaint from the father, but it must have been a disappointment and a grief to him to find that the son from whose co-operation he had hoped so much sadly lacked interest in the farm and its cultivation; that when he sent him out to plow, he would find him with the reins about the neck, a book in his hands and his mind upon the book, while the ploughing was left largely to the discretion of the horse! Or that when he had directed him to rid a field of its weeds, he would hours afterward discover a few of the more prominent offenders laid low, while the boy was comfortably curled in some shaded spot absorbed in the volume which he had carried with him to his task! In his father's dooryard, on the north side of the house, was a large rock upon which the youth is said to have been in the habit of studying in the early summer mornings. This is now sev-

Reminiscences of Moses Stuart—Born in 1780

eral inches below the sod, and reveals its location only in a time of drought, when the grass above it withers away for lack of earth!

Home-Life when the United States first became a Nation

Before, with young Stuart, we leave the old home, allow me to say a few words regarding it and to quote some of the traditions reported by aged residents of the town. The interior of the house is much the same as when he lived here, including the room in which he was born. The old stone chimney so familiar to him still stands, and several of the fire-places remain as they were when the house was built. A maple tree, south of the house, that was planted by his father, still grows green in the early spring and wraps itself in varied splendor in the autumn. The old well from whose "moss covered bucket" the boy drank is still in existence although unused. The oldest inhabitant of Wilton now living remembers distinctly the Stuart family. He states that Moses' mother enjoyed a great local reputation as a cook. Among her other achievements was that of making a famous Indian pudding every day. This she set over the fire on the hearth the first thing in the morning, and "it boiled and boiled until it was as light as a puff! When placed on the dinner table," as he relates, it "trembled all over from top to bottom." Perhaps this was from the well-grounded fear of being immediately devoured.

He relates that a man working on the farm once addressed Moses Stuart rather familiarly, after he had come into prominence. The mother rebuked him by saying, "Eben, honor to whom honor is due!" These glimpses of life in the long ago are interesting though homely. The man of whom we speak looked back to his early days in this old home as in many ways charming, and as having nurtured within him some of his most healthful tastes. His mother lived

until he was sixty years old and was always the recipient of his warm and reverent affection.

Educating an American Youth in Early Days of Republic

The afterward famous Wilton Academy, established by Hawley Olmstead of New Haven, had not as yet been opened, and the boy having exhausted the advantages of the district school was in his fifteenth year sent to Norwalk, where he enjoyed the instructions of Roger Minot Sherman, so noted in subsequent years as a jurist. The first intention was that he should simply perfect himself in English studies. But at once his teacher saw in him indications of unusual ability and advised him to prepare for college. "He began his Latin grammar," writes Professor Park, "with a characteristic impetus. In one evening he learned the four conjugations of verbs. In another evening he mastered the sixty rules of syntax. In three days the principles of the whole grammar were in his mind, and he found himself a member of a class which had devoted several months to the language. While pursuing the Latin and Greek classics, he attended also to the French language and literature. Several of his older schoolmates had devoted many weeks to the study of Telemachus. They ridiculed him for his attempt to recite with them at the very beginning of his study. He remained with them a day and a half, and was then transferred to a higher class!"

In May, 1797, he entered the class in Yale that was just completing its Sophomore year, he being seventeen years old. At this time he was especially fond of mathematics, but was neglectful of no part of his course. He showed then, as afterwards, an unusual eagerness for learning in its every department. He graduated in 1799, and a classmate writes: "At our commencement he had the salutatory oration, which was considered at that time the first appointment, and I

Emancipation of Religious Thought in America

do not suppose that a single individual of the class thought this distinction unmerited." During the year after his graduation he taught the academy on Greenfield Hill that was founded by Dr. Dwight when there pastor. Later he served as principal of the high school in Danbury where he began the study of law. Soon giving up teaching he devoted his entire time to preparation for his chosen profession, the law, studying in the office of Judge Chapman of Newtown. In 1802, at Danbury, he was admitted to the bar. It was felt by those who knew him that he was eminently adapted to win success and distinction in the legal profession. His mind was keen and logical, his memory of precedents unailing, while his constructive imagination enabled him to set an idea or an event before others in such a vivid light that they could but see its character and its bearing! His manner of speaking is said to have been such as to "give even common things the air of novelties." To the practice of law he looked forward with the utmost eagerness and enthusiasm.

However, one week before his admission to the bar, he was elected a tutor in Yale College. "My love of study," he wrote, "induced me to accept the office." He held it for two years, making his stay at Yale memorable for the enthusiasm with which he inspired his pupils. "His great power," said another member of the faculty, "was in making a class feel that something was to be done. Even Dr. Dwight, whose influence in this way was wonderful, did not in this particular surpass Mr. Stuart." Meanwhile his devotion to the legal profession did not diminish. He was continually looking for light upon its objects and methods. His favorite books were biographies of eminent jurists, and histories of great legal contests. But it was not among matters of this sort that he was to find his life work.

Choosing a Profession more than One Hundred Years Ago

If the origin of great minds in obscure places surprises us, the seeming insignificance of that upon which as a pivot such a soul may turn all its forces into new directions, is equally surprising. It was a time of peculiar interest at Yale. The preceding college year, that of 1801-2, had witnessed there a remarkable religious movement, such as had largely changed the spirit of the institution. At least one-third of the two hundred and thirty students had come to a new recognition of moral responsibility. And although the force of the movement had in a measure passed by, the atmosphere was still electric with spiritual vitality. This Moses Stuart may have felt, but as yet he gave no sign.

One day, very likely under the influence of the strict instruction of his home regarding the Sabbath, he called upon President Dwight and asked to borrow some book that would be suitable for him to read upon the holy day. The president gave him McKnight on the Epistles. At first he read it merely for its literary excellence, but as he went on he became absorbed in its religious instructions. It threw a light upon his motives and revealed them in such an aspect as was to him altogether new. From it a radiance emanated which seemed to bring into clearest relief the character of Him who is "God over all, blessed forever." He felt a new influence stealing into his soul, which his first impulse was to resist. That struggle for the supremacy of a human spirit, which is as old as the human consciousness, had been awakened within him. It continued for many days. But at length it ended in the complete surrender of himself, and enthusiasms, to Him whose right to rule he thus joyfully acknowledged. Of such a change the world takes little note, but doubtless it is that for whose sake all changes of

Reminiscences of Moses Stuart—Born in 1780

earth and sky, of time and circumstance occur.

Young Stuart at once looked out upon the world with anointed eyes and saw its affairs in new relations to privilege and duty. He loved the law, and it seemed to him scarcely less attractive now than before. In fact he spoke of it all his life as "a noble science." But in his horizon loomed that which seemed to him still nobler, in fact, so beautiful and glorious, that he felt that to it he must give his life. Theology rather than law should receive the unqualified devotion of his powers. With characteristic eagerness he set himself at preparation for the ministry, under the direction of President Dwight. "After reading," he says, "Dr. Hopkins' System of Divinity, a number of President Edwards' Treatises, several of Andrew Fuller's, a part of Ridgely's "Body of Divinity," and some of Mosheim's Ecclesiastical History, and a part of Prideaux's Connection, I was examined and licensed to preach by the neighboring Association of Ministers." He received his license from New Haven East Association in 1804. He had united with the college church in 1803. When I licensed, he had written but one sermon, a metaphysical dissertation to which a verse of scripture had been prefixed. With much care he wrote another, from the text, "My father, my father, the chariot of Israel with the horsemen thereof," and went forth into the world as a preacher of the gospel. His special equipment seems to us exceedingly small and inadequate, but back of the limited preparation was a great, glowing soul, eager to win dominion for its Lord. He traveled in Vermont, and having preached several times in the Church at Middlebury was invited to become its pastor. This invitation he declined. For a little he supplied to great acceptance the church of Dr. Rogers in New York city.

Intellectual Poise of the Scholar of the Last Century

In 1805, Rev. Dr. James Dana of the First Church in New Haven was temporarily disabled by the fracture of a limb, and Mr. Stuart was invited to fill the vacancy for a few weeks. Dr. Dana was a minister of the old school, refined, polished, classical in style, conservative, feeling it his duty, and his whole duty, to keep things as they were, content if the world grew no worse; a man who appreciated to the fullest extent the dignity of the ministry, and who bore his great office with exceptional stateliness and grace. He was a man of much ability, had graduated at Harvard at the age of eighteen and received a doctorate from the University of Edinburgh; was the man who forty-seven years before had been settled at Wallingford by the "old lights" of that day, and as a consequence the church, pastor, and all had been excommunicated by the "new lights" of the consociation. He had opposed revivals of religion, and with all his heart had protested against that so-called "New Divinity," the system of theological thought which now quietly reposes upon the top shelves of our libraries, like fossils in their cases, of interest to the student of progressive thought and a wonder to the curious. He repudiated the alleged "improvements" upon Edwards' theology, made by his successors. While in Wallingford he was so closely watched, lest his orthodoxy might be questioned, that he had acquired the habit of speaking with something of vagueness upon doctrinal points and apparently upon every point. He did not believe in the natural ability of men to repent under the preaching of the Gospel, and his sermons were not calculated to bring them to repentance. During his ministry of sixteen and a half years, five or six was the average annual addition to his church.

It is scarcely possible to think of a

Emancipation of Religious Thought in America

greater contrast to him than was presented by Mr. Stuart. He despised the old-time ideas of ministerial dress and solemnity of speech and demeanor. He sympathized with the progressive ideas of the new school of theological thought. There was in him the impulsiveness of the reformer. Regardless of externals and of unessentials, he desired to do what he could to make the world better. Inspired by a forceful love for Christ and humanity, he poured out his soul in a simple and earnest eloquence which strangely touched and moved. He did not speculate and question; he knew! All vagueness had flown from the pulpit of the First Church, and the most positive statement had taken its place. Religion, as he set it forth, was seen to be a living thing, and not the mere acceptance of a system of metaphysico-theological dogmas. His sermons grasped men's minds and filled them with new aspirations and a new realization of the importance of soul harmony with the spiritual universe.

Dawn of the New Thought and its Conflict with Conservatism

Many of the people of the First Church at once desired to secure him as an associate pastor; especially the younger portion of the congregation. But to this Dr. Dana very naturally objected. How could he consent to have at his side a man who ignored the things that with him had received the devotion of a life-time; whose views regarding the objects and methods of the ministry were entirely at variance with his own? In deference to the pastor's feeling Mr. Stuart refused the preferred position. But the matter turned out as those things are wont to do. Youth and vigor triumphed over age and conservatism. Dr. Dana's resignation was virtually sent in by the church; Mr. Stuart was called to the pastorate, and March 5, 1806, just as he was completing his twenty-sixth year, he was ordained pastor of the First Church in New

Haven. Dr. Dana, deeply wounded at heart, never entered the house of worship where for seventeen years he had officiated, during the pastorate of his successor. But he was present at the installation of Dr. Taylor who followed him and by special invitation of the society worshipped with the church during the remainder of his life.

Mr. Stuart's accession marked a new era in the history of the church. The petrified state of affairs that had existed for seventy years was effectually broken up. It was the dawn of springtime after a long and dreary winter. New life and beauty burst into view, and the air was filled with joy and song. Meetings for free conference and prayer that had been almost unknown became frequent. Even services by candle-light, which had been considered almost a scandal, were largely attended. Many who had thought that a decent morality with a regular attendance at church was all that could be expected of them, awoke to a new recognition of the reality and nearness of the spiritual world, and of the obligations which it laid upon them. Mr. Stuart's manner of preaching was solemn and impassioned. His clear, sympathetic voice arrested and held the attention of all, while his forceful language, his vivid illustrations, his sustained earnestness impressed every listener. His enthusiasm was communicated to his audience. He was what would be called in our day "a revival preacher." The common people and the learned alike hung with delight upon his words.

Dr. Porter, of Andover, Massachusetts, after hearing him, said: "This is preaching the glorious gospel of the blessed God." It is related that upon sacramental occasions his emotion often choked his utterance and his heart expressed itself in silent tears. During his pastorate of three years and ten months, two hundred persons were received into the communion of the church, only twenty-

Reminiscences of Moses Stuart—Born in 1780

eight of them by letter from other churches. There was evidently in him that force of intellect and depth of emotion whose combination is essential to the most effective preacher. As a pastor he seems to have been a model, devoting every afternoon of the week to his people. Professor Park relates that speaking of a negro once purchased as a slave by President Stiles, Mr. Stuart remarked: "That negro was the sexton of my church, and the most happy man, on account of his piety, whom I ever knew. I used to call on him oftener than on any man in my congregation, and it did me more good to hear him converse on his religious experience than any other man." The words are very suggestive as to the pastor's sympathy with humanity and willingness to be taught by the humblest.

If he had remained in the pastorate, as some of his admirers thought it his duty to do, his course would evidently have been full of joy to others and of blessing to the church of God. But what may perhaps be a broader work awaited him, and for it these New Haven experiences were a part of his training.

Beginning of Attack on Dogmas of Several Centuries

Until something less than a hundred years ago there was no opportunity in this country for specific and thorough preparation for the gospel ministry. Candidates for the sacred office, after taking a collegiate course, studied for a time with some more or less noted divine, reading under his direction, imbibing his theological opinions, constructing sermons for his criticism, undertaking something of pastoral work in a kind of apprentice way, under his supervision, and then, after receiving the "approbation" of the associated ministers going forth to the duties of their chosen profession. It was thus that Moses Stuart studied with Dr. Timothy Dwight; that many another studied

with Dr. Bellamy up among the hills of Litchfield County; that many a humble parsonage became a diminutive "school of the prophets." The method had its advantages, and also its evident defects. About the middle of the first decade of the nineteenth century it was felt by many broad-minded men that the demand of the times was for something more systematic in the training of ministers.

In the great development of theological speculation in the preceding century the tendency had been to drift away from the Bible as the only adequate source of religious truth. There was too great a fondness for accepting some dogmatic system, and then turning to the Bible to secure proof-texts for its maintenance and to force into the worthy service such as seemed reluctant to perform this duty. If a scripture passage ventured to stand squarely in the way by which a theologian would go, and obstruct his progress, he assailed it with the valor of a knight of old and if he succeeded in unhorsing it and leaving it helpless by the wayside, he marched on from the scene of conflict an acknowledged and applauded victor. But a new spirit was coming into the world of thought. The inductive philosophy was making its way. In the realm of natural science men were beginning to observe before theorizing. The phenomena of mind were being studied with a view to ascertain the principles that they embodied. Some dimly felt that the old methods in theology were outgrown and must be superseded. A greater effort must be made to know just the teaching of the Bible itself. Thus it might be possible to stem more effectively the tide which, in eastern Massachusetts, at least, was already setting strongly toward Unitarianism. The need of better rhetoric and more impressive elocution in the pulpit may have been recognized. The ministry must in all ways be better equipped if the New England churches were to maintain their ancient prestige.

Emancipation of Religious Thought in America

First School in America for Education for the Ministry

As a result of much thought and prayer and effort Andover Theological Seminary was established. It opened September 28, 1808, with four professors and thirty-five students, Dr. Timothy Dwight of Yale preaching the initial sermon. After one year the Reverend Eliphalet Pearson, LL.D., having resigned the chair of Biblical Literature, Moses Stuart was invited to fill it. The church in New Haven objected. "He cannot be spared," they exclaimed with one voice. "We do not want a man that can be spared," answered Dr. Spring of Newburyport. Mr. Stuart had read nothing of Greek but the New Testament and a few books of Homer's "Iliad." His knowledge of Hebrew was confined to that of a half dozen chapters of Genesis which he had painfully studied out without use of the vowel points. His fitness for the place was by no means technical. It consisted in his enthusiastic love for the Scriptures, his habit of whole-souled devotion to whatever task he set himself, and his ability so to teach as to inspire others with his glowing and tireless zeal. Conscious of his qualifications and of his deficiencies, he felt impelled to accept the position, and was inaugurated professor February 28, 1810. Although he was not yet quite thirty years of age, he had already chosen first the law, then the ministry. Both these had had their share in preparing him for that great work of his life upon which he now entered. In 1806 he had married Abigail, daughter of James and Hannah (Stoddard) Clark of Danbury.

Mrs. Stuart often, it is said, spoke of the contrast between New Haven, with its beautiful streets, its devoted church and circle of friends, and its literary opportunities, and Andover Hill as they went to it in the winter of 1810. It was bleak and desolate enough. A few wooden

houses had been built, but piles of debris and of building materials lay along the streets, and its theological professors and students were for the most part strangers and as yet uncongenial. She felt keenly the change. But her husband was too busy to be homesick. With characteristic energy he took in hand the work of his professorship. He found that for the study of Hebrew there were no facilities available. Himself mastering the subject as best he might, he wrote out lessons in the ancient tongue for his pupils, and lent them the manuscripts. In these the Hebrew characters were unpointed. Having pursued this method for a time, he determined that he must, should and would secure a printing press. This he did by personal solicitation. But when he had obtained it, there was no one who could so manage the Hebrew letters as to set the type, and although he taught the printers he was obliged to do a large amount of the work with his own hands.

First Hebrew Text Book Printed in America in 1813

In this manner he was able in 1813, three years after going to Andover, to publish a grammar of the Hebrew language, without vowel points, which was the first volume issued from that Andover press which has since been so fruitful and has become so famous. Of course it was the first book of the sort published in America. Not satisfied with it, he two years later published a second edition. Then he anew investigated its contents, and as he says, wrote "some of it three, four, and a small part seven and eight times over," and published the third edition. This attracted the attention of scholars across the sea. Professor Lee, of Cambridge University, said: "The industry of its author is a new matter for my admiration of him." In 1829 he had at his command fonts of type for eleven Oriental languages and dialects.

Reminiscences of Moses Stuart—Born in 1780

When commencing his work in Andover he often consulted Schleusner's Greek-Latin Lexicon, and in it frequently encountered German words which puzzled him. There was no one at Andover who could explain them. At that time scarcely more Americans studied German than now study Russian or Chinese. But Mr. Stuart felt himself challenged by the unfamiliar tongue to make himself its master. And so at no small expense he purchased an outfit for the study of German and giving himself to it with his accustomed enthusiasm, he made such progress that in a single fortnight he read the entire Gospel of John in that language. Some one presented him with a copy of Seiler's "Biblische Hermeneutic," and through this he was introduced to the whole range of German theological literature. He made a thorough study of the profound investigations of the German universities, and made use of them so far as they had a bearing upon his department. But more than this, he caught the free spirit of the German investigators, and while always reverent toward the Scriptures, he encouraged himself and his pupils in the most thorough and comprehensive examination of their teachings. Exegesis thus came to have a new meaning and a new importance. Certain texts which from time immemorial had been quoted in support of some dogma, were now shown to have no reference to the theme. The modern tendency to treat the Bible as literature was already in its inception. The movement had begun which was so materially to change the face of the theological world. And although Moses Stuart did not carry the matter to its broadest conclusions, there can be no question that he set it well on its way. "Before I obtained Seiler," he writes, "I did not know enough to believe that I yet knew nothing in sacred criticism." He often said in later years that he did not know how to begin the study of the Bible until he was forty years old.

Influence of German Philosophy on Religious Thought in America

But now there came to him a strange experience. Germany had been considered the favorite abiding-place of infidelity. While our ministers for the most part were ignorant of the exact results there arrived at, imagination pictured them as something entirely destructive of their sacred beliefs. And so when it was learned that Professor Stuart had become familiar with the works of German theologians and that his teachings in the seminary were imbued with the German spirit and moulded by German thought, considerable alarm was felt among the churches. It was believed that no good could possibly come from such contact with dreamy and vague theological thinking, evolved amid clouds of tobacco smoke under the stimulating influence of Germany's favorite beverage. A storm of censure and reproach swept over the conscientious teacher, and he was keenly alive to its force. "Unsupported," he says, "without sympathy, suspected, the whole country either inclined to take part against me or else to look with pity on the supposed ill-judged direction of my studies, many a sleepless night have I passed, and many a dark and distressing day, when some new effusion of suspicion or reproof had been poured upon me." But he wrote: "It is of little consequence what becomes of me if the teachings of the glorious gospel of the blessed God may come in its simplicity, power and authority before the public in a manner that will attract attention."

While the attacks were most severe an event occurred which entirely changed the situation. In May, 1819, Dr. Channing, in a sermon at the ordination of Mr. Sparks, afterwards president of Harvard, delivered in a Unitarian church in Baltimore, in his fascinating and powerful style set forth the claims of Unitarians in a manner to dishearten the timid, and

Emancipation of Religious Thought in America

virtually challenged orthodoxy to defend itself. The sermon was immediately published and was widely read and greatly admired. And the question was: Who in the name of the Lord of hosts could assail this intellectual giant and destroy his power? Moses Stuart stepped forth and by the aid of weapons imported from the land of the Teutons succeeded in crippling his strength. His published "Letters to Channing" greatly modified the sentiment in favor of Unitarianism that had been gaining ground.

Downfall of Prejudice and Bigotry after Hard Struggle

It is said that Dr. Lyman Beecher of Litchfield had prepared a sermon against the dangerous tendency of familiarity with German commentators and philologists, and was on his way to Andover with the intention of preaching it in the seminary chapel, when the "Letters" that had just been published, fell in his way. The consequence of reading them was that the well-meant sermon was consigned to the flames. And Dr. Beecher shouted, while he wept, "Thanks to God for the keen and powerful weapon Moses Stuart has been wielding." Those who had most severely criticised him acknowledged his learning. Those who had thought him mistaken in his devotion to German literature admitted their error. Professor Porter, who had not been altogether pleased with his course, said to him: "No, you could not have written that volume without your German aid. You are in the right in this matter, and your friends are in the wrong; take your own way for the future." Thus did Stuart win, though at great cost to himself, the liberty which his successors have so much appreciated and enjoyed. By his persistence in spite of the assaults of enemies and the frowns of friends he broke down the barriers of prejudice and gave to the American ministry all that was best in the results of German thought and research.

Through his influence Andover Seminary secured for its library a complete set of the works which have brought new and broader methods of study to American theologians. And yet it should be said that after the struggle he had made for light from across the sea, he was disappointed at finding in the writings of noted German authors so much with which he was out of sympathy, and which he regarded as destructive of the faith. To a friend he wrote: "Who is to stay the German flood that is coming in upon us, not through neology alone, but through such men as Tholuck, Neander and the like cast? Both of these have pronounced against the authoritative inspiration. Tholuck has written three articles against it, and Neander has abandoned it in his 'Life of Jesus.' What way is there to defend the Bible and make it understood again?" He sought to do it through the elaborate commentaries that he penned, upon the Epistle to the Hebrews, the Epistle to the Romans, the Apocalypse, the book of Daniel, the book of Ecclesiastes and the book of Proverbs, as well as by his daily teachings in the class-room.

After completing one of his volumes he wrote: "My little book on the interpretation of the prophecies is finished. I shall doubtless see a shower of arrows before long aimed at me by the prophetic romancers. No matter. My shield is thicker than that of Ajax for this combat. It is an eternal truth that a revelation from God must be intelligible, and must be vindicated from the abuses of those who make it the sport of fancy and wild imaginations. I have a piece now printing in the 'Bibliotheca' on some difficult passages in the Psalms. I have undertaken to bring before our public the half neological views of Hengstenburg, Neander and even Tholuck on Messianic prophecies and inspiration, and this has led me to say we must have our own commentators and theologians.

Reminiscences of Moses Stuart—Born in 1780

We must not, cannot depend on German manufactories. I say nothing of John Bull, for there is nothing to make a say out of it."

America's First Contributions to Biblical Literature

The publication of his books brought him into correspondence with Bible students in Germany, in Scotland, in England, and elsewhere, so that although he remained at home he lived the larger life which comes through contact with great souls in all the world. There is not time to follow this busy scholar through his years of toil. But his energy and devotion to his work knew no holiday. Between the years 1810 and 1852, besides many articles in the *Bib. Rep.* and *Bib. Sac.*, he published some thirty volumes, mostly of his own composition, a few of them translations from the Latin or German. These included the six commentaries already alluded to, Greek and Hebrew grammars, "Elements of Interpretation," "Rules for Greek Accent and Quantity," essays on "Future Punishment," "Mode of Baptism," "Immortality," "The Sabellian and Athanasian Methods of Representing the Doctrine of a Trinity in the Godhead," "Modern Doctrines of Geology," "The Old Testament Canon," "Conscience and the Constitution," and so forth.

The new light that has broken from the Word of God during the last half century has of course largely destroyed the value of some of these discussions. Some of Mr. Stuart's positions regarding inspiration and his estimate of the object and scope of some of the books of the Bible are not those of the theological professors of to-day. But to read one of his volumes is to be impressed with the extent of his research, and with the amount of erudition shown. One feels regarding Professor Stuart somewhat as he feels respecting Dr. Bushnell, a kind of pity that while in his eagerness for knowledge he came

so very near the modern conception of things, he yet just missed it. He must have possessed "the pen of a ready writer," or he could not have accomplished so much. Nothing that I have seen of his impresses one as written carelessly or without much thought and study. When sixty-seven years old he read all the tragedies of Aeschylus that he might find possible idioms and allusions throwing light upon the Bible. As a teacher he was pre-eminent. He touched and kindled the souls of his pupils with a sort of inspiration, stirring within them something of the enthusiasm which moved his own soul. Fifteen hundred came under his influence, and it is said that in a remarkable degree he stamped his own image upon them. His pupils found their place not only in the pulpit, but in many a literary institution at home and abroad. And thus his influence became world-wide.

Establishment of the Modern Conception of Moral Conduct

Professor Park, who knew him intimately, says: "The great work of Mr. Stuart may be summed up in a few words. He found theology under the dominion of an iron-handed metaphysics. For ages had the old scholastic philosophy pressed down the free meaning of inspiration. His first and last aim was to disenthral the word of life from its slavery to an artificial logic. He made no words more familiar to his pupils than 'The Bible is the only and sufficient rule of faith and practice.' In his creed the Bible was first, midst, last, highest, deepest, broadest. He spoke sometimes in terms too disparaging of theological systems. But it was for the sake of exalting above them the doctrines of John and Paul. He read the scholastic divines, but he studied the prophets and apostles. He introduced among us a new era of Biblical interpretation. The Puritan fathers of New England were familiar with the Greek and Hebrew tongues;

Emancipation of Religious Thought in America

but they never devoted themselves to the original Scriptures with that freshness of interest which he exhibited, that vividness of biographical and geographical detail, that sympathy with the personal and domestic life of inspired men, that ideal presence of the scenes once honored by our Redeemer, that freedom from the trammels of a prescriptive philosophy or immemorial custom. Because he had done so much and suffered so much in persuading men to interpret the Bible, not according to the letter, but the spirit, not in subjection to human standards, but in compliance with its own analogies, not by conjectures of what it ought to mean, but by grammatical and historical proofs of what it does mean, he has received and deserved the name of our patriarch in sacred philology."

"His mission," says Professor Park, "was to be a pioneer, to break up a hard soil, to do a rough work, to introduce other laborers into the vineyard which he had made ready. It is no common virtue which is honored in every farmer's cottage of the town where he has lived for two and forty years, and which is venerated by missionaries of the cross on Lebanon and at Damascus. I have heard him praised by Tholuck and Neander and Henderson and Chalmers, and by an Irish laborer, and a servant boy and by the families before whose windows he has taken his daily walks for almost half a century. His influence as a divine is to be widened and prolonged by the fact that on the hills and in the valleys around his dwelling, there is neither man, woman, nor child who has known him, who does not feel that he was an honest Christian man, an Israelite indeed in whom was no guile."

It is interesting to know the personal habits of a great man, and Mr. Stuart's daughter, Mrs. Sarah Stuart

Robbins, now living, revered and beloved at Newton Highlands, has contributed some facts in this connection which we are grateful to learn.

Of his personal appearance Dr. Wendell Holmes wrote: "Of the noted men in Andover, the one I remember best was Professor Moses Stuart. His house was nearly opposite the one in which I resided, and I often met him and listened to him in the chapel of the seminary. I have seen few more striking figures in my life than his, as I remember it; tall, lean, with strong, bold features, a keen, scholarly, accipitrine nose; thin, expressive lips; great solemnity and expressiveness of voice and manner, he was my early model of a classic orator. His air was Roman, his neck long and bare like Cicero's, and his toga, that is, his broadcloth cloak, was carried on his arm, whatever might have been the weather, with such a statue-like grace that he might have been turned into marble where he stood, and looked noble beside any statue in the Vatican."

It was a fractured bone that brought Mr. Stuart to the pastorate of the First Church in New Haven. It was another fractured bone, this time his own, that took him out of the earthly life. Slipping upon the ice he broke his arm and the strain upon his slender vitality was so great that he survived the accident but a few weeks. When he heard the hope expressed that his last sickness was unto life and not unto death, he replied: "Unto the glory of God, but unto death. I am prepared to die. O God, my spirit is in Thy hand. Have mercy, but Thy will be done."

On Sunday evening, January 4, 1852, while a severe storm was raging about his dwelling, he fell asleep. He was seventy-one years, nine months and nine days old. He had been a preacher forty-seven years, a teacher forty-one years, a theological professor thirty-eight years.

Reminiscences of Moses Stuart—Born in 1780

BY HIS DAUGHTER

MRS. SARAH STUART ROBBINS

NEWTON HIGHLANDS, MASSACHUSETTS

MY father brought into his daily life many of the habits acquired when he was a farmer's boy. He felt that every moment passed in sleep, after the most rigorous demands of nature were satisfied, was lost time. In summer at four, and in winter at five, he was astir, and the occupations of the day began. In summer his garden was his delight. To this he went when Andover Hill was still wrapped in sleep. To bring in the earliest flowers for the breakfast table, to surprise his family with some fine home-grown fruit gave him keen pleasure. Breakfast was often a silent meal. Then followed family prayers, and from family prayers he went directly to his study. When the door of this study was shut, the room was set apart from the surrounding world. Immediately every member of the family began to move about on tiptoe, and whatever words were spoken were uttered in subdued tones.

Out from this closed room came first the voice of prayer. Rising and swelling, often broken by emotion, there was a pleading, wailing cadence in his voice, touching to listen to, tender to remember. Then followed intoning passages from the Hebrew Psalms, and here the heart, mellowed and comforted by near intercourse with the Hebrews' God, found full utterance. Into every room of that still house, the jubilant words came ringing with their solemn joy. From the time this chanting ceased until eleven it must be a matter of the utmost importance that allowed a knock upon the study door.

Visitors, no matter from what distance, or of what social or literary standing, were all denied admittance.

Two friends of long standing desired him to marry them, and he agreed to do so provided the hour were after half-past eleven. They desired to be married at ten. "But that is in my study hour!" and neither love nor money could induce him to comply with their request, and another minister was secured.

He often repeated the sentiment of Heinsius: "I no sooner come into my library than I bolt the door after me, excluding ambition, avarice, and all such vices, and in the very lap of eternity, amidst so many divine souls, I take my seat with so lofty a spirit and such sweet content, that I pity all the great and rich who know not this happiness."

Even the ordinary housekeeping sounds must be made under protest. An unlucky fall, the slamming of a blind, loud voices, all were received with a warning thump from the study, or a pull at its bell. "I must not be disturbed."

Precisely as the clock struck eleven, there came an energetic pushing back of the chair and footstool, and the whole family drew a long breath of relief. Coming out of his room with a pale, weary face, the professor went at once to his customary exercise, never failing to be on the instant ready for his half-past twelve dinner with his family gathered about him. After dinner came the social hour of the day. If we had any request to make, any plans to proffer now was the time. Indeed it was the only time when home and its needs seemed to have any place in the professor's thoughts. Then a newspaper, a review or some book not connected with his work, was in his hand. Generally the reading continued until his lecture, which was delivered in the afternoon and occupied about an hour.

Emancipation of Religious Thought in America

This duty over, came the exercise again, the early tea, family prayers, and the evening was entered upon at the first approach of twilight. Study was never severe during these hours. Now he was willing to be interrupted, and often hailed the visit of an acquaintance as a godsend. Nothing gave him greater pleasure than to discuss with one of congenial taste the work upon which he was then engaged.

This until nine o'clock, but the moment the clock struck that hour, night with the time for needed rest had come. No guest who understood the regime of the student's life lingered after that hour, until the professor

became old and feeble. Then it was a great delight to him to have one of the students of the seminary come in and read to him, and the hour was often forgotten in the interest of the book. Light literature for the first time in his life he indulged in freely. With all his devotion to his specific themes he was keenly alive to every scientific discovery, and every advance in the political and literary affairs of the world. When the first train of cars passed through the meadows back of his house, he started from his seat at the dinner table, and clasping his hands together as if in prayer, said fervently: "Thank God! Thank God!"

In the cemetery at Andover, Massachusetts, where so much of sacred dust reposes, his body was laid to rest. Near him lies all that was mortal of Professor Phelps, who has indeed found "The Still Hour;" of Mrs. Phelps, his own daughter, who now knows life's "Sunny Side;" of Harriet Beecher Stowe; Dr. Leonard Woods, the long-time champion of orthodoxy; Professor Egbert C. Smyth, whose newly-made grave is grieved over by hundreds; and many another whose name is widely known. Upon a square prism of white marble, surmounted by a Greek vase, "erected in grateful remembrance by the alumni of the Theological Seminary," is this epitaph:

"A meek and earnest disciple; a fervid and eloquent preacher; a generous and cordial friend; a lover of all good learning; versatile in genius; adventurous in research; quick in acquisition; an enthusiastic and attractive teacher; devoting himself with patient and successful toil to the revival and cultivation of sacred literature; he is justly entitled to be called among the scholars of his na-

tive country, The Father of Biblical Science. The Word which he loved in life was his light in death. He now sees face to face."

Professor Stuart was the father of seven children, three sons and four daughters. The three sons graduated at Yale. One of them, Isaac William, became a professor in Columbia, South Carolina, but spent the latter years of his life in Hartford. He married a daughter of Stephen Bulkley of Hartford, and through her inherited the "Charter Oak" estate. The daughters were all well educated, two of them in New Haven, a third in Jacob Abbott's school in Boston, and the fourth in New Jersey.

Two of these daughters married Professor Austin Phelps, one of whom, Elizabeth, attained great popularity by her sketches of New England life. One of her books reached a sale of one hundred thousand copies in a single year. Her daughter, Mrs. Elizabeth Stuart Phelps Ward, has evidently inherited from her illustrious predecessors the mental keenness and brilliancy which gave them prominence and power.

Personal Letters of Pioneer Americans

Glimpses into Time-stained and almost Indecipherable Correspondence
Revealing the Strong Character, Conscientious Lives, Domestic Customs, Business Integrity and Courageous Hardihood of First Citizens of the Republic

This is an account of a tragedy in Early America written by Anthony Thacher of Massachusetts in 1635 to his brother, Reverend Peter Thacher of St. Edmonds, Salisbury, England. Both were sons of the elder Reverend Peter Thacher of Queen's Camel, Somersetshire, England, and contemplated coming to the New America, but the death of the wife of Reverend Peter Thacher, Junior, caused his change of plans so he sent his fifteen-year-old boy, Thomas Thacher, in his stead. The uncle and nephew landed at Ipswich, Massachusetts, and in 1644, Thomas Thacher was ordained into the ministry at Weymouth where he was pastor for more than twenty years and later installed as the first pastor of the historic Old South Church at Boston, Massachusetts

CONTRIBUTED BY

MISS C. C. THACHER OF ATTLEBORO, MASSACHUSETTS

ACCURATE TRANSCRIPT FROM ORIGINAL LETTER

I must turn my drowned pen and shaking hand to indite the story of such sad news as never before this happened to New England. There was a league of perpetual friendship between my cousin Avery and myself, never to forsake each other to the death, but to be partakers of each other's misery or welfare, as also of habitation in the same place. Now upon our arrival at New England, there was an offer made unto us. My cousin Avery was invited to Marblehead to be their pastor in due time; there being no church planted there as yet, but a town appointed to set up the trade of fishing. Because many there (the most being fishermen) were something loose and remiss in their behavior, my cousin Avery was unwilling to go thither, and so refusing, we went to Newbury, intending there to sit down. But being solicited so often, both by the men of the place and the magistrates, and by Mr. Cotton, and most of the ministers, who alleged what a benefit we might be to the people there, and also to the

country and commonwealth, at length we embraced it, and thither consented to go. We embarked at Ipswich, August 11, 1635, with our families and substance, bound for Marblehead, we being in all twenty-three souls, viz: eleven in my cousin's family, seven in mine, and one Mr. William Ellior sometime of New Barum, and four mariners.

The next morning, having commended ourselves to God with cheerful hearts, we hoisted sail; but the Lord suddenly turned our cheerfulness into mourning and lamentations, for, on the fourteenth of August, 1635, about ten at night, having a fresh gale of wind, our sails being old and done, were split, the mariners, because that it was night, would not put to her new sails, but resolved to cast anchor till the morning. But before daylight it pleased the Lord to send so mighty a storm as the like was never known in New England since the English came, nor in the memory of any of the Indians. It was so furious that our anchor came home, whereupon the mariners let out more cable, which slipped away.

An Account of a Tragedy in America in 1635

Then our sailors knew not what to do; but we were driven before the wind and waves.

My cousin and I perceived our danger, and solemnly recommended ourselves to God, the Lord both of earth and seas, expecting with every wave to be swallowed up and drenched in the deep; and as my cousin, his wife, and my tender babes sat comforting and cheering one the other in the Lord against ghastly death, which every moment stared us in the face, and sat triumphing upon each one's forehead, we were, by the violence of the waves and the fury of the winds (by the Lord's permission), lifted up upon a rock, between two high rocks, yet all was one rock, but it raged with the stroke which came into the pinnace, so as we were presently up to our middles in water as we sat. The waves came furiously and violently over us and against us, but by reason of the rock's position could not lift us off, but beat her all to pieces.

Now look with me on our distress and consider of my misery, who beheld the ship broken and the water in her, and violently overwhelming us; my goods and provisions swimming in the seas, my friends almost drowned, and mine own poor children so untimely (if I may so term it without offence), before mine eyes drowned and ready to be swallowed up and dashed to pieces against the rocks by the merciless waves, and myself ready to accompany them. But I must go on to an end of this woeful relation. In the same room whereat he sat, the master of the pinnace not knowing what to do, our foremast was cut down, our mainmast broken in three pieces, the fore part of the pinnace beat away, our goods swimming about the seas, my children bewailing me as not pitying themselves and myself bemoaning them, poor souls, whom I had occasioned to such an end in their tender years, when as they could scarce be sensible of death. And so likewise

my cousin, his wife and his children, and both of us bewailing each other, in our Lord and only Savior, Jesus Christ, in whom only we had comfort and cheerfulness, insomuch that from the greatest to the least of us, there was not one screech or outcry made, but all as silent sheep, were contentedly resolved to die together lovingly, as since our acquaintance we had lived together friendly.

Now as I was sitting in the cabin room door, with my body in the room, when lo, one of the sailors by a wave, being washed out of the pinnace was gotten in again, and coming into the cabin room over my back cried out, "We are all cast away, the Lord have mercy upon us. I have been washed overboard into the sea and gotten in again."

His speech made me look forth and looking towards the sea, and seeing how we were, I turned myself to my cousin and the rest, and spake these words—"Oh, cousin, it hath pleased God to cast us here between two rocks, the shore not far off from us, for I saw the tops of trees when I looked forth." Whereupon the master of the pinnace, looking up to the scuttle-hole of the quarter deck, went out at it, but I never saw him afterward. Then he that had been in the sea went out again by me and leaped overboard towards the rocks, whom afterwards also I could not see. Now none were left in the barque that I knew or saw, but my cousin, his wife and children, myself and mine and his maid servant. But my cousin thought I would have fled from him, and said unto me, "Oh cousin, leave me not, let us die together," and reached forth his hand unto me.

Then I, letting go my son Peter's hand, took him by the hand and said: "Cousin, I purpose it not; whither shall I go? I am willing and ready here to die with you and my poor children. God be merciful to us and receive us to himself," adding these words: "The Lord is able and willing to help and deliver us."

Personal Letters of Pioneer Americans

He replied, saying, "True cousin, but what His pleasure is, we know not; I fear we have been too unthankful for former deliverances, but he hath promised to deliver us from sin and condemnation, and bring us safe to Heaven, through the all-sufficient satisfaction of Jesus Christ; this therefore we may challenge of him."

To which I, replying, said, "That is all the deliverance I now desire and expect," which words I no sooner said, but by a mighty wave I was with a piece of the barque, washed out upon part of the rock where the wave left me, almost drowned; but recovering my feet, I saw above me on the rock, my daughter Mary, to whom I had no sooner gotten, but my cousin Avery and his eldest son came to us, being all four washed out by one and the same wave.

We went all to a small hole on the top of the rock, whence we called, to those in the pinnacle to come unto us, supposing we had been in more safety then than they were in. My wife seeing us there crept up into the scuttle of the quarter deck to come unto us; but presently came another wave, and dashing with the greater part of the quarter-deck unto the shore, where she was cast safely, but her legs were something bruised, and much timber of the vessell being there also cast, she was sometime before she could get away, being washed by the waves. All the rest that were in the barque were drowned by the merciless seas.

We four by that wave were clean swept away from off the rock also into the sea, the Lord in one instant of time disposing of fifteen sould of us according to his good pleasure and will. His pleasure and wonderful great mercy to me was thus: standing on the rock as before you heard, with my eldest daughter, my cousin and his eldest son, looking upon and talking to them in the barque, when—as we were by that merciless wave washed off the rock, as before you heard, God in his mercy caused me to fall by the stroke of the wave, flat

on my face, for my face was towards the sea, insomuch that I was sliding off the rock into the sea, the Lord directed my toes into a joint of the rock's sides, as also the tops of some of my fingers, with my right hand, by means whereof, the wave leaving me I remained so, having in the rock only my head above the water, when on the left hand I espied a board or plank of the pinnacle. And as I was reaching out my left hand to lay hold on it, by another coming over the top of the rock, I was washed away from the rock, and by the violence of the waves was driven hither and thither in the seas a great while, and had many dashes against the rocks. At length, past hopes of life, and wearied in body and spirit, I even gave over to nature, and being ready to receive in the waters of death, I lifted up both my heart and hand to the God of Heaven (for note), I had my senses remaining perfect with me all the time that I was under and in the water, who at that instant lifted my head above the top of the water that so I might breathe without any hindrance by the waters.

I stood bolt upright as I had stood upon my feet, but I felt no bottom, nor had any footing for to stand upon, but the waters. While I was thus above the water, I saw by me a piece of the mast, as I suppose, about three feet long, which I labored to catch into my arms. But suddenly I was overwhelmed with water and driven to and fro again, and at last I felt the ground under my right foot, when immediately, whilst I was thus groveling on my face, I presently, recovering my feet was in the water up to my breast, and through God's great mercy, had my face unto the shore, and not to the sea. I made haste to get out but was thrown down on my hands with the waves, and so with safety crept to the dry shore, where, blessing God, I turned about to look for my children and friends, but saw neither nor any part of the pinnacle where I left them as I supposed. But I saw my wife about a

An Account of a Tragedy in America in 1635

butt length from me getting herself forth from amongst the timber of the broken barque. But before I could get to her she was gotten to the shore. I was in the water after I was washed from the rock before I came to the shore, a quarter of an hour at least.

When we were come each to the other we went and sat down on the bank. But fear of the seas' rolling and our coldness, would not suffer us there to remain. But we went up into the land and sat us down under a cedar tree, which the wind had thrown down, where we sat about an hour almost dead with cold. But now the storm was broken up, and the wind was calm, but the sea remained rough and fearful to us. My legs were much bruised, and so my head was; other hurt I had none, neither had I taken in much quantity of water, but my heart would not let me sit still any longer, but I would go to see if any more were gotten to the land in safety, especially hoping to have met some of my own poor children; but I could find none, neither dead nor yet living.

You condole with me my miseries who now begin to consider of my losses. Now came to my remembrance the time and manner how and when I last saw and left my children and friends. One was severed from me sitting on the rock at my feet, the other three in the pinnacle. My little babe (ah, poor Peter) sitting in his sister Edith's arms, who to the utmost of her power sheltered him from the waters. My poor William, standing close unto them, all three of them looking ruefully on me, on the rock, their very countenances calling unto me to help them, whom I could not go unto, neither could they come at me, neither would the merciless waves afford me space of time to use any means at all, either to help them or myself. Oh, I yet see their cheeks, poor silent lambs, plead pity and help at my hands. Then on the other side to consider the loss of my dear friends, with the spoiling and loss of all our goods and provisions; myself

cast upon an unknown land in a wilderness, I knew not where nor how to get thence. Then it came to my mind how I had occasioned the death of my children, who caused them to leave their native land, who might have left them there, yea and might have sent some back again and cost me nothing; these and such like thoughts do press down my heavy heart very much.

But I must let this pass, and will proceed on in the relation of God's goodness unto me in that desolate island on which I was cast. I and my wife were almost naked both of us, and wet and cold even unto death. I found a knapsack cast on the shore in which I had a steel and flint and powder horn. Going further I found a drowned goat; then I found a hat and my son William's coat, both of which I put on.

My wife found one of her petticoats, which she put on. I found also two cheeses and some butter driven ashore. Thus the Lord sent us some clothes to put on and food to sustain our new lives, which we had lately given unto us, and means also to make a fire, for in an hour I had some gunpowder which to mine own (and since to other men's) admiration was dry. So taking a piece of my wife's neckcloth, which I dried in the sun, I struck a fire, and so dried and warmed our wet bodies, and then skinned the goat, and having found a small brass pot we boiled some of her. Our drink was brackish water, bread, we had none.

There we remained until Monday following, when about three of the clock in the afternoon, in a boat that came that way, we went off that desolate island, which I named after my name, Thacher's Woe, and the rock Avery, his fall, to the end that their fall and loss and mine own, might be had in perpetual remembrance. In the isle lieth buried the body of my cousin's eldest daughter, whom I found dead on the shore. On Tuesday following, in the afternoon, we arrived at Marblehead.

First News of an American Victory

This is an account of the joy that reigned throughout America on the news of victory, told by an eye-witness, Stanton Sholes, who was born March 14, 1772, married Abigail Avery on March 14, 1793, and died February 7, 1865, at Columbus, Ohio, in his ninety-third year—Accurate transcript from Original Manuscript

CONTRIBUTED BY

SARAH ELIZABETH SHOLES NIGHMAN

GREAT-GRANDDAUGHTER OF THE NARRATOR

Bayonne, New Jersey

THE writer of this short Sketch was born in one of the British North American Colonies (as his fathers were) some years before the Revolutionary War Commenced and slept in Juvenile darkness till the thunder of the Revolution burst on the young mind and called him to his feet in 1775 so that his first view on the elements of time were crimsoned with the commencement of the Revolutionary War. For me at this time to commence my worlds tour when the elements of nature were lighted up by the torch of a bloody war and the voice of distant thunder rolling over these young Colonies but we had a Washington and a Franklin that could call down fire from heaven to consume the sacrifice.

Wonderful age this for the young stranger to shape his future course. Dark were the elements that covered the path of the young, but goodness and mercy by the hand and as years passed away his mind expanded more to the cause of the war and this bloody strife. My Father and four brothers older than myself all warmly engaged in this war. The town of Groton my birthplace and New London had been suffered to remain in peace till the sixth day of Sept. 1781 when at daylight there was discovered twenty four British anchored at the mouth of the river three miles below the city. They soon landed eight hundred troops on each side of the

river. Arnold commanded one division and led them to the City and burned it. The other division marched upon Groton side of the river to attach Ft. Griswold on Groton Heights. This bloody strife and massacre of the garrison of Ft. Griswold was in sight of my home, there my eyes saw and my ears heard the death strife and struggle of that ill-fated garrison.

I will not attempt a description of the next days scene, it was awful to all that could stand within hearing of this slaughter house. The town that gave the young stranger being and opened its arms to receive him to its bosom is now in lamentation and mourning and sack-cloth its daily uniform. I had one brother in the Fort he was one of the few that escaped with life. At this time my Father was in the army and two Brothers and one in a priviteer at Sea. This sixth day of Sept. 1781 was a dark day for Groton more than forty widows and two hundred orphans were left in a few hours to mourn the loss of husbands and fathers. The writer had two Uncles and seven Cousins killed in the Fort.

In October was heralded to us the joyful news of the surrender of Lord Cornwallis and his whole army to the combined armies of America and France. Oh! how my young heart leaped for joy. In spring of 1782 Sir Guy Carleton arrived in New York bringing the cheering news of the

The First News of American Victory in 1782

probability of a peace being soon restored between the two countries. When Sir Guy arrived with his news the people were filled with great joy some sang, some cried, some danced, some prayed, and others drowned sorrows with a good mug of flip. It was a mighty great joy in our own way so that 1782 passed away with but little blood shed and the year rolled away in much quiet. In the spring of 1783 intelligence arrived that articles of peace had been signed by Great Britain.

In the independence of the United States, in the general joy all party animosity seemed to be forgotten and mingled in one exultation. Throughout the country all was cheer and good feeling toward each other, and when they met they met on a level, and as freemen and a heavenly joy beaming in every face. How beautiful nature now at the end of the war and how dark and gloomy before. With heavenly joy they met the change and natures God adored in high praises.

Now peace reigns over the land everyone commences as if he had begun in a new state or some new inheritance gained, but in great peace and love did the young nation commence its proud stand beside the nations of the earth. In Novr. of this year the British troops left New York for Great Britain. In June of this year 1783 my Father returned from the Army and in Oct. two Brothers all poor and destitute. These three served in the Revolutionary War over eleven years. My Father had served several years in the British army against the French and Indians before and at the time Buebeck fell into the hands of the British. The fourth of Oct. 1789, My Father died and now with the consent of my mother I commenced the sea faring business and in this I continued for many years. It was a hard life to manage yet I was very fortunate in all I undertook.

In all this I must acknowledge God's guardian care over me in all my wanderings by land and sea not to make mention of his mercy and goodness in the special providence of God in the saving of my life and while I followed the sea. I continued the Sea faring business till 1803 at that time the war between Great Britain and France almost swept the American Commerce from the sea, for this cause I quit the Sea and returned back into the State of New York and after a few years moved into the state of Pennsylvania and bought a farm on the Ohio river twenty two miles below Pittsburg; here I remained till 1812. I was then commissioned a Captain in the U. S. Artillery and soon entered the service of my country and remained in its service till July 1814. I then settled up with my government and in a year or two entered trade and in this business continued many years and was extremely fortunate in my trade.

In 1836 I wound up my business and then rambled about till 1842 then settled down in the city of Columbus, Ohio, where we now live in great peace and love up to this 1859. Now what watchfulness my heavenly Father has had over me in all my rambling by Sea and land. In my early life He took me up and bare me on his hands through the war or the scene of the Revolution, and through the dangers of the sea my life boat, and in war my shield and safeguard.

Oh! wonderful Providence! When He first called me to light there was no nationality to this great people but now in this my day and time have stretched their arms like seas and become a mighty nation all in my day or single lifetime. Oh, the wonderful improvements! A few brave squatters combined to draft a Constitution that should bind these thirteen Colonies under one government and laws was no small work in these days.

Life Stories of Gallant Americans

The Lanes—Cavaliers of the South

In the Wars of Early America

BY

MRS. LOUISA KENDALL ROGERS

Barnesville, Georgia

THIS is the story of one of the most distinguished and influential of the early settlers of Virginia, Maryland and the Carolinas.

The family is said to be collaterally descended from Sir Ralph Lane who sailed from Plymouth, England, in one of the vessels fitted up by Sir Walter Raleigh in 1585. Captain Lane was a brave, daring young cavalier, the son of Sir Ralph Lane of Orlingbury, whose wife, née Parr, was first cousin of Catherine Parr, the favored queen of Henry VII. Sir Ralph Lane, junior, was the first colonial governor appointed on American soil. Although history asserts that the colony was broken up by the Croatan Indians at Roanoke, it is generally believed some of the party drifted into North Carolina and assisted greatly toward building up the commonwealth of the state. Sir Ralph Lane died in 1604, while on a visit to Ireland, so it is not positively known how long he remained in America.

During the summer of 1618, two years before the Pilgrims and Puritans landed in America, Joseph Lane (supposed to be a descendant of Sir Ralph Lane) came from England to Jamestown, Virginia, which was settled in 1607 by Captain John Smith and his London Company, who established a code of laws for the colony. From there this family of Lanes found their way to Roanoke and Halifax, North Carolina. There was born Joseph Lane, junior, the true lineal ancestor of a noted family of

American patriots whose descendants are scattered throughout all the states, from the storm-washed coast of the Atlantic to the middle Pacific and from the great lakes to the Gulf of Mexico. The old family records handed down for many generations have grown to vast proportions, and several volumes might be filled with thrilling accounts of their daring exploits during the Revolution, the Mexican War, The War between the States, and the late Spanish War.

Joseph Lane of 1710 married Patience McKinne, daughter of a wealthy Scotch immigrant who owned vast quantities of land in what was then known as the Caledonian regions. Their sons were Joel, Jesse and Joseph Lane. They moved from the vicinity of Halifax on the Roanoke to a comparative wilderness in Johnson County where Raleigh, the capital of North Carolina, now stands.

Colonel Joel Lane was a statesman "to the manner born," and during the War for Independence was at onetime its presiding Justice.* Throughout the entire conflict with Great Britain he served with fidelity in many important civil stations. He not only represented his county as senator for fourteen years, but his name appears in "Colonial Records" as Lieutenant Colonel, 1772. His dwelling still stands, a landmark of the Revolution, and was considered at the time a rare specimen of architectural elegance. He was a member of the first Provisional Congress which met at Hills-

*See Court Records of Wake County.

The Lanes—Cavaliers of the South

borough twenty-first of August, 1775, in defiance of the proclamation of Governor Martin, issued twelve days in advance, forbidding such an assemblage.

Governor Martin accused them of being "*rebels and traitors*," against the king and his government, denouncing the resolves of a set of people styling themselves a "Committee of the County of Mechenburg," who traitorously declared the dissolution of the laws, government and constitution of the country, the preposterous enormity of which cannot be adequately described and abhorred.

At any rate, in defiance of this libelous proclamation, the brave and patriotic convention was determined to build up a republic in America. Consequently, the General Assembly of this "most rebellious of provinces," amidst the darkest hours of the Revolution, met at the house of Joel Lane in June, 1781, and elected Thomas Burke, one of the most eminent of the men of revolutionary renown, the third governor of the state, Colonel Lane at the time being senator of Wake. Wishing to establish the capitol in his own vicinity, on the fourth of April, 1792, he conveyed to the state one thousand acres of land. Subsequent to this arrangement for Raleigh, he presented six hundred acres for the site of the University, as an inducement to locate the institution near the capitol. Thus did this grand old patriot lend his wealth and influence toward the upbuilding of the American Republic, well deserving a monument to his memory, although it has never been reared.

His sons served their country, and at the present day one of his great, great granddaughters is State Regent of the Daughters of the American Revolution of Tennessee.

Joseph Lane, the second brother, was a member of the Tribunal of the First Court in North Carolina, which was held fourth of June, 1771. He married Ferebe Hunter, reared a large family and died 1798. One of this

family, Lieutenant-Colonel Joseph Lane, received large grants of land for his services during the Revolution and is mentioned in history.

Jesse Lane, the third brother, was born 1733, married Winefred Hycock and reared a happy household of fifteen children, all of whom lived to a good old age, contributing of their "basket and store" to the formation of a permanent government. He is the ancestor of thousands of America's noblest men and women, among them General Joseph Lane of Oregon, called "The Marion of the War with Mexico," who was candidate for vice-president of the United States, governor of Oregon, and senator eight years.

Jesse Lane served his country with the Third North Carolina Continentals and with his sons bravely fought in the battles of Guilford Court House, Cowpens, and King's Mountain.

General Ferguson of the British Army was a brave, fearless officer and at first eyed the motley crowd of American "rebels" with scorn, not deigning to think that they really meant to attack him, but when his practiced eye reconnoitered the situation he chafed like a lion at bay.

The Americans were divided into three sections, Campbell and Shelby leading the center, Sevier and McDowell the right, and Cleveland and Williams the left. Ferguson met the attack with the bayonet, and as there was not a bayonet among the poorly equipped Americans, they were at first repulsed. Soon the British were attacked from another quarter, and Ferguson's fury knew no bounds when he saw that the party he had driven down the hill with the bayonet were renewing the attack with more vigor than before. He rode from point to point, leading his men with desperate bravery, but soon fell to the ground pierced by a well-aimed rifle ball.

The American loss was only about thirty men, while the British lost one

Life Stories of Gallant Americans

hundred and fifty killed and nine hundred prisoners. At this battle of the mountain, Jesse Lane, his son John (who was father of General Joseph Lane of Oregon), Charles Lane, another son, and his sons-in-law, gallantly threw their whole strength into their efforts for independence, so that the battle of King's Mountain, notwithstanding the smallness of the numbers engaged, put a new phase on the struggles of the South. When the news of the entire destruction of Ferguson's army reached Cornwallis he was made to tremble for his own safety. The heroes of King's Mountain having so well accomplished their plans, returned in triumph to their homes and delighted in handing down to their descendants a true history of their victories. They scarcely realized the immense service they had rendered the United States, but the value of that service was soon to be realized by General Greene who had been appointed commander at the South, and who, whether fighting or retreating, was to justify the confidence by which he had been chosen for this post by General Washington.

The little town of Halifax is one of the oldest in North Carolina, and not only its first settlers, the Lanes, were brave and courageous, but all of its whole population. It was the first to

celebrate the Declaration of Independence after it was signed in Philadelphia, and it was there Cornwallis and his army were quartered several months, as was also General Tarleton. William Hooper, one of the signers of the Declaration, though put down as a delegate from Wake, came from the eastern part of the state.

A late historian who had occasion to refer to the history of Raleigh in connection with the triumphant march and occupancy of the city by Sherman's army, speaks of Colonel Joel Lane as the progenitor of the notorious "Jim Lane" of Kansas. This is a mistake. They are not of the same family. General Joseph Lane, who won fame and renown in Mexico, Governor Henry S. Lane of Indiana, General Alfred H. Colquitt of Georgia, "The Hero of Olustee," Lieutenant-Governor Robertson of North Carolina, Governor David Swain of Chapel Hill, and Honorable George W. Lane of Alabama, District Judge of the United States, were all cousins, great nephews of Colonel Joel Lane, and grandsons of Jesse Lane. The latter moved to Elbert County, Georgia, in 1786, and died in Missouri, 1806, leaving descendants throughout all the states of the union, who, like the three brothers, are noted for their uprightness, patriotism and integrity of character.

THE HISTORIAN

BY

HERBERT HUGHES

Galt, Ontario, Canada

Into dim and dusty archives of the past,
In buried cities, 'mongst rude pictured
stones,
'Mid ruined temples and long-mouldered
bones,
He delves, nor shudders at the problem
vast.
He hears the ancient warrior's trumpet
blast,
He mounts the mediæval monarchs'
thrones.

He spans all ages and surveys all zones,
He sees the Then and Now, the First and
Last.
And, comprehending all, he weighs, divides,
Unraveling myths and fables from their
maze,—
Between conflicting annals he decides;
Traditions melt before his searching
gaze.
And then he paints the picture of the tides
Of all past life, for this and future days.

FAIR COOLING SPRAY, O LOVELY SEA!

BY

DR. FREDERICK H. WILLIAMS

Fair, cooling spray, oh, lovely sea!
How maiden coy thy changing mood;
To-night thou'rt sweet with smiles for me,
Scarce yestertide I vainly wooed
Thy fretful features for a smile,
Naught could for me one thought beguile.

Yet must I love thee, soft-eyed sea,
Whate'er may be thy changing mood;
Or hast thou smiles or frowns for me,
Forever am I strangely wooed
To cast me by thy pulsing side,
Wistful to wait thy changing tide.

But when thou donn'st thy garments blue
To bask beneath yon sunlit sky;
When lace-white clouds flit over you
And bright-hued birds amid them fly;
Thou turn'st on me thy sweetest smile
And all thy ways my thoughts beguile.

Or when, come eve, the god of day
Stoops low to wreath his hairs with
thine,

Swift raptures o'er thy ripples play,
Thy wanton waters blush like wine:
While waving willows by thy side
Waft love-soft whispers o'er thy tide.

When night her dusky mantle sends,
As sleep sows silence o'er the sea;
When distance into presence blends
All things commingling magicly,
I see thy spirit, yearning rise
Communing with the bending skies:

Yes, must I love thee, blue-eyed sea!
Whate'er may be thy changing mood;
Thy wondrous self constraineth me,
And all that mighty brotherhood
Of life, thou broodest on thy breast
Impelleth me to love and rest.

ON THE HILLTOPS—BY JOSEPHINE CANNING

I close fast the portals behind me
Where dwelleth contention and strife;
Where trouble embitters the fountains
That spring from the rivers of life.
I close fast the portals behind me
And wander in spirit afar
To hills standing blue in the distance,
With naught that can hinder or mar.
How cool the fresh air on the uplands;
How bright the blue sky overhead;
How fragrant the pine and the balsam,
Whose odors like incense are shed.

How restful the sound of the brooklet
That, murmuring, runs to the sea;
How wondrous the gift of God's blessings
So bountifully given and free.
Thus, unto the soul that is weary
With conflict and question and doubt,
How sweet is the peace on the hilltops
And all the fair country about.
Alone on the heights where God dwelleth
So close to the heavens above,
There only do war and dissension
Give place to the Angel of Love.

Country Life
in America



ALONG THE ROCK-BOUND COAST



THOUSANDS OF LAKES LIKE MIRRORS
REFLECT THE NOONDAY SUN

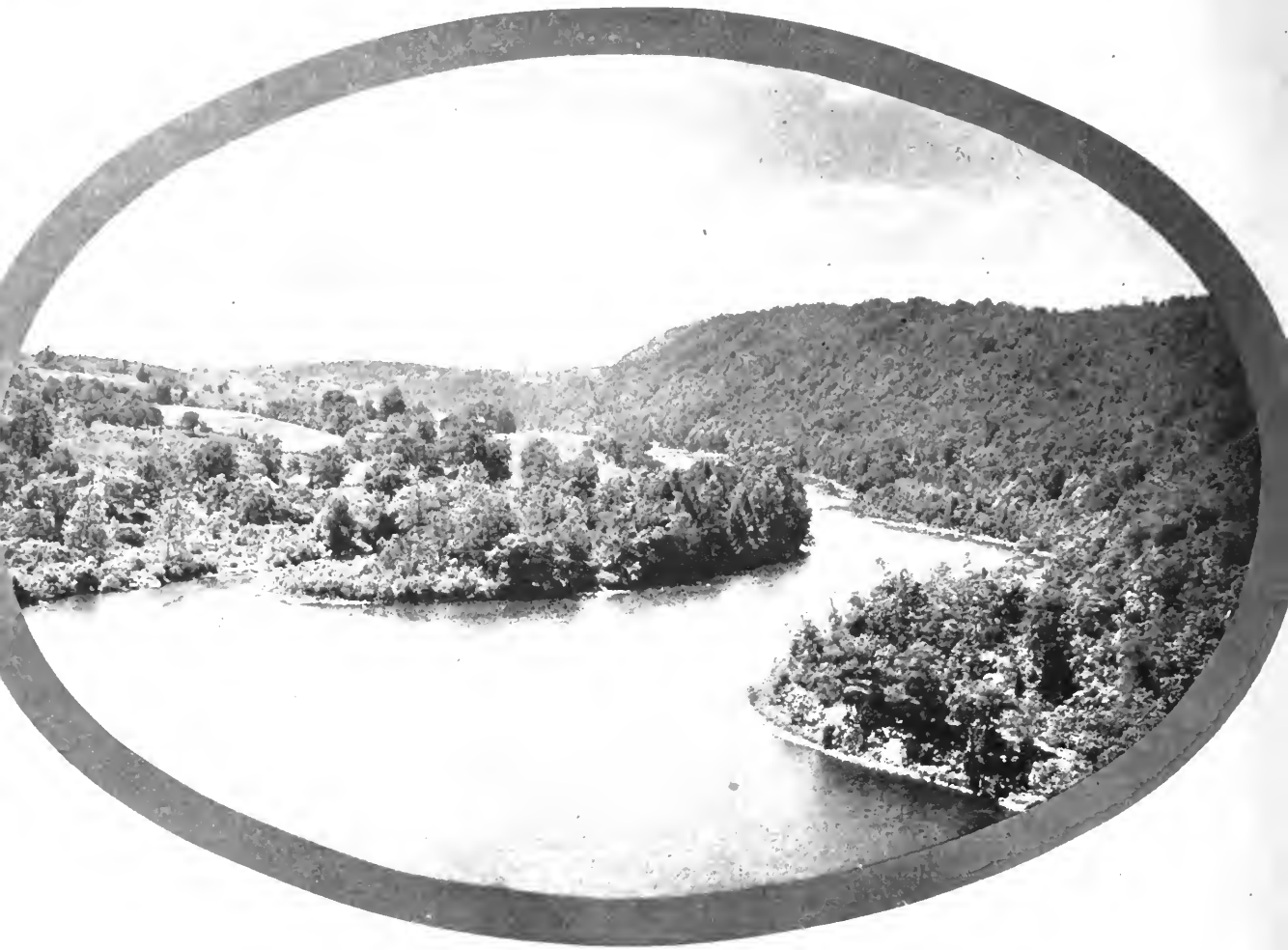

THE RUSH OF THE RIVERS TO THE SEA



FROM THE FOREST-CLAD HILLS

Country Life
in America



SUMMERTIME IN THE LAND OF REST

ESTATE OF A "WELL-TO-DO" VIRGINIAN IN 1674

TRANSCRIBED FROM THE ORIGINAL BY

DR. JOSEPH LYON MILLER,

GRANDSON OF THE SEVENTH GENERATION

Thomas, West Virginia

"AN INVENTORY OF ALL & SINGULAR THE GOODS AND CHATTELS OF MR. AMBROSE FFEILDING GENT: OF WICKOCOMOCCO HALL DEC'D. APPRAYSED & VALUED UPON OATHE BY US THE SUBSCRIBERS BY VERTUE OF AN ORDER OF NORTHUMBERLAND COUNTY COURT DATED YE 17TH DAY OF MARCH 1674"

YE SERVANTS

	£	s	d
1 Servt man—Wm Farecloth 3 yeares to serve.....	6	00	00
1 Do Thos: Holmes 2 Do Do £5 1 Servt Boy John Sonpin 7 yrs. £6...	12	00	00
1 Do maide Jane Farecloth 3 Do Do £2 1 Do Maide Jane Cooper 2 Do £1..10.....	3	10	00
1 Negro man Ned £15. 1 Do Symon £20 1 Do Boy Chubb £7.....	42	00	00
1 Do woman Jude £10. 1 Do girl Prosee £5 1 Do Boy Ran £10.....	25	00	00

YE STOCK

1 ² Black Cow & Caff 24 / 1 pyde cow & Caff 24 / 2 red Cows 40 / 1 Bull 22 /	5	10	00
1 White Do 18 / 1 Red Do 20 1 Pr Oxn 48 /	4	06	00
5 Yearling heyffers £2..16 7 Do Steeres £3..04.....	6	00	00
4 two Yr old steers 4 1 old mare 40 / 1 bay mare 85 / 1 white horse 70 / ..	13	15	00
1 black Horse 46 / 1 two yr. old filly 50 / 2 yerlings att 18 /	5	05	00
30 Hogges & pigs £6..4 All the whole Stock of Fowls 18 /	7	02	00

YE HALL PARLOUR

1 Ovell Tabel 12 / 1 turkey Worke Carpet 18 / 5 pictures 10 /	2	00	00
7 Turkey worke Chears 30 \ 3 Rusha leather Do 22 /	2	12	00
4 Family portraits unpraysed. 1 Tapstry Couch 17 \	17	00	
1 Court Cubbard 10 / A pcell of old small Bookes 28 /	1	08	00
A pcell of old large bookes 33 / 1 large Bibel 18 /	2	11	00
1 ould Silke Cheare 8 / 1 Dutch Carved Chare 10 / 1 pr brass And Irons 13 /	1	11	00
1 pr. old Silver Candle Sticks 47 / 1 small tabel 3 /	2	10	00

YE PARLOUR CHAMBER

1 ould Leather Cheare 8 / 1 ould silke do 7 /	15	00	
1 Greate Bedd & cord wth Curtaines & Vallaines lines wth Silke, teasters, & Damaske & Silke Counterpayne.....	10	13	00
1 Feather bedd, bowlsters, pillows & two blankettes.....	4	10	00
1 Carved Chest wth locks and keys 25 /	1	05	00
2 pr. Linnen Sheetes 18 / 3 Do Pillowbers 6 /	1	04	00
2 pr Canvis Do 8 / 2 Do Canvis Do 2 /	10	00	
1 pewter Bason Ewer & Chamber pott 5/6.....	05	06	
1 Looking Glass 3/6 1 brass Candelstick 2 /	05	06	
1 Warming pann 1/2 1 Ivory Combe / 10 1 Cloath brush / 5.....	02	06	

YE GREAT ROOME

	£	s	d
1 Long Dining Tabel 17/ 1 small Tabel 2/8 1 Serving Do /5.....	1	00	08
14 Rush Chears 14/ 1 Large ould bottle Case & bottles 3/8.....		17	08
1 Ould chest 4/ 1 small Do 3/ 1 pr. and Irons 10/.....		17	00
1 Large Damaske Tabel Cloath & 22 Napkins.....	2	10	00
3 Ould canvis Do 6/ 13 Do Do 4/.....		10	00
4 New towelles 4/ 7 ould Do 2/.....		06	00
1 Cubbard 7/ All ye Earth 7/ Glasse Ware 15/4.....	1	02	00
31 old pewter ware att 5d p. p. 101/2 new Do att 12d p. p.....	1	03	00
1 Silver Tankard wth ye Ffeilding Armes on it.....	5	07	00
1 Do small Do markt "A. F." 38/ 1 Silver bowle 40/.....	3	18	00
1 Do Dram Cupp 5/ 1 Do Sacke Do 10/ 1 Do Tumblr mkt wth ye Armes 12/.....	1	07	00
11 Large Silver Spoones 22/ 8 small Do Do 8/ 1 Silver Salt 5/.....	1	15	00
21 Alchimy Do 2/7 17 Quart bottles 2/8.....		05	03
3 brasse Candl stks 3/ 1 brass kittle 7/.....		10	00
1 old Fowling Peace 9/ 1 muskt 17/ 2 Pistolls 12/.....	1	19	00
2 Rapere 1/ 1 hanger 12/ 1 brass mortar & pestil 4/4.....	1	16	00

YE CHAMBER OVER YE HALL PARLOUR

1 Leather Trunk 5/ 1 Chest 7/ 1 ould Do wth locke 5/.....		17	00
1 beddstid cord Curtains, Vallaines, blanket & Rugge.....	3	18	00
1 Feather bedd, bowlster & pillowes.....	3	14	00
1 small tabel 1/3 2 rush chears 2/ 1 ould Chamber pott.....		03	11
Looking Glasse 2/8 2 horne combes 3d 1 ink horn 5d.....		03	04
1 pr Canvis sheetes 6/ 2 pr pillowbers 1/ 5 ould sheetes 7/ & pillowbers 2/.....		09	05
1 pr Virga. Shewes 1/3 1 pr Rusha Leather shewes 2/8 1 pr Gloves 1/2		04	11
1 Broad cloath Gt Coat 18/ 1 Do short lind wth silk 14/ 1 ould cloath suit 15/.....	2	07	00
2 pr britches 7/ 1 pr silk Stuckings 2/3 2 pr Cotton Do 1/3 1 peri- wigge 15/.....	1	05	00
1 ould hatt wth a hole in it 2/2 3 shirts and a pcell of ribband 4/.....		06	02
1 pr Silver buckls 2 pr Do Buttons 1 Do Watch & seale 1 Do Tobaky box..	3	15	00
1 plaine gold Ringe 1 Sealed Do Do 2 mourning Do.....	2	02	00

YE CHAMBER OVER YE PARLOUR CHAMBER

1 Bedd, cord, feather bedd & furniture 82/ 1 other Do., Do. Do. 78/.....	8	00	00
1 ould trunk 5/ 1 ould Chest 4/ 1 Tabel rod 3 stools 1/ 1 pcell old Cloathes & other trumpery 8/.....		18	10

YE OUTE KITCHIN AND SERVTS ROOME

1 pr. and Irons 2/ 1 Large Iron pott 7/ 1 small Do 5/ 1 other Do 3/ 1 ould Do 1/3.....		18	00
3 pr pott Racks 5/ 2 Do lids 1/ 1 flesh fork 6d 4 spitts 3/4.....		09	10
3 ould Tubbes 1/6 2 new Do 2/ 5 Cyder casks 10/ 2 Cow belles 1/2...		14	08
1 Ox Chaine & rings 2/10 a pcell old Iron trumpery 1/8.....		04	06
a pcell ould Carps & Coopers tooles 6/ a pcell old bottles 2/8.....		08	08
1 Greate Kittle to containe 40 Gals. 18/ 1 small brass Do 1/.....		05	00
1 Drip pan 1/ 3 ould tin pannes 1/6 4 frying pannes 2 ould 2 new 5/.....		06	06
1 pr Stillards 4/ 1 brass skimer 1/ 1 ould tabel & form.....		08	00
2 Sad Irons 1/8 2 old Spinningy wheeles 8/ a pcell old Rugges & blanketts 5/.....		14	08

£222 05 05

The remainder of this inventory is missing, but probably listed the supply of grain, hay, etc., on hand and the plantation tools kept in out-buildings

Contemporary Thought in America

"The Press of the Republic is the Moulder of
Public Opinion — the Leader and Educator"

COLORADO

THE AMERICAN PEOPLE MUST LEAD VAN OF PROGRESS

EDITORIAL WRITER
IN THE DENVER REPUBLICAN

Statistics printed by the department of commerce and labor covering the period in the history of this country from 1800 to the present time, reveal the wonderful growth which the United States has made; and from the information thus presented one may form an idea of the conditions existing at the beginning of the last century, when the country was young, although it had already attained respectable rank among the nations of the world. The fact that the population per square mile is nearly twenty-eight at the present time, whereas in 1800 it was only six and a half, is in itself remarkable, but the extent of this growth will be more fully appreciated when it is considered that the area, exclusive of Alaska and the island possessions, is nearly three and a half times as great now as it was in 1800. The American people have not only made many inventions in which the world at large has shared, but they have developed a wonderful capacity to utilize their own devices as well as those of other countries. What the future has in store no man can conjecture, but we know that the productive power is increasing in an accelerating ratio. Every decade reveals a remarkable advance over the one next preceding, and we have every reason to believe that the century upon which we have entered will witness a more remarkable growth than the one just closed. The enormous increase during the last one hundred years of the per capita wealth is evidence of rapidly improving conditions for the people, which we have no reason to question will continue. The fact that the per capita wealth is nearly four times as great now as it was in 1850 is an indication of this growth. Apart from the individual possession of wealth, the condition of the people has been most wonderfully improved through improvements affecting the manner of living, especially in urban communities. Systems of public water works, lighting systems, facilities of transportation, and greatly improved sanitation have made the lives of people of moderate means more luxurious in many respects than those kings and princes a hundred years ago. In all this the American people have shared to a more remarkable degree than the inhabitants of any other part of the world.

OHIO

CIVILIZATION'S GREAT WORK IS IN ITS BEGINNING

EDITORIAL WRITER
IN THE TOLEDO BLADE

"Of approximately one hundred million horses in the world," says O. P. Austin, of commerce and labor, "eighty million are found in the temperate zone, and nearly all among Occidental people, while the remaining twenty million, scattered principally throughout the tropics, are largely employed in service of temperate zone visitors or residents, and are but feeble representatives of that noble animal as he is known to the people of Europe and America.

"The United States and Canada have one horse for every three and a half persons; in South America, one for every seven; in Mexico, one for every twelve; in Japan, one for every thirty-three; in Turkey, one for every forty; in the Philippines, one for every fifty; in Africa, one for every one hundred and fifty, and in India and in China, probably one for every two hundred. Throughout the tropics and the Orient are scattered approximately three million camels, ten million donkeys and twenty million water buffalos, or carabao, with oxen utilized to some extent almost everywhere and millions of men, especially in the Far East, doing the work of the horse. The freight motor vehicle is being used successfully in New Mexico and Arizona, Porto Rico, Central and South America, Egypt, Turkey, India, Japan, South Africa and almost all other countries, in many of which, with the thermometer well above the one hundred mark, the horse cannot live, but where the heavy freight motor can pull its string of trailers with almost the capacity of a small railroad train. The tropics," said Mr. Austin, "and the Orient are the great undeveloped sections of the world. Within the tropics are millions of square miles of productive land and billions of dollars' worth of products for which the temperate zones are calling loudly. In the Orient are hundreds of millions of patient workers and for their products the Occident is increasing its demands. The inability of each of these sections to respond to our demands has been because of the absence of some available method of transportation."

Contemporary Thought in America

PENNSYLVANIA

AN ATTEMPT TO SOLVE THE RIDDLE OF THE PLANETS

EDITORIAL WRITER IN
THE PHILADELPHIA INQUIRER

Thirty years ago it was generally assumed that the planets were inhabited by beings similar to ourselves, and this largely because of the popular book written by Richard Proctor. The book was not intended to be conclusive; in fact, only opened the question, and before his lamented death the author felt that he had proved nothing. In the storm of disapproval which came from astronomers popular opinion veered to the other side, and it has for some time been held that there is no evidence that the planets are occupied.

Then came Dr. Wallace, the co-discoverer with Darwin of the principle of natural selection as the prime factor in evolution, and one of the most honored scientific men of the day, who still survives. He wrote a book to prove not only that our planets were not inhabited, but that all the available evidence went to show that of the hundred millions or more of suns which we call stars, and which may have planets, not one of the latter could be populated by human beings. He held that the earth was at or near the center of the universe, and the sole abode of animal life, in which he curiously agreed with the ancient Greek philosophers and the medieval, as well as some modern theologians. Professor Percival Lowell showed by careful observations conducted in Arizona that the "canals" of Mars not only exist, but give evidence of design. Last year he published a book in which he thought he had substantially proved that the canals were artificial, and that life on Mars was proved as clearly as anything so practically undemonstrable could be. This deduction was not entirely satisfactory, and the new expedition sets forth in the hope of securing better observations from the summit of the Andes.

In viewing the planets it is not so much a large telescope as clear atmosphere that is needed, since the largest telescopes magnify the variations of the atmosphere and becloud the objective. It is hoped that from the height of some fifteen thousand feet an almost undisturbed vision can be procured. Lowell holds that the laws of chance are totally against any such accidental arrangements of canals as he has found. If his expedition confirms his views, a great gain will be accomplished.

INDIANA

AMERICAN SCIENTISTS BELIEVE JAPANESE ARE CAUCASIANS

EDITORIAL WRITER IN
THE INDIANAPOLIS STAR

The basic stock of the Japanese is Ainiu, or Aino, aboriginal in the north and east of the islands; the secondary stock, the Yamatos, were not pure Mongolians, but, on the contrary, of Caucasian origin, and the comparatively recent Mongolian importations have affected but slightly the national type according to Dr. N. Gordon Monro, who has been studying the terra cotta figures recovered by excavation in Japan from a remote antiquity. He has devoted many years to this work, and finds that these figures, in general, exhibit a distinctly Caucasian appearance, and the aristocratic type of Japanese preserves these features to this day. The beau ideal of the artists and poets of Japan indicates a prototype of Iranian (Persian) or other Semitic affinity. "The Mongolian element in Japan," says Dr. Monro, "was an imported, not an original stock." He also declares that "the leaven of Ainiu," that is, of white blood, "is present in the Japanese composite to a greater degree than is apparent." Of the Caucasian origin of this basis stock there is no doubt whatever. It is well known that the Ainu people, of whom some thirty thousand are now left in the northern island of Hokkaido, are white men, in essential respects similar to the people of Southern Russia. Their language is also related to the people of the Asiatic Aryan group, the successors to the ancient Sanscrit, from which the Greek is also derived. Dr. Monro shows that the Yamato people, the parents of modern Japan, were also partly or wholly of white origin. Dr. David Starr Jordan, formerly of Indiana, but long the famous president of Stanford University, gives his full adherence to Dr. Monro's opinions. The conclusion of science seems to be, therefore, that the Japanese race is primitively one of the white races allied to the Persians and the Hebrews and not to the Chinese. To the military, economic and industrial aspect of American relations with Japan the fact is not, perhaps, important; but it certainly deserves emphasis among that large element of our population who rely upon color and other racial peculiarities to determine the worth of a man to the world and his right to the earth and air.

Contemporary Thought in America

MARYLAND

WILL MAN HARNESS POWERS OF SUN, MOON AND TIDE

EDITORIAL WRITER IN
THE BALTIMORE SUN

Perennial interest attaches to the idea of utilizing tides as sources of electric power, and the *Electrical Review* mentions some promising enterprises. One of these is based on the plan of creating two reservoirs or basins which communicate with the sea by means of control valves. One of these basins is filled at high tide and the other emptied at low tide. The water is allowed to flow from one to the other, driving turbines connected to generators. A study of the tides has shown that in this way continuous power can be depended upon for about ten hours a day.

In England three important installations are now being considered. One of these is at Chichester, where the estuary may be easily divided into two basins approximately equal in area. It is estimated that under ordinary tides about 6,800 horse-power may be obtained, and under unusually high tides, 13,800 horse-power, for ten hours a day. At Menai strait a dividing dam will give power, owing to the difference in time for the tides at the two ends of the strait and to the difference of twenty-eight feet in the height of the tides at the two ends. At Bristol, by having two reservoirs, a fall of thirty feet will be obtained, giving two hundred and forty thousand horse-power. On the coast of Brittany and Normandy the difference between high and low tide is 4.0 feet. In the bay of Fundy, on this continent, the rise and fall are still greater. The pull of the moon on the sea produces immense effect, measured in horse-power, and it naturally vexes this utilitarian age to see so much power wasted. The same may be said of the daily waste of the sun's heat, especially in rainless countries. By the time our forests are consumed and our coal mines are exhausted—as they must be after a while—inventive genius will doubtless have found a way of harnessing the neglected powers of the sun and moon.

Twenty American institutions of learning, from the Smithsonian Institution down, have been granted rights under the act of Congress of June 8, 1906, to make archæological investigations in this country, provided they conform to reasonable regulations as to the use of such antiquities as they discover, and aid the government in saving valuable ruins from vandals. *Boston Herald*.

NEW JERSEY

UTILIZATION OF INVENTION OF GENIUS OF MAN

EDITORIAL WRITER IN
THE PATERSON MORNING CALL

In five Eastern states, with Illinois, Ohio and Indiana, is manufactured more than ninety per cent of all the electrical apparatus turned out in the United States. These states are New Jersey, Pennsylvania, Connecticut, Massachusetts and New York. According to a bulletin issued by the Census Bureau last week the growth of this business in the five year period from 1900 has been remarkable. In 1905 there were seven hundred and eighty-four establishments engaged in the manufacture of electrical machinery, apparatus and supplies, with a capital of \$174,066,026. Of these seven hundred and eighty-four establishments, New Jersey, Pennsylvania, Connecticut, Massachusetts, New York, Illinois, Ohio and Indiana reported six hundred and thirty-one. The figures in total capital was greatest in Pennsylvania, and the capital and value of products of the other eastern states follow: New Jersey—capital, \$18,457,821, and products, \$13,803,476; Massachusetts—capital, \$12,735,427, and products, \$15,882,216; New York—capital, \$30,643,167, and products, \$35,348,276. The remarkable growth in the use of the telephone is illustrated by the fact that in 1905 the value of telephonic apparatus manufactured was nearly \$16,000,000 as compared with approximately \$10,500,000 in 1900. Illinois was the great center of this industry more than one-half of the total products being from that state.

Theoretically at least, arbitration as a means of settling international disputes is no new thing. In 1623 Emeric Cruce suggested an international tribunal at Venice—a court that should be world-wide. China and other Eastern nations were to be represented in like manner as China and Japan are represented at The Hague at the present time. Even in the twelfth century the learned Grotius had in his mind a forecast of the present conference. He advocated the utility and necessity of the Powers forming some kind of a body in whose assembly the quarrels of each might be terminated by the judgment of others not interested. *New York Press*.

THE LAST LEAF

The key of Yesterday
I threw away,
And now, too late,
Before tomorrow's close-
locked gate

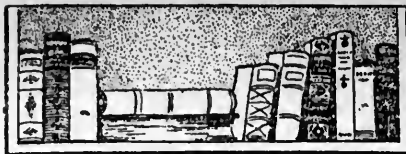

Helpless I stand—in vain to
pray!
In vain to sorrow!
Only the key of Yesterday
Unlocks tomorrow!

EDITORIAL COMMENT

This last page of the book brings us again to retrospect. We are in a world of books, and crowding upon us from every direction, rising from beneath and falling from above—it is books, books, books! There are books philosophic, books polemic, books psychologic, books didactic, and books pedantic. We are living in a great democracy of books in which the renegade of liberty-loving print and the highest literary morals jostle one another in the public mart; where direst literary poverty lies down with intellectual riches. And each finds its affinity in the hearts and minds of men; there is not one but finds some day and somewhere a loyal friend in mankind. Good Dr. Van Dyke says that Art for Art's sake is heartless, and soon grows artless; Art for the public market is not Art at all, but commerce; Art for the people's service, for the diffusion "of joy in widest commonality spread" is a noble, vital, permanent element in life. This is the heart and soul of these pages—public service; "seeking to strengthen, deepen and improve the relations of American literature to the American people, that it may really enrich the common life, promote the liberty of the individual from the slavery of the superficial, and wisely guide and forward men in the pursuit of happiness."

Literature has never before meant so much as it does in this democratic age, when education is being widely diffused and the struggle between good and bad reading, between great books and trivial, has become a question of serious discretion. It takes all kinds of books to make a world just as it takes all kinds of men—and as books, like men, have characters there is nothing within the range of human strength and human frailty that will not be boldly reflected upon their pages. Every man owes it to himself to drink into his life the purest and sweetest that the earth can offer him. Dr. Channing once remarked that there is but a very minute portion of the creation which we can turn into food and clothes, or gratification for the body, but the whole creation may be used to minister to the sense of beauty—the ocean, the mountains, the clouds, the heavens, the stars, the rising and setting sun, all overflow with beauty; the universe is its temple, and those men who are alive to it cannot lift their eyes without feeling themselves encompassed with it on every side. When men discover beauty it will radiate through their entire lives, in their deeds and in their leisure, in their business and in the home, and more than all, in the books which they invite into their homes.

There is an inclination among the fellowmen of the older civilizations to look upon the Western Continent as grossly material. It is charged against us that the greed for gold has stunted the higher growth and blinded our eyes to nobler pursuits. A few days ago an eminent American journalist remarked that it is quite the custom among foreign peoples to refer to this great republic as a "dollar-worshipping nation." During the present month a Japanese statesman said: "America is essentially a commercial nation," meaning that money value here rises above other considerations. The journalist took a true American's exception to the Oriental estimate of our motives and morals and replied: "We respectfully submit that the American record is all to the contrary." Industry may be the dominant note in American character but it is not selfishness. The peoples of the earth have reaped the fruits of America's restless energy. It is a nation of builders and there will come a day when from the ranks of the workers there will rise poets and aesthetes, such as the world has never yet seen. The epoch of science and scholarship has dawned and we are on the threshold of the most beautiful revelations.

There is much truth in the philosopher's remark that every time every book we take up without a purpose is an opportunity lost of taking up a book with a purpose. It was Milton who charged that one might almost as well kill a man as kill a good book. The eminent Frederick Harrison truly said that the difficulties of literature are in their way as great as those of the world and that true books are not easier to find than true men; those who are on good terms with the first book they meet run as much risk as those who become friends of the first man that passes in the street; a man aimlessly wandering about in a crowded city is of all men the most lonely, so he who takes up only the books that he "comes across" is pretty certain to meet but few that are worth knowing. In this day of books, and books again, one of the first marks of a man's quality is his ability to choose the printed pages with which he wishes to associate. His culture is measured by his reading table; a man is known by the books he reads. This book comes to you as one who knocks at your door and seeks entrance into your home. It does not come to you with the pretense of being a perfect book, but it does come to you true to its purpose, noble in its impulses, and staunchly American.

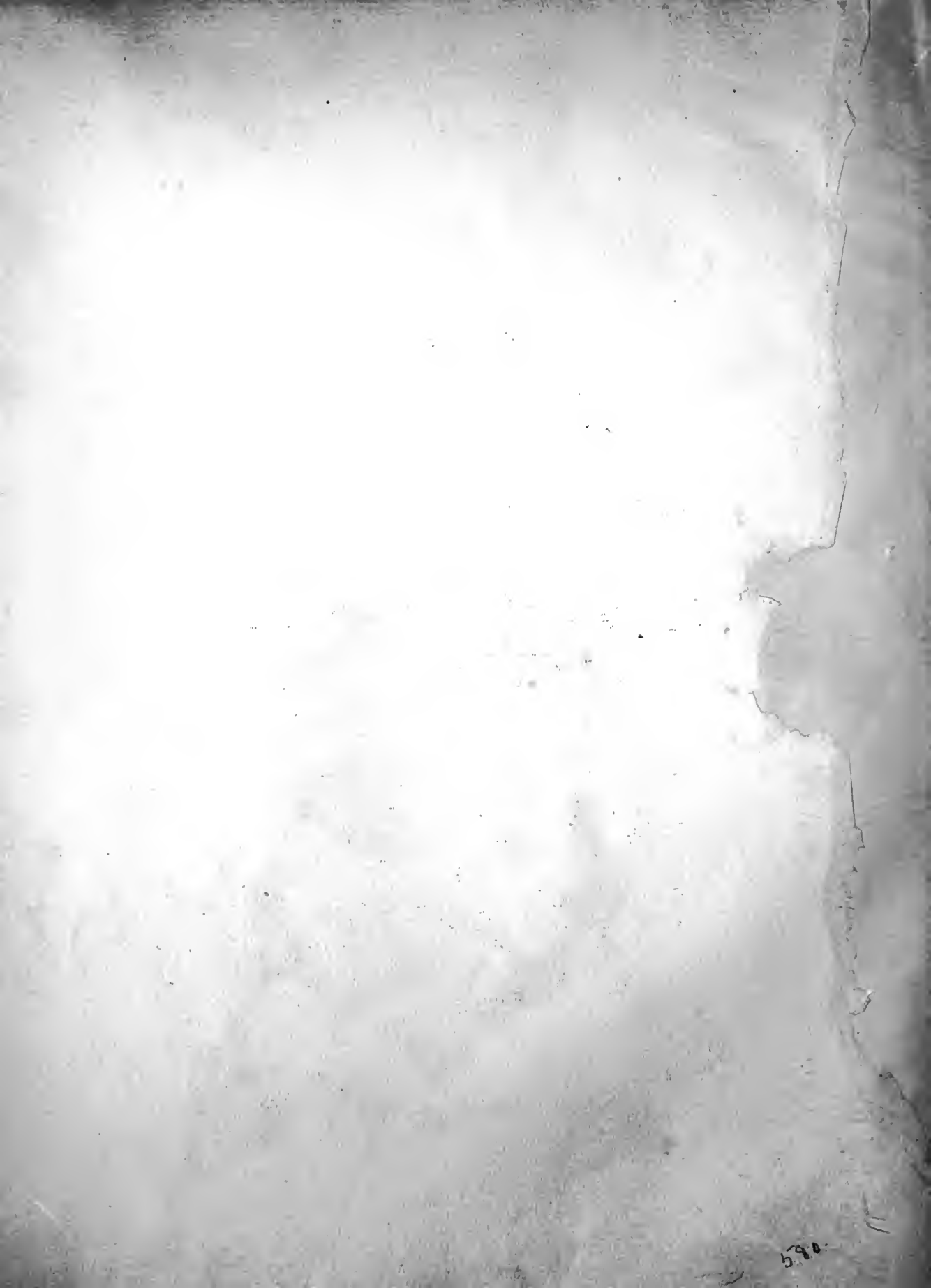

The Journal of L 40
American History



off. from W. S. Wallace July 1 - 4 - 1872





The Journal of
American History

Relating Life Stories of Men and
Events that have entered into the
Building of the Western Continent

REPRODUCTIONS FROM RARE
PRINTS AND WORKS OF ART
(AMERICANA)

Original Researches into Authoritative Sources—American, British and
European Archives—Private Journals, Diaries and Hitherto
Unpublished Documents—Fugitive Papers—
Reminiscences and Memoirs—
Folklore and Traditions

Associated Publishers of American Records

Produced by the Associated Publishers of American Records, Inc.
in the Ancient Municipality of New Haven, Commonwealth of Con-
necticut, in Quarterly Art Editions, four books to the volume
at Two Dollars annually, Fifty Cents a copy & Compiled
in Collaboration with the Connecticut Magazine
Protected by copyright and Printed from press
of the Dorman Lithographing Company
Publication entered at the Post
Office at New Haven as mail
matter of the second class
Nineteen Hundred
and Seven



Foreign

Three dollars annually & Seventy-five cents a copy

LONDON	B. F. Stevens & Brown 4 Trafalgar Square, W. C.	ST. PETERSBURG	Watkins and Company Marskala No. 36
PARIS	Brentano's 37, Avenue de l'Opera	CAIRO	F. Diemer Shepherd's Building
BERLIN	Asher and Company Unter den Linden 56	BOMBAY	Thacker and Company Limited Esplanade Road
DUBLIN	Combridge and Company 18 Grafton Street	TOKIO	Methodist Publishing House 2 Shichome, Giz Ginza
EDINBURGH	Andrew Elliott 17 Princes Street	MEXICO CITY	American Book & Printing Co. 1st San Francisco No. 13
MADRID	Libreria Internacional de Ad- rian Romo, Alcalá 5	ATHENS	Const. Eleotheroudakis Place de la Constitution
ROME	L. Piale 1 Piazza di Spagna	BUENOS AYRES	John Grant & Son Calle Cangallo 469

Syllabus of the Anniversary Number

FIRST VOLUME

FOURTH NUMBER

This book marks the close of the first year of the institution of a Periodical of Patriotism in America, inculcating the principles of American Citizenship, and narrating the Deeds of Honor and Achievement that are so true to American Character—This Anniversary Number is Dedicated to all Loyal Americans

HERALDIC ILLUMINATION—Coat-of-arms of Mary Ball, the Mother of the First President of the First Republic in the World—Emblazoned in gold, silver and colors by.....	Charles L. N. Camp
TWO HUNDREDETH ANNIVERSARY OF THE BIRTH OF THE MOTHER OF WASHINGTON—Ancient Engraving Dedicated to her Memory—The Original is in the Collection of John M. Crampton, and is known as "Washington's Last Interview with his Mother".....	
THE GREETING TO THE NATIONS—AMERICA'S BIRTHDAY—1607—1907—Words of Wisdom spoken by the Man who has been chosen by the People of our United States of America as their Leader—Excerpt from the Speech of the President at the opening of the Jamestown Exposition—Autograph copy kindly presented to "The Journal of American History" by.....	Theodore Roosevelt 581
AN ODE TO AMERICA—THE BUILDERS OF THE REPUBLIC—Poem by Judge Daniel J. Donahoe, Author of "A Message to Americans" in the preceding issue of "The Journal of American History".....	589
"THE PASSING OF THE DAY OF GREED"—Symbolic Photograph by John Gudebrod, of New York—Taken in the Early Evening at Castle Craig on the Peaks of Meriden.....	
SCULPTURE IN AMERICA—A Symposium of the Finest Pieces of Sculpture erected during the year of 1907.....	597
TO THE MEMORY OF THE HEART OF THE SOUTH—An Allegorical Figure bearing a Palm of Peace and Branch of Laurel covering the Sword, an Emblem of Glory For erection at Houston, Texas.....	By Louis Amatels, Sculptor 597
A TRIBUTE TO PEACE—Lunette on McKinley Memorial at Canton, Ohio By Charles H. Niehaus, Sculptor	599
PROSPERITY—Pediment for Kentucky State Capitol..	By Charles H. Niehaus, Sculptor 599
TO THE MEMORY OF A GREAT AMERICAN MATERIALIST—Colonel John A. Roebling, First Engineer of Brooklyn Bridge—Builder of the Great Span across Niagara Falls—For erection at Trenton, New Jersey.....	By William Couper, Sculptor 600
TO THE MEMORY OF A GERMAN-AMERICAN SOLDIER—General Franz Sigel—For Riverside Drive, New York City.....	By Karl Bitter, Sculptor 601
TO THE MEMORY OF THE TEXAS RANGERS—Erected at the State House in Austin, Texas.....	By Pompeo Coppini, Sculptor 602
TO THE MEMORY OF AMERICAN SACRIFICE—Erected at the old Andersonville Prison Grounds, in Georgia.....	By Bela Lyon Pratt, Sculptor 603
TO THE MEMORY OF THE AMERICAN SOLDIER—For the monument to Soldiers and Sailors at Webster, Massachusetts.....	By Finn H. Frolsch, Sculptor 604
TO THE MEMORY OF THE AMERICAN SAILOR—For the monument to Soldiers and Sailors at Webster, Massachusetts.....	By Finn H. Frolsch, Sculptor 605
TO THE MEMORY OF AN AMERICAN WARRIOR—General George Brinton McClellan Erected at Washington, District of Columbia..	By Frederick MacMonnies, Sculptor 606
TO THE MEMORY OF THE DISPATCH RIDER OF THE WAR FOR AMERICAN INDEPENDENCE—Erected at Orange, New Jersey By Frank Edwin Elwell, Sculptor	607
TO THE MEMORY OF THE FIRST FALLEN IN THE SPANISH-AMERICAN WAR—Ensign Worth Bagley, U. S. N., the only Naval Officer killed during that war—Erected in Capitol Square, Raleigh, North Carolina.....	By F. H. Packer, Sculptor 608
TO THE MEMORY OF A SOUTHERN WARRIOR—General John B. Gordon—Erected at State Capitol Grounds at Atlanta, Georgia.....	By Solon H. Borglum, Sculptor 609
TO THE MEMORY OF THE MARTYRED PRESIDENT—WILLIAM MCKINLEY—Erected in bronze in front of the National Memorial at Canton, Ohio By Charles H. Niehaus, Sculptor	610

INDEX CONTINUED (OVER)

Context with Engravings and Authors

FOURTH QUARTER

NINETEEN SEVEN

Chronicles of Those Who Have Done a Good Day's Work—
Rich in Information upon Which May Be Based Accurate
Economic and Sociologic Studies and of Eminent Value to
Private and Public Libraries—Beautified by Reproductions of
Ancient Subjects through the Modern Processes of American Art

CONTINUATION OF INDEX

- TO THE MEMORY OF A ROUGH RIDER WITH ROOSEVELT AT SANTIAGO—Cap-
tain "Buckey" O'Neill, killed in battle—Erected at Prescott, Arizona
By Solon H. Borglum, Sculptor 611
- TO THE MEMORY OF THE FIRST AMERICANS—Statue of the Indian Chief, Mahaska
Now being exhibited in the Salon at Paris—To be erected at Oskaloosa, Iowa
By S. E. Fry, Sculptor 612
- ANNIVERSARIES OF THE AMERICANS—One Hundredth Anniversary of the Birth of
Whittier the Poet—Two Hundredth Anniversary of the Birth of the Mother of
Washington—One Hundredth Anniversary of Washington Irving's "Salmagundi"
and William Cullen Bryant's "Embargo"—The Half Century Anniversary of the
"Atlantic Monthly"..... 613
- ONE HUNDREDTH ANNIVERSARY OF THE FOUNDING OF THE "SALMAGUNDI"
IN 1807—Reproduction from an Old Engraving of Washington Irving, after a
painting by Alonzo Chappel—Likeness from a daguerreotype in possession of the
family of the distinguished litterateur..... 615
- PHOTOGRAPHIC REPRODUCTION OF THE TITLE-PAGE OF FAMOUS OLD
"BISHOP'S BIBLE"—Published in 1584, and still in possession of the Seymour
Family in America—A survival of the earliest book-making..... 616
- ACROSS THE AMERICAN CONTINENT IN A CARAVAN—REMINISCENCES OF CAP-
TAIN JOSEPH ARAM—Recollections of a Journey from New York through the
Western Wilderness and over the Rocky Mountains to the Pacific in 1846—Adven-
tures with the Indians—First discovery of gold—First white child born in Cal-
ifornia—Early days on the Pacific Coast—Experiences of Captain Joseph Aram—
Transcript from the Original now in Possession of His Children in California
By Colonel James Tompkins Watson, of Clinton, New York 617
- FOUR HUNDRED YEARS OF THE PANAMA CANAL—First White Man to Cross the
Isthmus from the Atlantic to the Pacific—Futile attempts to find a Natural Water-
way Connecting the two Great Oceans—First Plans ever made to sever the Ameri-
cas with an artificial strait by Cortez in 1529—Investigations by Dr. Willis
Fletcher Johnson, of the "New York Tribune"—Resume from his researches
recently presented after more than twenty-five years' study of South American
affairs and Isthmian Canal Transit in his book "Four Hundred Years of Panama,"
published by Henry Holt and Company of New York..... 633
- THE STRUGGLE FOR THE CONTROL OF AMERICA—THE GREAT STORY OF THE
CARIBBEAN SEA—Ambition of the European Powers to add the Western Conti-
nent to their Empires—America's fate in the balance during the Great Battles on
the Spanish Main—Daring adventures of the Great Admirals of the Caribbean Sea—
Researches by Franklin Russell Hart, Member of many learned societies and
Fellow of the Royal Geographical Society of Great Britain—Copyright assigned
to the author..... 640
- AN EARLY AMERICAN FINANCIER—General Robert Patterson of Philadelphia—
Born in 1792—He was prominent in the development of the Sugar Industry of
Louisiana and the Cotton Mills of the South—An organizer of Railroad Communi-
cation with Baltimore, a Financier of the Pennsylvania Railroad, and Steamship
Transportation with the Southern ports and Europe—Portrait in possession of
his granddaughter, Mrs. Lindsay Patterson of North Carolina..... 652
- OBSERVATIONS OF AN EARLY AMERICAN CAPITALIST—"HE WAS BORN A
KING"—An Early Journey in the Mississippi Valley—Accurate Transcript from

Transcripts From Ancient Documents

OCTOBER

NOVEMBER

DECEMBER

Collecting the Various Phases of History, Art, Literature, Science, Industry, and Such as Pertains to the Moral, Intellectual and Political Uplift of the American Nation—Inspiring Nobility of Home and State—Testimonial of the Marked Individuality and Strong Character of the Builders of the American Republic

CONTINUATION OF INDEX

- Journal of General Robert Patterson, born in 1792—An intimate friend of all the Presidents from Jefferson to Garfield, and one of the greatest merchant-magnates of his generation—Eminent Americans and Europeans gathered at his mansion in Philadelphia—Original diary in possession of his granddaughter, Mrs. Lindsay Patterson, of Winston-Salem, North Carolina..... 653
- HIEROGLYPHIC NARRATIVE OF THE CAREER OF GENERAL ROBERT PATTERSON**—Reproduction from original made by his son, Colonel William Houston Patterson, in imitation of the character writing of the American aborigines..... 660
- THE FATHER OF THE AMERICAN NAVY—JOHN BARRY**—First commander of the first vessel to fight under the American Flag—The "Lexington," named after the first battle in the American Revolution, captured the first British ship in the struggle for Independence—The story of Commodore John Barry, Born in 1745
By Richard M. Relly, Member of the Pennsylvania Bar 669
- THE RISE OF A NEW SURGICAL SCIENCE**—Evolution of a Personal Adornment into the Self-Protection of the Human Race—Uplift of a Mental Trade to a Great American Profession which now bears the "Hall Mark" of Culture and has become a part of the American Educational System—The birth of Dental surgery
By Dr. James McManus,
Author of a Treatise on "History of Anaesthesia,"
and a Dean of American Dentistry 675
- CENTENNIAL OF THE SAVINGS BANK**—One hundred years ago the modern system was first outlined in the House of Commons—Duke of Wellington remarked that if men had money to spare it was time to reduce their pay—First savings banks in America and their marvelous effect on Industry and Thrift
By Honorable Norman White 685
- THE DEVELOPMENT OF AMERICAN FINANCE**—Its moral effect on American citizenship—Liberty and the mighty economic problem—The democracy of negotiable securities—The Ten Commandments in business—By the Editor of the "Wall Street Journal".....Serenio D. Pratt 687
- FIRST PAPER MONEY IN AMERICA IN 1690**—Actual facsimile of the First Paper Money in America, which eventually led to the American Banking System—First authorized to meet the necessities of the Colonial Treasuries to wage war, and soon became generally established in relieving commercial and financial embarrassment.....By Henry Russell Drowne,
Of the American Numismatic and Archaeological Society 693
- LETTERS OF EARLY AMERICAN WARRIORS**—Correspondence of the first citizens of the Nation, revealing their Personalities and Private Lives—A Romance of the North and South more than a century ago—Intimate friendships of distinguished Americans—Social relations of the families of Officers in the early wars—Cut of Powder Horn presented to General Jackson in 1782 for his Bravery in the American Revolution—From original letters now in possession of Charles Eben Jackson, a descendant of General Michael Jackson.....By Mabel Cassine Holman 697
- ANCIENT MINIATURE OF EBENEZER JACKSON, SENIOR, A GENTLEMAN OF THE FIRST DAYS OF THE AMERICAN REPUBLIC**—Original in the possession of Mr. Charles Eben Jackson..... 698
- ANCIENT MINIATURE OF CHARLOTTE FENWICK—A BEAUTY OF THE REVOLUTIONARY PERIOD IN AMERICA**—Original in the possession of Mr. Charles Eben Jackson..... 708

INDEX CONTINUED (OVER)

571d.

Conclusion of the First Volume

FRANCIS T. MILLER
PRESIDENT

EDWARD O. DORMAN
SECRETARY

MARLETTE CROUSE
TREASURER

In presenting this last number of the First Year of "The Journal of American History" the publishers take pleasure in making public recognition of the eminent services of the writers who have appeared in the initial volume—It is only through them that the periodical has become notable in American Letters

CONCLUSION OF INDEX

AMERICA'S TRIBUTE TO FRANCE—A Centennial Ode to Comte de Rochambeau By John Gaylord Davenport, D.D.	712
AN ANECDOTE OF COUNT ROCHAMBEAU IN AMERICA—"Come, Haste to the Wedding"—An Old Song—By the granddaughter of the heroine of this incident Susan E. M. Jocelyn	713
EXPERIENCES OF AN AMERICAN EDUCATOR IN FIRST YEARS OF THE REPUBLIC—Manuscript of James Morris, born in 1752, in which he tells of being charged with violation of Christian peace and placed on trial for conducting a private school and instructing young women in higher education—Personal narrative of an early lecturer on public morals—Original manuscript in possession of Mrs. Washington Choate, great-granddaughter of James Morris—Sketches by Florence E. D. Muzzy	717
FIRST PUBLIC SCHOOLS IN NEW YORK—Rare old print made in 1840—The Lancaster Monitorial School, an educational idea imported from England	718
OLD PRINT OF AN INFANT SCHOOL IN NEW YORK IN 1825	718
AN AMERICAN'S EXPERIENCE IN THE BRITISH ARMY—Manuscript of Colonel Stephen Jarvis, born in 1756, revealing the life of the Loyalists who refused to renounce their allegiance to the king and fought to save the Western Continent to the British Empire—Relating the remarkable experiences as a recruit in the lines of the British army—Accurate transcript from the original manuscript which was lost for many years and has been recently recovered now in possession of Honorable Charles Maples Jarvis, Descendant of Colonel Jarvis and Member of many American learned and patriotic societies	727
NATURE'S GRANDEUR IN AMERICA—The Monarch Niagara—Four Reproductions from Nature Illustrations	741
FIRST FORTUNES IN AMERICAN REPUBLIC—Letters of a Banker who helped to Establish the Credit of American Business Houses in the European Market—Great Commercial Ventures in the Tropics—Trading Voyages to China—Opening Traffic on the St. Lawrence River and Lake Ontario—Founding a Fortune in America one hundred years ago—Correspondence of David Parish and Joseph Rosseel By Frank R. Rosseel, Buffalo, New York Grandson of Joseph Rosseel, the Financial Agent of the Parish Estate	745
CONTEMPORARY THOUGHT IN AMERICA—"The Press of the Republic is the Moulder of Public Opinion, the Leader and Educator"	762
Americanism calls for the good in man, not the bad—Editorial writer in the "Atlanta Constitution"	762
An American view of the future of South Africa—Editorial writer in the "New Orleans Picayune"	762
America's greatest political idol and his failure—Editorial writer in the "Indianapolis Journal"	763
America should lead world to universal peace—Editorial writer in the Lincoln "Commoner"	763
World's upbuilding is in need of more money—Editorial writer in the "Seattle Post-Intelligencer"	764
Tremendous power held by one American financier—Editorial writer in the "St. Louis Globe-Democrat"	764
AMERICANA DUBIA—MOOTED QUESTIONS IN HISTORY—Open Discussions	765
THE LAST LEAF—Editorial Comment	766





On this Two Hundredth Anniversary of the Birth of the Mother of Washington, this Ancient Engraving is Dedicated to Her Memory—The Original is in the Collection of John M. Crampton, and is known as "Washington's Last Interview with His Mother."

The Journal of American History



VOLUME I
NINETEEN SEVEN

EDITED BY FRANCIS TREVELYAN MILLER

NUMBER IV
FOURTH QUARTER

The Greeting to the Nations 1607—America's Birthday—1907

BY

Theodore Roosevelt

PRESIDENT OF THE UNITED STATES

AT the outset I wish to say a word of special greeting to the representatives of the foreign governments. They have come to assist us in celebrating what was in very truth the birthday of this nation, for it was here that the colonists first settled, whose incoming, whose growth from their own loins and by the addition of newcomers from abroad, was to make the people which one hundred and sixty-nine years later assumed the solemn responsibilities and weighty duties of complete independence.

In welcoming all of you I must say a special word, first to the representative of the people of Great Britain and Ireland. The fact that so many of our people, of whom as it happens I myself am one, have but a very small portion of English blood in our veins, in no way alters the other fact that this nation was founded by Englishmen, by the Cavalier and the Puritan. Their tongue, law, literature, the fund of their common thought, made an inheritance which all of us share, and marked deep the lines along which we have developed. It was the men of English stock who did most in casting the mold into which our national character was run.

LET me furthermore greet all of you, the representatives of the people of continental Europe. From almost every nation of Europe we have drawn some part of our blood, some part of our traits. This mixture of blood has gone on from the beginning, and with it has gone on a kind of development unexampled among peoples of the stocks from which we spring; and hence to-day we differ sharply from, and yet in some ways are fundamentally akin to, all of the nations of Europe.

Again, let me bid you welcome, representatives of our sister Republics of this continent. In the larger aspect, your interests and ours are identical. Your problems and ours are in large part the same; and as we strive to settle them, I pledge you herewith on the part of this nation the heartiest friendship and goodwill.

Finally, let me say a special word of greeting to those representatives of the Asiatic nations who make up that newest East which is yet the most ancient East, the East of time immemorial. In particular, let me express a word of hearty welcome to the representative of the mighty island empire of Japan; that empire, which, in learning from the West, has shown that it had so much, so very much, to teach the West in return.

To all of you here gathered I express my thanks for your coming, and I extend to you my earnest wishes for the welfare of your several nations. The world has moved so far that it is no longer necessary to believe that one nation can rise only by thrusting another down. All far-sighted statesmen, all true patriots, now earnestly wish that the leading nations of mankind, as in their several ways they struggle constantly toward a higher civilization, a higher humanity, may advance hand in hand, united only in a generous rivalry to see which can best do its allotted work in the world. I believe that there is a rising tide in human thought which tends for righteous international peace; a tide which it behooves us to guide through rational channels to sane conclusions; and all of us here present can well afford to take to heart St. Paul's counsel: "If it be possible, as much lieth in you, live peaceably with all men."

We have met . . . to celebrate the . . . Exposition which itself commemorates the first permanent settlement of men of our stock in Virginia, the first beginning of what has since become this mighty Republic. Three hundred years ago a handful of English adventurers, who had crossed the ocean in what we should now call cockle-boats, as clumsy as they were frail, landed in the great wooded wilderness, the Indian-haunted waste, which then stretched down to the water's edge along the entire Atlantic coast. They were not the first men of European race to settle in what is now the United States, for there were already Spanish settlements in Florida and on the headwaters of the Rio Grande; and the French, who at almost the same time were struggling up the St. Lawrence, were likewise destined to form permanent settlements on the Great Lakes and in the valley of the mighty Mississippi before the people of English stock went westward of the Alleghenies.

MA

OREOVER, both the Dutch and the Swedes were shortly to found colonies between the two sets of English colonies, those that grew up around the Potomac and those that grew up on what is now the New England coast. Nevertheless, this landing at Jamestown possesses for us of the United States an altogether peculiar significance, and this without regard to our several origins. The men who landed at Jamestown and those who, thirteen years later, landed at Plymouth, all of English stock, and their fellow-settlers who during the next few decades streamed in after them, were those who took the lead in shaping the life history of this people in the colonial and revolutionary days. It was they who bent into definite shape our nation while it was still young enough most easily, most readily, to take on the characteristics which were to become part of its permanent life habit.

Yet let us remember that while this early English colonial stock has left deeper than all others upon our national life the mark of its strong twin individualities, the mark of the Cavalier and of the Puritan—nevertheless, this stock, not only from its environment but also from the presence with it of other stocks, almost from the beginning began to be differentiated strongly from any European people. As I have already said, about the time the first English settlers landed here, the Frenchman and the Spaniard, the Swede and the Dutchman, also came hither as permanent dwellers, who left their seed behind them to help shape and partially to inherit our national life. The German, the Irishman and the Scotchman came later, but still in colonial times. Before the outbreak of the Revolution the American people, not only because of their surroundings, physical and spiritual, but because of the mixture of blood that had already begun to take place, represented a new and distinct ethnic type. This type has never been fixed in blood. All through the colonial days new waves of immigration from time to time swept hither across the ocean, now from one country, now from another. The same thing has gone on ever since our birth as a nation; and for the last sixty years the tide of immigration has been at the full. The newcomers are soon absorbed into our eager national life, and are radically and profoundly changed thereby, the rapidity of their assimilation being marvelous. But each group of newcomers, as it adds its blood to the life, also changes it somewhat, and this change and growth and development have gone on steadily, generation by generation, throughout three centuries.

The pioneers of our people who first landed on these shores on that eventful day three centuries ago, had before them a task which during the early years was of heartbreaking danger and difficulty. The conquest of a new continent is iron work. People who dwell in old civilizations and find that therein so much of humanity's lot is hard, are apt to complain against the conditions as being solely due to man and to speak as if life could be made easy and simple if there were but a virgin continent in which to work.

IT is true that the pioneer life was simpler, but it was certainly not easier. As a matter of fact, the first work of the pioneers in taking possession of a lonely wilderness is so rough, so hard, so dangerous that all but the strongest spirits fail. The early iron days of such a conquest search out alike the weak in body and the weak in soul. In the warfare against the rugged sternness of primeval Nature, only those can conquer who are themselves unconquerable. It is not until the first bitter years have passed that the life becomes easy enough to invite a mass of newcomers, and so great are the risk, hardship, and toil of the early years that there always exists a threat of lapsing back from civilization.

The history of the pioneers of Jamestown, of the founders of Virginia, illustrates the truth of all this. Famine and pestilence and war menaced the little band of daring men who had planted themselves alone on the edge of a frowning continent. Moreover, as men ever find, whether in the tiniest frontier community or in the vastest and most highly organized and complex civilized society, their worst foes were in their own bosoms. Dissension, distrust, the inability of some to work and the unwillingness of others, jealousy, arrogance and envy, folly and laziness—in short, all the shortcomings with which we have to grapple now, were faced by those pioneers, and at moments threatened their whole enterprise with absolute ruin. It was some time before the ground on which they had landed supported them, in spite of its potential fertility, and they looked across the sea for supplies. At one moment so hopeless did they become that the whole colony embarked, and was only saved from abandoning the country by the opportune arrival of help from abroad.

At last they took root in the land, and were already prospering when the Pilgrims landed at Plymouth. In a few years a great inflow of settlers began. Four of the present states of New England were founded. Virginia waxed apace. The Carolinas grew up to the south of it, and Maryland to the north of it. The Dutch colonies between, which had already absorbed the Swedish, were in their turn absorbed by the English. Pennsylvania was founded and, later still, Georgia. There were many wars with the Indians and with the dauntless captains whose banners bore the lilies of France. At last the British flag flew without a rival in all eastern North America. Then came the successful struggle for national independence.

For half a century after we became a separate nation there was comparatively little immigration to this country. Then the tide once again set hither, and has flowed in ever-increasing size until in each of the last three years a greater number of people came to these shores than had landed on them during the entire colonial period. Generation by generation these people have been absorbed into the national life. Generally their sons, almost always their grandsons, are indistinguishable from one another and from their fellow-Americans descended from the colonial stock.

FOR all alike the problems of our existence are fundamentally the same, and for all alike these problems change from generation to generation. In the colonial period, and for at least a century after its close, the conquest of the continent, the expansion of our people westward, to the Alleghenies, then to the Mississippi, then to the Pacific, was always one of the most important tasks, and sometimes the most important, in our national life. Behind the first settlers the conditions grew easier, and in the older-settled regions of all the colonies life speedily assumed much of comfort and something of luxury; and though generally it was on a much more democratic basis than life in the Old World, it was by no means democratic when judged by our modern standards; and here and there, as in the tide-water regions of Virginia a genuine aristocracy grew and flourished. But the men who first broke ground in the virgin wilderness, whether on the Atlantic coast, or in the interior, fought hard for mere life. In the early stages the frontiersman had to battle with the savage, and when the savage was vanquished there remained the harder strain of war with the hostile forces of soil and climate, with flood, fever, and famine. There was sickness, and bitter weather; there were no roads; there was a complete lack of all but the very roughest and most absolute necessities. Under such circumstances the men and women who made ready the continent for civilization were able themselves to spend but little time in doing aught but the rough work which was to make smooth the ways of their successors. In consequence, observers whose insight was spoiled by lack of sympathy always found both the settlers and their lives unattractive and repellant. In Martin Chuzzlewit the description of America, culminating in the description of the frontier town of Eden, was true and lifelike from the standpoint of one content to look merely at the outer shell; and yet it was a community like Eden that gave birth to Abraham Lincoln; it was men such as were therein described from whose loins Andrew Jackson sprang. Each generation has had its allotted task, now heavier, now lighter. In the Revolutionary War the business was to achieve independence. Immediately afterwards there was an even more momentous task; that to achieve the national unity and the capacity for orderly development, without which our liberty, our independence, would have been a curse and not a blessing. In each of these two contests, while there were many great leaders from many different states, it is but fair to say that the foremost place was taken by the soldiers and the statesmen of Virginia; and to Virginia was reserved the honor of producing the hero of both movements, the hero of the war, and of the peace that made good the results of the war—George Washington; while the two great political tendencies of the time can be symbolized by the names of two other great Virginians—Jefferson and Marshall—from one of whom we inherit the abiding trust in the people which is the foundation stone of democracy, and from the other the power to develop on behalf of the people a coherent, powerful government, a representative nationality.

TWO generations passed before the second great crisis of our history had to be faced. Then came the Civil War, terrible and bitter in itself and in its aftermath, but a struggle from which the Nation finally emerged united in fact as well as in name, united forever. Oh, my hearers, my fellow countrymen, great indeed has been our good fortune; for as time clears

away the mists that once shrouded brother from brother and made each look "as through a glass darkly" at the other, we can all feel the same pride in the valor, the devotion and the fealty toward the right as it was given to each to see the right, shown alike by the men who wore the blue and by the men who wore the gray. Rich and prosperous though we are as a people, the proudest heritage that each of us has, no matter where he may dwell, North or South, East or West, is the immaterial heritage of feeling, the right to claim as his own all the valor and all the steadfast devotion to duty shown by the men of both the great armies, of the soldiers whose leader was Grant and the soldiers whose leader was Lee. The men and the women of the Civil War did their duty bravely and well in the days that were dark and terrible and splendid. We, their descendants, who pay proud homage to their memories, and glory in the feats of might of one side no less than of the other, need to keep steadily in mind that the homage which counts is the homage of heart and of hand, and not of the lips, the homage of deeds and not of words only. We, too, in our turn, must prove our truth by our endeavor. We must show ourselves worthy sons of the men of the mighty days by the way in which we meet the problems of our own time. We carry our heads high because our fathers did well in the years that tried men's souls; and we must in our turn so bear ourselves that the children who come after us may feel that we too have done our duty.

We cannot afford to forget the maxim upon which Washington insisted, that the surest way to avert war is to be prepared to meet it. Nevertheless, the duties that most concern us of this generation are not military, but social and industrial. Each community must always dread the evils which spring up as attendant upon the very qualities which give it success. We of this mighty western Republic have to grapple with the dangers that spring from popular self-government tried on a scale incomparably vaster than ever before in the history of mankind, and from an abounding material prosperity greater also than anything which the world has hitherto seen.

As regards the first set of dangers, it behooves us to remember that men can never escape being governed. Either they must govern themselves or they must submit to being governed by others. If from lawlessness or fickleness, from folly or self-indulgence, they refuse to govern themselves, then most assuredly in the end they will have to be governed from the outside. They can prevent the need of government from without only by showing that they possess the power of government from within.

A SOVEREIGN cannot make excuses for his failures; a sovereign must accept the responsibility for the exercise of the power that inheres in him; and where, as is true in our Republic, the people are sovereign, then the people must show a sober understanding and a sane and steadfast purpose if they are to preserve that orderly liberty upon which as a foundation every republic must rest.

In industrial matters our enormous prosperity has brought with it certain grave evils. It is our duty to try to cut out these evils without at the same time destroying our well-being itself. This is an era of combination alike in the world of capital and in the world of labor. Each kind of combination can do good, and yet each, however powerful, must be opposed when it does ill. At the moment the greatest problem before us is how to exercise such control over the business use of vast wealth, individual, but especially corporate, as will insure its not being used against the interest of the public, while yet permitting such ample legitimate profits as will encourage individual initiative. It is our business to put a stop to abuses and to prevent their recurrence, without showing a spirit of mere vindictiveness for what has been done in the past. In John Morley's brilliant sketch of Burke he lays especial stress upon the fact that Burke more than almost any other thinker or politician of his time realized the profound lesson that in politics we are concerned not with barren rights but with duties; not with abstract truth, but with practical morality. He especially eulogizes the way in which in his efforts for economic reform, Burke combined unshakable resolution in pressing the reform with a profound temperateness of spirit which made him, while bent on the extirpation of the evil system, refuse to cherish an unreasoning and vindictive ill-will toward the men who had benefited by it. Said Burke, "If I cannot reform with equity I will not reform at all. * * * (There is) a state to preserve as well as a state to reform."

This is the exact spirit in which this country should move to the reform of abuses of corporate wealth. The wrong-doer, the man who swindles and cheats, whether on a big scale or a little one, shall receive at our hands mercy as scant as if he committed crimes of violence or brutality. We are unalterably determined to prevent wrongdoing in the future; we have no intention of trying to wreak such an indiscriminate vengeance for wrongs done in the past as would confound the innocent with the guilty. Our purpose is to build up rather than to tear down. We show ourselves the truest friends of property when we make it evident that we will not tolerate the abuses of property. We are steadily bent on preserving the institution of private property; we combat every tendency toward reducing the people to economic servitude; and we care not whether the tendency is due to a sinister agitation directed against all property, or whether it is due to the actions of those members of the predatory classes whose anti-social power is immeasurably increased because of the very fact that they possess wealth.

ABOVE all, we insist that while facing changed conditions and new problems, we must face them in the spirit which our forefathers showed when they founded and preserved this Republic. The cornerstone of the Republic lies in our treating each man on his worth as a man, paying no heed to his creed, his birthplace, or his occupation, asking not whether he is rich or poor, whether he labors with head or hand; asking only whether he acts decently and honorably in the various relations of his life, whether he behaves well to his family, to his neighbors, to the state. We base our regard for each man on the essentials and not the accidents. We judge him not by his profession, but by his deeds; by his conduct, not by what he has acquired of this world's goods. Other republics have fallen, because the citizens gradually grew to consider the interests of a class before the interests of the whole; for when such was the case it mattered little whether it was the poor who plundered the rich or the rich who exploited the poor; in either event the end of the Republic was at hand. We are resolute in our purpose not to fall into such a pit. This great Republic of ours shall never become the government of a plutocracy, and it shall never become the government of a mob. God willing, it shall remain what our fathers who founded it meant it to be—a government in which each man stands on his worth as a man, where each is given the largest personal liberty consistent with securing the well-being of the whole, and where, so far as in us lies, we strive continually to secure for each man such equality of opportunity that in the strife of life he may have a fair chance to show the stuff that is in him. We are proud of our schools and of the trained intelligence they give our children the opportunity to acquire. But what we care for most is the character of the average man; for we believe that if the average of character in the individual citizen is sufficiently high, if he possesses those qualities which make him worthy of respect in his family life and in his work outside, as well as the qualities which fit him for success in the hard struggle of actual existence—that if such is the character of our individual citizenship, there is literally no height of triumph unattainable in this vast experiment of government by, of, and for a free people.

These Words of Wisdom from the Man who has been chosen by the People of the First Republic in the World as their Leader, mark an Epoch in the annals of Mankind—Spoken at the Three Hundredth Anniversary of the First Permanent English Settlement in America, the observance of which is now drawing to a close at Jamestown, Virginia, they are emblazoned on these pages as a significant contribution to American historical literature—This publication, with the permission of the President, is from an autograph copy kindly presented by Mr. Roosevelt to The Journal of American History

The Builders of the Republic

An Ode to America

BY

JUDGE DANIEL J. DONAHOE

AUTHOR OF "A MESSAGE TO AMERICANS" IN THE PRECEDING ISSUE OF
THE JOURNAL OF AMERICAN HISTORY

THE bloom of summer shines upon the world
In changing glory; over field and grove
Floats a soft breathing, and a voice of joy
Rises from hill and valley. Every stream
Mirrors the beauty both of earth and sky.
And, murmurous of music, runneth on
Above the shallows; while against the sun,
Silent and broad, the curving river gleams
Like a great saber, from some giant hand
Cast, 'mid the cloven hills, and flashing lies,
A symbol of eternal power and peace.

But not alone the granite hills that stand
Against the ocean, and the river's flood
Moving in majesty, make manifest
The power that guards the nation. On each hand
Our eyes are blessed with marvels that bespeak
Man's greatness, and the sovereignty he bears
O'er nature's forces. Like a willing slave,
The fettered lightning bows unto his needs,
And trained to harmless toil, obeys his will.
The streams that leap in laughter down the hills
Are caught and harnessed to the restless wheels
That sing in ceaseless industry; while clouds,
Rising above the myriad-windowed mills
In folds of light, show where the strength of steam
Makes great the cities with the night of toil.

Thus is the power of labor multiplied,
And thus unto the toiler's hand brings home,
As guerdon of his skill, unbounded wealth,
And opportunity wide as the stars;
While peace, with shining footsteps, through the land
Walks, where a thousand farmsteads, rich with meads,
Pastures and fields of tilth, drink in the rays
Of the new morn that rises with the light
Of prophecy, and promises to all
A golden harvest.

The
Builders
of the
Republic

ROUND each village spire,
That, pointing starward, speaks eternal truths,
Cluster a group of cottages with lawns
Wide to the street. These are the glad abodes
Of labor, culture, love and liberty.
Here nought of evil on the surface shows,
Nor cloud of sorrow darkens; but where'er
The gazer turns, such happiness as blessed
The primal Eden seems to fill the land.

Long on these grateful scenes we turn our eyes,
Drinking into our souls dreams of delight;
And backward glancing, lift our heads aloft
With a broad meaning; for we see how broad
Have been the strides of progress since the bell
From Independence Hall startled the world
And thrilled the people with new life and hope.
Nor shall the present and the past suffice;
But down the shining slope of future years
We peer with souls high-swelling, and descry
The vision of the wonders yet to be.

But let nor pride nor hope our souls deceive
And soothe us with a false security;
Nay, let us pause amid our sunny dreams
And pierce with searching eye the golden veil
That covers o'er with splendor all the land,
Yet hides, perchance, some foul or evil blight
That worketh waste or woe. Sharp scrutiny
Must needs be made of license and of law
By men who love their country and would keep
Her strength and honor safe. This wisdom wills,
Lest all too confident, in strength assured,
Our souls become elate and filled with pride
Of past achievements, both in peace and war,
Of foolish dreams of greatness, that may well
Betray us, while corruption threatens death.

Neither by day nor night may rest be ours;
But care and watching shall our duty be,
For we are toilers still. Our work remains
All unaccomplished, while a flaw abides,
Or chance of danger. Perfect government
In town and state and nation, this must be
Our dear ambition.

And though hero souls
Are ours, and ours the age of heroes, God
Demands our best of labor. Serious thought,
Not overweening boasts, will satisfy
The everlasting Justice. Bowed in soul,
True servants, we must look for Heaven's behest,
And with the light that shineth from the Throne,
Bend to achieve the glory of His will.

The
Builders
of the
Republic

NOR may we our stern duty minimize;
As men of might, within our hand is placed
A sacred charge requiring holiest care,
A trust that brooks no faltering in faith.

We are the nation's builders. If we strive
With heart and hand and brain to raise the walls
And glorify the temple, we but yield
To conscience that, with unrelenting voice,
Guides us to justice; and the house we build
Must be the house of justice. Light and law
Shall shine within its portals. Let it be
A palace worthy of the Lord, whose love
Smiles on no worthless effort. And unless
He build with us our labor is but vain;
And our achievements, howsoever brave,
Are like the splendors of a sunset cloud;
And howsoever high the house we build,
And bright with grandeur, 'tis a Babel Tower,
A monument of folly and of shame.

But where shall we find justice? Who shall guide
Our footsteps lest we stumble in the dark?
Masked in the garb of wisdom, danger walks,
Lighting false beacons, that may lead to death,
While boasting of supremacy and power.

Let us beware. This increase manifold
Of labor's gain from nature's mastered powers,—
Where shall it go? Shall men, who worship wealth,
Make for themselves a privilege and hold
The ninety parts and nine, while labor's host,
The mighty army that has made the wealth,
Takes but the single unit as its wage?
Shall the rich revel in wild luxury,
While, as in France of old, the poor attempt
To quell their hunger with the grass, like beasts?

If men are thus oppressed what power can save
The nation from disgrace? No wrong can live,
But ruin, soon or late, avenging comes
To blaze a road for justice. Then, beware!
Not for the money-changer is the house
Of honor builded, but for men whose souls
Look heavenward and seek the things of God.
Yet in our temple we behold, even now,
The holy place proclaimed as Mammon's throne;
The worshipers of wealth its walls profane,
And on its altars raise a golden calf.
Scorning the broader Brotherhood of Christ,
And swollen with privilege, in robes of gold,
The priest of Mammon lifts his impious face,
And sends his proud voice echoing through the skies:

Hymn of Privilege

*God of the golden horn,
Bright in thy golden rays;
God from whose hand is born
All that our lives adorn,—
God of the golden horn,
Thee we adore and praise.
Thou that art proud and great,
Honor the great and proud;
Lift up our souls elate;
Keep us to rule the state!
Thou that art proud and great,
Hear us; our heads are bowed.*

*Ruler of wealth and ease,
Keep us in ease and wealth;
Poverty, toil, disease;—
Save us from ills like these;
Ruler of wealth and ease.
Bless us with peace and health.*

*God of the golden horn,
Thee we adore and praise;
Safe on thy strength upborne,
Lead us from need and scorn;
God of the golden horn,
Guide us through golden days.*

The
Builders
of the
Republic

NOR comes less danger from the wretch, whose
fare
Is with the beast. The innocent toiler, stung
By hunger's fangs, may grow more ravenous
Than tiger in the jungle. In his soul
The wrong may rankle, and break forth in fire
Whose flame shall scorch the heavens. When the cry
Rose from the rabid masses in the streets
Of Paris, reason slept; and nought could save
The crown of privilege from the guillotine.
How shall injustice thrive more safely here,
And walk with steps impune upon the neck
Of prostrate industry? Beware! the hour
Of reckoning comes and danger's signal flies!
Have ye not heard the shout of wild despair
That rises from the slums? Your hand can save
Only by lifting up with tenderness
And weighing in the balances of Right
The portion due to labor.

All too long

Justice has been delayed. The dens of crime,
Where day is turned to night, and sin becomes
The stay of hunger, threaten to destroy
The glory of your building. If unmoved
By reason and pure justice, let your fear
Arouse your souls to honor. Moloch's sons,
A hideous host, are in your temple now,
And loud in adoration. Hear their hymn!

Hymn of the Destroyers

*Hear us, O God of Shame,
Moloch! we call thy name,
And seek thy evil service, power divine!
To thee we bend the knee;
We look for help to thee;
Crushed in the mire of sin, our souls are thine.*

*Thou baneful deity,
We sacrifice to thee
Our children; soul and body they are thine!
Through long and weary years,
Through misery and tears,
They bow beneath thy influence unbenign.*

*What boots it, loathsome god,
To feel the cruel rod,
Unless we gain the pleasures that we seek?
'Mid drudgery and grime
We find our good in crime,
With flinty hearts and bloody hands that reek.*

The
Builders
of the
Republic

NOT out of gilded palaces shall come
Abiding righteousness ; nor shall we seek
An uplift from the rotting tenements.
These are alike sure tokens of disease
That warn the nation of impending death.

Not out of these our dreams of grandeur come ;
But from the farmsteads and the toilers' homes,
Scattered like new-blown roses o'er the hills,
And through the sounding valleys, where the streams
Roar through their channels, loud with cheerful toil.

Out of such homes may wisdom hear the voice
Of freedom chanting hymns of sacred peace ;
Out of such homes alone the call shall lead
To honor's court, where even-handed right
Demands that crime, in hovel or in hall,
Shall suffer equal shame. The hour requires
Strong men, brave men of wisdom and of will
To break the sleep of justice. Let her rise
And render unto every man his due,
Both interest and wages, while the land,
With all the unbought gifts of bounteous heaven,
Shall bear the nation's burden.

This must come ;

For only by its coming may we hope
To build aright our temple's holy walls
And rear its hallowed altars ; only thus
The law of love shall fill its ample space
With such effulgence as can never pale.

The
Builders
of the
Republic

THEN labor shall uplift a thousand homes,
True shrines of godliness and liberty,
Where now the castle of the millionaire
Usurps with gorgeous insolence the land,
And holds wide acres in dead idleness.

Out of the slums pale children shall be brought
To rise and run in new-found life and joy,
To play like the young lambs among the fields,
And sing like birds under the blue heaven.
The haunts of pestilence and poverty,
Where beggared merit oft in hunger weeps,
With dens of degradation, sin and death,
Like the rich robber's hold shall be brought low
And the pure winds of heaven shall breathe thereon.
The city streets and the wide country-side
Shall sweeten like flower-gardens in God's air ;
And men shall lift their faces to the stars,
Unscathed by wrong, guiltless of infamy.

Then shall our hearts be lifted up to heaven
When we behold the bloom upon the hills ;
And to the voice of gladness from the vales
Our souls shall swell in answer. Evermore
The river in its silent course shall gleam,
Like a great saber, flashing to the skies,
A symbol of eternal power and peace.
Then from the earth shall rise, in thunder-tones,
The blessings of the ransomed multitudes ;
Forever swell along the echoing skies,
The song of neither arrogance nor shame,
But a true hymn of glory unto God,
From souls strong with the brotherhood of love.



"THE PASSING OF THE DAY OF GREED"

Symbolic Photograph by John Gudebrod of
New York

Taken in the Early Evening at Castle Craig on the
Peaks of Meriden

546^a





TO THE MEMORY OF THE HEART OF THE SOUTH—An Allegorical Figure bearing a Palm of Peace and Branch of Laurel covering the Sword, an Emblem of Glory.—By Louis Amateis, Sculptor—For Erection at Houston, Texas

Hymn of the People

*O God of life and love and light,
We send our voice in song to thee;
Thy hand hath led us through the night,
Thy power hath raised and made us free.*

*Be still our guide, our strength, our stay;
Blest by Thy name from shore to shore,
To Thee we turn both night and day,
From humbled hearts thy grace implore.*

*Let justice, truth and love abound;
Keep us as brothers, hand in hand;
Be neither fear nor falsehood found,
Nor greed nor hunger mar the land.*

*A ransomed nation, strong and free,
Let grateful love our aims upraise;
God of our fathers, unto Thee
We send our songs in holy praise.*

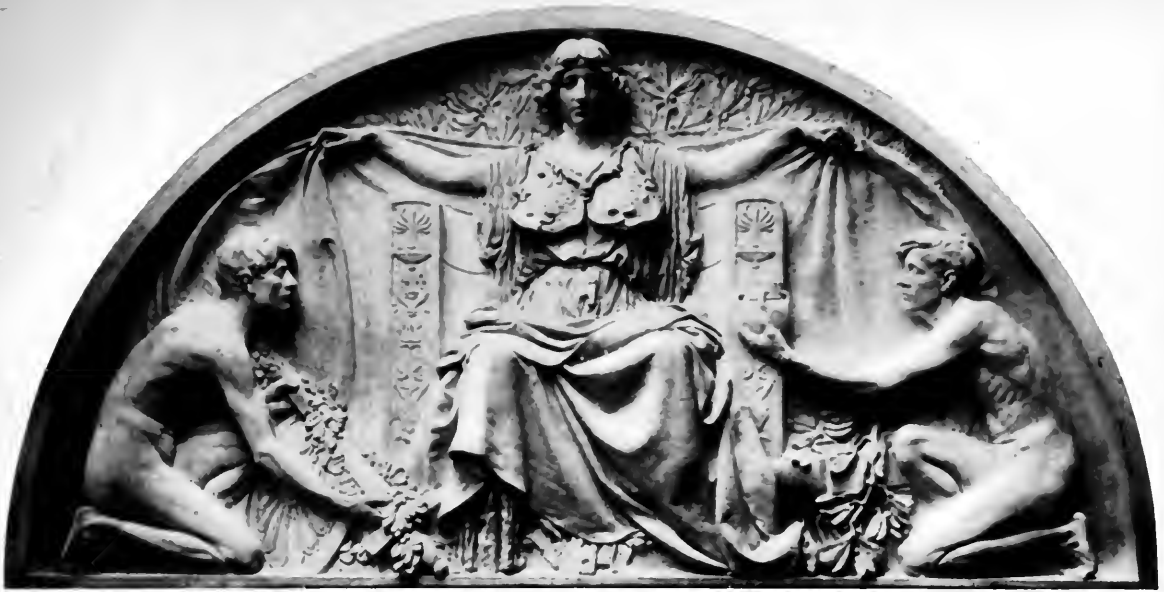

A TRIBUTE TO PEACE—Lunette on McKinley Memorial at Canton, Ohio. Central figure of "Peace" bearing the ancient breast-plate designating the protection, wisdom, fame and guardian peace which distinguished McKinley's administration—The two figures under her mantle are "War," a youth full of ardor laying down his arms at her feet, and "Industry"—By C. H. Niehaus. Sculptor

Sculpture in America

AMERICA is witnessing the dawn of its Age of Art. The foundation has been strongly laid for its magnificent material upbuilding; the ugly lines in its structure of finance are being remodelled and its great pillars of civic purity are re-set on solid rock. It is the beginning of an epoch of poets who will sing of strength of American manhood; of painters whose brushes will tell the story of American virtue; of sculptors whose genius will create from stone tributes to Fidelity, to Truth, and to Justice—to all lives

consecrated to the service of God and Man. Americans are feeling the inspiration of Art. The voice of the people—North, South, East and West—is calling upon the genius of the sculptor to idealize their conception of courage and daring and achievement. The year now closing has given truer encouragement to sculpture than any other twelve-month in American life. In recognition of this new aestheticism, especially as it relates to men and events of historic eminence, reproductions of some of the year's work of sculpture in America are presented in these pages and dedicated to the mission of Art.



PROSPERITY—Pediment by C. H. Niehaus at Kentucky State Capitol

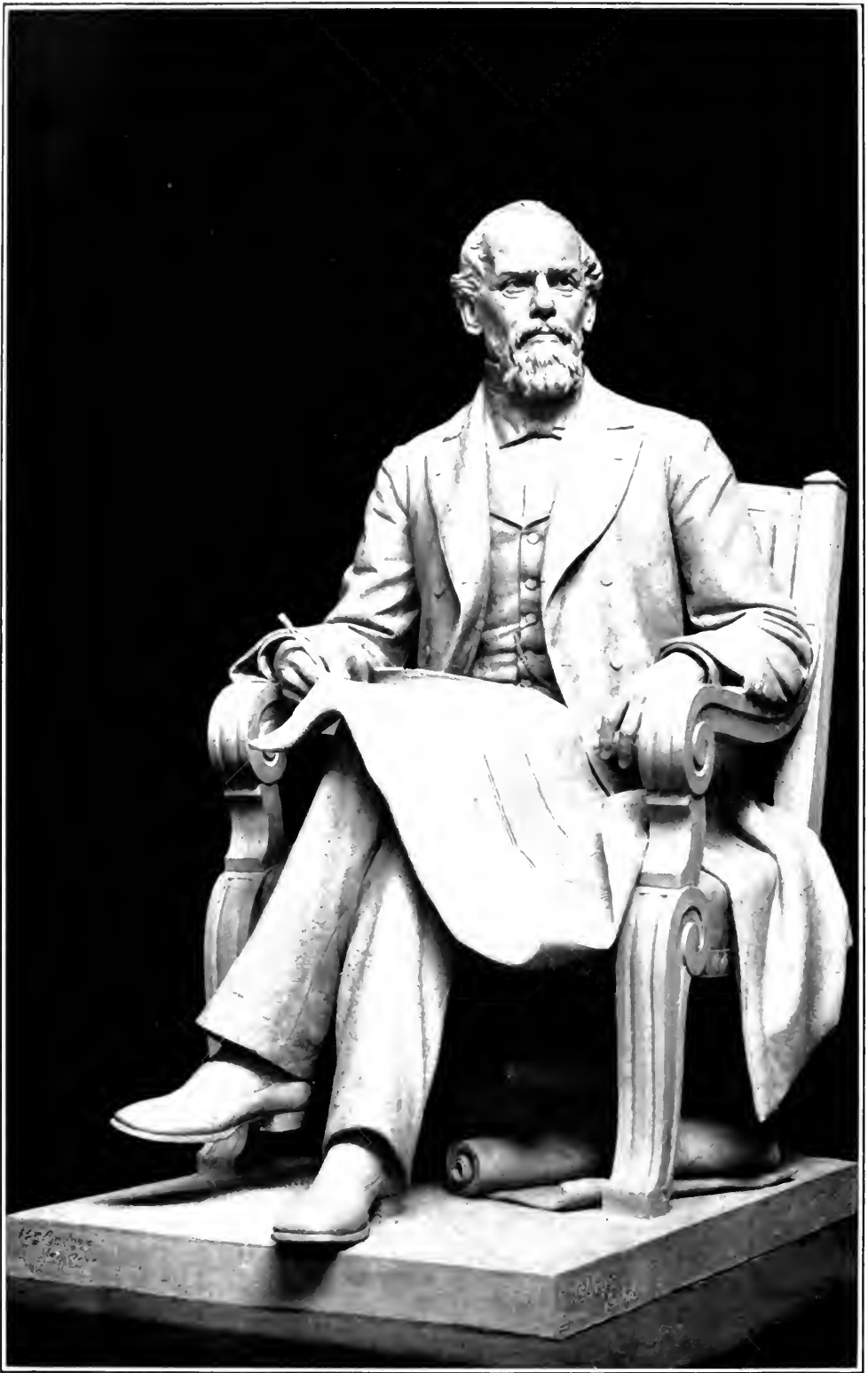

TO THE MEMORY OF A GREAT AMERICAN MATERIALIST—Colonel John A. Roebling, First Engineer of Brooklyn Bridge—Builder of the Great Span across Niagara Falls—By William Couper, Sculptor—For Erektion at Trenton, New Jersey

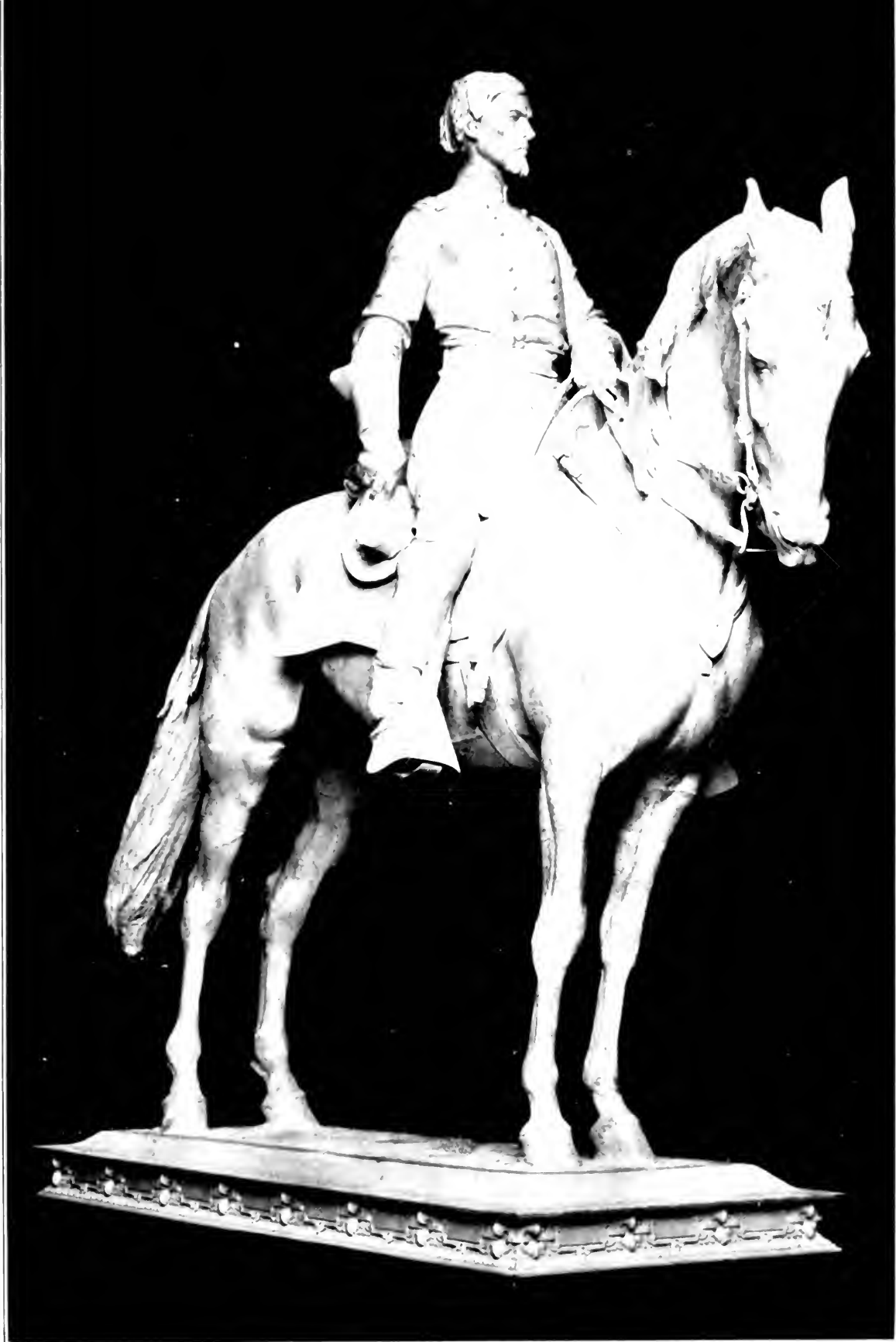

TO THE MEMORY OF A GERMAN AMERICAN SOLDIER - General Fran. Sigel.
By Karl Bitter, Sculptor - For Riverside Drive, New York City



TO THE MEMORY OF THE TEXAS RANGERS—By Pompeo Coppini, Sculptor—
Erected at the State House in Austin, Texas



603
**TO THE MEMORY OF AMERICAN SACRIFICE—By Bela Lyon Pratt,
Sculptor—Erected at the old Andersonville Prison
grounds in Georgia**



TO THE MEMORY OF THE AMERICAN SOLDIER—
By Finn H. Frolich, Sculptor—For the Monument
to Soldiers and Sailors at Webster,
Massachusetts



TO THE MEMORY OF THE AMERICAN SAILOR—
By Finn H. Frollich, Sculptor—For the Monument
to Soldiers and Sailors at Webster,
Massachusetts

665.



TO THE MEMORY OF AN AMERICAN WARRIOR—General George Brinton McClellan—
By Frederick MacMonnies, Sculptor—Erected at Washington, District of Columbia



TO THE MEMORY OF THE DISPATCH RIDER OF THE WAR FOR AMERICAN INDEPENDENCE—
By Frank Edwin Elwell, Sculptor—Erected at Orange, New Jersey

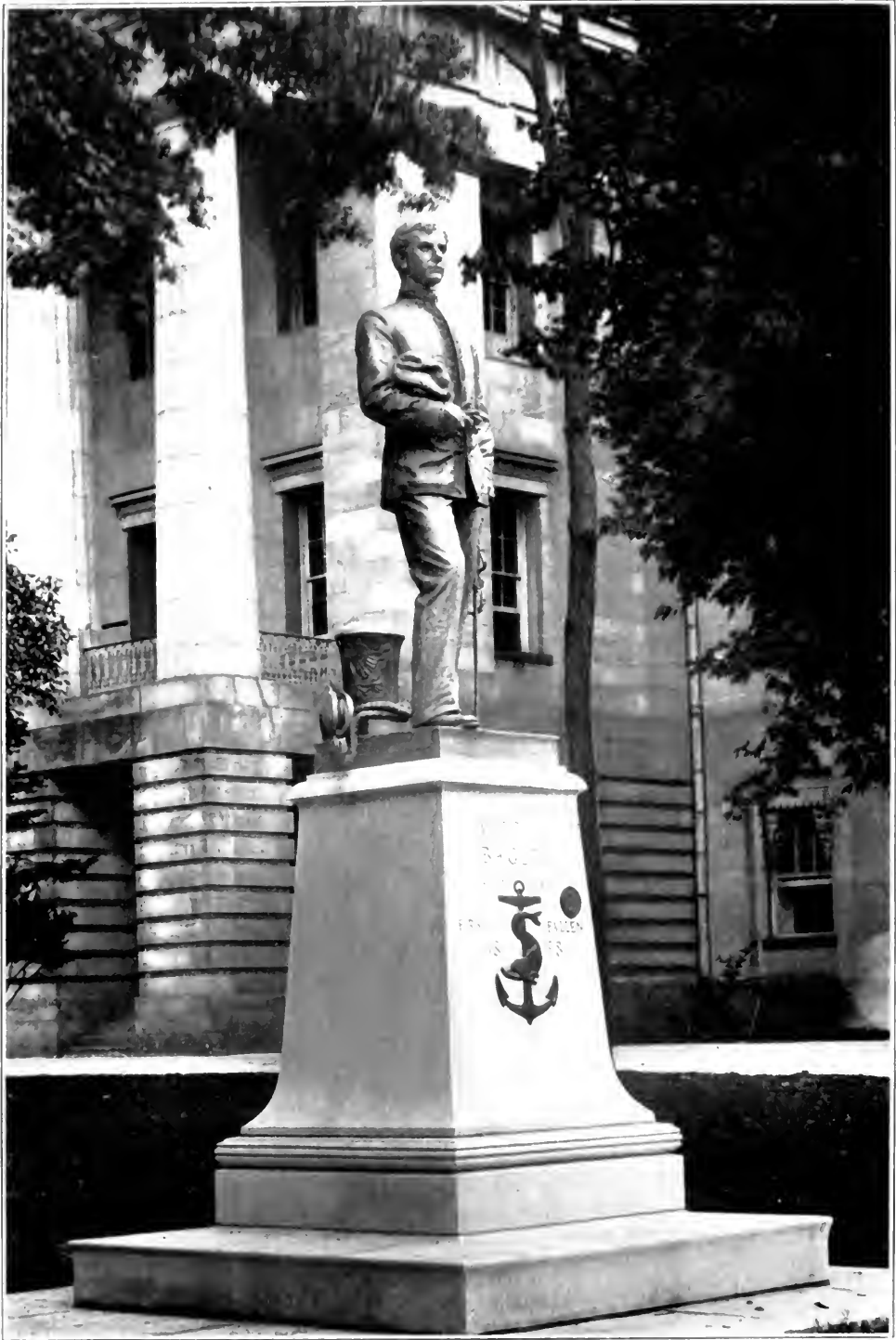

TO THE MEMORY OF THE FIRST FALLEN IN SPANISH-AMERICAN WAR—
Ensign Worth Bagley, U. S. N., the only Naval Officer killed during
that war—By F. H. Packer. Sculptor—Erected in
Capitol Square, Raleigh, North Carolina

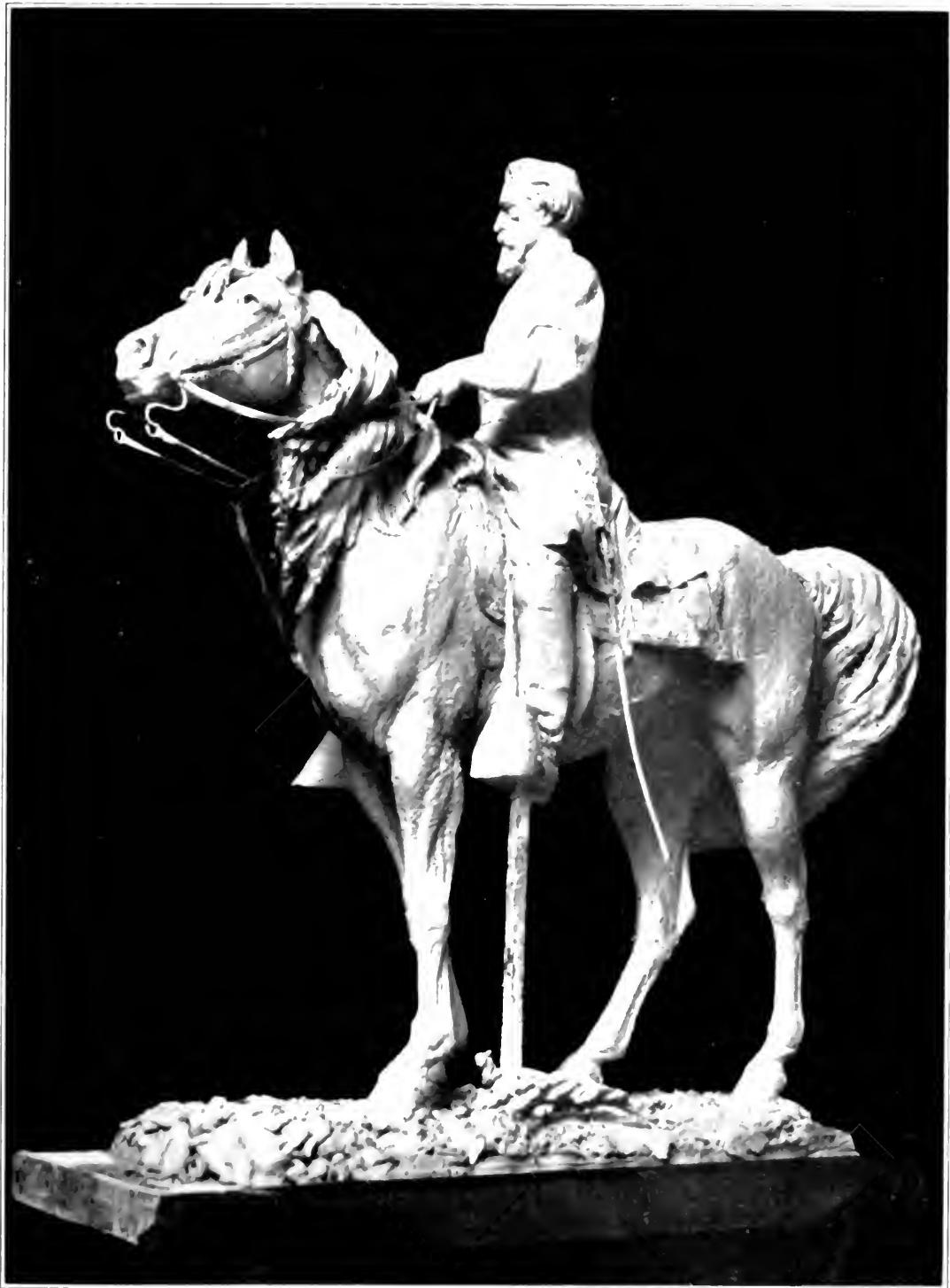

TO THE MEMORY OF A SOUTHERN WARRIOR—General John B. Gordon By Solon H. Borglum, Sculptor—Erected at State Capitol Grounds at Atlanta, Georgia



TO THE MEMORY OF THE MARTYRED PRESIDENT—William McKinley—
By Charles H. Niehaus, Sculptor—Erected in bronze in front
of the National Memorial at Canton, Ohio



TO THE MEMORY OF A ROUGH RIDER WITH ROOSEVELT AT
SANTIAGO—Captain "Buckey" O'Neill—Killed in
Battle—By Solon H. Borglum, Sculptor—
Erected at Prescott, Arizona

611-

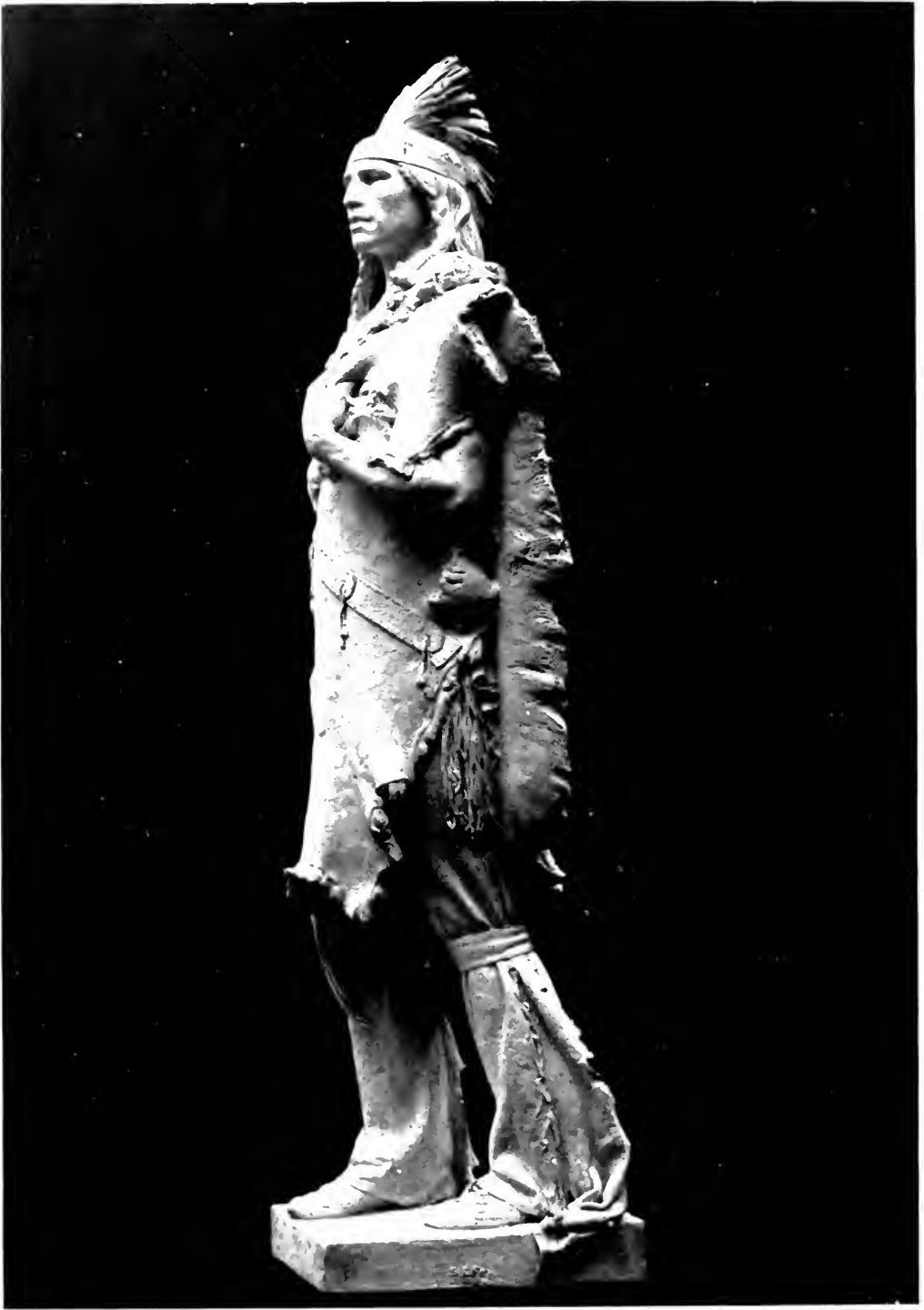

TO THE MEMORY OF THE FIRST AMERICANS—Statue of the Indian Chief,
Mahaska By S. E. Fry, Sculptor—Now being exhibited in the Salon
at Paris—To be erected at Oskaloosa, Iowa

Anniversaries of the Americans

One Hundredth Anniversary of the Birth of Whittier the Poet & Two Hundredth Anniversary of Birth of the Mother of Washington & One Hundredth Anniversary of Washington Irving's "Salmagundi" and William Cullen Bryant's "Embargo" & The Half Century Anniversary of the "Atlantic Monthly"

THIS is the one hundredth anniversary of the founding of one of the first literary periodicals in the American Republic, by one who is frequently considered the first great American of letters. One hundred years ago, Washington Irving, a youth of twenty-four, established, in 1807, the "Salmagundi" along the lines developed by Addison's "Spectator." Associated with him were his brother, William Irving, and James K. Paulding, who was a facile essayist and humorist. Literature did not prove a profitable trade in America and the journal was short-lived. Irving abandoned intellectual pursuits, but, after failures in the mercantile world, returned to literature when it had become more acceptable to the American people. One hundred years ago, there were but few periodicals in America, and they were struggling for a bare existence. The first attempt to establish an English newspaper in America was intended as a monthly, in Boston, in 1690. It carried the dignified title of *Publick Occurrances, both Foreign and Domestic*, and was immediately suppressed by the authorities. The first weekly newspaper printed in North America was the *Boston News Letter*, which appeared in 1704. The first daily newspaper in America was *The American Daily Advertiser*, published in Philadelphia in 1784. The first American literary periodical was *The American Magazine* in 1741. Three days later, Franklin issued his *General Magazine*. Both publications were destined to become early failures.

This is the one hundredth anniversary of the birth of the American poet, John Greenleaf Whittier. The centenary will be observed by the literary culture of America on the seventeenth of this December. Whittier was born at Haverhill, Massachusetts. His parents were Quakers, and he was reared on a farm until his eighteenth year. When twenty-two years of age he became editor of *The American Manufacturer* at Boston, but one year later, accepted the editorship of the *Connecticut Mirror* at Hartford. It was here that he began the culture of his poetic genius, and entered the hearts of the American people. The beloved poet died at the grand old age of eighty-five years, at Hampden Falls, New Hampshire. Shortly before his death, he told a friend that he had written about five hundred poems. The first collected edition of Whittier's poems was published just fifty years ago. To his memory these lines from his own pen are recalled:

"But still I wait with ear and eye
For something gone which should be nigh,
A loss in all familiar things,
In flower that blooms and bird that sings,
And yet, dear heart! remembering thee,
Am I not richer than of old?
Safe in thy immortality,
What change can reach the wealth I hold?
What chance can mar the pearl and gold?
Thy love hath left in trust with me?
And while in life's late afternoon,
Where cool and long the shadows grow,
I walk to meet the night that soon
Shall shape and shadow overflow.
I cannot feel that thou art far,
Since near at need the angels are;
And when the sunset gates unbar,
Shall I not see thee waiting stand,
And white against the evening star,
The welcome of thy beckoning hand?"

Anniversaries of the American People—1907

THIS is the two hundredth anniversary of the birth of the mother of "The Father of Our Country," George Washington, the first president of the United States. The bi-centennial is observed by the first families of the South who treasure the memory of this good woman. Mary Ball was born in Virginia in 1707. At twenty-three years of age, she became the second wife of Augustin Washington, whom she married in 1730. She was left a widow with six children in her thirty-sixth year. In prudence and tenderness she led them to the beauty of maturity. Her great mother-heart returned to its Creator in the joy of having lived to know the fullest blessings of life—the mother's joy of knowing that her children are living in honor and veneration. She died in the splendor of her eighty-second year, having witnessed a few months previously the magnificent spectacle of her oldest son chosen as the first great leader of the world's first republic. There is an interesting story that may be appropriately related at this time: Mother Washington, when her son George was fourteen years of age, consented to his joining the English Navy. The boy's baggage was actually put on board of one of the king's ships, anchored on the Potomac, when the mother's heart failed her, and she plead with him to remain on American soil. It is interesting to conjecture what might have resulted if her counsel had not prevailed. It is very probable that the environment and friendship of the English Navy would have made him as loyal to the crown as he later proved to American liberty. It is even possible that as an English naval officer he might have fought under the king's colors in the American Revolution. Another interesting bi-centennial anecdote was brought to light a few days ago. It relates to the first public recognition of George Washington, and was writ-

ten by an English army officer under the ill-starred General Braddock. The appreciation was published in Scot's *Magazine of Edinburgh*, in 1757, a year after the famous defeat. The officer who wrote the letter said that the entire command would have been annihilated if it had not been for the bravery and sagacity of Major George Washington and Captain Stephen Rozzell Donohoe, of the Alexandria rifles. A faded copy of this magazine is exhibited with pardonable pride by the seventh Stephen Rozzell Donohoe, who is now the editor of the county paper at Fairfax Court House, Virginia. The greatness of Washington was due largely to the strong character molded by his beautiful mother. In recognition of this devoted American woman, the American people bow in reverence on this bi-centennial of her birth.

One hundred years ago, the American poet, William Cullen Bryant, first won distinction by his poem "The Embargo." The year 1807 was one of political turmoil. The victories of Napoleon were threatening the future of the Western Continent. It was generally believed that he intended to force America to bow to his sovereignty. Aaron Burr was indicted for treason and it was freely predicted that the end of the American Republic was near. Bryant, then a boy of but thirteen years, caught the spirit of the times, and won his first distinction. Twenty one years later, he became the editor-in-chief of the *New York Evening Post*, which for fifty years he endowed with the literary individuality which it still maintains.

This is also the fiftieth anniversary of America's minister of literary culture, the *Atlantic Monthly*, which was established in the fall of 1857. During the last half century, the venerated *Atlantic* has gathered about it the literary genius of the epoch and has done distinguished service to American letters and intellectuality.



ONE HUNDREDTH ANNIVERSARY OF THE FOUNDING OF THE "SALMAGUNDI," in 1807—One of the first literary periodicals in the American Republic, modelled upon Addison's "Spectator," under the editorship of Washington Irving who gathered about him the literary culture of the Nation—Reproduction from an old engraving after a painting by Alonzo Chappel—Likeness from a daguerreotype in the possession of the family of the distinguished litterateur

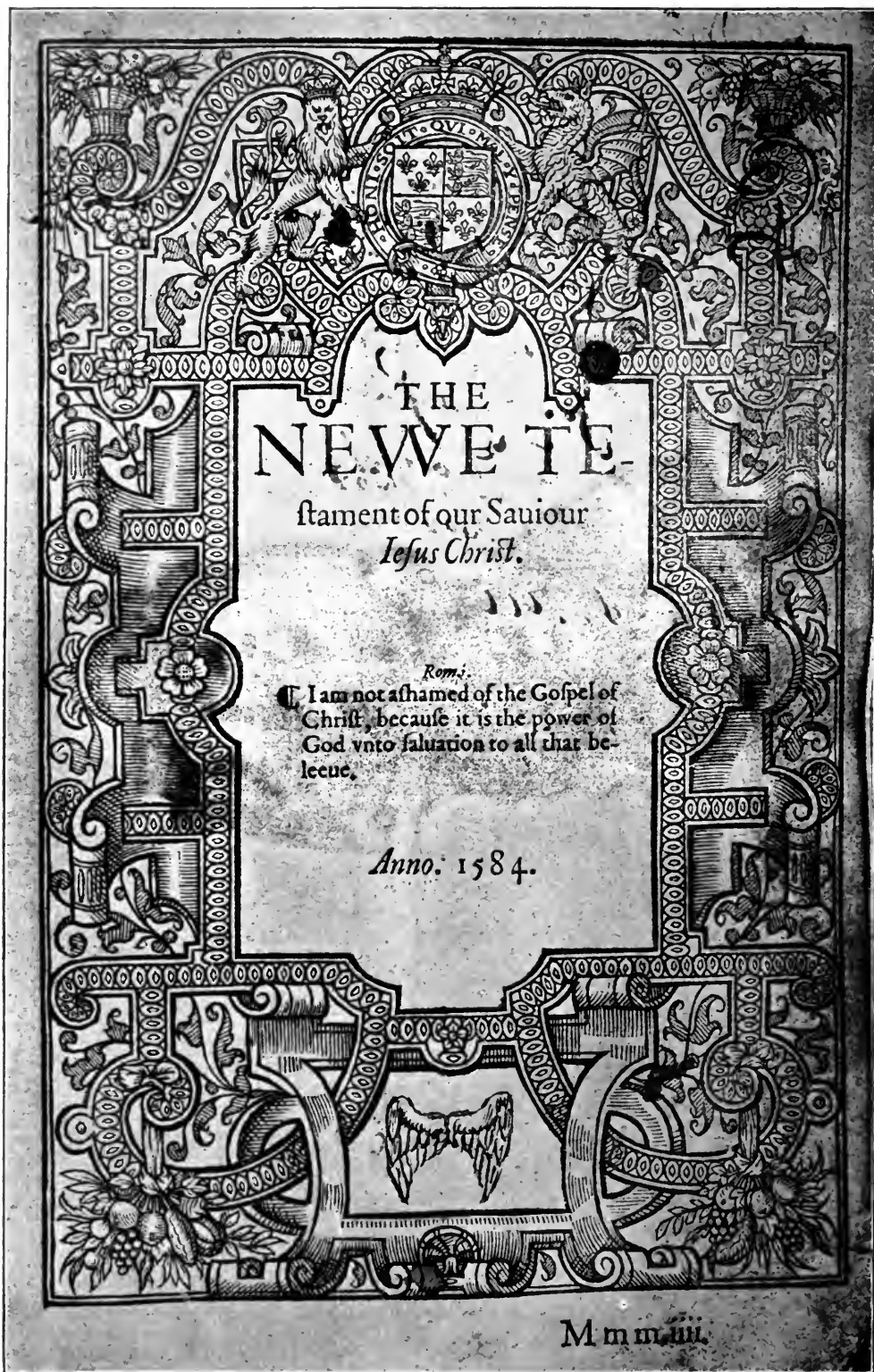

PHOTOGRAPHIC REPRODUCTION OF THE TITLE-PAGE OF FAMOUS OLD "BISHOP'S BIBLE"—
Published in 1584, and still in possession of Seymour Family in America—A survival of earliest book-making

Across the Continent in a Caravan

Recollections

of a Journey from New

York through the Western Wilderness and

over the Rocky Mountains to the Pacific in 1846 *

Adventures with the Indians * First Discovery of Gold * First

White Child Born in California * Experiences of Captain Joseph Aram

BY

COLONEL JAMES TOMPKINS WATSON

CLINTON, NEW YORK

MEMBER OF THE AMERICAN HISTORICAL SOCIETY—THE NEW YORK STATE HISTORICAL SOCIETY—THE ONEIDA HISTORICAL SOCIETY AT UTICA

IT has been my fortune to know personally some of the first Americans to cross the continent and lay the foundation for the wonderful building of the Golden West. Among my acquaintances is the first white child born in California; also one of the first pupils in the first American school on the Pacific coast. It is to the memory of his father, who was the first signer of the old constitution of California and a member of the first legislature, that these incidents are related.

The first American emigrant wagon-train reached California eighty-one years ago, and there are but few living who remember it. It was not until the discovery of gold some twenty years later that the Land of Sunshine claimed the full attention of the world. There are a few patriachs still living who crossed the continent in the gold craze of 1849. It was three years before this that the man of whom I now write, Captain Joseph Aram, undertook the hazardous journey with his family. Reaching California in September, 1846, he camped near the Yalu river, and his wife, while engaged in doing the family washing at the river-bank, picked up some thin scales of gold the size of a ten cent silver coin. This was the first discovery of gold.

The country was being harassed from Mexico. There were rumors

that it was to be seized by England. Fremont was in command of the Americans who had proclaimed a republic. Pioneer Aram was stationed as a captain at Fort Santa Clara and here, on January 26, 1848, was born the first American child in California—Eugene Aram, who has since been identified with the development of Arizona and legal practice on the Pacific coast.

With Captain Aram's expedition, in crossing the plains, was Dr. Isbell and his wife, "Aunt Olive," who gathered the children of the wilderness under her care and, without books, instructed them by writing the letters of the alphabet with a pencil on the backs of their hands. This was the beginning of the first American school on the Pacific coast. It is a far cry from the first small beginning of our American schools in California to Stanford University and the State University at Berkeley, and yet one woman's life, and she not aged, and still wearing her years lightly, has spanned the entire development and growth of the school system of the state. Mrs. Sarah M. Cool, now residing in Los Angeles, is the daughter of Captain Aram, and as a child of ten years was a pupil in the first California school.

Mrs. Cool often recalls her experiences as a ten-year-old girl in passing through the wilds of Middle and Western America from New York to California in 1846, her acquaintance

Across the American Continent in a Caravan

with Fremont, and the memory of her father's planting the first nursery in the land now known world-wide for its wonders in horticulture.

In recently speaking of these pioneer days she said that when they arrived at the Old Mission they were welcomed by most of the ills that flesh is heir to. The floors were of earth and the fires were built in the corners of the rooms. They suffered much sickness during the first winter and were kept in a state of constant alarm by their Mexican neighbors. All

doors and windows were closed at nightfall, and all callers were refused entrance. Good bread was a luxury. The only means to crush the wheat and corn was by a hand mill or stones. Wild cattle covered the plains. A fat steer cost three dollars and you could get one dollar for the hide.

It is of her father, one of the first citizens of California, that I now relate. My life has been largely spent in the vicinity of his birth and the scenes of his boyhood days are all familiar to me.

CAPTAIN JOSEPH ARAM was born in 1810, in New York state, in a large two-story house built by his father on the south side of the old Seneca Turnpike leading from Utica to Buffalo, about five miles west of Utica, and a short distance west of the village of New Hartford, which at that time was a strong competitor of Utica in the race for supremacy. The house has recently been renovated and is a fine mansion to-day. A large meadow directly across the pike was used for the annual parade and drill of the state militia. His father, Captain Matthias Aram, who had been connected with the English soldiery in England before he emigrated to America, was skilled in army tactics and acted as drillmaster. Captain Aram's ancestry were English and Scotch. His father was a recent arrival. On his mother's side the Tompkin's branch took grants of land in Ireland under Oliver Cromwell. The Hanna branch came to Ireland in the time of King James First and settled in the north part of the island in and near Londonderry and were in that city when it was besieged by James the Second and suffered great hardships. The Hanna family later located in Kings County, of which the Honorable Nathaniel Hanna was sheriff about 1760 to 1770. The un-

settled condition of the country led them to consider discretion the better part of valor and about 1770 the several branches of the family joined Sir William Johnson's Colony at and near Johnstown. Captain Aram's branch, led by his great-grandfather, the ex-sheriff, joined the Colony of Bishop Emburg and settled in Cambridge, Washington County, in 1770. At the little hamlet of Ash-Grave they built their church in 1788, which was the second Methodist Church built in America.

They came to a country just entering into the throes of a bloody Civil War. Like all other families, they were divided in their ideas of loyalty to king or colony. I find it a difficult matter to trace the war record of the family during the Revolution. I do not find that any of them distinguished themselves by acts of valor on either side. A few of them found it expedient to move to Canada, but I think the greater part kept quiet as possible or "sat on the fence." They were too recent arrivals to have very much sympathy with, or for the Dutch settlers of the Mohawk Valley.

Mrs. Sara Tompkins, daughter of Nathaniel Hanna, esquire, and grandmother of Captain Joseph Aram, was born in Ireland, 1759, died in Westmoreland, New York, 1847. She lived a long and useful life and left six gray-headed sons and daughters to mourn her loss. She was truly a



OLD PRAIRIE SCHOONER AND STAGE COACH OF FIRST DAYS IN THE WEST—Photograph taken of two ancient relics of early American pioneer life—Originals are at Sutter's Fort in Sacramento, California, which is maintained as a museum by the Native Sons and Daughters of the Golden West—The stage coach is riddled with bullets through its encounters with early outlaws and pioneer highwaymen

faithful and true American mother.

The boyhood of Joseph Aram was much like that of your father's and mine. There was the post-rider and the stage; the grist-mill was the pivot of industry; the tavern and meeting-house were the social centers. The savage West was more impenetrable than the Africa of to-day, but young Aram had a longing to blaze his way through its wilds, and laid preparations for the hazardous undertaking.

It was on the first day of May, 1846, that he joined his little company of friends at a place called Independence, on the same side of the river, to prepare for their long and hazardous trip. They lost but little time in making the necessary preparations for an early start on the long journey. Here they were joined by two men by the name of Taggart who accompanied them to California. Captain Aram spared no pains in rigging his wagon to make it as comfortable as possible; by extending the wagon bed one foot over the sides to give more room, he procured bows of a proper shape for forming the cover, which was overlaid with half inch lumber nicely fitted over the bows, and then covered with oilcloth, making the top water-tight;

the sides were covered with heavy canvas that could be tightly fitted down to exclude the night air when desirable. He had a small cooking-stove in the rear end of the wagon which answered a good purpose by keeping everything dry in the wagon, as they had much rain during the month of May. In traveling through Iowa they pursued a southwesterly course, as they intended to cross the Missouri river at St. Jo. After traveling a few weeks they struck the Mormon trail. It will be recollected that the people of Illinois had become so dissatisfied with the Mormons at Nauvoo that they gave them notice that they must leave by the twenty-second of February or take the consequences that might follow should they not heed the warning. The Mormons left, perhaps thinking that discretion was the better part of valor. They soon struck their trail; they had cut up the road in a horrible condition, making it almost impossible for the company to follow as the road was so deeply rutted; they soon found the camp where the Mormons had remained as long as their teams could find anything to subsist upon; many trees were cut down to furnish browse

Across the American Continent in a Caravan



FIRST SIGNER OF FIRST CONSTITUTION OF CALIFORNIA—Captain Joseph Aram, leader of the Aram expedition over the continent from New York to California in 1846—Portrait taken when he was sixty years old—Now in possession of his daughter, Mrs. Sarah M. Cool of Los Angeles, California

for the cattle; the horses had been tied to trees until they had eaten the bark from them as high as they could reach.

In traveling in their wake they found it unpleasant as the inhabitants looked upon them as Mormons and would decline selling them such articles as they needed for their teams. On denying being Mormons, "Oh, you all say so," was their reply. But when told that they had money to pay for what the party needed, they would reply that the Mormons had no money and it looked as though they were telling the truth, for the Mormons always wanted to work for what they got. Aram's party were several days following their trail before they reached

the great camp. They were quite surprised to find such a large body of people with their hundreds of wagons and the quantity of horses and cattle scattered over the broad prairie trying to find a little grass, as the season was quite backward. Aram and his party passed by seemingly unobserved; as they mingled in the great throng they doubtless supposed they were a part of the great company that had just arrived; it was a matter of much relief to be well clear of the Mormons. And they were careful that they should not know that they were not of their kind of people. The Mormons had brought with them cannons and a large quantity of small arms. It was thought it would have been better to have brought more flour for their starving children in the place of cannons. The Mormons remained where they were in Western Iowa and raised crops that year and did not reach Salt Lake until 1847. The rains had been very heavy, which made traveling quite slow. The Aram party soon joined with other emigrants, Dr. I. C. Isbel and family, James Isbel and family; soon after, a man by the name of Savage with a large family. Passing through the northern part of the state of Missouri they had several acquisitions to their company, numbering in all about twenty wagons. They found the streams very high; coming to a small river with full banks and with no ferry, it looked as though they would be obliged to wait for the water to fall. The stream ran through a very narrow channel, with heavy timber on both sides. They hit upon a plan of falling two quite large trees across the stream, about twelve feet apart, then cut poles and bridge the stream. The oxen were forced to swim over, and by the help of a long rope that they had brought with them, making it fast to the tongues of the wagons, with the help of the oxen on the opposite bank and with the help of the men to steady the wagon on the tottering bridge were enabled to get all safely over. It was a tedious job,

Over the Rocky Mountains to the Pacific

but better than to wait for the water to fall. They then took the road leading to the Missouri river. Arriving at the crossing at St. Jo, they laid in their last supply of provisions. The next day they ferried across the Missouri river and commenced their long journey through the Indian Territory. It seemed a wild country to them as they could see nothing but Indians, and fell in with a large party of Sioux and Foxes, Blackhawk's men. Charles Imus, who had been in the Blackhawk War, had quite a chat with them, as some of them spoke good English. They were mounted on ponies with fine trappings. A few days after that the party struck the Platt river, and had no sooner got settled in camp than a band of about fifty Pawnee Indians, that had been out on a buffalo hunt, came and pitched their tents near them; the party was not pleased with their company. The Indians came to camp, bringing dried buffalo meat as a present to them, but they failed to relish the present after its being handled by those dirty-looking creatures. Aram gave his share to the dog. That evening the Indians came to their camp and gave a war dance, accompanied by their kind of music; they were continually begging. The emigrants immediately began to pack up everything for an early start; to their great surprise many articles were missing. They well knew that the Indians must have taken them. The old chief was in camp begging as usual; they told him that many articles had been stolen by his men; he stoutly denied it. Aram had a Frenchman with him that could speak their language; he demanded of the chief that the stolen property should be returned, which he positively refused; finally he said that if they would give him a quantity of flour, indicating with his hands how large a pile would do, he would try and make the boys bring the property back. Roubedou, the Frenchman, advised them to make a prisoner of the chief and to threaten to turn him



WOMAN WHO FIRST DISCOVERED GOLD IN CALIFORNIA—Mrs. Sarah Ann Aram, wife of Captain Joseph Aram, who with her ten year old daughter pursued the hazardous journey with her husband—Mother of first American child born in California—Portrait taken when fifty-nine years old

over to the Sioux, as they were at war with that tribe. The party took his advice and seized the old chief and pinioned his arms behind him. The old fellow began to think that he had got into a tight place; he sang out at the top of his voice for his men to bring everything back, and in less than five minutes every stolen article was returned. He was given his liberty and the party were soon on their way.

I will now leave the narrative of the journey to Captain Aram, who in his own journal relates many interesting anecdotes. The ancient manuscript is still preserved by his children, and it is with their permission that this transcript is taken:



WHERE COMMODORE SLOAT FIRST RAISED THE AMERICAN FLAG OVER CALIFORNIA—Old Custom House at Monterey where the Constitution of California was formulated and the Stars and Stripes proclaimed it to the world as the Golden Gate to the American Republic as related in Captain Aram's journal



WHERE JOHN MARSHALL IN 1848 BROUGHT THE NEWS THAT HE HAD DISCOVERED GOLD IN CALIFORNIA—Historic Sutter's Fort, in Sacramento, California, before its recent restoration by the Native Sons and Daughters of the Golden West who have now transformed it into a museum of relics pertaining to the history of Western America—Captain Aram tells of this old fort in his historic journal

The Reminiscences of Captain Aram

Life Story of a Pioneer of the Great West as Related Shortly Before His Death, in His Eightieth Year & Accurate Transcript from the Journal Now in Possession of His Children in California & Early Days on the Pacific Coast

AFTER describing the details connected with the organization of the journey from New York to California in 1846, and the adventures through the Middle West until their approach to the Indian Territory, Captain Aram makes these notes in his journal. The ancient manuscript is a valuable contribution not only to the historical literature of the West but of the entire American Continent, for in it are the keen observations of a man who led the way to the Pacific, who knew personally many of the pioneers, and who lent his hand, heart and head to the establishment of a great Western Nation:

Our company was getting to be quite large, where there are many men there is apt to be many minds. It became necessary to elect a man to take the command of the company, they elected Charles Imus as their captain, he having had some experience with the Indians in the Black-hawk war. His services proved to be of much value to the company. We fell in with an old mountaineer, Kit Carson, that had spent most of his life with the Indians, he offered to pilot us to California for a nominal sum of money and a stipulated amount of provisions, he being familiar with the whole country through which we had to pass, we closed the bargain with him which proved to be of great service to the company. On arriving at Laramie fork of the Platt river which we found rather high for the wagon beds, we found that by blocking up about one foot we could pass over without damaging our goods. To test the depth of the water one of the company rode through the river on horseback. As soon as over

the stream we were in the vicinity of Fort Laramie, where we found a large body of Sioux Indians in camp. They seemed to be very friendly and were the best behaved Indians that we found on the whole journey, during the time that we were cooking and eating our meals, a man would come through the camp and drive all the women and children away; the chief told us that the women could come and trade with us as much as they pleased, but they were not allowed to hang around our camp while we were cooking and eating; but how different we found it with other tribes, for even the chiefs would come about and beg for something to eat. The captain of Fort Laramie told us that it would be a good plan to give them a treat of coffee and biscuit. It would secure their friendship. Every family set to work to make preparations for it. When all was in readiness, the ladies spread their table cloths in a long line on the grass sufficient to entertain the number reported. The food was spread on the cloth, and at a signal given the Indians took their places; there were about two hundred of them at the table. To our surprise every tenth man helped the nine sitting at his left, no one offered to help himself but was waited upon by the appointed one. They drank about two cups of coffee apiece and ate generally not more than two biscuits each. Then the women and children came forward and cleaned up what was left. That evening the young men and women came to our camp dressed in their gayest attire and gave a splendid dance. With their music and singing, there was some degree of refinement in it all, which was more than we expected to find amongst Indians. The next day we moved forward

Across the American Continent in a Caravan

toward the Black Hills. The country was swarming with countless herds of buffalo, all seemed to be wending their way northward. Sometimes it was difficult to keep out of their way. They always seemed intent on pursuing their own course, regardless of any obstruction that might lie in their way. The bulls always travel in front of the band, the cows next, with the calves in the rear. When we would camp for a day or two we would kill a few of them and dry the most suitable part of the meat for our use. It was much relished by us all. On reaching the waters of the south Platt river we found the waters rather deep for our wagon beds so we were obliged to block them up sufficiently high to save our goods. We crossed with but little difficulty. Found buffaloes in great abundance. After we left the river some three or four miles, we discovered a great band of buffalo running toward us in great fury. We lost no time in unhitching our teams and getting them on the opposite side of the wagons. They rushed by us but generally between the wagons. One very large bull ran his head under the wagon of Mr. Hecox and raised it off of the ground, and when it fell it came down with such force as to break the hind axletree. We managed to kill two buffaloes before they all got away from us. On account of the accident the company came to a halt, and had to go several miles to get a pole to put under the axle, that the wagon might be hauled along until timber could be found to make a new axletree, the other wagons took on most of his load so that we could move on. Buffalo was in sight in every direction. We occasionally would kill them when we needed fresh meat, but not for sport as many have done. We passed over a beautiful country mostly prairie until we reached the north Platt which we forded without difficulty. Then we commenced the ascent of the Rocky Mountains. It was a gradual rise for several day's travel. When

we reached the summit we found a crest of rocks about eight rods in width, with sharp edges standing upwards. We looked out for the best place for crossing, and by using our picks and axes we smoothed them down a little, but it was rough work for the oxen's feet and the wagon tires but we got over without much difficulty or damage. We then descended into the Sweet-water country. Found plenty of buffalo there but was told by our pilot that we would not find any after leaving the Sweet-water. We concluded to make a halt for a short time in order to kill and dry what meat we needed. In the stream we found an abundance of mountain trout. We feasted on them for a change of diet. We then commenced to kill and dry our meat. We built scaffolds of willow poles, with a fire under them and with the benefit of the sun it was dried sufficiently to keep, in two or three days time. Then we pushed forward, and occasionally we found long drives without water. In such cases when there was a moon we would drive by night. The teams could endure the thirst better than in the day time, as the sun and dust was almost unbearable while crossing the alkali plains. After leaving a stream known as Big Blue, and learning that we were to have a long drive without water, we remained at the stream until about three o'clock in the afternoon, when we started for the geysers or hot wells, arriving there about daylight in the morning. They consisted of five flowing wells, throwing out quite a large stream of boiling water, at times they would throw the water fifteen feet high, at other times they would be quite calm. We took breakfast there using the water for cooking purposes. The flow of water was sufficient to form quite a large stream. It was so hot that we were obliged to drive two miles down stream before we could venture to cross it on account of the intense heat, fearing that it would injure the oxen's feet.



FIRST BRICK HOUSE IN CALIFORNIA AND OLD WHALING STATION



AMERICAN FLAG ON THE FIRST CAPITOL OF CALIFORNIA—Colton Hall at Monterey where Constitutional Convention was held that made California a free state—Captain Joseph Aram, writer of the journal herein recorded was a member of the Convention and the first signer of the Constitution



FAMOUS OLD CARMEL MISSION BUILT IN 1770 AT MONTEREY, CALIFORNIA—This was one of the first places where Captain Aram visited on his expedition across America as recorded in his entertaining journal



FIRST THEATER BUILDING IN CALIFORNIA—A type of the ancient adobe structure in old Monterey—It is said that the famous Jenny Lind on her first tour to the Pacific Coast in the fifties sang in this structure

Reminiscences of Captain Joseph Aram

We then passed on to a broad plain. During that day we saw a large number of Indians on horse back, about two hundred coming towards us at full speed and yelling loudly. We instantly formed a circle with the wagons as a breast work. As they came near Captain Imus advanced a few rods in front of us, with rifle in hand, motioned for them to halt. They obeyed instantly, he motioned for the chief to advance. He came a few steps forward, the captain laid down his gun, then motioned for the chief to do the same. They advanced until they met, then shook hands. The chief told him all they wanted was to purchase guns. He was told to bring ten men to our camp and no more. He brought the men. Our captain placed a strong guard in front of our wagons. There was but little doubt at the time, that the prompt action of our captain saved us trouble. They were of the Bannock tribe. We were very glad to get rid of their company.

A few days later we fell in with a large party of Cheyennes. They were carrying the United States flag. We thought it looked a little like civilization. We came in sight of the Chimney Rock, a tall spire that could be seen at a great distance in that transparent atmosphere. In that vicinity we found a large quantity of wild currants. We gathered all that we needed, they were quite a treat to us. They were found on the creek bottom. The Indians were quite friendly. We were told by our pilot that a long drive without water would reach Green river. We drove in the night but did not reach the river until nearly noon next day. Our oxen were so famished with thirst that they would have rushed into the water, wagons and all if they had not been prevented. Here we waited a few days. While there several emigrants arrived; the Donner party was amongst them. While there Captain Hastings arrived from California by way of Salt Lake. He advised us by all means to go that way, assuring us

that we would save a month's travel, but our old pilot, Greenwood, who was familiar with the country, told us that it would be much safer to go by Fort Hall. After much talk many of the emigrants took Hasting's advice, particularly the Donner party. It was a fatal mistake for them. We had a very good road to Fort Hall, it being the advice of our pilot Greenwood. From there we passed to the head waters of Goose creek. In that vicinity we came to the forks of the road. One leading to Oregon and the other to California. Many of our company turned toward Oregon, leaving us only about twelve wagons.

In passing down Goose creek we came to the Thousand Springs valley. It is well entitled to the name. There are more hot springs than we could stop to count. There is a lime deposit that forms a hard crust. In walking over it, it sounds as if it was hollow beneath. Those springs all come together forming quite a stream. Then we were guided to the head of the Humboldt, and followed it with little variation with the exception of cutting down the river banks, until reaching the sink of the stream. There are many Indians living near that stream. They are of a very low order of humanity, the most so of any we had met with. They would often come to our camp in a perfectly nude state. We found sugar-cane in large quantities on the swampy lands of the stream. The Indian's mode of obtaining sugar was quite simple. They would split the canes and lay them in the sun to crystallize the sap, then scrape out the pith or pulp, then rub it between the hands and gather it on skins. This work was performed by the squaws. When we arrived at the point where the Hastings road would meet ours, as we were told by our pilot, we made a halt as there was plenty of grass. We rode one day's ride to see if we could learn anything of the Hasting's party. All the intelligence we could get was from the Indians. They told us by signs that

Across the American Continent in a Caravan

they were a long way off, and that they had lost many cattle. We came to an Indian village, they came out in strong force but finding us friendly, they treated us kindly. They were digging roots on a creek bottom. They looked like a small red carrot. They gave us some that were cooked, they tasted like a sweet potato. They also offered us some dried crickets but those we declined, thinking they would not relish well with us.

We then proceeded to the sink of the Humboldt. We remained there three days on account of the abundance of grass, being told that it would be altogether a mountain country where feed would be scarce. The Indians there were known as Truckee. Pilot Greenwood left us there. A chief "Truckee" was anxious to pilot us into California. We agreed to accept his services. A brother of his went along with him. Chief Truckee was of much service to us as he had been in California. The last night that we remained in that camp the Indians stole five of our oxen which was a great loss to us at that time. We pursued the trail where they had been driven until we found where the oxen had been killed. As we approached the Indian village the inhabitants fled and hid in the tules. To get even with them we set fire to their houses and returned to camp. The next thing was to make up our teams for a start. To do so we had to yoke up some cows. Those used were quite large ones, they performed remarkably well. Old Truckee denied that they were his Indians that stole them, but said they were Shoshonees. We then proceeded on the road to the Truckee river. Some part of it was hard on the teams as there was little or no grass and the road was of deep, soft sand, which seemed to exhaust the teams very much. On reaching the river we let the teams rest for a day there being an abundance of feed there. In traveling up the river, we were obliged to cross it several times in one day. The stream

was filled with smooth boulders making it very difficult for the oxen to travel.

After leaving the Truckee we took the trail leading to the Sierra Nevada mountains. We had brought a number of young cattle, thinking that we might need them for meat. We killed one and divided it with the company. The two Indians begged the offal of the beef, the head, hide, and entrails. They built a good fire, cooked and ate seemingly all night. The offal had all disappeared except the horns and bones of the head. The Indians had quite a bloated appearance the next morning. If I had not seen it with my own eyes, I could scarcely have believed what I here saw for a fact.

The next day we reached the Sierra Nevada Mountains. We spent three days there exploring the mountains to find a pass where we might make a crossing. A party of us took our horses and went to the summit, and traced it both ways and finally decided on the place to make the crossing. It was quite an undertaking to get our wagons up. We put about five yoke on a wagon, and had as many men with it as was necessary to keep it from sliding sideways. Then with five yoke on the summit letting down our long one hundred and fifty feet rope, and hitched it with the leaders that were on the wagon, by this process, we succeeded in getting all the wagons up safely, and was soon ready to push ahead on our journey. Here we received the first intelligence of the Mexican War, by two young men that had been as far as Sutter's Fort. We then pushed on as fast as possible for the Sacramento valley.

Just before we reached the Yuba river the mountains became very steep, so much so that in one instance we were obliged to lower the wagon's down by locking all four wheels and taking a turn around a tree with the rope, we were able to keep the wagons from ending over on the oxen, but we

Reminiscences of Captain Joseph Aram

succeeded in getting down safely. The next night the Indians stole an ox from the company. Some of the men followed by the aid of old Truckee, but when found the Indians had the ox killed already, and being discovered they fled in all directions. The next day brought us to the Yuba river. There being plenty of grass we concluded to remain a day for the teams to rest. While there we found much bear signs, so we concluded to take a hunt. Captain Imus, Dr. Isbel and myself formed one of the hunting parties. In passing along the ridge of the mountain through the brush, a large bear charge on us. We set the dogs after him. Dr. Isbel discharged his rifle at him which seemed to make him run the faster. He soon disappeared in the brush. Not long after our dogs found two half grown bears, they seemed inclined to stay together. When they would run our little cur dogs would nip their heels as they ran, they would turn on the dogs bellowing like a bull. Eventually they separated, then the dogs had only one to attend to. They kept him at bay until I got up with him. My mastiff seeing me so close seemed to give him courage. He seized the bear by the throat, he would have been crushed very soon by the grip of the bear. I hurried up and placed the gun so close that the powder burned his hair. The next thing was what to do with our game. We concluded to make him as little as possible. We took out his entrails, and succeeded in hauling him to the foot of the mountain. We left him, marking the place well, and went to our camp, got several young men with poles and ropes to go and bring him to camp. We dressed and divided the meat with every mess in camp. It was fat and most delicious. It was relished by all of the company.

While staying in camp our women went to the river to do a little washing, while there my wife picked up a piece of gold about the size of a ten cent piece of silver. [This was a discovery of gold ante-dating that of

Marshall's. But nothing was said about it, though the specimen was thoroughly tested at the time.—Ed.]

We then proceeded on our journey. In about two days we reached Johnson's ranch on Bear creek. Just before entering the valley, John Kearney and myself took our horses and rode ahead of the company, to engage beef and have it ready by the time the company arrived. Just before getting into the plains we discovered some hogs, which to us looked more like civilization than anything we had seen for five months past. We arrived at that point on the first day of October. After resting two days we proceeded to Sutter's Fort. We received a very warm reception from Captain Sutter. He inquired if he could do anything for us. "Should you need any beef, just go and help yourselves to as much you want, and anything else that I have is at your service." We next found Fremont camped on the American river. He informed us of the state of affairs that then existed in California. He told us that we had better push forward as fast as possible, as the Spaniards were unfriendly toward the Americans. He advised us to go to Santa Clara and take possession of the mission buildings. And as soon as a sufficient number of men arrived to organize a company for our own protection, elect officers to whom he would give commissions, and for us to appoint a suitable person as commissary and he would give him a letter of credit that would enable him to obtain such groceries as we would need from the government stores in San Francisco.

We then pushed on towards San Jose, but before we had got half way there, we met a courier from San Jose, advising us to make all possible haste, fearing the Mexicans would give us trouble, but we arrived there without molestation. As we arrived in San Jose the people looked upon us with as much surprise as if we had dropped from the moon. After resting for a time, Mrs. Captain Hanks

Across the American Continent in a Caravan

presented each family with a loaf of bread. We then proceeded to Santa Clara, where we found the mission buildings in a very dilapidated condition as well as filthy. Seeing no other alternative, we set ourselves to work cleaning the buildings, in order to make them as comfortable as possible for our families. The rooms having nothing but earth floors and no chimneys, we generally built the fire in one corner of the room, and let the smoke find its way up and through the tile roof as best it could. In consequence of the heavy fall of rain that winter, the buildings became quite damp causing much sickness to the families and many deaths. The commissary was only able to obtain a scant supply of groceries, flour or bread was almost out of the question. But there was plenty of wheat in the country. A Spaniard by the name of Alviso, living in Santa Clara, who was friendly to the Americans, and really rejoiced in the prospect of California becoming a part of the American Government, came nobly forward and furnished wheat for the benefit of the families. They procured a large steel coffee mill to grind the wheat with. The sound of the mill could be heard almost all day and night, as there was over thirty families dependent upon the use of the mill for their bread, unbolted as it was but they were but thankful to get even such.

After the menacing of the Spaniards became alarming, the men held a meeting for the purpose of organizing a company for mutual protection. There were about thirty-three men signed the roll. The next thing was to elect officers. The result was as follows: Joseph Aram, Captain; Steven A. Wright, First Lieutenant; G. D. Dickenson, Second Lieutenant; N. B. Smith, First Sergeant. As soon as the organization was complete, it soon became evident that some kind of barricade was necessary to prevent the enemy from charging immediately on the mission buildings. Being in full command of the place, I

set the men immediately at work to fortify the place, by cutting and hauling logs about ten feet in length. They were placed in a ditch about three feet deep, forming a breast work seven feet high. We felt that such a fence was sufficient to prevent the ingress of the enemy. The very wet winter was hard on many of the families. There was over thirty of them crowded into too close quarters for comfort. The next thing was to get meat for such a number of people. The Spaniards taking good care to keep their cattle out of our way. I had offered to buy beef of them but to no avail, I offered to pay the usual price in money but yet they refused to sell me anything. They seemed to think the easiest way to get rid of us, was by stopping or cutting off our supplies and starving us out. But men who had just crossed the plains could not be bluffed off so easy. I immediately resolved on a more effective expedient to procure beef. I gave orders to the sergeant to take ten men with a wagon and go to the timber south of Santa Clara, where he would find plenty of cattle, to shoot down one of the fattest animals that he could find, dress it and bring it in. The men returned with a lot of fine fat beef. The next day the Spaniards came to make a complaint that my men had killed one of their best tame cows. I told them that we must have meat and as they refused to sell, that I had ordered my men to go and bring in beef, that the families could have something to eat. The only way to avoid a similar occurrence, would be for them to agree to deliver to us a certain amount of cattle on certain days in each week. Hereafter the Spaniard agreed to my proposition and filled his part of the contract faithfully, by delivering to us two good beeves per week during that dreary and wet winter of 1846 and 7.

Captain Sanchez had an organized company of about one hundred and fifty men and was generally hovering

Reminiscences of Captain Joseph Aram

about Santa Clara and San Jose. Provender for our horses was not to be had. We were obliged to picket our horses out in the mustard to get a little grass. There was scarcely a day but a horse would be stolen, which crippled our company very much. Captain Sanchez having a superior force as to number, kept my force of thirty-five men and Captain Weber with his twenty men continually on the alert. Many attempts were made by the Spaniards to force a way into the mission, but they were foiled in every attempt. About the sixth of January, 1847, Captain Marsten of the United States Navy with a company of marines and a small cannon, came in order to assist the small forces of San Jose and Santa Clara. Sanchez had taken several prisoners. Whenever he found a small party of Americans he would make prisoners of them. Lieutenant Bartlett, Martin Corcoran and several others were in his possession when the battle of Santa Clara took place. As Captain Marsten approached within a few miles of Santa Clara, Sanchez made an attempt to dispute his advance, firing commenced about 9 o'clock A. M. and lasted until near night. The Spaniards having superior horses were enabled to hover about the Americans at their will, but were very careful to keep well deployed as they soon discovered that the Americans did not fire at random, while the fire of the Spaniards was always very high and had but little effect. The tendency of both parties was to beat towards Santa Clara, which enabled my men to participate in the fight. But as our horses had already been stolen, we had to take the field on foot, and as we advanced towards the enemy one division of them was ordered to charge on us, they came at full speed as if they intended to ride over us. Our men stood their ground not daunted, were prepared to give them a warm reception. A volley from our rifles caused a sudden change in their movements, a hasty retreat was the

result. They rallied again for another charge, which was not as fearless as the first charge. As soon as near enough we gave them another volley, they beat a hasty retreat and we saw nothing more of them.

During the battle the main force of the enemy was contending with the forces commanded by Captain Marsten and Captain Charles Weber. But at no time during the battle could the Spaniards be drawn into a close engagement. They preferred to fight at a good distance from our lines, they seemed to dread the whizzing of our bullets. The Americans were cool and determined and anxious to get as near the enemy as possible for they always fired over our heads. As night drew near the firing ceased. The Americans withdrew from the field and camped at Santa Clara, while the enemy retired to the timber south of town. Early the next morning a flag of truce was sent from Captain Sanchez asking for an armistice. He was told that the only condition that would be granted, would be a surrender of all their arms. Captain Sanchez replied that he would rather die than submit to such dishonorable terms, but said he, "if Captain Hull of Yerba Buena says so, I will submit." An armistice of three days was granted on condition that they should not leave their camp during that time. A courier was dispatched to Captain Hull for his decision, he being the Military Governor of Upper California at the time, but he was inexorable. His reply was that they must submit to the terms exacted or fight on.

On the arrival of the courier the officers were notified to meet the American officers at a certain hour at the place appointed to hear the decision. As soon as the meeting was arranged, the decision was read and interpreted to them by Alexander Forbes. The Spaniards reluctantly agreed to the conditions, which were as above stated, an entire surrender of all their arms. The next day at nine o'clock A. M. was the hour appointed

Across the American Continent in a Caravan

for receiving them on the same ground then occupied by the officers. At the hour appointed the entire American force was there and formed a double line. The Spaniards marching in single file between them and deposited their arms as they passed. It was certainly a very humiliating sight to see one hundred and fifty well mounted men surrender their arms to less than one hundred Americans, that were very poorly mounted and many of them on foot. I made a demand on Captain Sanchez for the return of our horses which had been stolen from us. His men cheerfully assisted in lassoing the horses. We got nearly all of them back. From this time forward the Spaniards seemed anxious to cultivate a friendly feeling with the Americans. Receiving advice from Colonel Fremont, I was advised to disband my company as their services were not needed any longer, and on the first of March, 1847, I gave them their discharge from further service and shortly afterwards took my family to Monterey, with several others proceeded to Santa Cruz, stopped on the way at Soquel. While there overnight, myself and family made our beds and slept in a large, hollow red-wood tree that we found at that place. There was an abundance of room for us, and fortunately for us there was quite a drizzling rain that night and those that slept on the ground found their bed coverings were covered with frost the next morning. We remained at Santa Cruz about one month. Being very dull there, we concluded to go to Monterey as business seemed to be more lively in that place, it being the headquarters for both the army and navy. I helped to build the fort which afforded considerable business for all there that wished to work.

I remained in Monterey about two years. The gold mines of California was discovered in the year 1848. Like many others, as soon as I discovered that the mines were a reality,

I joined a company of men and went to the reported gold fields. We took with us a quantity of goods and groceries, which we found a ready sale for. We also worked in the mines with tolerably good success. Our operation that year was mostly at a place now called Placerville. I also spent the summer of 1849 in Tuolumne mines. In the fall of that year I returned to San Jose where I was making my home with my family. On my return I was solicited by friends to allow my name to be put on a ticket as a candidate for delegate to the Constitutional Convention to be held in Monterey in September of that year. I was one of the successful candidates for that position. I had the pleasure of assisting in forming the first constitution of the State of California.

After the Convention adjourned I returned to San Jose, where I was immediately solicited to run as a candidate for the legislature to be held under the new constitution and was elected to fill that position, wherein an entire code of laws had to be formed for the State of California. Was elected to a seat in the City Council of San Jose in 1850. And was elected to that office for the next three succeeding years. Was elected as trustee of the University of the Pacific at its first organization and remained as a member of that body until 1873. My wife died on the first of March of that year. I visited the Atlantic States, that I might once more see the land of my early boyhood associations. In 1876 I again visited the Eastern States, and while there married my present wife and companion of my old age, and while there we both visited the Centennial Exposition at Philadelphia and now in the year 1896 having passed my 86th birthday at the time of the writing of this narrative, am now resting with my abiding hope of a future immortality beyond this life.

JOSEPH ARAM.

Four Hundred Years of Panama Canal

First White Man
to Cross the Isthmus from
the Atlantic to the Pacific & Futile
Attempts to Find a Natural Waterway Connecting
the Two Great Oceans & First Plans Ever Made to Sever the
Americas with an Artificial Strait by Cortez in 1529 & Investigations

BY

DR. WILLIS FLETCHER JOHNSON

OF THE "NEW YORK TRIBUNE"

RESUME FROM HIS RESEARCHES RECENTLY PRESENTED AFTER MORE THAN TWENTY-FIVE YEARS' STUDY OF SOUTH AMERICAN AFFAIRS AND ISTHMIAN CANAL TRANSIT IN HIS BOOK "FOUR HUNDRED YEARS OF PANAMA," PUBLISHED BY HENRY HOLT AND COMPANY OF NEW YORK

IT is singular that people generally believe the canal project was conceived only shortly before the time of de Lesseps. The first record that I can find of the proposal to build a canal was made by Hernando Cortez, the great Spanish Conqueror, early in the sixteenth century. This restless genius, an impoverished nobleman, after conquering Mexico and Central America, was directed by Charles V to find "the strait." This strait, you know, was supposed to be a stream of water bisecting the isthmus somewhere which would enable the voyagers to find that route to the Indies in quest of which Columbus came when he unwittingly stumbled upon the new continent. It is familiar history that for many, many years the explorers, after Columbus, supposed that if they could discover the strait they would be able to find the main coast of India right on the other side. The lands upon which they carried on their operations were for years supposed to be nothing but islands. These delusions were augmented by willing misapprehension of the information given by the natives. Columbus supposed that if he could find the strait he would be able to pass through it, reach the Pacific ocean and thus eventually circumnavigate the earth when he returned home. The real pioneer of Isthmian exploration was a conquistador named Rodrigo de

Bastidas, who came, to what is now known as Panama, two years before Columbus. He likewise was in search of the fabled strait. The reason these mighty men pursued this myth so strenuously was because there were innumerable legends among the natives concerning a strait which connected the two great oceans. For that matter I have myself heard among the ferocious Indians of San Blas, who are natives in the Isthmian valley of Atrato, very confident reports of the existence of this mythical strait. Is it, then, surprising that these early Spanish pioneers should have prosecuted the search so long?

It was Balboa, another of the great explorers, who, on September 29, 1513, first crossed the isthmus, luckily at its narrowest part. He is the first white man who saw the American shores lapped by the waves of the Pacific, and the place where he strode into the water to take possession of it in the name of the king of Spain is still called by the appellation he gave it: Golfo de San Miguel. There are many illustrious names mentioned in the quest of the mysterious strait, among them De Soto, the discoverer of the Mississippi; indeed, had it not been for the search, there might have been no French colony planted in Canada. It was with instructions to find the shortest route to Cathay that France sent its pioneers, Cartier and Verrazzano. In 1529, Cortez, having lost faith in the existence of the strait,

Four Hundred Years of the Panama Canal

prepared the first plans ever made to cut through the isthmus with an artificial strait and was about to lay them before the king, when he died. After this, four different routes for the proposed canal were planned and permanent overland transportation was established by a tyrant who decimated the native population of South America from 2,000,000 to 200,000. But the canal theory was temporarily abandoned in the reign of Phillip I, about the end of the sixteenth century, because the king was convinced by a Jesuit historian that it was contrary to the Divine will to unite two oceans which the Creator has separated. Not only did he abandon the project, but he imposed the penalty of death on all who attempted to project such plans or should attempt to seek a better route across the isthmus. Hereupon follows that period of those desperate English buccaneers like the Welshman Sir Henry Morgan, who ravaged the Spanish cities upon the isthmus and the adjoining territory with unparalleled ferocity. He sacked Porto Bello and did his infernal work at the old city of Panama so effectively that it never was rebuilt. The only thing now standing is an old tower, the ruins of perhaps a mission.

The English likewise had realized the importance of this artificial waterway if it could be constructed and made desperate efforts to gain a firm foothold in Nicaragua. In a few years they practically laid waste to all the civilization in Central America and utterly destroyed its commerce. With one of these dastardly crews came a man named Lionel Wafer who proclaimed that it would be the easiest thing in the world to make the canal. This assertion was used as a basis for an ambitious scheme by the founder of the Bank of England, William Patterson, of Scotland. He attempted to found a colony on the isthmus, but it failed. England and Scotland had not at that time united. It is probable if they had, that a canal would have been dug under English direction

generations ago. After this there was a lapse of a century during which nothing worthy of comment was done.

With the coming of that great scientific genius, Alexander von Humboldt, in the early years of the nineteenth century, a new era in canal schemes dawned. He considered no fewer than nine distinct routes. Practical steps were taken when the South American people themselves felt the quickening influences of the early part of the nineteenth century which were changing the destinies of nations. Under the leadership of Miranda and Bolivar in 1811, the various Central and South American provinces of Spain shook off the frayed strings that bound them, and in 1821 their efforts were completely crowned with success. In 1825, these confederacies invited the United States to participate in the building of a canal. Our government feared to commit itself, being occupied with many troubles of its own and even declined to be specially represented at the first Pan-American Congress which occurred at Panama in 1826. It was believed that the question of human slavery might be considered and resolutions of emancipation might be adopted. As a result of this conference the Congress of the United States of Central America ordered the construction of a canal at Nicaragua, for which a concession eventually passed into the hands of an American company in which participated DeWitt Clinton, builder of the Erie canal, and other very notable men. After this followed numerous schemes, all of which were widely discussed at the time, and are interesting for the additional light they throw on the development of the idea, but which came to naught. One of the curious features of early canal history is that the United States, though palpably most vitally concerned, repeatedly withdrew from some definite contract at the critical moment. Eminent engineers were sent by the government to survey the territory and made favorable reports, but capital

The First Attempt to Sever the Americas

seems to have been frightened off by the savage and unsettled condition of the country. The South Americans themselves even tried to interest the pope at Rome in their scheme. Efforts were made to interest foreign countries and some South Americans even went so far as to ask France to establish a protectorate over the chaotic confederacy so that the canal might be dug. In 1844, the third Napoleon then languishing in jail took such an interest in the scheme that he promised to leave France forever, if the government would release him, in order that he might go to South America. Possibly he might have prosecuted his purpose after his escape if the Revolution had not put him on the throne.

In order to thoroughly understand the subsequent history of the efforts to dig the canal, it is necessary that you understand the circumstances and main features of that contract known as the Clayton-Bulwer treaty. And in order to understand that, you must know some of the very early history of British land-grabbing on the Central and South American continent. You will recall that I spoke of the English freebooters who left a high-water mark for all time in the nameless atrocity of their performances on the isthmus. Later they sailed down at Nicaragua and Honduras and in order to gain the protection of their government became bona fide colonists. They developed an admirable trade in the splendid lumbers that abound and dye woods. In the course of time, England gained a more or less valid title to the territory it had occupied, though the Spanish declined to admit that England was entitled to anything on the mainland.

Early in the seventeenth century there had formed in a locality on the Nicaraguan coast a hybrid race composed largely of Indians known as Moscoes, some English pirates and a strain of negro blood from the refugees of a Dutch slave-ship which was wrecked off the coast. In the course

of time, this race was known as the Mosquito Indians with whom we are more or less familiar in these days. English settlers came to their country and were welcomed; urged by the ties of blood, they begged for the protection of England. In short, for all these various reasons the British government felt that it had a claim on that part of Nicaragua and Honduras originally settled by its sparse groups of pirates, and in 1835 called it "British Honduras," taking advantage of the internecine strife among the members of the Central and South American federation. It also demanded that Mosquitia, as it was then known, should be recognized as a natives' kingdom under British protection. With the seizure of Tigre Island off the Pacific coast, British domination and control of the Nicaragua isthmus was complete. The United States had its own little game to play in the spoilation of Mexico, so that it did not apparently notice the action of the English government to the South. What you must particularly remember is that England controlled the Nicaragua isthmus, one of the future territories for the canal. What scared America was its awakening consciousness that it needed a line of communication across the isthmus of Panama for intercourse with the Pacific coast territories it had wrested from Mexico.

In 1846, our government made a treaty with the republic of New Granada (now known as Colombia) in which it secured the exclusive line of transit across the isthmus of Panama including quite a stretch of country. In return it *undertook to maintain the neutrality of such territory and any lines of traffic that might be established, and guaranteed the sovereignty of the Isthmian territory against any attack by alien powers.* In anticipation of the tremendous traffic which developed after the discovery of gold in California, American capitalists built the Panama railroad which was finished in 1855, operating from Colon

Four Hundred Years of the Panama Canal

(then known as Aspinwall) to Panama, the present capital of the republic of that name. Other Americans attempted to build a canal in the Nicaragua territory and a company, of which Cornelius Vanderbilt was the head, built a transit route across this path, utilizing steamboats on rivers and lakes and coaches and trucks for the remainder of the way. This continued to be a very popular means of travel until the superior facilities of the Panama Railroad utterly destroyed it. Naturally the domination of British sovereignty was regarded as a very menacing situation, and popular indignation in this country was great.

After a twiddling-twaddling period of negotiations in which the envoys of the United States gained laurels, but the home government made a record for pusillanimity, there was concluded one of the most famous and most criticised treaties in our history. Secretary of State John M. Clayton and Sir Henry Bulwer (of the Bulwer-Lytton family) agreed that neither the United States nor Great Britain should exclusively control the Nicaragua canal nor build any fortifications along it; in short, they agreed on absolute neutrality regarding all matters concerning any means of transportation over any route on the isthmus. This would have been very fair except that England insisted this agreement did not apply to any territory it claimed in Central or South America, which made matters a little worse than they were before. In this Clayton acquiesced and the Clayton-Bulwer treaty became the law of the land on July 5, 1850. Then followed many schemes for the building of canals over the various routes, accompanied by much wrangling with England; almost, at various times, precipitating war over interpretations of the Clayton-Bulwer treaty; for obvious reasons the various administrations never had sufficient courage to abrogate this treaty which was so very irksome and obstructive. When Walker the filibuster was at his nefarious work, affairs

in South America became chaotic and England seized the opportunity to arouse prejudice against the United States and to do much intriguing. In the end she gained practically what she wanted, which was an acknowledgment from the South American confederacies concerning the validity of her claim to the entire Mosquito coast.

In 1868 the United States made a treaty with Nicaragua securing the right of way for a canal across that country. This is known as the Dickinson-Ayon Treaty and will recur during the Roosevelt negotiations. There had been much indefinite talk and abortive efforts by American and foreign promoters and capitalists to commence the building of a canal at various places; but finally the true and ultimate American doctrine was enunciated by President Grant: "I commend an American canal, on American soil, to the American people." But after ineffectual attempts to secure an abrogation of the Clayton-Bulwer treaty all American projects were permitted to lapse, and—then came de Lesseps!

An adventurer named Gorgoza secured a concession for a canal over Panama which, in 1876, he took to Paris. He interested the "Old Imperialists" party, including Ferdinand de Lesseps, a nobleman just fresh from his splendid triumph over almost incredible obstacles in the building of the canal at Suez. After the meeting of the International Engineering or Scientific Congress which was called at Paris on May 15, 1879, presided over by de Lesseps himself, it was decided to build a canal in the Panama territory. It has since developed that this "Congress" was nothing but a speculative scheme and was "packed" by the de Lesseps faction for the purpose of giving the project grand *éclat*. The foreigners, invited to attend the conference under the impression that it was called for scientific purposes, left in disgust, and the bankers, pro-

The First Attempt to Sever the Americas

moters and stock-jobbers controlled the meetings. The Universal Inter-oceanic Canal Company was the result, organized and incorporated by de Lesseps. As American apprehension and resentment was aroused by this apparent infringement of the Monroe Doctrine, President Rutherford B. Hayes sent an admirable message to Congress proposing a canal under sole and exclusive American control, no European power to be admitted to even the smallest share. Any money invested by European capitalists must look to the United States alone for protection. De Lesseps tried to induce Colombia to abrogate the treaty of '46 with the United States, but the South American country was informed very emphatically that she would not be permitted to exercise her sovereignty in any way displeasing to this government. Thereupon de Lesseps established an American committee composed of men conspicuous in many important affairs and embarked in a most astounding and preposterously impudent attempt to bribe national legislators, newspapers and every tool that might be of assistance in molding public opinion to a favorable view of the abrogation of our treaty with Colombia. There were also legions of lobbyists at work all over the land to defeat a counter-proposition to build a canal under American dominion by the way of the Nicaragua route.

In 1880, Captain James B. Eads, the great engineer who built the wonderful steel bridge over the Mississippi and the system of jetties at the mouth of the same stream, tried to induce the government to guarantee him financial aid in his scheme to build a ship railroad over the Mexican isthmus known as the Tehuantepec route. It was his purpose, at a cost of \$18,750,000, to build a road by the means of which the largest ship afloat could be loaded upon a monster train of cars at the Atlantic terminal and with its complete cargo

conveyed into the ocean at the Pacific terminal. In a lesser degree this idea has been developed by Sir Weetman Pearson, whose railroad across this route bids fair to be no mean rival to our great canal.

In 1881, de Lesseps began actual work upon his undertaking, the issue of an American canal by American people having been hopelessly befogged by a series of inept attempts by Secretary Blaine and others to abrogate the Clayton-Bulwer treaty. The work was begun with a performance by Sarah Bernhardt in the wretched little Panama theater. While \$60,000,000 subscriptions had been asked for, almost \$121,000,000 were promptly offered. The French people, tens of thousands, no, even perhaps hundreds of thousands, were women who held the stock in small lots. The total amount of money subscribed at various times was \$393,505,100. Consider these figures that follow, which you will find analyzed more thoroughly in my book and you will understand why the French failed to build that canal. The Director-General's palace cost more than \$100,000. His summer house at La Boca cost \$150,000. His salary was \$50,000 a year. And they gave him fifty dollars extra for every day or fraction of a day that he traveled along the line in the sumptuous private car that had been provided at a cost of \$42,000. The stables cost \$600,000; the hospitals at Ancon \$5,600,000 and at Colon \$1,400,000. All these things were needed, truly, but the trouble was that where a \$50,000 building was needed a \$100,000 building was put up and when it was finished the "rake-offs" brought it to \$200,000. In one place I saw where there had been stored thousands of *snow-shovels*—in Panama! In another there were stored 15,000 torches to use in the grand celebration to occur when the canal was finished! It is impossible to cite all the evidences of the extravagant folly of the French. As someone said to

Four Hundred Years of the Panama Canal

me recently: "It was forty-seven miles of graft." Also the Colombians simply plundered the Canal Company right and left; and the company was unfortunate in not having begun in the time when such progress in matters of hygiene had been made as at the present. Their faults were as grave as their misfortunes. They entirely neglected to renovate the isthmus and were content to go on with the unspeakably vile conditions then prevailing.

It is futile in a small way to say more. I have gone into this pretty thoroughly in my book. The consequence of delirious, extravagant folly must be ruin. This is what happened to the French enterprise. The stretch of time between the occasion when Gambetta hailed de Lesseps as "The Grand Frenchman" with the assistance of Victor Hugo and Ernest Renan to the moment when the wretched man sat in the prisoner's dock and heard a sentence of five years' imprisonment pronounced over him, was only nine years. He never served the sentence as he was mentally and physically a wreck. This great man, whose name will live for all time by his achievement at Suez, probably never fully realized what had happened.

After the de Lesseps smash the French company reorganized in order to save what was of value in the wreck. Another concession was obtained from the Colombian government for a substantial consideration. In the meantime, work actually had begun at Greytown on a Nicaraguan canal to be constructed under American auspices. It would possibly have been finished but the financial stringency and the consequent depression of 1893 caused the company to go into the hands of a receiver. The great voyage of the battleship "Oregon" during the Spanish-American War gave an impetus to canal matters in the United States in 1898. It was determined that if this government could prevent it there should never

again be occasion for our battleships to make that long and perilous journey around by the straits of Magellan in order to reach the other side of our coast in the time of need. Therefore, after one fruitless attempt at treaty-making, the old Clayton-Bulwer treaty was finally superseded in 1901 by the second Hay-Pauncefote treaty which practically gives the United States a free-hand over the canal and all the adjacent territory at all times.

Then followed that exciting duel between the United States and the government of Colombia, in the course of which the "graft" government tried to prolong the negotiations by very obvious means so as to nullify its concession to the French company, which expired the next year, 1904. The object, of course, was to get the \$40,000,000 which the United States had agreed to pay the French company for its concession and all the debris on the isthmus. The government of Colombia at Bogota was a pure and simple graft proposition. The men who guided its destinies exploited it for the fattening of their own pocketbooks. Under the terms offered by our government, Colombia was to receive only \$10,000,000 and an annuity of \$100,000 a year after nine years. This was definitely refused by the Colombians after they had made every effort to induce our Commission to select the Panama route. The United States, under the option of the so-called Spooner act which directed the president to build the canal, was about to open negotiations with Nicaragua when the complexion of affairs was changed by the revolution of Panama. It is a mistake to believe that our government fostered and brought about the revolution. It was fostered by the Columbian government and brought about by the Panamans themselves. Until the regimen of the highly dictatorial governments of the last few years, Panama had been a self-respecting state in the Colombian federation. It had, in fact, been the

The First Attempt to Sever the Americas

most prosperous and desirable division of the group. It had the most to gain and the most to lose by the failure of the negotiations with the United States. In political vernacular the government at Bogota was trying to use the free state of Panama to make money for what we could call the Ring. Panama remonstrated without avail.

The revolution was organized, and with the assistance of Bunau-Varrilla, a wealthy French engineer, was consummated. The manner of its development is highly interesting. You will find the exact facts concerning the so-called interference of Mr. Roosevelt in my book. There was absolutely no interference. In 1903 the Hay-Bunau-Varilla treaty was consummated. For the sum originally offered to the government of Colombia, Panama gave to the United States in perpetuity the use, occupation and control of a strip ten miles wide and extending three nautical miles into the sea at either terminus. The United States assumes the sanitation of the cities of Panama and Colon and the maintenance of order if need be.

The Republic of Panama has now been recognized by all the nations of the earth. It is about the same size as the state of Maine. It has a splendid administration, a really fine constitution and is a beautiful country. The stuff that you may have read about its swampy jungles and its malarious condition is generally the result either of malice or misinformation. It is not affected by earthquakes, has an average temperature of seventy-nine degrees Fahrenheit and never goes to 100 degrees Fah-

renheit, which is common in New York and other parts of the Temperate zone. The humidity is very great. The winds of course are steady, being in the range of the trade current, and the rainfall is heavy in season. October is the rainiest month. Panama is the capital city. To me it is by far more cosmopolitan than any city except, perhaps, two we have in the United States—and I don't include New York among the two. I am sorry I can't tell you more about the city and the people and the country. It is all exceedingly worth while. The canal itself is being dug through a route on which at no point the mountains are three hundred feet above sea level. This mountain is where the famous Culebra cut is being scooped out. This is the crux of the work. The earth taken out here is conveyed to Colon which needs building up and is being used to elevate that city. After the various confusing episodes that have occurred since we have undertaken the canal, I think we are getting along splendidly. The matter of sea-level and lock canal has not been definitely settled for all time and many authorities think that we will have to adopt the sea-level because of the geological constitution of the soil. You know there is no rocky mountain where we are building the canal. The hills are practically nothing but a friable earth. The so-called backbone of North and South America does not extend across the isthmus. The rock in the soil at the cut at Culebra has been found at a depth of two hundred and fifty feet. This is the plain record of the principal facts regarding the construction of the Panama Canal.

“God to the human soul,
And all the spheres that roll
Wrapped by her spirit in their robes of light,
Hath said: ‘The primal plan
Of all the world and man
Is Forward! Progress is your law, your right!’”

Struggle for Control of America

Ambition of
the European Powers
to Add the Western Continent to
Their Empires & America's Fate in the Balance
During the Great Battles on the Spanish Main & Baring
Adventures of the Great Admirals of the Caribbean Sea & Researches

BY

FRANCIS RUSSELL HART, F. R. G. S.

MEMBER OF MANY LEARNED AMERICAN SOCIETIES AND FELLOW OF THE ROYAL GEOGRAPHICAL SOCIETY
OF GREAT BRITAIN—COPYRIGHT ASSIGNED TO THE AUTHOR

Ere men the virtue of the magnet found,
The ocean scarcely heard a human sound,
For western suns were deemed to shine in
vain,
Or only light the monsters of the main.
The seas were narrow which the boldest
crossed,
And numbers trembled if the shore were
lost.
Now a far world incites the liquid race,
And oceans vast our intercourse increase.
The use we know, but haply ne'er shall find
Whence to the pole the magnet is inclined;
How a dark, heavy stone the earth supplies,

Maintains a correspondence with the skies;
How it imparts to steel the art it knows,
Yet keeps entire the virtue it bestows:
Long may the needle feel the art divine,
To show the pathless way and wat'ry line;
Pointing the steersman straight o'er con-
vex seas,
Whose mere extent were else a clueless
maze;
For, foam the ship tow'rds tropic, line or
pole,
The compass seems her brain, tho' art's her
soul.

—J. KIRKPATRICK IN 1750.

THE great story of the Car-
ibbean Sea has as yet
been only half written.
The story of discovery,
of conquest, of struggle
over the keeping,—a
story in which kings be-
came pirates and in which pirates be-
came almost kings, and in which the
destinies of the countries of the Old
World became singularly entwined
with the destinies of those of the New.
The motive of the struggles was gold,
not lands nor men.

The country of the North had later
its wars of conquest and of settlement,
but the plunder was land and great
rivers and not the storehouses of other
men. In a fragmentary way this
great romantic story has been written,
partly in the books of students of
history and part remaining in the
archives of the descendants of the
conquistadores. Some day the great
historian must come who will do for
the waters and shores of the great
Caribbean what Prescott and Park-
man have done for the North. The

preparation of these few monographs
has been due to a desire on the part of
the author to put in convenient form
for the future historian the story of
certain great battles and events in a
part of the Spanish Main with which
the author through several years' resi-
dence is most familiar.

For the most part the original rec-
ords and reports of those engaged in
the expeditions have been the sources
of information, the stories of both the
attacked and attacker being carefully
compared and each interpreted with
proper regard to local, physical and
other conditions personally observed
by the author.

By themselves these accounts
show a few characteristic events out
of the three centuries of struggles
during which Spain both reached and
fell from the zenith of her power in
both the Old and New Worlds.

This first monograph, with its rare
prints, tells the fascinating story of
that great admiral, Drake, and his ad-
ventures on the Spanish Main from
1567 to 1596.

The Great Story of the Caribbean Sea

DURING the last quarter of the sixteenth century Spain was the strongest of European powers, and Philip the most powerful of monarchs. In the New World, Spanish rule was absolute from Florida to the Rio de la Plata on the Atlantic coast, and from the Isthmus south on the Western coast of South America; in fact, a papal grant had conveyed the whole of America to the Spanish Crown. A small French settlement on the St. Lawrence in the North, and an expedition to Labrador by Frobisher, under the patronage of Queen Elizabeth, showed that the somewhat arrogant claim of Spain to the whole of America was not uncontested.

Protestant England under Elizabeth longed not only for a share of the rich plunder which the exploitation of the New World was gaining for Spain, but also for an opportunity to cross swords with Catholicism. On both sides the adventurous spirit was strangely mixed with religious enthusiasm. Prayers and piracy were closely, and often with sincerity, blended. The fact that no commerce except with Spain was permitted in the New World made trade by English ships and men possible only when carried on by privateers or armed vessels. The inevitable result of these conditions was that English ships ostensibly fitted for trade turned to plundering the rich galleons of Spain, giving rise to reprisals with terrible excesses on both sides.

The story of the great seamen of Elizabeth's reign — Drake, Hawkins and Frobisher, is almost the history of the England of their day; a story replete with the romance of dangerous adventure, reckless courage, cruelty and craft, but none the less the story of brave and gallant men who fought battles not only for their own but for succeeding generations.

Upon Drake's return from his great voyage around the world, begun in 1577 and ended in 1580, he was re-

ceived with great enthusiasm by both queen and country. On this voyage he had sacked the unguarded coast towns of Peru and Chili, and it is said returned with over half a million sterling of treasure taken chiefly from the Spanish possessions. That Drake himself was knighted and his company feted by all England, was not unnaturally received as an insult by Philip, and added fuel to the flames of war already kindled. There could be now no further question of conciliating Spain, and every effort was made by Elizabeth and her sailor counsellors to build up a naval establishment of a strength equal to that of Philip, his naval power having been almost doubled through the acquisition of Portugal by the failure of its royal line. To make havoc with the Spanish possessions in the New World appealed to both the political sagacity of the queen and to the business-like judgment of those imbued with the buccaneer spirit of the age.

It has been necessary to touch thus briefly on the general conditions affecting England and Spain at the time of the expedition against Cartagena and other towns of the Spanish Main, in order to more justly conceive the true value and motives of an attack which has been variously described as a great legitimate naval expedition and as a series of wanton piratical seizures. To more adequately gain a proper perspective it will be necessary to also touch briefly on the earlier history of Drake.

Few men whose deeds have played such an important and forceful part in actual events, have had associated with their names so much of almost legendary romanticism as has that of Francis Drake. Knighted and made an admiral by Elizabeth, and dubbed a pirate by the Spaniards, he was in truth a mixture of the great soldier-admiral and the adventurous buccaneer. His father, Edmund Drake, is said to have been at one time a sailor, but be this as it may, he had become vicar of Upchurch, living near Tavis-

The Great Story of the Caribbean Sea

tock, under the patronage of the Earl of Bedford. It was the earl's son, Francis Russell, who endowed the son born to Edmund Drake with his own name.

Francis Drake was born about 1545. His early associations were strongly anti-Catholic. As a boy he was apprenticed to the master and owner of a small channel coasting vessel, and appears to have been treated as a son by the master, who upon his death not very long after left the vessel to him.

Sir John Hawkins, said by some to have been a kinsman of Drake, had been early engaged in the slave-trade and in trading expeditions to the West Indies and Spanish Main. In 1567 he visited the Spanish Main, and only succeeded in landing and selling his negroes at Rio de la Hacha after overcoming armed resistance. He finally at Cartagena abandoned this commerce. This voyage was in many respects unfortunate, and it was also alleged that many acts of bad faith on the part of the Spaniards brought great hardships, sufferings and death to many of Hawkins' unhappy companions. Hawkins himself says in his account of the expedition: "If all the miseries and troublesome affairs of this sorrowful voyage should be perfectly and thoroughly written, there should need a painful man with his pen, and as great a time as he had that wrote the lives and deaths of the martyrs."

Great indignation was felt in England over the mishaps of this voyage and the treatment of the voyagers by the Spaniards. Drake had taken part in this expedition in command of the "Judith," having previously sold his own little coaster and used the proceeds, with his other earnings, for the proper outfitting for this voyage with Hawkins. Having lost everything in this unhappy venture, from which he barely escaped with his life, Drake became an ardent supporter of the doctrine, soon popular in England, that it was lawful to recover from the Spaniards that which their treachery

had taken from the English traders.

In 1570 Drake again went to the West Indies, this time with two ships, the "Dragon" and the "Swan," and again in 1571 with the "Swan" alone. These voyages appear to have been mainly for acquiring information, or at least, that appears to have been their chief result. With the experience gained by these two voyages and the previous one with Hawkins, he sailed from Plymouth in May, 1572, with the "Pacha" of seventy tons, and "Swan" of twenty-five tons, with total crews of seventy-three men and boys. By the end of July he reached Nombre de Dios, and after a sharp but brief engagement, in which he himself was wounded, captured the town. From Nombre de Dios he sailed along the coast towards Cartagena, capturing several well-laden vessels on the way, but making no stop of consequence until arriving at the Isthmus of Darien. There he found settlements of the Cimarrones (or Maroons), negroes who had escaped from slavery, with whom he entered into intercourse and by the chief of whom he was shown from a "goodly and great high tree" on a commanding height a sight of the Pacific ocean. Drake is reported to have "besought Almighty God of his goodness to give him life and leave to sail in an English ship on that sea." This same chief guided and helped in an expedition overland to intercept the trains of mules which brought treasure from Panama to Nombre de Dios. Beyond taking possession of a small town on the road and destroying some property the expedition appears to have been fruitless, and it was only after great hardships and dangers that Drake and his men regained their ships. He returned to Plymouth from this voyage on August 9, 1573, somewhat enriched, but with his ambition in no way satisfied. A valorous and venturesome seaman named John Oxenham, whose name is closely associated with the stirring events of that day in the Caribbean littoral, had served under Drake

The Struggle for the Control of America

in this expedition. About two years later Oxenham, with one ship and seventy men, retraced the course of Drake to Darien with the object of intercepting one of the richly laden mule trains from Panama. Being informed by the Cimarrones that the trains were now accompanied by a strong guard, he abandoned this plan and, helped by a few of the Cimarrones, marched to the Pacific side, built himself a small pinnace, and gained the distinction of being the first Englishman to sail upon the Pacific ocean. In December, 1577, Drake started on his great trip of circumnavigation, already referred to, with a fleet consisting of the "Pelican" and four smaller vessels, having a total complement of one hundred and sixty-four men. That the plans for this voyage had the full, if secret, concurrence of the queen there seems little doubt, notwithstanding the fact that one of its real if not avowed objects was to prey upon the colonies of a nation with which technical peace existed. The story of this voyage has no place here, but its great success from both a naval and "profit-sharing" standpoint, and the enthusiasm with which the voyagers were received on their return in September, 1580, "richly fraught with gold, silver, silk, pearls and precious stones," added greatly to the prestige of Drake.

For the next four years Drake remained in England, becoming mayor of Plymouth for a brief period and then entering Parliament as member for Bossiney.

Early in 1585, Elizabeth could no longer blind herself to the certainty of the intention of Spain to attack England. A fleet of English ships laden with corn had been unfairly seized, and swift retribution was planned. Under letters of marque Drake gathered about him at Plymouth the most formidable squadron of privateers ever gotten together, consisting of twenty-five ships with a total of twenty-three hundred sailors and soldiers. His vice-admiral was the doughty Martin Frobisher; his

rear-admiral, Francis Knollys, and Lieutenant-General Christopher Carleill was in command of the ten companies of land troops included in the complement.

The fleet sailed from Plymouth on the twelfth of September, 1585. After threatening Bayona and Vigo, and by his promptness and courage doing much to injure the morale of the Spanish naval defences, Drake proceeded to the Cape de Verde Islands, taking almost unopposed possession of the chief town, Santiago, and plundering the islands for provisions and anything of value. From there he began his voyage towards the West Indies with the greatest armament which had ever crossed the Atlantic. His plan was to weaken Spain by cutting off the chief sources of her wealth in the New World and to strengthen England by obtaining the mastery of the rich Caribbean ports from which it seemed a limitless stream of gold could be made to flow into the Old World.

During the voyage to the West Indies the men suffered severe losses from deaths due to an infectious sickness, and the squadron arrived somewhat weakened in consequence at the Island of Dominica. This island is described by Thomas Cates, one of the company officers who wrote a complete account in Hakluyt's Voyages, as inhabited by "savage people, which goe all naked, their skinn coloured with some painting of a reddish tawny, very personable and handsome strong men." From thence the squadron proceeded towards Hispaniola (San Domingo), spending Christmas (1585) at anchor at the Island of St. Christopher (St. Kitts) where no people were found.

The city of San Domingo in Hispaniola was one of the chief strongholds of the Spaniards in the West Indies, and so strongly built and fortified that no serious attack had previously been attempted upon it. It was surrounded by walls and batteries of some strength and reputed to be gar-

The Great Story of the Caribbean Sea

Extract from account published by M. Thomas Cates (V. Hakluyt's Voyages), entitled:
"A SUMMARIE AND TRUE DISCOURSE OF SIR FRANCIS DRAKE'S
WEST INDIAN VOYAGE, BEGUN IN THE YEERE 1585."

This worthy knight for the service of his Prince and countrey having prepared his whole flecte, and gotten them down to Plimmouth in Devonshire, to the number of five and twenty saile of ships and pinnesses, and having assembled of souldiers and mariners, to the number of 2300 in the whole, embarked them and himselfe at Plimmouth aforesaid, the 12 day of September 1585, being accompanied with these men of name and charge, which hereafter follow:

Master Christopher Carleil Lieutenant General, a man of long experience in the warres as well by sea as land, who had formerly carried high offices in both kindes in many fights, which he discharged alwaies very happily, and with great good reputation.

Anthonie Powel Sergeant Major.

Captaine Matthew Morgan, and Captaine John Sampson, Corporals of the field.

These officers had commandement over the rest of the land-Captaines, whose names hereafter follow:

Captaine Anthony Plat,

Captaine Edward Winter,

Captaine John Goring,

Captaine Robert Pew,

Captaine George Barton,

Captaine John Merchant,

Captaine William Cecill,

Captaine Walter Bigs,

Captaine John Hannam,

Captaine Richard Stanton.

Captaine Martine Frobisher Viceadmirall, a man of great experience in sea-faring actions, who had carried the chiefe charge of many ships himselfe, in sundry voyages before, being now shipped in the Primrose.

Captaine Francis Knolles, Reereadmirall in the Galeon Leicester.

Master Thomas Vennor, Captaine in the Elizabeth Bonadventure under the Generall.

Master Edward Winter, Captaine in the Aide.

Master Christopher Carleil the Lieutenant generall, Captaine of the Tygar.

Henry White, Captaine of the sea Dragon.

Thomas Drake, Captaine of the Thomas.

Thomas Seelie, Captaine of the Minion.

Baily, Captaine of the Barke Talbot.

Robert Crosse, Captaine of the Bark Bond.

George Fortescue, Captaine of the Barke Bonner.

Edward Carelesse, Captaine of the Hope.

James Erizo, Captaine of the White Lyon.

Thomas Moone, Captaine of the Vantage.

John Vaughan, Captaine of the Drake.

John Varney, Captaine of the George.

John Martin, Captaine of the Benjamin.

Edward Gilman, Captaine of the Skout.

Richard Hawkins, Captaine of the Galiot called the Ducke.

Bitfield, Captaine of the Swallow.

risoned by a powerful force, although the Spanish accounts state that about 2,000 only of the 8,000 inhabitants were capable only of bearing arms and that in the actual defense of the city a few hundred only participated. Cates refers to the "glorious fame of the citie of S. Domingo, being the ancientest and chiefe inhabited place in all the tract of country thereabouts."

The squadron arrived at a safe landing-place about ten miles from the city, on New Year's day, 1586, and notwithstanding the commotion created in the city by the approach of the large flotilla,

the troops were secretly landed without molestation under cover of the night. In the morning following, Drake made a feint at landing on the opposite side towards which Carleill with the men already landed was approaching. The advantage gained by this manœuvre was pushed home, and after a short engagement in the streets and market-place the victory was won.

The town being rather large for complete occupancy by the small number of troops under Carleill, he was directed by Drake to intrench himself in the most important part of the town, the Spanish troops being then divided



S^r FRANCIS DRAKE.

This Picture was taken from an Original Painting. Communicated by the Hon^{ble} S^r Phillip Sydenham Bar^t Kn^t of y^e Shire for Somerset.

The Struggle for the Control of America

into two divisions, one which had fled to safety well outside of the city, and the other remaining in that part not invested by the English forces.

Drake now demanded a large ransom for the release of the town. During the negotiations he sent a negro boy with a flag of truce to the Spanish camp; the boy being met by a few Spanish officers was so wounded by one of them that he could barely crawl back within his own lines to die. This so inflamed the natural anger of Drake that in the first burst of his fury he had hanged, on the spot of the boy's death, two friars who were among the prisoners, and declared that until the cowardly Spaniard who killed the boy was publicly executed two more prisoners would be hanged daily. This demand was quickly met. The amount of the ransom which the city, even with difficulty, could pay, was not so great as Drake had expected, and he had to be contented with twenty-five thousand ducats, probably equivalent to about sixty thousand dollars of American money. In addition, all valuable property of a shape to permit of removal was taken aboard the ships, including from two to three hundred guns and ample stores of provisions. A few of the better vessels in the harbor were taken and the remainder destroyed.

Exhilarated by victory, and with his squadron in reinforced condition, Drake sailed the middle of February for Cartagena on the Spanish Main. It was now that the experience which he had gained in his earlier voyages stood him in good stead, for he could approach this difficult shore and harbor with the confidence of an experienced pilot.

The town of Cartagena had been founded a little more than fifty years before Drake's attack, and was already well fortified, although its system of walls and fortifications which were afterwards intended to make it impregnable, were not then wholly completed. The town is situated at

the eastern extremity of the harbor or Bay of Cartagena, on low level land. While its southwestern side faces the harbor, its northwestern face is actually on the open sea itself and the surf breaks near the base of strong walls on that side. The remaining boundary is largely made up of a great shallow lagoon almost connecting with the sea on the one side, and connecting with the harbor on the other. The harbor itself is made nearly a closed basin by the Island of Tierra Bomba, at each end of which in Drake's time was an entrance for ships, the larger called Boca Grande being nearer the city, and the smaller and more difficult called Boca Chica being near the western end of the bay.

The Boca Grande entrance was subsequently closed by artificial means, which, when once effected, was greatly helped by the natural drift of the sands. It has now been closed for all but the smallest boats for over two centuries.

Cartagena, by reason of its magnificent harbor and its nearness to the great river Magdalena, which led down from the rich country in the interior, had become the storehouse of Spain in the New World, and the headquarters of all Spanish commerce. Relying upon the reputation of Cartagena for strength to keep itself from being attacked and having no conception that such an audacious attack upon his American possessions would be made, Philip had not had time to send out in advance of Drake's arrival any reinforcements. So that, although warned in advance of the impending visit of Drake with his formidable squadron, the governor of Cartagena, Pedro Vique, could not depend on more than eleven or twelve hundred men all told for the defence of his city. This force was made up of fifty lancers, four hundred and fifty harquebussiers, one hundred pikemen, twenty negro musketeers, four hundred India bowmen and one hundred and fifty harquebussiers who manned two galleys in the harbor.

The Great Story of the Caribbean Sea

The entrance to the inner harbor was defended by a fort at the place now called Pastelillo, but otherwise there were no fortifications except those surrounding the city itself. The approach to the inner harbor was further protected by chains, and the narrow neck of land reaching from the city to Boca Grande was defended by a stone breastwork armed with a few guns and several hundred men.

Drake entered through Boca Grande between three and four in the afternoon without resistance. At nightfall he landed the troops under the command of Carleill close to Boca Grande. About midnight, having failed to find paths through the thick growth which covered the neck of land, they marched along the beach on the side towards the sea, meeting only the slight resistance offered by a small body of horsemen who retired at the first volley.

The sound of this slight engagement was a signal to Drake to order the carrying out of a pre-arranged plan, by which the ships attacked the fort at the entrance to the inner harbor. This attack was a diversion and was not pressed to a successful conclusion, as indeed would have been difficult in view of the narrowness of channel, the chains, and the well-sustained gun fire from the fort.

During this attack by the ships the troops pressed forward against the breastworks, which consisted of a well-built stone wall with a ditch without and flankings covering every part. A small passing space was protected by wine-butts filled with earth, the whole mounted with six guns and further protected by drawing into the harbor shore the two large galleys.

Carleill forced the attack on the space protected by the wine-butts, and largely through the superiority of the English pikes and armour a breach was made and quickly carried by storm. The defenders were forced into the city, where the streets were strongly barricaded. The Indians rendered active help to the Spaniards,

fighting with poisoned arrows and with small sharp poisoned sticks about eighteen inches long, and so placed in the ground that contact with the poisoned ends was difficult to avoid. Many of the Spanish leaders were killed and Drake was soon in possession of the city. While Drake's idea had been to permanently hold Cartagena and use it for a base from which to attack the other Spanish settlements, the reduction which he had already suffered in his forces and the persistence of yellow fever among his men, changed his plans and he determined to exact the largest possible ransom and leave the place. At a general council of land captains held at Cartagena on the twenty-seventh of February, it was resolved that it was inexpedient to proceed with the intended capture of Panama and it was resolved to proceed home by the way of Florida.

Drake demanded a ransom of £100,000, but this sum was declared by the Spaniards impossible to be gotten together and paid, and an amount equivalent to about £28,000 was tendered. In the meantime, notwithstanding various courtesies exchanged between the higher officers on each side, much irritation appears to have arisen over the matter of the ransom, and a considerable part of the city was burned. Finally a ransom stated by Cates to have been 110,000 ducats, and by Spanish authorities to have been \$400,000, was paid and the English troops evacuated. Drake, however, after leaving the city, insisted that an abbey or priory just outside had not been included in the terms of settlement, and continued to hold it until an additional sum of 1,000 crowns was paid.

Altogether the fleet had remained at Cartagena six weeks when it finally set sail the last of March, and was even then delayed by leaky vessels and did not arrive off Cape Anthony on the eastern end of Cuba until the twenty-seventh of April. Here the fleet took water and proceeded to the

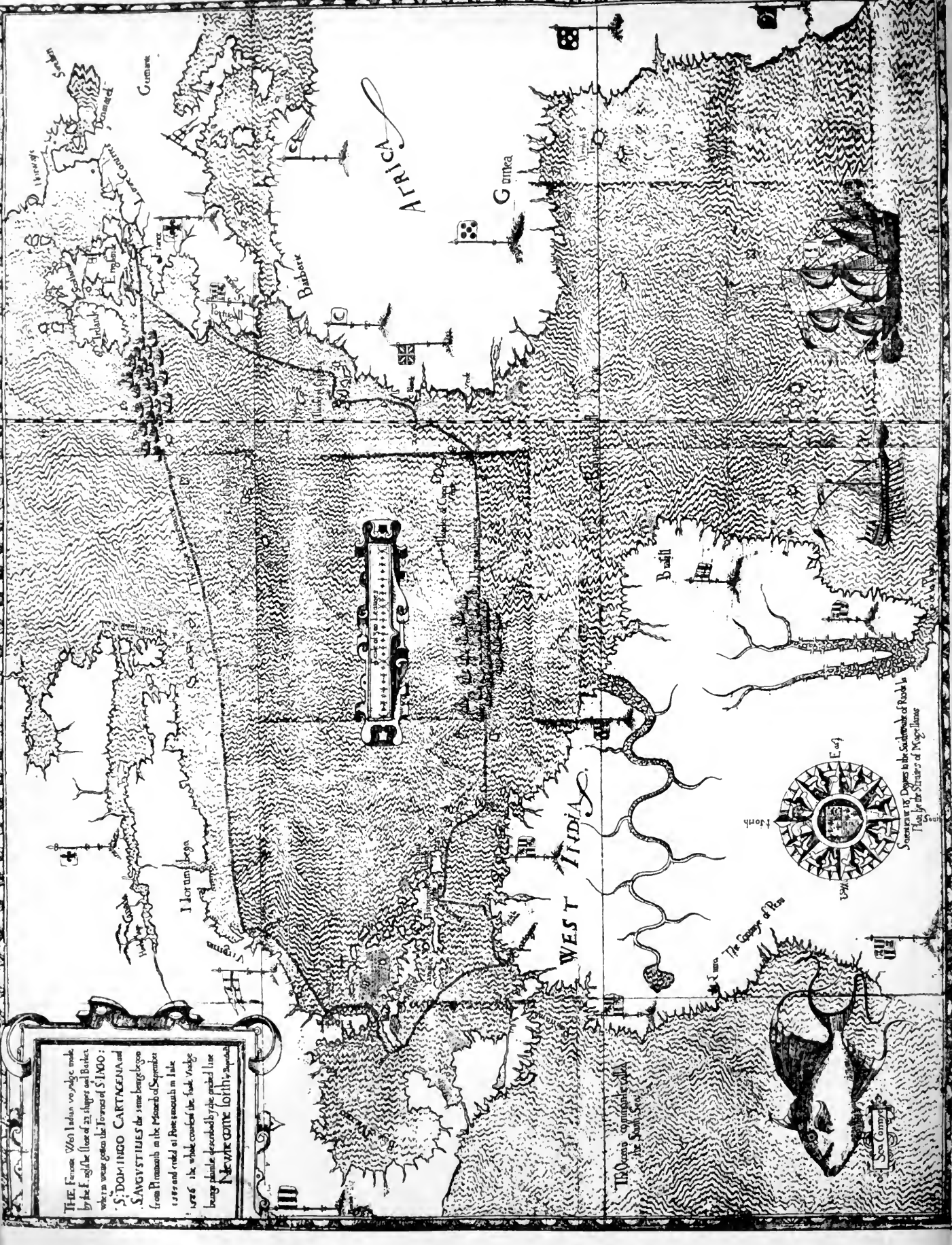

THE FRENCH *Wen* Indian voyage made by the East India Company and Barten, who was upon the *Torrey* of SIMON: S. DOMINGO CARTAGENA and S. ANTOINIALES de some longer began from Port-au-Prince in the Month of September 1705 and ended at Port-au-Prince in June 1706 the whole consisted the *Ship* *Voyage* being *planned* described by the printed line *Now* we come to the *Map*

THE *Ocean* *copied* *in* *the* *South* *Sea*

Sea *Coast*

Some are six Degrees to the Southward of Barbadoes
This is the Situation of *St. Vincent*

BRITAIN

WEST INDIES

AFRICA

Gambia



The *Coast* of *Peru*



Sea *Coast*

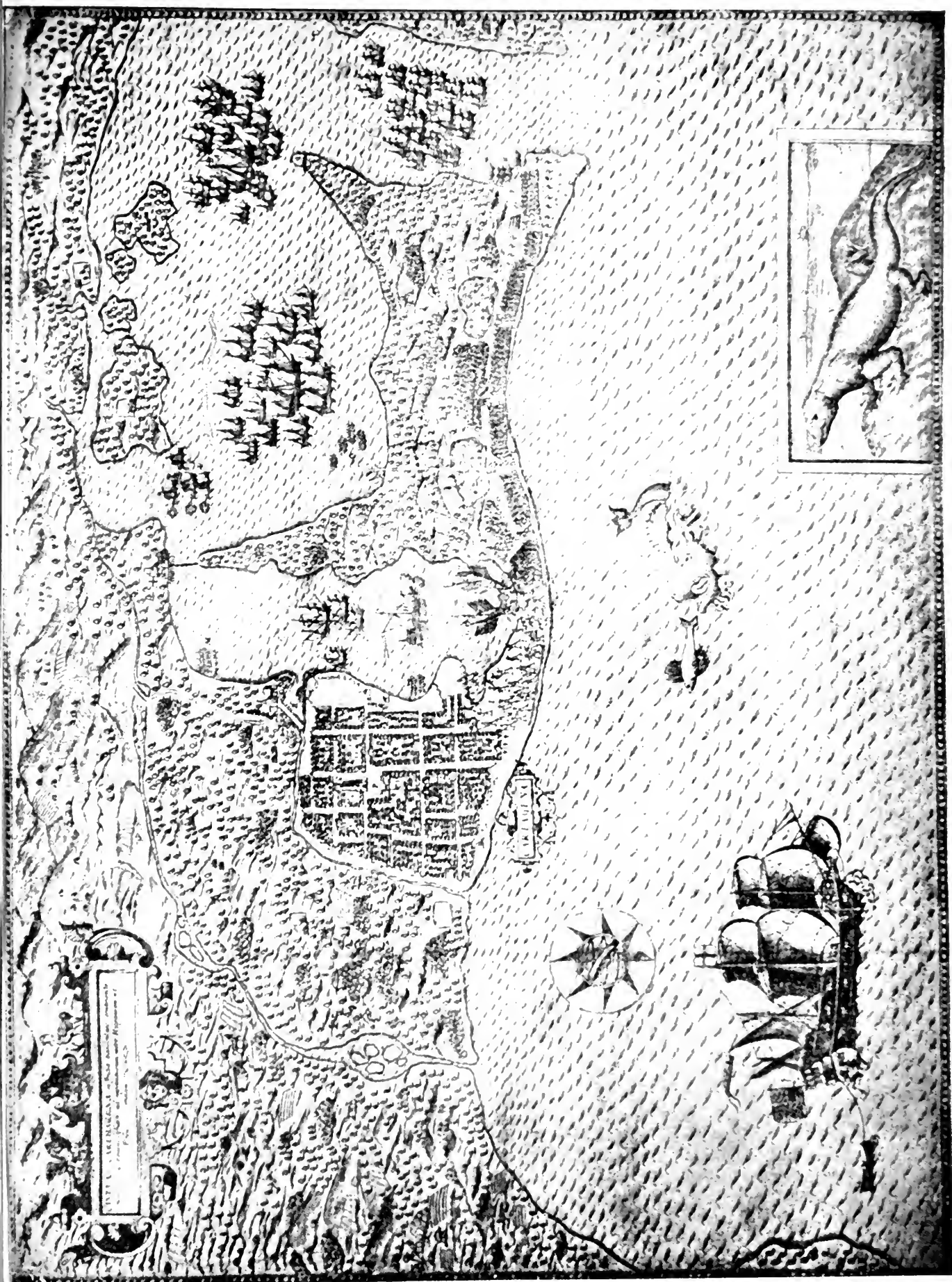

DRAKE'S ATTACK ON CARTAGENA IN THE NEW WORLD. Rare reproduction from a contemporary map in the Congressional Library at Washington for The Journal of American History

The Struggle for the Control of America

coast of Florida, where St. Augustine and various smaller and less important places were captured. The fleet then sailed for Plymouth and arrived there the twenty-eighth of July, 1586.

There were on this voyage a total of seven hundred and fifty men lost from all causes, the greater number being from disease.

The total value of the booty gained was about £60,000, not counting some two hundred and forty pieces of ordnance, of which about two hundred pieces were of brass, including sixty-three from Cartagena.

Drake had ably and bravely executed the task which had been given him and returned home with increased popularity and prestige. The actual injury to the king of Spain by the expedition was less than the harm done to individuals in the Spanish possessions, a fact which served to create a hatred of the English which survived for generations.

In the following year, 1587, when an invasion of England was again feared by Elizabeth, Drake was ap-

pointed to command the English fleet which was immediately formed to prevent the "joining together of the king of Spain's fleet out of their several ports." He attacked Cadiz, where he destroyed thirty-three vessels and carried away others. After several other captures he returned to England, to be sent out again in July, 1588, as vice-admiral, under Lord Howard, of the fleet sent to intercept the "Spanish Armada," the history of which is too well-known to need repetition here. The next year Drake was in command of an expedition to invade Spain and Portugal. After his return from this service he again served in Parliament, but the sea once more claimed him in August, 1595, when he sailed, on what was to be his last voyage, for the West Indies with Sir John Hawkins as his vice-admiral. Hawkins died off Puerto Rico in November, and on the twenty-eighth of January, 1596, Drake himself died on board of his ship when off Nombre de Dios after a fortnight's illness in his cabin.

"TRYALL OF OUR FORTUNE" IN AMERICA IN 1585

Accurate Transcript from "a resolution of the Land-captaines, what course they think most expedient to bee taken. Given at Cartagena the xxvij. of Februarie, 1585"

Whereas it hath pleased the Generall to demaund the opinions of his Captaines what course they thinke most expedient to be now undertaken, the Land-captaines being assembled by themselves together, and having advised hereupon, doe in three points deliver the same.

The first, touching the keeping of the towne against the force of the enemy, either that which is present, or that which may come out of Spaine, is answered thus:

We holder opinion, that which this troope of men which we have presently with us in land-service, being victualled and munitioned, wee may well keepe the towne, albeit that of men able to answere present service, we have not above 700. The residue being some 150 men by reason of their hurts and sicknesse are altogether unable to stand us in anystead; wherefore hereupon the Sea-captaines are likewise to give their resolution, how they will undertake the safetie and service of the Shippes upon the arrivall of any Spanish Fleete.

The second poynt we make to be this, whether it bee meete to goe presently homeward, or els to continue further tryall of our fortune in undertaking such like enterprises as we have done already, and thereby to seeke after that bountifull masse of treasure for recompence of our travailes, which was generally expected at our comming forth of England: wherein we answere:

That it is well known how both we and the souldiers are entred into this action as voluntarie men, without any imprest or gage from her Majestie or any body els, and forasmuch as we have hitherto discharged the parts of honest men, so that now

The Great Story of the Caribbean Sea

by the great blessing and favour of our good God there have bin taken three such notable townes, wherein by the estimation of all men would have been found some very great treasures, knowing that S. Iago was the chiefe citie of all the Islands and traffiques thereabouts, S. Domingo the chiefe citie of Hispaniola, and the head government not only of that Iland, but also of Cuba, and of all the Hands about it, as also of such inhabitations of the firme land, as were next unto it, & a place that is both magnificently builded, and interteineth great trades of merchandise; and now lastly the citie of Cartagena, which cannot be denied to be one of the chiefe places of most especiall importance to the Spaniard of all the cities which be on this side of the West India; we doe therefore consider, that since all these cities, with their goods and prisoners taken in them, and the ransoms of the said cities being all put together, are found farre short to satisfie that expectation which by the generality of the enterprisers was first conceived: And being further advised of the slendernesse of our strengthe, wheremto we be now reduced, as well in respect of the small number of able bodies, as also not a little in regard of the slacke disposition of the greater part of those which remaine, very many of the better mindes and men being either consumed by death, or weakened ly sicknes and hurts; And lastly, since that as yet there is not laid downe to our knowledge any such enterprise as may seeme convenient to be undertaken with such few as we are presently able to make, and withall of such certaine likelihood, as with Gods good successe which it may please him to bestow upon us, the same may promise to yeeld us any sufficient contentment: We doe therefore conclude hereupon, that it is better to hold sure as we may the honour already gotten, and with the same to returne towards our gracious Sovereigne and Countrey, from whencee if it shall please her Majestie to set us forth againe with her orderly meanes and intertainment, we are most ready and willing to goe through with anything that the uttermost of our strength and indeavour shall be able to reach unto; but therewithal we doe advise, and protest that it is farre from our thoughts, either to refuse, or so much as to seeme to be wearie of any thing, which for the present shalbe further required or directed to be done by us from our Generall.

The third and last poynt is concerning the ransome of this citie of Cartagena, for the which, before it was touched with any fire, there was made an offer of some xxviij. thousand pounds sterling.

Thus much we utter herein as our opinions agreeing (so it be done in good sort) to accept this offer aforesayde, rather then to break off by standing still upon our demands of one hundred thousand poundes, which seemes a matter impossible to be performed for the present by them, and to say trueth, wee may now with much honour and reputation better be satisfied with that summe offered by them at the first (if they will now bee contented to give it) then we might at that time with a great deale more, inasmuch as we have taken our full pleasure both in the uttermost sacking and spoyling of all their householde goods and merchandize, as also in that we have consumed and ruined a great part of their Towne with fire. And thus much further is considered herein by us, that as there bee in the Voyage a great many poore men, who have willingly adventured their lives and travailes, and divers amongst them having spent their apparell and such other little provisions as their small meanes might have given them leave to prepare, which being done upon such good and allowable intention as this action hath alwayes caried with it, meaning, against the Spanyard our greatest and most dangerous enemy: so surely we cannot but have an inward regardes so farre as may lye in us, to helpe either in all good sort towards the satisfaction of this their expectation, and by procuring them some little benefite to encourage them and to nourish this readie and willing disposition of theirs both in them and in others by their example against any other time of like occasion. But because it may bee supposed that herein wee forgette not the private benefite of our selves, and are thereby the rather mooved to incline our selves to this composition, wee doe therefore thinke good for the clearing of ourselves of all such suspition, to declare heereby, that what part or portion soever it bee of this ransome or composition for Cartagena, which should come unto us, wee doe freely give and bestowe the same wholly upon the poore men, who have remayned with us in the Voyage, meaning as well the Saylor as the Souldier, wishing with all our hearts it were such or so much as might seeme a sufficient rewarde for their painefull indeavour. And for the firme confirmation thereof, we have thought mete to subscribe these presents with our owne hands in the place and time aforesayd.

Captaine Christopher Carleill Lieutenant Generall.
Captaine Goring.
Captaine Sampson, Captaine Powell &c.



AN EARLY AMERICAN FINANCIER

General Robert Patterson of Philadelphia—Born in 1792—He was prominent in the Development of the Sugar Industry of Louisiana and the Cotton Mills of the South--An Organizer of Railroad Communication with Baltimore, a Financier of the Pennsylvania Railroad, and Steamship Transportation with the Southern ports and Europe

Portrait in Possession of His Grand Daughter

Observations of an Early American Capitalist—"He was Born a King"

Diary of

General Robert Patterson *

Born in 1792 * An Intimate Friend of

All the Presidents from Jefferson to Garfield, and

One of the Greatest Merchant Magnates of His Generation *

Eminent Americans and Europeans Gathered at His Mansion in Philadelphia

ORIGINAL DIARY IN POSSESSION OF

MRS. LINDSAY PATTERSON

WINSTON-SALEM, NORTH CAROLINA

GRAND DAUGHTER OF GENERAL ROBERT PATTERSON

THIS manuscript is from a diary kept by General Robert Patterson of Philadelphia when on a journey in 1835 from that town to the upper Mississippi. In two volumes

he described minutely the people, customs, towns, hotels, crops, politics, and more especially, the early history of each section visited. Written in his illegible chirography, it was copied by his son, the late Colonel William Houston Patterson, who added many explanatory notes, as at the age of eleven he was taken by his father over the same route. After Colonel Patterson's death, the diary came into the possession of his daughter, Mrs. Lindsay Patterson of North Carolina.

General Patterson's route lay through Virginia, following the old Wilderness Road through East Tennessee into Kentucky, down the Ohio and up the Mississippi, through Iowa, thence returning by the Great Lakes, New York State, Hudson river, and home again. He traveled by "rail-car," stage, canal-boat, steam-boat and horseback.

General Patterson was a man of whom his contemporaries spoke in terms of greatest praise.

The statesman, John Sherman, in speaking of him, once remarked: "He

was a born king and the only man I ever knew who would have graced any throne in Europe."

General Winfield Scott Hancock said: "Having served through three wars, that of 1812, the Mexican and Civil War, General Paterson has had a wider experience with men and events than usually falls to the life of one man, for in his time he has been a successful planter, merchant and manufacturer on grand scales, as well as a distinguished soldier. Even at this day, in his eighty-eighth year, he controls the details of great manufactories, employing five thousand operators."

General Joseph Eggleston Johnston, the Confederate warrior, once exclaimed: "For thirty years I have admired General Patterson as a soldier, patriot and gentleman."

General William Tecumseh Sherman, the Federal warrior, once paid this tribute: "He is in history a strong link between the men who built up this government and those who saved it, in the cruel Civil War. He does possess and enjoy at this moment more of the respect and affection of his fellow-citizens than any living man."

General Towne spoke of General Patterson as the merchant magnate of Philadelphia, and added: "His life

Diary of General Robert Patterson—Born 1792

is an illustration of eminent citizenship in peace and honored soldiership in war.

The beautiful Elizabeth Patterson, of Baltimore, who married Jerome Bonaparte, king of Westphalia, and youngest brother of Napoleon, was a cousin of General Patterson, the writer of the diary here recorded. The general always visited her once a year. Just before her death she sent for him in great haste. They were closeted together for hours, but he could never be induced to tell what the conversation was about, and many were the family speculations on the subject.

Elizabeth Patterson was considered the "handsomest woman in America." Her romance with the brother of the emperor has become history. They were married with all the requisite legal formalities, in 1803, by Archbishop Carroll. She sailed for Europe in 1805 to meet the royal family but the opposition of Napoleon prevented her from landing and she fled to England for refuge. The emperor declared her marriage with his brother annulled, through his council of state, and, in 1807, just one hundred years ago, her former husband was made king of Westphalia, and commanded a division at Waterloo, only to be finally exiled with the downfall of his brother.

A brother-in-law of Elizabeth Patterson, through her royal marriage, was Joseph Bonaparte, the elder brother of Napoleon, who was made king of Spain, in 1808, just one hundred years ago next year. After the defeat at Waterloo, he fled to America and lived at Bordentown, New Jersey, where he became intimate with the Pattersons of Baltimore and Philadelphia. While the former king of Spain was living at Bordentown, he was a frequent visitor at General Patterson's home in Philadelphia. The tall candelabra now in the Blue Room of the White House were originally presented by Napoleon to Joseph when he was made king of Spain.

When he fled to this country, he gave them to General Patterson, who, feeling that such historic treasures should belong to the nation, gave them to the White House when his friend, General Jackson, was made president. The smaller candelabra to match are still in the family. At the sale of the Bonaparte effects, General Patterson bought the dinner service of royal Sevres. Each plate is decorated with scenes from Napoleon's battles. They are now on exhibition at the Exposition in Virginia, under the loan of General Patterson's granddaughter, Mrs. Lindsay Patterson, who is chairman of the North Carolina historical commission, and who transcribes the portions of her distinguished grandfather's diary for these pages.

William Perrine, in relating the lives of distinguished Americans in "Old Philadelphia" gives this eminence to General Patterson: He was a Philadelphian whom few men equalled in the impress he made upon that city throughout an unusually long life. As a merchant, a man of affairs, a millionaire capitalist, a clubman, a promoter, a veteran of the War of 1812, the Mexican and Civil War; a host under whose roof-tree gathered the army, the navy, the volunteer service, the political, scientific, pioneer and social life not only of this country but of Europe, there was no phase in Philadelphia activity in which he did not play a part. From youth to old age there were few civic occasions of note, and certainly no military ones, in which he was not foremost among the leaders. In his strong face, his keen eyes, his penetrating voice, his firm mouth and erect figure there was the manner of natural leadership and command. Long after he was past eighty years of age he might be seen every morning in his little counting-room on Chestnut street, the busiest man in the establishment, often before his clerks had rubbed the sleep out of their eyes. Then it was that the venerable gentleman received his visitors in a dress-

Observations of an Early American Capitalist

ing gown, and on his head a Scotch cap—you imagined a cross between a Carlyle and a von Moltke—but with all that Kent read in the eyes of old Lear, authority and distinction. At one moment he might burst forth with a torrent of irascible eloquence, such as Kent's royal master could hardly have exceeded in its majestic rage; and when it was all over, he might be seen shaking the contents of the coal scuttle into the office stove and then turning to transactions involving millions of dollars.

His hard-headed common-sense, his incisiveness of speech, his well-disciplined methods in the mastery of details, his tremendous capacity for work, first exhibited in the drudgery of the counting-rooms in his China and East India trade early in the century, his indomitable civic spirit and the social quality in his virile fibre brought him success as a man of affairs in Philadelphia before he was hardly more than thirty years of age. A captain in the War of 1812, he there acquired the lifelong friendship of such subsequently distinguished soldiers as Scott, Gaines, Zachary Taylor, Leavenworth, Dearborn, Riley, Croghan and others. Resigning from the army in 1815, he went into business on High street, and this business afterwards developed into many ramifications. The wholesale purchase of sugar led him into the sugar-growing districts of the South, first as a buyer and then as a planter on his own account. Pattersonville, Louisiana, where he owned large estates, was named for him. In time his attention was directed to the cotton trade in which he became a grower in the South and a manufacturer in the North. During one period of his life he was the owner or the operator of not fewer than thirty cotton mills. Time and again he was called upon to give his aid to the big enterprises that developed Philadelphia from 1825 to 1860. Sixty years ago he was at the head of the company which opened railroad



COLONEL WILLIAM HOUSTON PATTERSON
—Son of the Philadelphia Financier who transcribed His Father's Journal, and from whose collection of rare prints, letters, photographs and memoirs, this sketch is compiled by his daughter

communications with Baltimore; one of his chief functions was as a member of the Board of Canal Commissioners; much of his money, together with that of his younger brother, William C. Patterson, who was president of the Pennsylvania Railroad Company, in its infancy, went into the construction of that road, and he was one of the first to take part in introducing steamships into our commerce with the South and with Europe. For many years he was at the head of the cotton mill industry.

General Patterson had the unique experience of having been twice appointed president of the board of visitors to West Point, being appointed the first time by General Jackson in 1835, and again by President Hayes after an interval of fifty years. The ovation given him on the latter occasion by the enthusiastic corps of cadets is said to have been unequalled in the history of the Academy.

The civic honor that he most appreciated was upon the critical political occasion of the contested electoral

Diary of General Robert Patterson—Born 1792

vote which was decided in favor of Hayes. President Grant called General Patterson to Washington to mediate with the Southern members of Congress. During his stay in Washington he was introduced to the Senate, upon the floor of the Senate Chamber, by John Sherman, and the Senate rose as one man to receive him.

The "little white marble palace," as the Patterson mansion at Thirteenth and Locust streets was called, has been torn down to make room for "modern improvements." There probably is not another house in Philadelphia in which so many distinguished Americans of the last three generations have been gathered as within the walls of this mansion. General Patterson knew all, and certainly entertained most of, the presidents of the United States, from Jefferson to Garfield. He was still a young man when he took part here in receiving Lafayette, and later Monroe, on that famous journey which began the short-lived era of good feeling. Indeed, the soundness of the general's intellect in his advancing years caused him to be called the "evergreen of the old men of Philadelphia"—paralleled by only a few such instances as Horace Binney, Francis Gurney Smith, Thomas Sully, William Henry Furness and Frederick Fraley. In the prime of his life he stood by the side of Andrew Jackson on the day when the Philadelphia democracy threw open the town to "Old Hickory;" and when James K. Polk came to the city, while president, the dinner and great ball at the Patterson mansion closed the festal tributes to the Tennessee statesman.

In the conversations of his daughter, Mrs. Louise H. Lynde, and in the memoirs of his son, Colonel William Houston Patterson, both of whom have since "fallen asleep," frequent allusions were made to the most interesting of the many visitors who were entertained by General Patterson:

Lafayette, the Duke of Saxe-Weimar, Keokuk and Black Hawk, chiefs of the Sac and Fox nations, and fifty of their warriors; Joseph Bonaparte, Captain Francis Marryatt, G. P. R. James, Cass, Marcy, Gaines, Breckinridge, Stockton, Charles Dickens, Sam Houston, Henry Schoolcraft and his gentle Indian wife, Major Croghan, the hero of Fort Sandusky; Thomas H. Benton, du Chaillu; Webster, Henry Clay, Tupper, Lord Houghton, General Sir Charles Wyndham, the hero of the Crimea; Mrs. Chase, the heroine of Tampico; Generals Scott and Taylor, Jesse D. Elliott, "that human naval cyclone whose controversy with Captain Perry shook the navy department to its center;" Seth Williams, "Prince John" Magruder, "Gettysburg" Pickett, Grant, Fitz John Porter, "the martyr of the Civil War;" John Mercer Brooke, the planner of the Confederate ram, "Merrimac." The list is almost endless.

Robert Patterson was born in the town of Strabane, County Tyrone, Ireland, on the twelfth day of January, 1792, and passed away at his home in Philadelphia on the eleventh of August, 1881, in the ninetieth year of his age. He was the eldest son of Francis Patterson and Ann Graham. His paternal grandparents were Robert Patterson and Ann Fullerton; (maternal) Thomas Graham and Jean McBeth. Of the family history in Ireland little has been retained, save the tombs in the Strabane church-yard, which testify, in their inscriptions and surmounting reproductions of family coats of arms, that Robert Patterson was of gentle blood. Francis Patterson with his bosom friends, Wolfe Tone and Robert Emmett, had plunged, as an "United Man," into the Irish troubles of 1798, had become seriously involved therein; was arrested by the English government, tried after the peculiar methods of the period, and sentenced to be hanged. The loyalty of the Grahams to the Crown and the influ-

Observations of an Early American Capitalist



GENERAL PATTERSON ENTERTAINING DISTINGUISHED AMERICANS AT HIS PHILADELPHIA MANSION—Members and Guests of the Aztec Club at an anniversary dinner given by General Robert Patterson, president of the club—This rare photograph was taken as the celebrities were gathered on the veranda overlooking the flower garden—At the left of General Patterson is General Grant—The other guests are General George A. H. Blake, General Z. B. Town, General J. J. Abercromble, General C. E. Babcock, General William F. Barry, General Cadmus M. Wilcox, General Fitz John Porter, General I. G. Barnard, General O. L. Shepherd, General William H. French, Governor M. L. Gonham, Colonel Charles I. Biddle, Surgeon John M. Cuyler, Major-General T. L. Alexander, Lieutenant-Colonel Fred D. Grant, Captain E. L. F. Hardcastle, Captain Henry Coppee—Richard Harding Davis in his novel, "Captain Macklin," describes this dinner, using this photograph for the basis of his description of the men there gathered—The original is in the collection of the late Colonel William Houston Patterson, and is loaned for this reproduction by his daughter

ence of the Marquis of Abercorn (whose sister had married one of the Grahams), induced the British government to commute the death sentence of Francis Patterson and remould his punishment to perpetual banishment from his native land. With his family he reached America in the autumn of 1798, settling in Delaware County, Pennsylvania. His son, Robert, at the age of fifteen, entered the counting-room of a Mr. Thompson, in the East India trade, retiring at the age of eighteen to take part in the War of 1812.

In 1817, he married Sarah Engle, of Germantown, Pennsylvania, a

Quaker beauty, a gifted musician, a brilliantly intellectual woman, whose love for society and gracious charm of manner rendered her a fit helpmeet for her distinguished husband. She was very fond of Scott's poems, and when bed-time came, put her children to sleep reciting cantos of "Lady of the Lake." Just before her death, when both paralyzed and blind, a loved one was grieving over her condition. Her answer was never forgotten:

The soul's dark cottage, battered and decayed,
Lets in new light through chinks that time
has made.

An Early Journey in the Mississippi Valley

Accurate Transcript from Diary of General Robert Patterson of Philadelphia, describing his Tour through Virginia, Tennessee, Kentucky, the Ohio and Mississippi Rivers and the Great Lakes

Chapter XII

Mouth of Bad Axe - Battle of that name - Cross River - Sloups of the natives - General Young
General Wilkinson's College - Saw into Knoxville - Dragon Camp

July 19th Reached the mouth of Bad Axe before morning. It comes in on the eastern shore and is the place where the Indians and Kips, who under Black Hawk had taken up arms against the Government in 1832, received the faithful which enabled them as a nation. The circumstances connected with the engagement are these

The line of march was taken up on the morning of the 26th of August, at 2 o'clock, Colonel Dodge's command forming the advance, supported by the regular troops under Colonel Zachary Taylor. About sunrise the army camped. They were up with the enemy, orders were given for an immediate advance and attack, and the line having been formed, it was ordered to advance to the cliffs of the Mississippi, near the mouth of the Bad Axe river, where the battle took place. At this point was situated Black Hawk's retreating band of Indians, men, women, and children, endeavoring to make their escape from their justly opposed and most highly excited enemy, and there was to be made the desperate cover of Black Hawk, together with the distances, massacres, and depredations consequent to his detestable handling and unscrupulous course. This was to be the last of the bloody battles and loss of human life of which the miserable victims of Black Hawk had been the occasion.

On the morning after the battle of Wisconsin Heights (July 21st), Captain James B. Esler had been dispatched with information to Prairie du Rocher, at which place he arrived by noon of the 23rd of July. Col. Lewis, then in command of Fort Crawford and the steamboat Enterprise, of Orleans, on the Mississippi to Black River. At Black River they found forty Kinnikinnick and their boats, which were collected there and then to aid the retreating Indians to cross the Mississippi. These Kinnikinnicks and their canoes were seized and brought down to Fort Crawford on the 30th of July. The Enterprise being a slow boat, Colonel Lewis hired the steamboat Warner to go up the river a second time. On the 6th of August this boat ascended the river (about forty miles) to the mouth of Bad Axe River, and here found the Indians on the east bank of the Mississippi, who commenced firing on the boat; the fire was returned from the boat with a six pounder, and the Indians fled with the words "The boat returned the same weight to Prairie du Rocher for wood, and, having procured it, started back about midnight and arrived at the lower end of the large island below the mouth of Bad Axe, about ten o'clock in the morning of the 2d of August; they having found before they reached the island: the battle had already begun.

There are two islands in the Mississippi near the mouth of Bad Axe, many of the Indians had been driven to these islands by our troops. The steamboat opened a fire upon them with her six pounder, and Captain Thompson's (and her small boat) were to bring our troops over to the islands. Two trips were made, and Colonel Zachary Taylor with his regulars, about one hundred and fifty men, landed on the large island, and nearly all the Indians found upon it were killed.

The distance from the main shore to the islands is about 150 yards; it appeared that the Indians had had no canoe with them, and they had to swim across the straits, so that many of them were drowned, as their bodies were found next day below the islands.

Transcribed by his son, the late Colonel William Houston Patterson, of Philadelphia

Observations of an Early American Capitalist



“OLD WILDERNESS ROAD” AT CUMBERLAND GAP IN EAST TENNESSEE

It was through this Gap that Daniel Boone passed on his first journey to Kentucky in 1769—General Patterson passed through it in his early journeys described in his diary—This rare photograph is loaned from the collection of the late Colonel William Houston Patterson, of Philadelphia, son of General Patterson

MAY 23. Left Philadelphia in the six o'clock boat. The morning was clear and bracing but very cold for the season. The steamboat was crowded, having on board the cabin passengers of the Packet ship “Susquehanna” about to sail for England, and from the period of leaving the wharf at Chestnut street until we arrived at Newcastle, there was a continuous scene of shaking hands, bidding farewell, wishing a pleasant voyage, etc., etc., with here and there a sprinkling of tears and red eyes. Quite a number of the mourners supposed that we also were going to England, and when told our destination was the West and Falls of St. Anthony, were surprised at our hardihood and want of taste. Arrived at Newcastle. We took the cars over the Newcastle and

Frenchtown R. Road, a single track, seventeen miles in length and nearly parallel with the Delaware and Chesapeake Canal to Frenchtown. At the latter place again took the steamboat and passed down the Elk river and



GATHERING PLACE OF MANY NOTABLES
Old Patterson Mansion in Philadelphia—The mirrors in the drawing room once belonged to Washington—The marble mantles were once owned by Joseph Bonaparte, the brother of the Emperor Napoleon

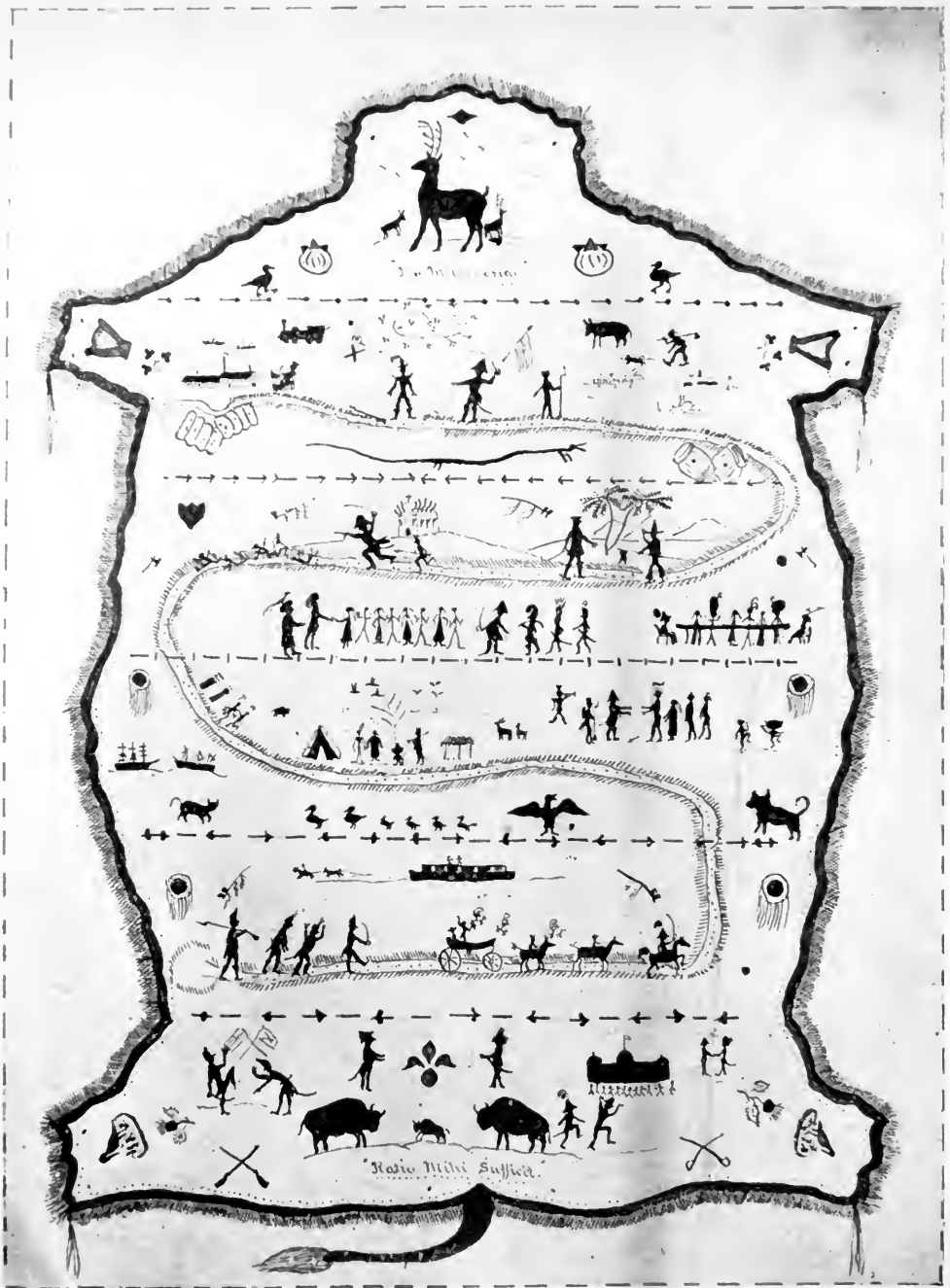

HIEROGLYPHIC NARRATIVE OF CAREER OF GENERAL ROBERT PATTERSON

Reproduction from Original made by his son, Colonel William Houston Patterson, in imitation of the character writing of the American aborigines - Interpretation: the shamrock and thistle denote Scotch-Irish ancestry; pelican and scallop shell represent Patterson and Graham coats-of-arm; buffalo, deer and wild fowl signify his love of hunting; the scalps, his prowess as a warrior - Beginning in the lower left corner these events are typified: General Patterson capturing British in War of 1812; his reception to Lafayette; trip west in a canal boat; reception to Keokuk, Black Hawk and the Indian warriors; camping in Iowa in the early part of last century; the "Buckshot War;" reception to President Polk; dinner to officers of the Coldstream Guards; "native American riots" and burning of Catholic churches in Philadelphia; experiences in Mexican War and peace treaty; development of sugar and cotton trade in the South; Civil War in the United States; his closing career as financier in industry, transportation and commerce in first days of the American Nation

Observations of an Early American Capitalist

Chesapeake bay and up the Patapsco river to Baltimore, sixty miles, where we arrived about 3 o'clock.

May 24th. Left Baltimore at 9 o'clock for Washington, where we arrived a little after 2 o'clock. In the afternoon I called on the president (Gen. Jackson) and had a long conversation with him, during which he evinced his usual decision and judgment. He invited the ladies and myself to dine with him at four o'clock on the following day.

May 25th. At four o'clock we went to the President's. The party was small, comprising only the General's family and ourselves. The dinner was very neat and served in excellent taste, while the wines were of the choicest qualities. The President himself dined on the simplest fare—bread and milk and a few vegetables. After dinner we took a walk through the grounds about the White House, which are laid out with much neatness and order and filled with shrubs and flowers.

The President's mansion is an elegant but not imposing edifice, built of freestone painted white. . . . After spending some time in conversation we returned to our hotel.

The president is one of the most agreeable and polished gentlemen I ever knew. In his home he shows the open-hearted and kind friend, while on his face candor and decision are strongly marked. Locks that are becoming silvery with age give him a venerable appearance, while the arm once so nobly wielded in defence of his country is reduced to a mere shadow and his bodily strength much enervated. In one who has been taught to look upon the hero of New Orleans with a reverence only equalled by that entertained for the memory of the Father of his Country, these mute witnesses of advancing years serve but to make the sentiment tenfold stronger. (The journal does not mention the incident, but this was probably the time when General Patterson presented to the White House

the gilded bronze candelabra, now in the Blue Room. They were originally given by Napoleon to his brother Joseph, and by him to General Patterson, who, in turn, feeling that such historic treasures should belong to the Nation, presented them to the White House.

May 26th. Left Washington about daylight on the steamboat "Champion," a very swift boat, for Fredericksburg. We had on board a large number of the Virginia and North Carolina delegates returning from the Baltimore Convention and in no very good humor at the defeat of Rives who appears to be very popular.

Passed Fort Washington, a place that appears to be strongly defended by nature and art. Nearly opposite on the western shore is Mt. Vernon, sacred as the home and tomb of Washington. It is now owned by Judge Washington, the General's nephew. . . .

From the Potomac landing to Fredericksburg, we passed innumerable quantities of flowers. It was in the vicinity of Fredericksburg that Washington was born and here he passed his early years, and here, too, repose, beneath an unfinished monument, the remains of his honored mother. The birthplace of the Father of his Country is about half a mile from the junction of Pope's Creek with the Potomac in Westmoreland County. It is upon the Wakefield estate.

The house in which the great patriot was born was destroyed before the revolution. It was a plain Virginia farmhouse of the better class, with four rooms and an enormous chimney on the outside, at each end. The spot where it once stood is now marked by a slab of freestone, which was deposited by Geo. W. P. Curtis, Esq., in the presence of other gentlemen in June 1815. "Desirous" says Mr. Curtis, in a letter on the subject to Mr. Lossing, "of making the ceremonial of depositing the stone, as imposing as circumstances would permit, we enveloped it in the Star Span-

Diary of General Robert Patterson—Born 1792

gled Banner of our country and it was borne to its resting place, in the arms of the descendants of four patriots and soldiers. We gathered together the bricks of the ancient chimney, which once formed the hearth around which Washington in his infancy had played, and constructed a rude kind of pedestal, on which we reverently placed the first stone, commending it to the respect and protection of the American people in general and those of Westmoreland in particular. On the tallest is the simplest inscription: "Here the 11th of February (O. S.) 1732, George Washington was born." The mother of Washington resided, during the latter part of her life, in Fredericksburg near the spot where she now lies buried, and which she herself, years before her death, selected for her grave, and to which she was wont to retire for private and devotional thought. It is marked by an unfinished monument, the corner stone of which was laid by our present Chief Magistrate on the 7th May, 1833, in the presence of a great concourse, and with most solemn ceremonial. The house of her abode is on the corner of Charles and Lewis Streets. It was here that her last interview with her illustrious son took place when she was bowed down with age and disease.

Left Fredericksburg at 12 o'clock and dined at the first change of horses, ten miles beyond. Our ride this afternoon was through an uninteresting country. Five miles from Orange C. H. were detained more than an hour as our driver was ignorant of the road and fearful of washes and apprehensive of danger. About 9 o'clock we reached Orange C. H. and were comfortably accommodated for the night.

May 27th. Started in the stage before day and rode thirteen miles before breakfast. Our meal was served in a room used in winter for corn and in summer for an eating room. Breakfast concluded, we moved on.

The day was pleasant and we had a delightful drive through a rich and highly cultivated country. Passed Monticello, the late residence of Mr. Jefferson, also the seats of Mr. Madison, P. P., Mr. James Barbour, Mr. Rives, and others.

Monticello, once the beautiful home and now the tomb of Jefferson, is situated about four miles east of Charlottesville, upon an eminence, with many aspen trees around it, and commands a view of the Blue Ridge for one hundred and fifty miles on one side and on the other one of the most beautiful and extensive landscapes in the world.

Monticello was a point of great attraction to the learned of all lands, when traveling in this country while Jefferson lived. His writings made him favorably known as a scholar and his public position made him honored by the nations. Wirt, writing of the interior arrangements of the house, during Mr. Jefferson's life time, records that in the spacious and lofty hall which opens to the visitors in entering, he "marks no tawdy and unmeaning ornaments, but before, on the right, on the left, all around, the eye is struck and gratified by objects of science and taste so classed and arranged as to produce the finest effect. On one side specimens of sculpture, set out in such order as to exhibit at a coup d'ceil, the historic progress of the art, from the first rude attempt of the aborigines of the country, up to that exquisite and finished bust of the great patriot himself from the master hand of Carrachi.

"On the other side the visitor sees displayed a vast collection of the specimens of the Indian art, their paintings, weapons, ornaments and manufactures; on another an array of fossils of our country, mineral and animal; the petrified remains of those colossal monsters which once trod our forests and are no more; and a variegated display of the branching honors of the monarchs of the waste that still people the wilds of the American

Observations of an Early American Capitalist

continent." Wirt tells of being "in a large room, with exquisite productions of the painted art, and from its windows opened a view of the surrounding country that no painting could imitate. Here too were medallions and engravings in great profusion."

Changed stages at Charlottesville; took a view of the town and University and set off again on our road toward Lynchburg. The University of Virginia is one of the most distinguished of the colleges of the United States. . . . It was founded in 1819 by Thomas Jefferson and so great was his interest in its success and his estimate of its importance, that in his epitaph, found among his papers, he ranked his share in its foundation, third among the achievements and honors of his life—the authorship of the Declaration of Independence being the first, and of the Virginia statute for Religious Freedom, the second.

The University is controlled and endowed by the State.

Crossed in our afternoon drive the Rockfish river in several places. The scenery all along its banks is wild and very beautiful. The ivy, or mountain laurel, the magnolia and fringe were all in full bloom. The magnolia clustered all along the banks, with the ivy and fringe crowning the magnolia, and the whole o'ershadowed by the forest trees, presented a rich effect. Shortly after dark, we arrived at Nelson C. H. and put up at an excellent tavern for the night.

May 28. Left Nelson C. H. about 2 o'clock in the morning and rode to New Glasgow to breakfast stopping at a mean tavern to obtain a meaner meal. I omitted yesterday to mention that at our dining place, we met Mr. Rives and had a long conversation with him, the driver of the stage being kind enough to wait until it suited our convenience to go on. Mr. Rives was returning from an Episcopal convention at Lynchburg and learned from us the result of the

nomination at Baltimore. I was struck with his temper and moderation. To Lynchburg to dinner. It is not a handsome town but does a considerable business, being the center of the tobacco trade for several counties and ought to do a large forwarding business for western Virginia. We travelled late in the day and it was 10 o'clock before we got to our journey's end.

May 29th. Started a little before dawn, having been detained some time by a magpie in petticoats who had joined us at Lynchburg and to our great annoyance was to be our travelling companion as far as Christianburg. Rode fourteen miles to breakfast. Changed stages and commenced crossing the Blue Ridge. On the Ridge the ivy was very thick, both slopes were covered, forming a beautiful contrast with the tulip tree which bears a deep orange and yellow cup-shaped flower.

Passed Big Lick and dined at Salem. . . . Reached the latter place in time to connect with the Lexington line of stages and were fortunate enough to secure good seats. The Lynchburg route is pleasanter than the one by Lexington, the roads being much easier. Left Salem at 12 o'clock for Christianburg where we were to stay all night. The Allegheny is full of the locust and fringe trees, and close to them grows a wild flock and a small shrub of a different class, the flower of which resembles that of the geranium in form and color, while the leaf is very different, being sharp and pointed and growing in a single stalk a foot in height. During the afternoon crossed the Roanoke nine times. . . .

May 31. Left at daybreak, and went to Lexington C. H. to breakfast.

Crossed and forded the Holston several times. Along its bank were clustered the black haw and hawthorne in great abundance. . . .

At the ford of the north fork of the Holston, a main tributary of the Tennessee, there is a fine bottom land

Diary of General Robert Patterson—Born 1792

which is very productive, yielding eighty bushels of maize to the acre. This valuable estate belongs to General Preston, father to the distinguished senator from So. Carolina, Col. Preston. Gen. Preston is a person of the highest respectability and has always been distinguished for great energy of character, without which, no man under the circumstances of the period when he first came here, would have advanced into so unsettled a wilderness as this was. He is now a very opulent land holder and can count one hundred and sixty two descendants.

June 1st. Having disposed of our breakfast we left Abingdon about 9 o'clock. It being Sunday morning, and the stage going but half the distance, we did not start as early as usual, and then moved leisurely on to Blountville.

About four o'clock in the afternoon a funeral passed through the town. The corpse was in a wagon, covered with a counterpane. Part of the mourners were in carriages, the remainder were on horseback. There was no attempt at solemnity in the proceedings.

June 2. Started at 1 o'clock and went eleven miles to breakfast. The roads being bad made slow driving and were nearly upsetting several times. Passed Kingsport (the boat yard) on the Holston. The river at this place is very broad and deep. Although a number of boats are loaded between this place and the mouth of the Watauga, yet it is considered the head of navigation.

Dined at Rogersville, the seat of justice of Hawkins Co. On the 5th day of November 1791 a printing press was established at this place by a Mr. Roulstone and a paper issued entitled the *Knoxville Gazette*, being the first paper ever printed in the territory. In 1833, Rogersville contained 300 inhabitants, four lawyers, two doctors, one academy, seven stores, three taverns, six blacksmiths, three bricklayers, four carpenters,

four cabinet makers, two painters, two hatters, four tailors, four shoemakers, two saddlers, one silver smith, three tanners, one tinker and four wagon makers.

Two and a half miles east of North Rogersville is a hill composed wholly of marble, white, gray and sometimes red. There is a similar hill on the road eight miles west of the town. Reached Bean's station, where we staid all night.

June 3rd. Rose at 3 o'clock and riding to the foot of Clinch Mountain (about a mile) commenced the ascent. As the baggage was heavy the gentlemen agreed to walk and . . . Along the northern slope of this mountain a vein of gray and variegated marble extends for fifty miles. About a mile beyond the Clinch ford my brother James met us with horses and about 10 o'clock, we arrived in Tazewell, where we had the pleasure of finding our friends and relatives all in good health.

June 11th. Went over to my father's place on Sycamore and had the satisfaction of once more embracing my good and venerable parents. . . .

June 17th. Left Tazewell; my father and Dr. Fulkerson accompanied me, the former about six miles when we urged him to return, fearing the long ride would do him no service. Our emotions at parting were most painful. My father was far advanced in years, becoming feeble, and could not, in the course of nature, last much longer, while I was going on a long journey in search of health I might not find. Both felt as if we were looking on the other for the last time, and as we embraced, neither could speak. A long time will elapse ere the parting scene will be effaced from my memory. After we had separated I could observe my father looking after us as long as we could be seen. Dr. Fulkerson continued with me until we reached the foot of Cumberland Mountain, when he also took leave and I pursued my solitary way across the mountains into Ken-

Observations of an Early American Capitalist

tucky. The scenery at the Gap is magnificent. On the one side, spread out at your feet is the rich valley of Kentucky, stretching away as far as the eye will reach, while on the other are the hills and valleys of East Tennessee. It was through this gap that Daniel Boone passed on his first visit to Kentucky and one can but echo his expression when looking for the first time on the scene of his triumph, that it was a country worth fighting for. The first visit of Boone to the wilderness of Kentucky was about the year 1769 at which period he and his hardy companions made the earliest settlement at Boonesborough. In 1774 Harrodsburg was begun and Lexington a year or two afterwards. . . .

A memorable battle was fought near the Bluelick Springs August 19th, 1782, between the Kentuckians and the Indians. An unequal and disastrous conflict in which the colonists were routed with a loss of sixty men, among them a son of the gallant Boone. . . . In the Gap, near the point where the road dips to descend the mountain, and on the verge of the road itself, is a huge isolated rock to which tradition has imparted an interest not shared by its larger and smaller brethren in the neighborhood. When this entire country was a wilderness of forests and the pioneers were guided in their movements by their knowledge of woodcraft alone, with not even a sheep track to guide their steps, this rock was selected by the savages as a favorite position to waylay the unsuspecting woodsman on his journey across the mountain. Many are said to have fallen victims by that fatal rock and it was not until the country became cleared and a road opened exposing the ground around this death pass, that the spot ceased to be an object of dread. Its singular formation, being cleft in the center, rendered the position peculiarly favorable for the purpose for which the natives had selected it. Tradition further says that two of the victims (white men) were buried be-

neath the rock. (One was Elkanah Bramlette, from Bedford County, Virginia.) . . . Crossing the Cumberland river at a point some fifteen miles above Barboursville, I kept along its margin until I reached that town. It had not been my intention to travel so far that day but being mounted on Messenger, a blooded mare of my brother's that walked faster than any animal I had ever ridden, I felt some curiosity to try her power. I left Tazewell at 7 o'clock and reached Barboursville at 25 minutes after 6 o'clock, accomplishing without feeding or going out of a walk, 44 miles in eleven hours, less five minutes, crossing on the route Cumberland Mountain and some difficult hills. . . . There were immense cane brakes in this section in former times but they have been destroyed by the cattle of the settlers. In places inaccessible to cattle, the cane is still found. This is the "old wilderness road" the country between Cumberland and the Crab Orchard still bearing the name, being thickly settled and abounding in game. It is said that there are more deer in this region than in any section of the Union.

June 18th. Left Barboursville for Williamsburg. . . . The greater portion of the road was nothing but a bridle path. Would never have found my way but for the guidance of the mail carrier. The timber through which we passed was very heavy and in some places so dense as to exclude the sun. Had again to ford the Cumberland which was so deep as to wet our saddle bags. Reached Williamsburg at 3 o'clock. . . . While there I received some singular illustrations of the ridiculous extent to which so called mail facilities have been carried in the West.

A mail from Barboursville to Monticello, passes through Williamsburg twice a week—once each way. The annual carriage amounts to about one hundred letters, while the Government pays the contractor \$600.

Diary of General Robert Patterson—Born 1792

There is also a cross mail running to a certain Martin Beatty's (a member of Congress) over which route the mail-rider told me a letter had not passed for three months. He also informed me that there was not a house within eleven miles of the office, and to the best of his knowledge and belief there had never been a letter or paper taken there for any other person than Martin Beatty or some one in his employ, so that it would appear as if the office had been established and the contract given for the exclusive benefit of Mr. Beatty, who is thus paid a commission for receiving his own letters.

On my arrival at Williamsburg, I sent for Judge Eve who was holding court there. He came immediately and after some conversation, agreed to adjourn court and go with me next morning to the mouth of Rock Castle, where at the coal banks, I expected to find General ——. Our road today led through a wilderness—we saw but one house in 35 miles. . . . In crossing Laurel, we missed the trail and had to break our way over and around stumps and fallen trees, scramble up one ravine and down another, climbing up and sliding down rocks until our horses, although first rate animals, were completely worn out. At last we reached the mouth of Rock Castle. Found General — at a saw mill he had erected some miles above the coal banks. His establishment presented an odd mixture of pride and poverty, extravagance and meanness; himself attired in a good suit of blue cloth, his wife in a handsome chintz, while his little son was dressed in a full city suit and sported a polished leather belt with a gilt buckle, while the trio resided in a slab cabin with a superior mud floor. Two negroes waited on them. At the saw mill the General had three men to help him do work that in Pennsylvania would have been undertaken by one individual. During the evening and on the following morning every effort was made by Judge Eve

and myself to produce from General — money or property for the debt he owed me, but in vain. All we could get was a judgment. During the night a violent storm of rain and hail arose, the rain beat in through the slabs, the atmosphere changed from extreme heat to extreme cold and our situation became anything but a comfortable one.

June 20. After breakfast left Rock Castle to return to Barboursville fully impressed with the conviction that in the year 1835, there was not a greater scoundrel in Kentucky than General ——. After riding about 20 or 30 miles we came to a farm house and alighted to get some refreshment for ourselves and horses. I was amused with the judge's dexterity in bed making; a bear skin spread on the floor with his saddle for a pillow constituted a pallet on which we took a comfortable rest, while the good lady of the house broiled some chicken, with ham and eggs on which we made a comfortable dinner, closing with a dessert of cherry pie, honey and sweet milk, after which we mounted our nags and resumed our journey towards Barboursville, where we arrived about dark.

Judge Eve insisted that during my stay I should consider his house my home, and I accepted the invitation. Mrs. Eve I found a very ladylike woman and a good housekeeper. Everything was done to render my stay agreeable, and while in Barboursville, I was the recipient of the most attentive kindness from Judge and Mrs. Eve and from every member of their connection.

June 21st. The day was so cold we had fires and wore great coats. There was no church and the day was spent as most Sundays are under the circumstances—in walking about and talking politics. There was service about five miles off, but I was too much fatigued with the exertions of the previous day to attend. A number of the gentlemen of Barboursville called and invited me to their houses.

Observations of an Early American Capitalist

June 22nd. Was the first day of court-week, and as customary all the surrounding country came to town. Most of the lawyers I had met at Williamsburg. As I had nothing to do, the Judge invited me to come to court and take a seat on the bench, to which I acceded, knowing the scene in the court would afford me both amusement and instruction. The Bar was composed of intelligent, common-sense men, possessing a great deal of tact and judgment. The Judge presided with ability and despatched business promptly and correctly.

June 23rd. Following yesterday's programme, went to court. While in the court house could not help but recall Mrs. Trollope's tirade on tobacco chewing. Here every one chews, and the floor was reeking with little pools of tobacco juice, or "amber" as the natives called it. While the court was in session a fight was improvised at the door. I was desirous of seeing a real knock-down, drag out, bite and gouge Kentucky fight, but the Judge was not disposed to encourage such "gentle passages of arms" and sent some officers to bring the combatants into court. When, to his astonishment, he learned that one of them was his particular friend, Col. Garrard, who had dined with us the day before, and was withal the favorite candidate of the Judge for Congress. The quarrel originated in politics. When the participants were brought in, covered with dirt and scratches they looked somewhat furious, but were evidently ashamed. The Judge reprimanded them and charged each ten dollars when they left the court.

In the afternoon I took leave of my friends and after tea, conveyed my baggage and myself to the stage house. The stage arrived about midnight. . . . Reached Crab Orchard about dusk and put up at most excellent house. . . . The place derives its name from the number of wild crab apple trees that were found in the vicinity at the period of its first

settlement. Immense thickets are still found in the neighborhood. . . . We crossed today the Rockcastle river, the shores of which were covered with water laurel and wild cucumber. The latter grows to a tree of considerable size bearing a very large white flower.

June 25th. . . . Reached Lancaster about 12 o'clock. The macadamized road from thence to Louisville may revive the place. This road is graded as far as Lancaster but the stone has not been laid.

Rode to Smith's beyond Lancaster to dinner, the only one that reminded one of a Pennsylvania farmer. The place was in excellent order, and marked by a neatness entirely different from all other farms I had seen.

June 26th. . . . Left Nicholasville about 2 o'clock and arrived at Lexington about 5 o'clock. The country through which we passed was a perfect Paradise, especially as we approached Lexington, everything indicated fine farms and fine farmers. The grass fields and hemp meadows were luxuriant while the woodlands were free from undergrowth and beneath was a rich carpet of the famed blue grass, the whole fenced in to preserve the pasture. Here and there under the trees, noble cattle were leisurely cropping the grass; occasionally one would look up and stupidly gaze at us over his moist nose, as we passed. . . . On our return to the hotel about dusk, met Gen. Combs who was very glad to see me and wished me to stay and dine with him but being fearful of losing the boat for the upper Mississippi, I was obliged to decline. . . .

June 27th. Left Lexington about sunrise by rail-car for Frankfort where we arrived about 8½ o'clock, and took breakfast. Would have preferred the stage as enabling us to remark the country through which we passed, more at leisure, but could not have reached Frankfort by that route in time to connect with the Louisville stage. The view from the hills

Diary of General Robert Patterson—Born 1792

ere you enter the town is beautiful. . . . At Frankfort we resumed the stage. . . . Our road towards Louisville lay through a beautiful country over a good macadamized turnpike. . . . Arrived at Louisville in the afternoon sufficiently early to take a walk through the town and look at the steamboats which lined the river front.

It is a well laid out town advantageously placed on the south bank of the Ohio and accessible to the portly steamers that constantly resort to it. . . . The channel of the river where the water is low, is near the north bank, on the shore of the state of Indiana and at such times you can walk with great security to a few islands which are between it and the city. . . . On one of these islands is a surprising abundance of fossils, many of which I had never seen before, and of which I made a rich collection. Most of the beds of limestone are bituminous and the smell in some of them amounts to fetor. Petroleum is found in many cavities and I was informed that where they were engaged in blasting the beds for constructing the canal, they came to places where a gallon of the mineral oil could be collected during the twenty-four hours. The frequency of this phenomenon has led some persons to suppose that all the deposits of bituminous coal are not of vegetable origin. Upon the whole Louisville is a prosperous and agreeable place, and appears to be under government of judicious magistrates. It was laid off by Capt. Thos. Bullitt of Virginia, in August 1773, but no settlement was made until 1778 when a small party arrived here with George Rogers Clark and settled on what is now known as Corn Island, close to the Kentucky shore. After the posts occupied by the British on the Wabash had been taken by General Clark, they removed to the spot on which Louisville now stands, in the fall of the same year. They built a block house here which was subse-

quently removed and a large fort erected in 1782, called Fort Nelson. In 1780, the town was established by an act of the Legislature of Virginia under whose jurisdiction Kentucky then was. At this time the population was only thirty. The Kentuckians are an enterprising, industrious and united people; they inhabit a beautiful country and cultivated a generous soil. With a magnificent river upon their frontier, they can convey their tobacco, pork, corn, and their other various productions to every part of the earth. They seem to have all the elements within themselves of permanent prosperity. Their acknowledged leader is Henry Clay; his name which is so well known throughout the United States operates as a talisman in Kentucky. He is the most extensive farmer, the most spirited, improver of all the breeds of cattle, horses and mules; the most affable of men to all classes. He has never been known to do a mean action either in his public or private capacity. . . .

June 28th. Sunday. After breakfast got a carriage and rode around town and down to Shippings Port to see the Louisville and Portland Canal. This canal was a bold undertaking, in length for about two miles; the excavation for a greater portion of that distance being made through solid rock. It is in some places forty feet deep and of sufficient width to pass steamboats through. The canal is owned by an incorporated company, the General Government holding nearly one half the stock. . . . Little regard seemed to be paid to the day, the greater portion of the stores being open and business transacted as on week days. Engaged a passage on the "Velocipede" for St. Louis and was fortunate enough to secure a passage for each of our company.

Here the old journal begins its interesting narrative of the journey on the Mississippi river, in which is related many incidents of life along America's great way in last century.

The Father of the American Navy

First Commander
of the First Vessel to
Fight Under the American Flag & The
"Lexington," named after the First Battle in the
American Revolution, Captured the First British Ship in the
Struggle for Independence & The Story of Commodore John Barry, Born in 1745

BY

RICHARD M. REILLY

MEMBER OF THE PENNSYLVANIA BAR

IN the War of the Revolution some men made reputations over night. Like the fabled goddess who sprang full-fledged from the foam of the sea, they leaped into prominence by a single act. Others did yeoman service throughout that memorable campaign, but lacked the trumpeter to sound their praises, and were quite content to play their brave parts, rewarded by the consciousness of work well done, and little recking of the verdict of posterity. True worth is always modest and self-effacing. Therefore is it that the chronicler finds his task a pleasing one to piece together the fragments of one of these noble and unassuming lives into a mosaic worthy to hold an honored place in a picture of the period.

Of this type of modest heroes was the subject of this sketch, John Barry, born in Ballysmpson, County Wexford, Ireland, in 1745. His family name, de Barry, suggestive of Normandy origin, is found in Wexford as early as the fourteenth century. Brought up with the salt air in his nostrils, it is easy to understand how, as a lad of fifteen years, he found a place with his uncle, master of a vessel trading out of Wexford. His sea journeys brought him often to Philadelphia, and he is found in his early years in the employ of the merchant princes of their time, the Willings, the Merediths and Cadwalladers, sailing on their vessels in varied capacities. The first record of him as a sea cap-

tain occurs on October 2, 1766, when he became at twenty-one master of a vessel that traded with the Barbadoes Islands. His life on the ocean wave was probably uneventful for the next eight years or more, but when he arrived in Philadelphia, on October 13, 1775, in command of the "Black Prince," much history had been made since his departure the year before. "The embattled farmers of Lexington" had "fired the shot heard 'round the world." Ticonderoga had fallen, Bunker Hill had been fought, and Washington had assumed the command of the Continental Army under the shade of the stately elm in Cambridge.

Barry's arrival in Philadelphia was opportune, the Continental Congress having authorized the purchase and fitting out of two armed cruisers with authority to capture vessels bringing supplies to the British Army. Captain Barry was appointed to the command of one of them, the "Lexington," named after the place of the first land battle. His commission was the first issued by the Marine Committee of Congress, and attests the high reputation that he enjoyed for courage, skill and experience. Much is contained in the simple record that he was the first officer appointed to the first vessel purchased, named after the place of the first battle. He was soon to add again to his record of initiative by reporting to the Marine Committee of Congress the first capture of a British vessel. This was on April 7, 1776, when off the Capes of

Father of the American Navy—John Barry

Virginia, the "Lexington," after a fierce engagement, caused the "Edward" to strike its colors. Philadelphia acclaimed the Irish sea-dog when he brought his prize up the bay four days later. John Adams wrote of it: "We begin to make some figure here in the navy way." And Richard Henry Lee, in a letter describing the event, narrated that the enemy did not submit until he was near sinking. Barry's report of the victory is embraced in a few lines giving the bare details, and concluding, "I have the happiness to acquaint you that all our people behaved with much courage."

In the lower Delaware, Barry hovered with his good ship, lending his aid to protect the merchantmen arriving with supplies on Congress' account from the assaults of the British men-of-war. When this work was scarce, he kept himself and crew from stagnating by sallying out to the capture of ocean prizes. In August, 1776, the "Lady Susan" and the "Betsy," manned by the loyalist Goodriches, of Virginia, fell into his hands, and the proceedings of their condemnation as prizes may be read in the records of Congress of November 7, 1776. We next find our hero in command of the "Effingham," one of the new vessels authorized by Congress. On the day that Captain Barry received his assignment, October 10, 1776, the rank of the officers of the new Continental Navy was fixed, Barry ranking seventh. Captain John Paul Jones was eighteenth on the list, to his extreme chagrin. But Barry and Jones were real sea-fighters, and they were soon to show by their careers of successful daring how impotent is a Congress committee to keep down men of native force and genius.

And now we come to a picturesque event in Barry's career. It is the winter month of December, 1776, when Washington, having been forced out of New York, is making his weary retreat across New Jersey, seeking to put the Delaware between

himself and the British foe. Saddened by the treachery of Lee, who should have co-operated with him, indignant at the Jerseymen, who, instead of flying to his standard, were going over to the Crown, his soldiers, ragged and forlorn—at no time during the war was the situation so desperate for the American cause. The world still wonders at the masterly way in which Washington retrieved the situation, crossing the Delaware on Christmas night amid the floating ice with his little force of 2,500 men, stealing around the enemy's outposts, and in quick succession winning the battles of Trenton and Princeton. Thus was safety plucked from the nettle danger in the most critical stage of the conflict. The English historian, Trevelyan, says of it: "It may be doubted whether so small a number of men ever employed so short a space of time with greater or more lasting results upon the history of the world." In this momentous struggle, Captain Barry bore a noble part. Though a sailor and a commissioned captain, he organized a company of volunteers and aided in the transport of the troops across the icy waters, and was in the thick of the strife at Trenton and Princeton. Thus ably did he sustain the Father of His Country in his and its greatest trial.

We next find Barry after the Trenton campaign engaged in protecting Philadelphia by defensive naval operations. When in September, 1777, the British army entered Philadelphia and Congress fled to Lancaster, Barry, in his vessel, the "Effingham," went down the Delaware to take charge of the business of preventing British vessels from coming up the river. Fierce river fighting followed for the next two months, until the position growing untenable, the American fleet under cover of night, passed up the river in front of the city, losing several of their vessels in the venture. To Barry, who was now in the upper Delaware, is given the credit of projecting the plan for

First Commander of First Vessel in First Fight

destroying the enemy's vessels in the river by floating down machines resembling ship's buoys filled with powder. It failed of its purpose, but the consternation of the British and the fierce cannonading to which the powder kegs were exposed gave rise to the humorous ditty, "The Battle of the Kegs." There was a good laugh at the British expense, as will be seen by a sample verse from the satirical story:

"From morn to night these men of might
Display'd amazing courage;
And when the sun was fairly down,
Retired to eat their porridge."

Barry's restless spirit ill-brooked the inaction to which he was condemned in the Upper Delaware, and he is found in the early part of 1778 inducing the Supreme Executive Council of Pennsylvania, then in Lancaster, to aid the Continental navy in harassing or destroying the British supply vessels coming up the Lower Delaware. On a night in February, he came down with twenty-seven men, in four row-boats, passed Philadelphia unobserved, and captured the British ten-gun ship, the "Alert," with two supply ships, the "Mermaid" and the "Kitty." The dauntless Barry, with only a few more than a score of followers, leaped over the rail of the "Alert," cutlass in hand, and succeeded in capturing the entire crew of one hundred and sixteen men. The fame of this exploit, together with the masterly style in which, against great odds, he avoided the recapture of the "Alert" by a British sloop-of-war, added new laurels to the intrepid sea captain. It is said that as a result of it, Sir William Howe, then Commander-in-Chief of the British forces in America, offered Barry 20,000 guineas and the command of a British frigate, if he would go over to the English service. Barry's reply was brief and patriotic: "Not the value and command of the whole British fleet can seduce me from the cause of my country." Washington, at Valley Forge, was a close observer of Barry's work at this time, as he

received much forage and supplies from him for his army. Under date of March 12, 1778, he thus writes our hero: "I . . . congratulate you on the success which has crowned your gallantry and address in the late attack upon the enemy's ships. Although circumstances have prevented you from reaping the full benefit of your conquests, yet there is ample consolation in the degree of glory which you have acquired."

Barry's next adventure, while not successful, showed him a genuine specimen of the fighting race. He had been appointed to the command of the "Raleigh," of thirty-two guns, in September, 1778, and within a few hours after sailing was in a fierce fight with two English ships, one being of sixty-four guns. The conflict kept up until midnight, and Barry was compelled to set fire to his ship, himself and the greater part of his crew escaping to an island of the Penobscot. It was a brave fight against heavy odds, and the Marine Committee of Congress publicly complimented him for his "great gallantry."

We next see him directed by Congress to take command of an expedition against East Florida, where disaffection had been spreading. But the sailing of Sir Henry Clinton's fleet southward from New York, with reinforcements, caused a change in the plans, and the proposed expedition was abandoned. For the greater part of the year 1779, he commanded the letter of marque brig, the "Delaware," capturing a man-of-war and several merchantmen. The treaty of alliance with France in February, 1778, gave its name to Barry's next command, the "Alliance," which was the largest and best of the vessels of the Continental navy. We are tempted to smile just a little at this eulogy of her by Philip Freneau, the poet of the Revolution:

"See how she mounts the foaming wave,
Where other ships would find a grave;
Majestic, awful and serene,
She walks the ocean like its queen."

Father of the American Navy — John Barry

Barry's command of the "Alliance" continued until the close of the war, and he was devotedly attached to her. She enjoyed the unusual distinction of being the only frigate to escape capture or destruction, was in many important engagements, always coming off victorious, and was the fastest sailer in the navy. She bore across the seas Colonel John Laurens when he went to France for funds to move the French army from Rhode Island to Yorktown. On this voyage Barry gave our British cousins a lesson in international law, when, in the capture of a privateer of the enemy, he at once released a Venetian ship taken by the privateer. He held the capture to be contrary to the law of nations, which respects the property of neutrals. For this he was thanked by a resolution of Congress. Franklin wrote of it in a letter from Paris on November 5th, 1781, to the President of Congress: "The Ambassador of Venice told me that he was charged by the Senate to express to me their grateful sense of the friendly behavior of Captain Barry, commander of the 'Alliance,' in rescuing one of the ships of their state from an English privateer and setting her at liberty."

The next brilliant performance of our hero was the capture, in April, 1781, of two English brigs, the "Mars" and "Minerva," after subduing a mutiny on his vessel that seriously impaired his fighting force. A month later he fought and captured the armed ship, the "Atalanta," and the brig "Trepassy," in a memorable engagement. Barry was wounded in the shoulder by a grape-shot, and from loss of blood was compelled to go below. The colors of the "Alliance" had been shot away, the rigging was badly cut and the ship was greatly damaged. The first officer, feeling that all was lost, went to Barry to ask leave to surrender. Barry's answer was a defiant "No" and an order to be brought on deck, where he soon had the happy satisfaction of seeing the enemy lower

their colors. Frost's "Naval Biography" says of this engagement: "It was considered a most brilliant exploit and an unequivocal evidence of the unconquerable firmness and intrepidity of the victor." It induced William Collins to ride his Pegasus in this martial fashion:

"In the brave old ship 'Alliance,'
We sailed from sea to sea;
Our proud flag in defiance
Still floating fair and free;
We met the foe and beat him,
As we often did before;
And ne'er afraid to meet him
Was our brave old Commodore."

In 1781 the entire navy of the United States consisted of the "Alliance" and the "Deane," and Barry was placed in command of this squadron of two by Robert Morris, Supervisor of Finances, the Admiralty and Naval Boards having been abolished. It will be thus seen that from seventh in rank he had arrived at the top of the list. He was chosen for the important work of transporting Lafayette to France after the battle of Yorktown, a mission to which Washington attached the highest importance, and out of which came influences that hastened the ending of the war. A warm friendship was established between Barry and Lafayette, as may be seen by Barry's letter to the great Frenchman on November 17, 1782, wherein he writes: "You say you are going to America. I envy the captain who is to take you. I wish I was in his place, but, although I am deprived of that happiness at present, I hope to have the pleasure to command the ship that conveys you to your native country."

Peace between the United States and England was agreed upon on February 3, 1783, while Barry was at sea on the "Alliance." He had sailed from Havana on March 7, accompanied by the Continental ship "Luzerne," the two vessels having on board about \$200,000 of specie for Congress. Three days later they fell in with three British frigates, two of which Barry engaged and beat off.

First Commander of First Vessel in First Fight

One of these was the "Sybille," which was silenced after the "Alliance" lost eleven men. This was the last naval battle of the war, and it was fitting that it should be fought by the nation's greatest sea warrior. Of this battle, a good story is extant, which, however, has no authority to support it. It was said that Barry, when hailed on this occasion by the enemy, answered: "The United States ship 'Alliance,' saucy Jack Barry—half Irishman, half Yankee—who are you?" From what we know of Barry's modesty, the note of bombast in this greeting is somewhat jarring. But perhaps it is not well to examine historical yarns of this type closely.

When the war was ended, Barry joined the merchant service, and he does not again become a national figure until on March 19, 1794, we find him offering his services to President Washington to command the squadron against the Algerines, those Corsairs of the African coast having caused much havoc to the commerce of the United States. From this grew the present American Navy. The records of the War Department of June 5, 1794, show that Washington appointed Barry as the ranking commander of the new naval armament ordered to be built by Congress. The commission was signed by Washington on his birthday, on February 22, 1797, and is marked "No. One." The appointment was well received in the country. Cooper's "History of the Navy" says: "Captain Barry was the only one of the six surviving Captains of the Revolutionary War who was not born in America, but he had passed nearly all his life in it, and was thoroughly identified with his adopted countrymen in interest and feeling. He had often distinguished himself during the Revolution, and, perhaps, of all the naval captains that remained, he was the one who possessed a greater reputation for experience, conduct and skill. His appointment met with general approbation, nor did anything ever occur to

give the government reason to regret its selection."

Barry's first task at the head of the young navy was the superintending of the building of the frigate, the "United States," the first vessel of the present navy, which was launched in Philadelphia on May 10, 1797, amid great popular rejoicing. Miss Eleanor Donnelly's spirited poem, commemorative of the occasion, thus begins:

"A May-day sun—a noon-day tide—
And a warm west wind for the ladies fair!
A hundred craft at anchor ride,
Their bright flags gemming the Delaware.

"Ten thousand freemen crowd the quay,
The housetops other thousands hold;
All Philadelphia throngs to see
The launch of Barry's frigate bold.

"The gallant ship, 'United States,'
First of our navy's valiant fleet—
A nation's fame on her future waits,
A nation's hopes in her present meet."

Two noted American seamen began their careers with Barry on the "United States:" Stephen Decatur, who was to become famous in the War with Tripoli and with Great Britain, and Charles Stewart, the grandfather of Charles Stewart Parnell. Service under Barry was eagerly sought, as, while a strict disciplinarian, he was eminently just and considerate. It was Barry who, in a letter of January 8, 1798, suggested the creation of a navy department, and also that navy yards should be located for ships and supplies. The organization of the navy into a separate department followed three months later. In the difficulties that arose with France, and in command of the American fleet in the West Indies, he served with distinction. When peace came in 1801, Barry was retained in the service. The remainder of his life-story may be briefly summed up. His health, broken by his many arduous campaigns, began to fail, and at his country seat, at Strawberry Hill, near Philadelphia, he gently drifted into the Valley of the Shadow. He died on September 13, 1803. In its notice of his death, the *Pennsylvania Ga-*

Father of the American Navy — John Barry

zette thus feelingly refers to his life and services: "His naval achievements would of themselves have reflected much honor on his memory, but those could not have endeared it to his fellow-citizens had he wanted those gentle and amiable virtues which embellish the gentlemen and ennoble the soldier." He had been twice married, but, like Washington, was childless. It has been beautifully said of Washington that under the Divine plan he was to be childless that a nation might call him Father. May not in a lesser degree the same sentiment hold good for the Father of the American Navy?

The record of this remarkable man will not be found in the recognized histories of the Revolutionary period. The friend of Washington and Lafayette, who was twice thanked by Congress, who was in command of the Continental sea forces when Cornwallis surrendered, who suggested the creation of the Navy Department and held its first commission, seems to have been strangely ignored. Vainly is Bancroft and McMaster searched for some light on his career. The newer histories of Higginson, Wilson and Garner and Lodge make no allusion to him. Larned's "History for Ready Reference" omits him. Winsor's "Narrative and Critical History of America" simply alludes to Barry's loss of the "Raleigh" without comment. It remained for Martin I. J. Griffin, of Philadelphia, a painstaking and faithful historian, to dig into the records of a century or more ago and bring to light the salient facts in the life of this great sea captain. From his book, "Commodore John Barry," printed by subscription a few years ago, were obtained the data for this paper. The book is a valuable contribution to the history of the country, which has so long permitted one of its truest heroes to remain in comparative obscurity. An instalment of justice was obtained four years ago, when the torpedo boat destroyer "Barry" was launched, and the wrong

of a century will be partially righted if Congress passes the bill now pending in the House appropriating \$25,000 to erect in Washington a monument inscribed: "John Barry, the Father of the American Navy."

He sleeps the dreamless sleep of the dead in old St. Mary's Cemetery, on Fourth street, above Spruce street, Philadelphia, near to the lordly waters of the Delaware that had borne him so often to and from the sea. Until 1876 no marble shaft reared its height to heaven to recall his life and services, but in that Centennial year the Catholic Total Abstinence Union of America placed his statue on their fountain in Fairmount Park, at the foot of George's Hill. That same year his grave in St. Mary's Cemetery was marked by his friends and fellow churchmen with a tomb, the inscription on which was composed in part by his friend, Dr. Benjamin Rush, one of the signers of the Declaration of Independence. This brief sketch of the life of a great and good man may fitly end with an extract from the message on the sculptured marble:

"Sacred to the memory of
COMMODORE JOHN BARRY,

Father of the American Navy.

Let the Christian, Patriot and Soldier
who visits these mansions of the
dead view this monument with
respect and veneration.

Beneath it rest the remains of JOHN
BARRY, who was born in County
Wexford, Ireland, in the year 1745.
America was the object of his patriot-
ism and the aim of his useful-
ness and ambition.

At the beginning of the Revolutionary
War he held the commission of
Captain in the then limited
Navy of the Colonies.

His achievements in battle and his re-
nowned naval tactics merited for him
the position of Commodore, and to be
justly regarded as the father of the
American navy.

He fought often and bled in the cause
of freedom, but his deeds of valor
did not diminish in him the vir-
tues which adorn his private life.

He was eminently gentle, kind, just
and charitable, and no less beloved
by his family and friends than
by his grateful country."

The Rise of a New Surgical Science

Evolution of a
Personal Adornment into
the Self-protection of the Human Race *
Uplift of a Mental Trade to a Great American Profession
which now bears the "Hall Mark" of Culture and has become a
part of the American Educational System * The Birth of Dental Surgery

BY

DR. JAMES MCMANUS

AUTHOR OF A TREATISE ON "HISTORY OF ANESTHESIA" AND A
DEAN OF AMERICAN DENTISTRY

THE evolution of a new surgical science that has become an important element in the uplift of the human race is here told. Not many years ago this science was considered foppery and was repudiated by American educators. Today it stands as one of the great American professions and is accepted as a "hall mark" of culture. It is one of those interesting instances where personal adornment has led to self-protection and even longevity.

Not until the present generation has medical science and education acknowledged dentistry. The Maryland University, in 1839, refused to add a dental department to its medical school on the ground that "dentistry is of no consequence." Twenty-seven years later, in 1866, Yale College considered the project unfavorable, and a year later Harvard gave it position. That was forty years ago. Now, in 1907, there are twenty-one independent dental colleges; ten dental departments connected with medical colleges and twenty dental departments connected with universities throughout the United States. From these fifty-one institutions in the past sixty-seven years there has been graduated probably over twenty-five thousand doctors of dental surgery. The record tells of how "much consequence" civilized people consider dentistry to-day.

America has led the world in surgical surprises and the marvelous operations by surgeons all over the world have been made possible only by the discovery and demonstration of the "Mastery of Pain" by Horace Wells, whose "anæsthesia" has been possibly the most practical blessing bestowed on mankind.

The American people cannot forget to pay honor to the memory of their benefactors and those who have given valuable service to the country or to the cause of science.

Dr. McManus here contributes to American historical records his researches into the development of this surgical science of dentistry. There is no authority in America more capable of presenting the subject. He is not only a thorough scholar, but his services to the profession and its elevation as a science have been recognized throughout the United States and Europe. His lectures in this country and abroad have been important factors in the development of dental surgery.

This article is of especial interest in connection with the story of "The First Physicians in America" by Dr. Steiner in the second number of this first volume of THE JOURNAL OF AMERICAN HISTORY. It is the intent of these pages to record from time to time just such articles of practical value to the public-at-large, told entertainingly, and showing the beginnings of the works of mankind.

The Evolution of a New Surgical Science

MANY years ago, when I was young and credulous, I listened with great interest and pleasure to Wendell Phillips deliver his celebrated lecture on the "Lost Arts." He told of many things as facts that I could readily believe, but when he stated that gold fillings had been found in the teeth of mummies over three thousand years old, the germ of doubt found lodgment and my faith and belief in the eloquent orator weakened.

In a paper before the American Dental Society of Europe at Geneva, Switzerland, in 1905, by Dr. W. J. Younger, formerly of California, now of Paris, France, he told of his making a study of mummies in the museum of Cairo, Egypt, under the supervision and intelligent assistance of the doctor in charge, G. Elliott Smith, and after critical examination of many subjects, some dating seven thousand years B.C., in none did they find any trace of dental art. We have, however, evidence that gold leaf was used by Italian dentists previous to 1450, as stated by Giovanni de Arcoli in a work on medicine that he published in 1450 in which were several chapters on dental medicine.

Ancient Origin of Surgical Science of Dentistry in 1850

While it is believed that dentistry had its origin in ancient Egypt, coming down through Greece, Italy, Germany, France and England, and, while some of the medical writers of those countries as early as the thirteenth century gave some attention to the teeth, it was not until 1700 in France that one desiring to pass examination before an examining board, and in 1728 Pierre Fauchard, a dentist in Paris, after many years' practice, published a work on dentistry which to-day is held in high estimation for its advanced and valuable teachings.

The student of early history can

find little information in the records as to the methods of treating the mouth. Substitutes for lost teeth were worn by the wealthy. The pieces of fine gold metal work to hold such in place in the mouth that may be seen in several of the museums of Europe prove conclusively that there were artisans in the dental prosthetic line several hundred years before the Christian era.

To-day the science is known as the "American profession." It is distinctively a development of American culture, and yet it was but a few years ago that educational institutions in America refused to acknowledge it as a science. In 1866, when Dr. Asa Hill of Norwalk petitioned the medical faculty and corporation of Yale for the addition of a dental department there was opposition among the scholars. The Maryland University in 1839 refused to add to its medical school a dental department on the ground that "dentistry was of no consequence," and the faculty and corporation of Yale College when asked to add a dental department, twenty-seven years later, refused.

First Medical School in America to Recognize Dentistry was Harvard

Harvard University was asked later that year, and a quick response was given and a dental school was established there in 1867. In 1907, there are twenty-one independent dental colleges; ten dental departments connected with medical colleges and twenty dental departments connected with universities throughout the United States. From these fifty-one institutions in the past sixty-seven years there has been graduated probably over twenty-five thousand doctors of dental surgery. The record tells of how "much consequence" civilized people consider dentistry, and how much they value and appreciate the services of educated and skilful surgeons.

It is within the past one hundred years that surgery and surgeons have

An Element in Uplift of the Human Race

commanded respect and professional rank, as the early records tell that surgeons were generally held in contempt and operations given over to barbers or "Menial Servants" of physicians to be performed under their direction. The surgeons were just tolerated at the time when their services were in demand, but of little importance after the operations were performed. As many of the minor operations, such as bleeding, cupping, dressing wounds and extracting teeth fell to the care of the barbers, they were incorporated into a common company with the surgeons in London in 1308, but the name or title Surgeon Dentist was not known until 1622.

First Dentists in America were at New York and Boston in 1766-68

The first qualified dentist on record in the United States was an Englishman named Robert Woffendale, who practiced in New York in 1766. There was a Mr. John Baker in Boston in 1768, who had as a pupil that Boston celebrity and patriot of revolutionary fame, Paul Revere, who, it would seem, was "Jack-at-all-Trades." During the War of the Revolution there came, with the French soldiers under the Count de Rochambeau, a young officer named Joseph Lemaire, who, previous to his joining the Army, had been a practicing dentist in Paris. While the French and American soldiers were in winter quarters near Providence, Rhode Island, in 1781-84, Lemaire gave his services to the officers and others who were in need of dental operations and also gave instructions in dentistry to Josiah Flagg, the first native American to take up dentistry exclusively for a business. There was also with the French fleet, a surgeon by the name of James Gardette, who had, as required by the French service, received instruction in dentistry. He later resigned from the service and located in Philadelphia where

he practiced dentistry for forty-five years.

From 1790, and for years following, many men handy with tools and sufficient assurance to offer their services were classed as dentists. The "Hall Mark" of ability and respectability was conferred on John Greenwood of New York city by President Washington, who wrote to him from Mount Vernon, New York, in 1795, saying: "I shall always prefer your services to those of any other in the line of your present profession."

First Skilled Foreign

Dentists in Philadelphia in 1803

The dentist whom tradition holds in highest esteem as an educated, cultivated, skilful dental practitioner is the Irishman, Edward Hudson, who practiced in Philadelphia from 1803 for many years. The Army and Navy standing of the Frenchmen, Lemaire and Gardette, and the experience of the Irishman, Hudson, in the office of his uncle, a dentist of reputation in Dublin, Ireland, with the social and educational advantages they possessed, enabled these foreigners to offer assurances to the public that they would give intelligent and competent service. Their success was an object-lesson and they opened up a new and attractive field for Americans to enter. Previous to 1840, there were a few graduates in medicine who turned their attention successfully to dental work, but for twenty years later to 1860 the large majority were men who had been employed in some kind of mechanical work, such as wood and ivory workers, tool-makers, engravers and jewelers; and the transition from bench-work to office workers was often quickly effected by giving a few weeks' time in looking on, and practicing in the office of a dentist who had attained reputation and success on as little previous preparation. There were few text-books; the French and German works were not then translated and the few English books were expensive and not in

The Evolution of a New Surgical Science

the American market. Dentistry then was in this country a possible artistic trade, and those following it could expect no more cordial recognition from the medical men than the surgeons received fifty years earlier.

Among the few, early in 1800, who chose dentistry as their calling after spending years in other and varied avocations, was a man named Horace H. Hayden, who was born in Windsor, Connecticut, October 13, 1769. His name and fame as the Father of American Professional Dentistry is known not only in the United States but is universally acknowledged in all civilized countries.

William Hayden is mentioned in colonial history as early as 1630, and in 1637, his name as a soldier is specially mentioned for bravery in the report of Captain John Mason, whose life he saved in the Pequot War. William Hayden bought and secured land from the Colony of Connecticut for military services in the Pequot War and settled in the valley of Windsor in 1642. His eldest son, Daniel, was a lieutenant in the Colonial Service and an influential member of the General Court, and his eldest son was also a member of the General Court. The third Daniel was a lieutenant in the French and Indian War, and was considered a rich man. The third lieutenant, Daniel Hayden's eldest son, Thomas Hayden, was the father of Dr. Horace H. Hayden. The Revolutionary War Record of Thomas Hayden reads as Sergeant in the Army at the alarm at Lexington in 1775 and later as Sergeant Major, Second Lieutenant and Adjutant in the Revolutionary War until 1783. Previous to his military service his business was an architect and builder, which he resumed after the close of the war. The wife of Thomas Hayden, Abigail Parsons, had an ancestral record, equally honorable as a descendant from families noted for their intellectual and scholarly attainments.

Father of Professional Dentistry in America

Horace H. Hayden was born in ancient Windsor, October 13, 1769, with the Hayden inheritance, and a mother's record, as descendant of one of the brainiest families in New England; the legend may well be accepted that the boy learned to read as soon as he could talk; that he early loved to tramp in the woods; his later botanical and geological writings and the first book published on geology in the country, written by him, and his discovery of a mineral which was named "Haydenite" after him, proved that his love of nature studies was an early development.

At fourteen years of age he made two trips on a brig, working his passage to the West Indies. On his return, he went to school until he was sixteen, when he learned the trade of a carpenter of his father and later studied architecture. At twenty-one he sailed again to the West Indies, but his stay was short on account of an attack of fever, returning the next year and again forced home on account of the unhealthy condition of the island. For several years he continued his studies in architecture and at twenty-four years of age he went to New York, remaining a few months, but not meeting with success he returned to his home and taught school one winter near Hartford. His ability as a teacher was recognized and he was advised to follow that calling, but while on a visit to New York he called for dental work on a Mr. John Greenwood, President Washington's favorite dentist, and, while under his care, he became so much interested in the man, his methods and his skill, that he decided that he would like to be a dentist.

The manual ability acquired, as a boy and man, in the different lines of work he had followed, his studies, travels, and the few months' experience as a school teacher, well fitted him to take up the study and practice of

An Element in Uplift of the Human Race

dentistry, with, it is told, only one or two books and pamphlets on dentistry, a few instruments, such as he could procure, depending on the instruction that Greenwood was able to give him, in the short time he was with him, with little money and no friends, he opened an office in Baltimore, Maryland, in 1800. While he was fairly successful from the start, he wasted no time but took up the study of medicine and surgery, and by his zeal in his studies and close attention to his business, he soon gained the confidence of the public and the esteem of many of the medical profession. When the British attacked Baltimore in 1814, Hayden's military inheritance broke out, and he enlisted as a sergeant; but, as medical men and surgeons were in demand, General Smith, who knew his skill, assigned him to an hospital, as an assistant surgeon, where he remained as long as the sick and wounded needed his care. To his dental and medical studies he added the studies of botany and geology and, in 1810, published a geological sketch of Baltimore. It was near that city that he discovered a form of "Chabazite" to which Professor Silliman gave the name "Haydenite." Dr. Hayden, early in his practice, felt the need of, and realized in part what might be gained, if dentists were to meet frequently in convention. After years of thought he started a movement in 1817 to call in convention the leading dentists of the country. The effort was unsuccessful.

First Book on Geology in America Written by Dentist in 1812

The great interest taken to-day, by professional men, in post graduate schools, and the great benefit they, as well as the country, gained by these meetings, tell how far-seeing and educational were the aims and ideas of Dr. Hayden as early as 1817. His love for the study of geology and the difficulty of finding works on the subject in English forced him to learn to read and translate French, as the best

works on the subject were in that language, and in 1812 he published a volume of four hundred pages entitled "Geological Essays," the first work on that subject published in the United States. He had for the time a valuable collection of American minerals, which are now a part of the collection of Roanoke College, Virginia. His reputation as a dentist and a student, his fame as a professional and scientific writer and his success as a teacher gained for him the compliment, the first of the kind ever paid to a dentist, of an invitation to give a course of lectures on dentistry before the Medical Class in the University of Maryland in 1825, and in 1837 the honorary medical degree was conferred on him by both the University of Maryland and the Jefferson Medical School of Philadelphia. From 1817, when the effort made by Dr. Hayden to organize a dental society failed, until 1840, dental progress was of the individual go-as-you-please order.

First Dental Society in America Organized in New York in 1840

Dr. Hayden's many years of daily office work, and his habits of study had convinced him that dentistry meant more than how to fill teeth and make artificial ones; and, that one attempting to practice dentistry should have a knowledge of medicine. With settled belief that through associated efforts great good would speedily result, he again invited a few of the leading dentists of the country to meet in New York City, August 18, 1840, when the American Society of Dental Surgeons was organized. Dr. Hayden was then elected president, continuing in that office four years, until his death. Many scientific men from all the states in the West and South soon became interested in the new organization.

The first serious public movement made towards elevating the calling of dentistry, quickly led to the project of publishing a journal. The

The Evolution of a New Surgical Science

Dental, Medical, Scientific and other papers, written by Drs. Hayden, Harris, Hudson and many others in the country, were at the mercy of the medical publishers, and at the second meeting of the society, it was decided to institute a journal, the first devoted to dentistry ever published, to be known as the *American Journal of Dental Science*, and Dr. Hayden was a frequent contributor to this journal.

The last, and without doubt, most important step was the establishing of a school for dental instruction. From the early years of his practice, Dr. Hayden felt the need of a properly equipped dental school, and with his friends, both dental and medical, it was a subject frequently talked over, with the hope of inspiring them with the high professional ideas that college instruction should foster. One of Dr. Hayden's former students named Chapin A. Harris, was not only an enthusiastic admirer but was in full sympathy with his ideas. As to the necessity for an advanced system of dental education, as also an energetic, practical, intelligent worker, they both had presented their views and hopes to men connected with the Maryland University, and urged the advisability of their adding a dental department to the Medical School. The faculty, like others of later years, were blind to their best interests, and gave as an excuse for rejecting the proposition "that dentistry was of no consequence." This refusal forced them to think of organizing an independent dental school, and, acting on the advice of Dr. Hayden, the work preparatory to applying to the Legislature for a charter, was mainly done by Dr. Harris. He was successful in getting influential citizens to favor the movement, and February 1, 1840, the Maryland Legislature granted a charter incorporating the Baltimore College of Dental Surgery.

First Dental College in the World Instituted at Baltimore in 1840

In the Articles of Incorporation,

section two, were appointed and constituted as professors of said college Horace H. Hayden, M.D., to be professor of Dental Pathology and Physiology; Chapin A. Harris, M.D., to be professor of Practical Dentistry; Thomas E. Bond, junior, M.D., to be professor of Special Dental Pathology and Therapeutics, and H. Willis Baxter, M.D., to be professor of Special Dental Anatomy and Physiology. A meeting of the faculty was held in the house of Dr. H. H. Hayden, February 3, 1840, and H. H. Hayden, M.D., was elected president and Chapin A. Harris, M.D., was elected dean. The long wished for dental college was incorporated, a faculty appointed and ready to receive students. At the second faculty meeting arrangements were made to advertise in several of the leading newspapers of the country and in the *American Journal of Dental Science* and the *Maryland Medical and Surgical Journal*. The first annual announcement stated that the desire of the faculty was to offer to students a course of instruction in theoretical and practical dentistry, and told of the advantages the college already possessed in the cabinet of anatomical and physiological specimens of Professor Baxter and the valuable pathological specimens collected during many years of extensive practice by Professor Hayden. The college opened its first course in the winter of 1840 and 1841 with five students. A small room in a good locality was temporarily engaged for a lecture hall, but for the teaching of anatomy and dissection a private and secluded stable loft was deemed the most prudent quarters for the student to occupy.

From the introductory lecture to the students and friends, delivered November 3, 1840, by Professor Chapin A. Harris, a few quotations will be of interest: "Accessible as has been the calling of the dentist to all that were disposed to engage in it, and that, too, without regard to qualification, it has been resorted to by the ignorant and

An Element in Uplift of the Human Race

illiterate and I am sorry to say, in too many instances, by unprincipled individuals until it now numbers in the United States about twelve hundred, and of which I think it may be safely asserted that not more than one-sixth possess any just claims to a correct or thorough knowledge of the pursuit,—a little mechanical tact or dexterity is thought by some to be all that is requisite to a practitioner of dental surgery, and that this could be obtained in, at most, a few weeks,—elevate the standard of the qualifications of the dental surgeon to a level with those of a medical practitioner, and the results of his practice will be always beneficial, which at present are frequently the reverse. Require of the practitioner of dental surgery to be educated in the collateral sciences of anatomical and physiological surgery, pathology and therapeutics and the sphere of his usefulness and his respectability will be increased,—aware of the responsibility that rests upon them; the faculty will spare no efforts to make it creditable to the state that created it and beneficial to the public,—in short, they are determined that no reproach shall rest upon them for fixing a standard of qualification that shall not at once be respectable, and entitle those coming up to it to the confidence of an enlightened community.”

Dr. Harris, in his introductory lecture to students, tells “that in 1840, there were twelve hundred dentists in this country, and not over two hundred of them possessed any just claim to correct or thorough knowledge of the calling they pursued.” The aim of the professor of the Baltimore Dental College was to teach students scientific and practical dentistry. At the first commencement exercises in the Assembly Hall, Baltimore, March 9, 1841, Professor Bond in his valedictory address tells the friends and students gathered there what has been taught to them during the course of instruction, and what they ought, or were believed to know. “You have

been taught that dental surgery is not a mere art, separate from, and independent of general medicine, but that it is an important branch of the science of cure. Your knowledge has been based on extensive and accurate anatomical investigation. You have seen and traced out the exquisitely beautiful machinery, by which the organism is everywhere knit together. You have learned the secrets of nervous communication and studied the simple, yet admirable, arrangements by which nutrition is drawn by each part from the common receptacle of strength. You have also carefully examined the phenomena of health and disease, as they are manifested in the dental arch, its connections and relations. Your attention has been particularly directed to the effect of irritation on the general health, and you have seen how readily organs apparently unconnected and independent may be involved in mutual disease. You have been taught to regard the human body as a complete whole, united in all its parts and pervaded everywhere by strong and active sympathies, and your principles of practice have been carefully formed on a sound knowledge of general medicine.”

First Degree Granted by the Legislature of Maryland

This instruction from November 3, 1840, to the day of the valedictory address by Professor Bond at the commencement exercises and the conferring of the degree of Doctor of Dental Surgery upon two students who had passed a satisfactory examination, Robert Arthur and R. Covington Mackall, by the president of the college, Horace H. Hayden, M.D., incidentally proclaimed to the world that the trade or calling of dentistry had, by virtue of an act of incorporation granted by the Legislature of the State of Maryland, been changed to the profession of dentistry and admitted to the rank with the learned professions. One of the provisions of the charter allowed the conferring of

The Evolution of a New Surgical Science

the honorary degree on any dentist who had distinguished himself in his profession. Any reputable dentist, who had not obtained an honorary degree, could apply for an examination and if, after the presentation of a thesis, showing specimens of mechanical work and demonstrating his ability to operate skilfully in the mouth, he could pass a satisfactory oral examination before each member of the faculty, the degree of Doctor of Dental Surgery might be conferred. During the early years of the college this power was judiciously exercised for the records of the college show that not all who applied were successful in gaining the coveted degree; after the first session the faculty conferred the honorary degree on a number of worthy dentists in this country, Canada, England, Scotland and France. There were two graduates the first year, three the second, and the third year, six. The fourth year the president, Dr. Hayden, died January 26, 1844, aged 75. The college that was "opposed by many, and a short life predicted," he lived to see firmly established and in charge of earnest men on the road to assured success. In 1846, a suitable building was secured that gave ample facilities for both theoretical and practical instruction and for the establishment of a dental infirmary and operating room. In 1846, Cyrenus O. Cone, M.D., D.D.S., was appointed professor of mechanical dentistry in the first dental college in the world.

Earliest Dental Colleges in Ohio, Kentucky, Missouri and Louisiana

The marked success of the Baltimore College led to the establishment of the Ohio Dental College, which was chartered in 1845 and commenced its sessions that year in the city of Cincinnati. Soon followed the establishment of dental colleges in Kentucky, New York, Pennsylvania, Missouri, Louisiana and Massachusetts. Harvard University in 1867 was the first to add a dental department to its Med-

ical School, and the Boston Dental College was established in 1868. The Baltimore Dental College commenced in 1840 with four professors, and in 1855 there were added five, making nine. Harvard University opened a dental school twenty-seven years later, 1867, with a teaching faculty of ten professors. The medical and dental schools then required students to attend two full courses of lectures before examination for graduation.

The courses of instruction were mainly alike, the dental having additional studies in metallurgy and mechanical and manipulative training in place of general surgery and obstetrics. In the lecture room students were taught the use of the microscope and dental histology, anatomy—human and comparative—physiology, pathology, therapeutics, materia medica, chemistry, anæsthesia, general and oral surgery, bacteriology and orthodentia. In the laboratory, metallurgy was scientifically and practically taught, with special reference to the working of lead, zinc, tin, silver, gold and platina; also vulcanite. The student was taught to make and artistically adjust artificial teeth, to make continuous gum work, make crowns, bridges and porcelain inlays. He was taught to treat and master cleft palate deformities, make and adjust splints for broken jaws and restore portions of the jaws when lost, either by accident or disease. These include the scientific, artistic, mechanical and practical teaching that is given by the professors and demonstrators in dental colleges.

In the first twenty-five years of the nineteenth century there were twelve books published by American authors on dental subjects. A "System of Dental Surgery" was published by Samuel Sheldon Fitch, M.D., surgeon dentist, New York, 1829. This work was not claimed by its author to be more than an extended compilation. "Dentalogia," a poem on diseases of the teeth and their proper remedies, in five cantos, was published

An Element in Uplift of the Human Race

by Solyman Brown, A.M., New York, 1835, and another poem, "Dental Hygeia," 1838. The year the Baltimore College was organized, Chapin A. Harris, M.D., surgeon dentist, Baltimore, 1839, published "The Dental Art," a practical treatise on dental surgery. This was the first entirely original work published in this country for the use of the profession exclusively. In 1845, a second edition, enlarged and revised, appeared under the title of "The Principles and Practice of Dental Surgery." This work was generally acknowledged to be the best practical treatise on dental surgery that had ever appeared in any language. There have been many editions of this work since and it still is a standard text-book in the dental colleges of the world.

More than a century and a quarter ago, human teeth were used to replace lost front teeth. An advertisement of M. Lemaire, dentist, in a Philadelphia paper, offering two guineas each for front teeth, tells that they were so used in 1784, and have been occasionally ever since. Those wanting a partial or full upper or lower set of teeth had to take what the dentist could best make for them, using either the teeth of cattle, sheep, or teeth carved from hippopotamus ivory or elephants' tusks, until about 1825, when porcelain teeth were introduced from France. The improvements over the French formula for making porcelain teeth by Americans were many. The most successful were those made by Samuel S. White, who opened a manufactory in Philadelphia, in 1844, for making porcelain teeth for dentists. That establishment has since grown to be the largest and most successful manufactory of artificial teeth in the world. Only the well-to-do could afford artificial teeth on gold, platinum or silver; cheaper metals had been experimented with and were failures. The poor had little show for looks or comfort until after the invention and introduction of vulcanite by Nelson Goodyear in

1851 and 1855, enabling dentists to make artistic and serviceable artificial teeth that are within the reach of the poor.

The Drs. Hayden, Harris, and all associated with them, were desirous that dental students should be given as good opportunities to acquire education as the student at medical colleges, and the standard in the colleges to-day are no higher than the one set by Professor Harris in his introductory lecture, and Professor Bond in his valedictory to the students in the Baltimore Dental College in 1841. Medical colleges send out graduates, as physicians and surgeons, and it is well known that a large majority never practice either general nor special surgery. Dental practitioners have to do daily more or less surgery and many have attained high rank in that most delicate, difficult and dangerous specialty, oral surgery. These are from choice—surgeon dentists and mechanical dentists. The degree of the medical and dental colleges alike confers on all graduates professional rank.

First Legislature to Regulate Practice of Dentistry was in Alabama

It is interesting to note that the Legislature of Alabama passed an act to regulate the practice of dentistry in 1841, the year the Baltimore Dental College held its first session. The gift of foresight surely impelled the few dentists of that state to be the first to procure by legislative enactment professional and legal standing for dentistry.

In the last half century nearly every commonwealth in the United States has contributed to the advancement of the new surgical science, but it is a curious historical fact that the progress emanated from New England and one of the smallest states in the Union was one of the largest, most liberal contributors to the profession. That the upward development of the calling of dentistry along scientific and pro-

The Evolution of a New Surgical Science

professional lines was largely the work of a clique of men, will be seen when the names are chronologically noted with the character of their work. Horace H. Hayden, M.D., born in Windsor, Connecticut, October 13, 1769, architect and builder, dentist, army surgeon, geologist, the organizer of the first dental college in the world, its first president and first professor of the principles and practice of dental science, a voluminous writer on dental and scientific subjects, was one of the organizers of the first dental society and the first dental journal of the world. Solyman Brown, A.M., D.D., M.D., D.D.S., born in Litchfield, Connecticut, November 17, 1790, a dental writer, dental poet, teacher, was first secretary of the first dental organization and one of the organizers of the first dental journal. Dr. J. Smith Dodge, born in Connecticut, 1806, writer, teacher, was one of the organizers of the first dental society. J. M. Riggs, born in Seymour, Connecticut, October 25, 1810, was a student with Dr. Horace Wells. On the eleventh of December, 1844, he extracted a tooth for Dr. Wells while he was under the influence of nitrous oxide gas administered by Professor G. Q. Colton. This was the first application of anæsthesia in surgery, antedating by nearly two years Dr. Morton's use of sulphuric ether. Dr. Riggs gave a clinic at Northampton, Massachusetts, in June, 1867, and also gave a description of his method of treating and operating for the conditions now known as Pyorrhœa Alveolaris, but which for a time was called by his name "Riggs's Disease." Dr. John S. Clark, born in Brooklyn, Connecticut, 1813, practiced for several years in St. Louis and in New Orleans. In that city, 1850, he published a magazine called "The Dental Obturator." Dr. Asa Hill, born in Norwalk, Connecticut, November 20, 1816, a man of fine literary attainments and a frequent contributor to the periodicals, and associate editor

of several dental journals, invented the valuable temporary filling material known as "Hill's Stopping." He was also a member of the Connecticut State Legislature, 1856. Dr. C. A. Kingsbury, born in East Windsor, Connecticut, 1819, writer, teacher, was for many years a professor of the Philadelphia Dental College. Cyrenus O. Cone, M.D., D.D.S., born in East Haddam, September 20, 1820, was pioneer professor of mechanical dentistry in the Baltimore Dental College.

First Manufacturers of Dental Instruments in America

Dr. Horace Wells, writer on dental subjects, was the discoverer and demonstrator of the anæsthetic properties of nitrous oxide or laughing gas, December 11, 1844. The first one to manufacture gold foil in this country was Marcus Bull of Hartford, Connecticut, in 1812. Levi Gilbert, a confectioner in New Haven, Connecticut, in 1848, obtained a patent for cavity plates, the first application of the principles of atmospheric pressure in dentistry—a most important part of mechanical dentistry. Nelson Goodyear of New Haven, Connecticut, in 1851 invented a process of making hard rubber or vulcanite, which has since been so successfully used for making artificial dentures, obturators, dental splints, and regulating appliances and in many and various ways has proved of great value to mankind.

The American profession is now established for all ages. It has become a notable element in civilization and a mark of culture. Great credit is due to the men who lifted it from an obscure and menial trade to a position of dignity and achievement, doing its part toward the higher uplift of the human race, and to the men who today are upholding its honor; that they, too, may contribute to the history of human endeavor for the good of man.

Centennial of the Savings Bank

One Hundred Years
Ago the Modern System
was First Outlined in the House of
Commons & Duke of Wellington remarked that if Men
had Money to Spare it was Time to Reduce their Pay & First
Savings Banks in America and their Marvelous Effect on Industry and Thrift

BY

HONORABLE NORMAN WHITE

MEMBER OF THE STATE LEGISLATURE OF MASSACHUSETTS
HOME OF THE FIRST AMERICAN SAVINGS BANK

THIS is the centennial year of the savings banks. In one hundred years a system has been built up that throughout the world is notable for stability and conservatism.

The Duke of Wellington once said when somebody proposed a savings bank plan for the British Army that if Tommy Atkins had money to spare it was time to reduce his pay. But that was not the sentiment of advanced people of his day. The beginnings of the savings banks is a story of humanitarian efforts. Reverend Joseph Smith, in 1798, with the support of two wealthy parishioners at Wendover, started a system of receiving from members of his congregation any sum from twopence up, to be returned at Christmas with one-third of the whole added as interest. Mrs. Priscilla Wakefield started in 1799, her famous scheme for the benefit of women and children in the village of Tottenham, which was afterward regularly organized under the name of the Charitable Bank.

Just 100 years ago this winter, the whole plan of the modern savings bank was outlined in a speech in the House of Commons by a Mr. Whitbread. His clear-sighted formulation began the system of which we know.

America was not far behind England in the development of the beneficent scheme. If 1907 marks the one hundredth anniversary of modern

savings, it is also the ninetieth anniversary of the opening for business of the earliest American savings bank. The Provident Institution for Savings, Boston, was incorporated December 13, 1816, and began to receive accounts a few weeks later.

From then on one finds an interesting story of the devotion and self-sacrifice by busy Americans, who have voluntarily taken charge of funds which they have, save in the most exceptional instances, regarded as a trust rather than as an investment. In one of the first advertisements of the Provident Institution for Savings it is stated: "The trustees will take no emolument or pay for their services, having undertaken solely to promote the interest of the city and of the persons above described who may put their money therein." That has been the prevailing spirit in savings bank management down to this day.

After the immediate success of the Provident was assured numerous other institutions of the same kind were started in New England. Most of these have continued in their honorable career down to this time. Among those that soonest opened their doors to depositors were: Institution for Savings in the town of Portland and vicinity, 1819, not organized; Savings Bank of Newport, Rhode Island, 1819; Providence, Rhode Island, Institution for Savings, 1819; Society for Savings, Hartford, Connecticut, 1819; Institution for

Its Moral Effect on American Citizenship

Savings in Newburyport, 1820; Portsmouth, New Hampshire, Savings Bank, 1823; Institution for Savings in Roxbury, 1825; New Bedford Institution for Savings, 1825; Lynn Institution for Savings, 1826; Provident Institution for Savings in Taunton, 1827; Springfield Institution for Savings, 1827; Institution for Savings in Haverhill, 1828; Worcester County Institution for Savings, 1828; Provident Institution for Savings, Salisbury and Amesbury, 1828; Fall River Institution for Savings, 1828; Plymouth Institution for Savings, 1829; Provident Institution for Savings, Gloucester, 1831; Institution for Savings, Fairhaven, 1832; Windham, Vermont, Provident Institution for Savings, 1846.

An ingenious example of the advertising of the early nineteenth century is to be found in a little drama, a copy of which is one of the treasures of the Boston Public Library, called "The Brothers, or Consequences; A Story of What Happens Every Day." It was designed, as the name indicates, to be acted in the Village Lyceum or Town Hall. By showing what happened to the family of the unthrifty brother it was supposed to induce people to make regular deposits with the Provident Institution for Savings.

With the safeguarding exercised by the law, and the personal devotion displayed by trustees who receive no compensation for their services, no department of modern finance has been freer from suspicion or reproach. Even in the early decades of the nineteenth century the savings banks were noted for their safe and conservative management. Savings banks, while needing supervision, have never had to be drastically reformed.

Some of the banks were hard hit by the panic of 1837-8, but as an institution they had become firmly established. Along about 1850 most of the "five cent savings banks," which are now a feature in nearly every American municipality, were organized. The idea of so low a min-

imum was to induce minors to start deposits which would grow later.

The first hundred years of the savings bank has made it a mighty factor in civilization. Through it the labors of mankind have garnered the harvest until in every enlightened nation to-day savings banks are the greatest arbiters of industry.

The first century of the savings bank finds more than eight millions of the American people with nearly four billions of dollars safely guarded in these institutions. New York, last year, brought seventy millions to the savings banks, which is alone "greater than the total savings in the banks of Japan or Canada and almost as much as the total of rich Holland."

On this centennial it is interesting to observe that the savings in New York are more than one-third of those of the entire United States—more than those of thrifty New England, with Pennsylvania added; more than those of any nation and even the German empire cannot double the deposits of one American commonwealth.

In reflecting on the significance of this anniversary an observer remarks that the savings banks deposits of New York overtop those of all France by \$500,000,000; those of Great Britain by \$360,000,000. These deposits are \$514 for each depositor and \$170 for each inhabitant of the state. No other state in the Union equals the latter proportions, only California and Rhode Island reach the former. The German average deposit is \$150, the average for each German inhabitant is forty dollars. Denmark, Switzerland and New Zealand have the highest of the foreign savings bank deposits in proportion to population—respectively, seventy-eight, sixty-two, forty-nine dollars.

It is a wonderful story of progress and prosperity. Never before in human history has there been such astounding material advance, and through the savings bank, on this, its one hundredth birthday, pulsates the life-blood of industry and thrift.

Development of American Finance

*Its Moral Effect on American Citizenship & Liberty and
the Mighty Economic Problem & The Democracy of Nego-
tiable Securities & The Ten Commandments in Business*

BY

SERENO D. PRATT

EDITOR OF "THE WALL STREET JOURNAL"

WHEN this centennial of the financial system, through which the savings of the American people have been safeguarded, it is well to consider the outcome of this first epoch, viewing its moral effects on American citizenship. In speaking of America's amazing advance, an economist recently remarked: "Until we learn to think in billions we cannot measure the material development of the United States; much less can we mentally grasp the potentialities which the coming years have in store for us. Our progress, however, has only been the pioneering work of clearing the wilderness, of ploughing and planting amid the stumps which mark the new land of the settler. Not yet have we had time to pull the stumps

and drain the swamps. What we have been doing is like sowing by hand and gathering our harvest with the old sickle as compared with what we are now preparing to do." The material development of the United States is an impelling factor in the history of our growth as a Nation; from it will ultimately arise the age of Arts and Science. It is, therefore, critically essential that the integrity of American finance be protected and that demagogues be not allowed to undermine the faith of the American people in either labor or capital, the two elements on which the history of the future must be made. This, then, is an appropriate time and place to moralize on the modern economic problems, especially the moral principles that are involved in true American business development.

BANKS and stock exchanges were born at the very time when the world, shaking off the shackles of the old feudal system, leaped into the modern conception of liberty. With national wealth represented by ownership of land there was aristocracy. With national wealth represented by ownership of negotiable securities there is democracy. Dean Swift, writing at the time of the South Sea bubble, lamented the fact that owners of the land no longer had their old authority over the government. The commercial class, the bankers, the merchants, the speculators and promoters began to take the lead in the affairs of state.

The aristocracy of birth and land began to give way to the democracy of trade and the money market.

Thus the history of banks, corporations and stock exchanges which are the mightiest financial products of modern civilization, is closely allied to the growth of republican political institutions; and it is noteworthy that the two nations—England and the United States—where popular representative government is most advanced, have developed to the highest degree of efficiency the systems of credit and investment.

Is there anything more democratic in form at least than the stock corporation? Its ownership is represented by shares of stock that may be held by hundreds and in some cases are held

The Development of American Finance

by thousands of persons. These stockholders are like the citizens of a little republic. They vote—or have the right to vote—for a Board of Directors which is the congress of the republic. These directors elect a president who is the chief executive of the republic. The parallelism between the corporation and the form of our government is absolute. Those who attack our corporations are apt to overlook this fact. In attacking the corporation they are, in a measure, indicting the nature of the very government under which they live.

Banks and stock markets are important branches of the immense system of transportation by which the world is being unified, by which boundary lines and race distinctions are made to appear less vital and by which peace is promoted, trade internationalized, tyranny overthrown and liberty crowned. The stock market is the freest thing in the world to enter, though it may be costly to get out. It is a great leveller. It widens opportunity and gives the common man the same chance for development that formerly was monopolized by the landed aristocrat.

But as it has been an unending struggle to preserve our republican institutions, as our political history has been a record of contest with corruption, of battles against bosses who have attempted to seize the machinery of liberty to use it for tyranny and graft, so the history of corporations—these myriad republics of trade has become a record of struggle against financial bosses and financial graft. What the people of the United States are now trying to do is not to destroy the corporations. As well admit that republican government is a failure and go back to absolutism. What they are trying to do is to rescue the corporations for liberty and fair dealing.

It is important at this time to make this distinction. The great mass of the business men of the country are honest. The great majority of the

men in control of the corporations are honest. What has taken place has been an unconscious drift toward absolutism in the control of corporations. Stockholders who were indifferent to their rights, and directors who did not direct, have developed a class of financial bosses in this country. These bosses have been some of them constructive and some of them destructive, some builders of the nation, some violators of law, bribers of legislators, manipulators of the markets and monopolizers of the sources of supplies.

The mighty economic movement of to-day is a call to liberty. Its aim is to make the corporations democratic in fact as in form. Could any instrument be invented that is better adapted to secure a wide distribution of wealth than the stock company? Could anything better promote investment in securities by which that distribution is brought about than a free stock market? During the past eighteen years the New York Stock Exchange alone has listed over \$20,000,000,000 of stocks and bonds, and through the agency of its market these securities have been distributed among millions of investors. Could anything be more wholesome? Could anything contribute more to national strength and patriotism than the fact that the ownership of our banks, our railroads and our industries are widely distributed among the actual producers and wage earners of the country? This is the best kind of socialism, the only kind that will be permitted in this country, a socialism without confiscation, a socialism that does not overthrow the principles of individualism and the rights of property.

We are rapidly reaching toward a wider distribution of wealth. The next problem is to promote a greater democracy in the control of wealth. We want to dethrone financial bossism and establish financial leadership. We want to inspire greater vigilance

Its Moral Effect on American Citizenship

among stockholders. We want, above all, a higher sense of responsibility among trustees, for it is probably fair to estimate that at least one-half of the enormous wealth of the United States which has in this year reached the amazing total of \$115,000,000,000 is in the hands of trustees.

Probably few appreciate the service speculation has performed in this process of distributing the wealth of the country. But at the same time it has made possible the financial oligarchy reaching for the government of this wealth.

Speculation has its good and its bad side. It has a philosophic as well as a financial meaning. In philosophy it implies mental contemplation of data, examination of reasons and arguments. In finance it means the taking of greater or less risks. Both meanings may be and should be united in order to form any proper conception of the nature of stock speculation. To speculate is to take risks after an examination of all known fact. Such speculation is entirely legitimate and beneficent. Undoubtedly stock speculation enormously promotes the enterprise of the country. Those who decry Wall street as the American "Monte Carlo" and the stock exchange as a den of thieves, and regard the broker, to use a definition attributed to Dr. Samuel Johnson, as "a negotiator between two parties who contrives to cheat both," should pause for a moment and consider what this country would be without the stock exchange.

The facilities of credit and speculation have enabled the world, in two centuries, to accomplish the work of ten centuries. The stock market serves to mobilize capital, enabling it to be quickly massed for great enterprises, too large to be undertaken except by collective effort. It serves also to equalize prices, to prevent an over-supply at one time and a shortage at another. Conant says that the stock market is the great governor of

values, the determinant of the relationship between production and consumption, the guide which points the finger as to where capital is needed and where it has ceased to exist.

Even the room traders, apparently the most useless body of men in the world and who in a sense "toil not, neither do they spin," who produce no wealth, aid largely in the service which speculation performs for the country. These men, whose operations represent about one-third of the stock exchange transactions, simply trade on their own account and are in and out the market, it may be, a dozen times a day. They are at one moment bulls and the next bears. They are ever after the one-eighth or one-fourth profit to be made in the buying and selling of stocks on the floor. And yet these men who make speculation their constant business serve to maintain a constant market. It is the existence of these room traders that makes it possible at all times to establish quotations to affect sales and to have a place where you can always dispose of your securities at the price. Thus it is that even this class of speculators hold no inconsiderable a place in economics.

Moreover the same may be said of the whole body of margin operations, although a very small proportion of them can be considered as speculative in the highest sense. They enable the real financial builders oftentimes to perform their constructive work the easier in that the speculation facilitates the distribution of stocks.

Unquestionably a large proportion of the stock market transactions are gambling. At the bottom there is investment. Resting on this is a broader body of speculation, and above this, making a sort of inverted pyramid, is a great mass of gambling, that is to say, transactions which do not represent either investment for income or intelligent purchases for sale at profit, but more or less blind dependence upon chance.

The Development of American Finance

President Hadley of Yale University recently made an excellent distinction between the different kinds of speculation. "Much of the present-day speculation," he said, "is bad but side by side with the bad there is much that is good and indeed necessary. The first essential in right speculation is that a man must be really able to make good his guarantee as to the future. In other words, he must be risking his own money. If he is making contracts for future delivery on the basis of other people's money, whether through actual borrowings or through inflated credit, this is not trade but gambling with loaded dice."

W. R. Lawson, the English economist, in his latest work says that wherever there is business there must be speculation for the one grows out of the other, but legitimate trading rests upon a substantial basis of *bona fide business* while a stock gamble may be a mere fooling with market prices. He adds that the United States has had much experience of both these kinds of speculation. It has had its substantial El Dorados in the West and its fictitious El Dorados in New York, and he thinks that a safe guide of an American boom is the proportion of Western solidity there may be in it as compared with the Wall street gas.

The country is apt to think of Wall street as the richest place in the world. So it is from one point of view. But did you ever think of Wall street as the biggest borrower in the country? That is what it is, and the great mass of the transactions of the stock market are conducted on borrowed money. It is of interest to consider this point in connection with President Hadley's statement, that the first essential in right speculation is that a man must be risking his own, and not borrowed, money. The speculator puts up ten per cent of cash and borrows ninety per cent from his broker. The broker puts up ten per cent more

and borrows eighty per cent more from the banks. And the banks? Well, a great part of the money which they loan out on call to support the stock market is borrowed from the country banks for their deposits paid for by two per cent interest must be regarded substantially as borrowed money. In addition to the hundreds of millions of out-of-town deposits in the New York banks there is at this time between \$300,000,000 and \$400,000,000 of loans on call in the stock market made directly by banks and trust companies in the interior, and this makes a body of credit which is used almost exclusively for speculative purposes. The interest paid on the deposits of out-of-town banks and the direct loans made by out-of-town banks in Wall street constitute a real menace to the financial situation. If, then, speculation has become a national evil, it is largely due to the fact that the country itself is lending the money to the speculators to carry it on.

For reasons which I have already tried to indicate, it would be the height of folly to attempt to suppress speculation and close the stock exchange, but something might be done to keep speculation from overstepping the boundaries of moderation. If the line between gambling and legitimate speculation is the ability of the speculator to make good his guarantee as to the future, might it not be wise to apply this principle so as to reduce the volume of stock gambling and at the same time give ample opportunity for legitimate speculation? As a mere suggestion along this line would it not be well to increase the margin required in stock operation? If the broker would demand more margin from his customer and the bank more margin from the broker, the number of people who enter the stock market with insufficient capital would be immensely reduced and the security of stock operations immensely increased.

Its Moral Effect on American Citizenship

I have gone into this matter somewhat at length because it serves to emphasize the main point which I desire to make, namely, that all these great tools of modern business are capable of being used for mighty constructive enterprises and at the same time of being misused for immoral and destructive ends. In so far as they have failed of the highest achievements it is because, to use the recent language of President Schurman of Cornell University, "the moral nature of man has not developed as rapidly as his economic and financial capacities." In other words, we have failed in part at least to make a moral use of these mighty instruments of credit, of investment and of speculation. The most optimistic feature of the present day is the fact that we have awakened to this situation and are endeavoring to find out the ethical basis of business.

Let us test this whole matter by applying that simple but sublime code of morals—the ten commandments—to the business conditions of to-day.

You may remember Speaker Reed's cynical description of Theodore Roosevelt as a man who had "discovered the ten commandments." I do not pretend to have discovered the ten commandments, but perhaps I am entitled to the distinction of first putting them in double harness with the stock market. Take up the commandments one by one and see their economic significance:

"Thou shalt have none other gods but me."

It is time that we found out exactly where we stand on the question of religious faith. Accompanying the radical attack on wealth is a radical attack on the belief in God and the eternal life. All socialists are not atheists nor are all atheists socialists, but it is true that the radical type of socialist believes that it is essential to the establishment of his economic philosophy that God and marriage, re-

ligion and the home, should be legislated out of existence. Apart from this, moreover, there are many evidences, although I admit that they may be superficial, of a decline in the faith that lays hold on eternal life. This is a matter of most serious importance. I am speaking now not from the standpoint of religion but from that of business. If it be true that faith is declining then that means enormous economic readjustments. I can imagine nothing more deplorable, more destructive of values and of national lasting prosperity than that. If it be true, then the seeds of national deterioration are being sown. Nothing would be more wholesome, more inspiring, more helpful to national prosperity than a revival of religious faith and observance, and business men could make no better investment of their money and time than to push such a movement along.

"Thou shalt not make to thyself any graven images."

How about the worship of the golden calf of wealth and luxury? Perhaps there is no more of this than formerly. One of the most respected business men of Hartford wrote to me the other day that luxury was a good thing for the country, that the expenditure of money upon other things kept money in circulation, men employed and trade active. In like manner it might be said that wars, earthquakes and fires were good because they created new demands. Superficially, this is true. Actually luxury, that is to say, excessive expenditures of money on things that are not necessary, is, like war, destructive. More than that, it is demoralizing. Russell Sage, with all his penuriousness, was a better example to our young men than some of our new rich men with their lavish display of luxury. I may add that at this time one of the features of the business situation to be deplored and feared is the fact that, owing to this growing love

The Development of American Finance

of luxury which is spreading through all grades of society, we are spending so much and saving so little.

Why is it that France, with only 207,000 square miles of territory and thirty-nine millions of population is such a stupendous financial power, and is able at all times to command such immense investing resources? It is because every man, woman and child in the country saves something out of his income. Saving is the keynote of French industry. In this country the waste of national resources has been shameful.

"Thou shalt not take the name of the Lord thy God in vain."

No one who goes to our great cities can have failed to notice a marked decline in profanity in the past few years. Whatever may be in our hearts our lips are at least cleaner. It is beginning to be recognized that profanity and obscenity are unmanly.

"Remember that Thou keep holy the Sabbath day."

There has been a marvelous change in the observance of Sunday in the United States during the past generation. From the strictness of Puritan observance we are rapidly swinging to the opposite extreme. The only safe and reasonable position is between these two extremes. France is as far removed from Puritanism as it is possible to be and yet it is one of the significant events of the present year that in France, and apparently strictly upon economic grounds, there has been enacted there a law making one day's rest out of seven compulsory. It is a fair question to ask whether in this country we are not drifting too far away from that rule. It seems to me that some of our rich men are setting a bad example in this respect and need to be called into account for it. They are compelling a great many people to work on Sunday for their pleasure and instead of making the day one of rest, they are occupying it to a very large extent, if not in business and conference, then

in conspicuous pleasure. The introduction of the automobile, beneficent as it has been in many other respects, is responsible not a little for the misuse of the Sabbath.

"Honor thy father and thy mother."

Perhaps it would be too sweeping a generalization to say that reverence has about died out in the United States, but it is a fact to be noted by everybody that it is certainly at low ebb. This fact is responsible in no small measure for that indifference to law, that contempt of authority which is making for anarchy alike in high and low places. No share of stock, no bond, no business contract has any value except it be safeguarded by respect for law and authority.

"Thou shalt do no murder."

Human life has a value which it never possessed before and we are certainly doing much by police protection, health laws, sanitation and otherwise to protect it. We owe a stupendous debt of gratitude to the medical profession for having lowered the mortality rate in so many of our crowded cities. Nevertheless, I would call on you to witness the lynchings, the labor riots, and the railroad accidents; all of which testify loudly to the fact that human life is still held in low esteem by many people. The fact that in 1895 the number of passengers carried upon the railways of the country to every one passenger killed was 2,984,832, while in 1905 the number of passengers carried for every one killed was 1,375,856 shows a condition of increasing carelessness to human life that is not altogether flattering to the United States. We are so eager for results that we are not always careful about means and we are in so much of a hurry that we pay too little attention to safety.

"Thou shalt not commit adultery."

The home is or should be the center of civilization. Shall we permit it to be destroyed? What answer do you make to this question? Certainly

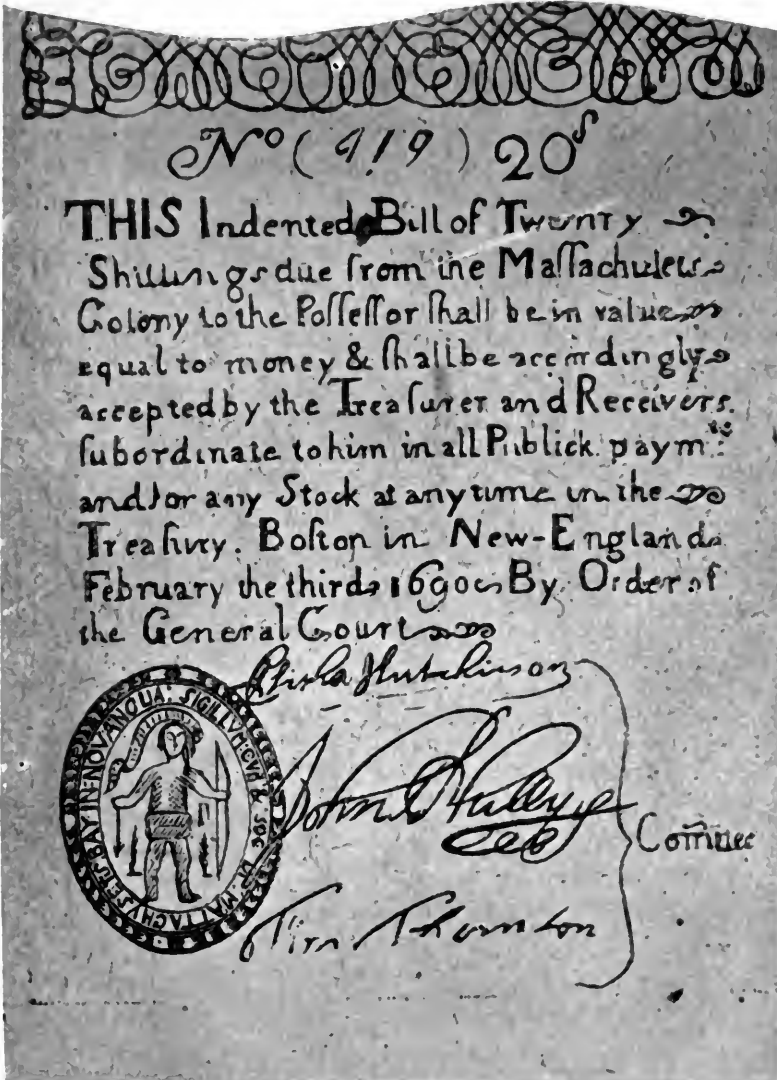

FIRST PAPER MONEY IN AMERICA IN 1690

BY HENRY RUSSELL DROWNE
 of the American Numismatic and Archaeological Society

This is an actual facsimile of the First Paper Money in America, which eventually led to the founding of the American banking system. The American Colonists prior to the reign of William and Mary were prohibited from coining money. In 1693, the Colonists of New England and New York sent an expedition against Canada, which was unsuccessful. On the return of the troops from Boston there was no money with which to pay them. The soldiers clamored for payment and were on the verge of mutiny when it was resolved to resort to Paper Money and a Committee was empowered to issue £7,000 in bills from five shillings to five pounds. This was Paper Money introduced by Massachusetts in 1690. Carolina followed in 1704, in consequence of an ill-advised expedition to St. Augustine, Florida, which entailed a debt of £5,000. In 1709, New York and Connecticut first issued bills of credit and the other Colonies followed in due course, Georgia being the last. Paper Money, which had been first authorized to meet the necessities of Colonial Treasuries to wage war, soon became generally established in relieving commercial and financial embarrassment, and continued in use until after the close of the Revolutionary War and in fact until the establishment of the United States Mint at Philadelphia in 1792.

The Development of American Finance

the growth of divorces in this country is something which business men simply from purely business motives should take measures to check. Dr. Dix in Trinity Church, which stands at the head of Wall street, only a few days ago said that in the past twenty years there have been 500,000 divorces in the United States against 214,000 in Europe, although Europe has five times the population of the United States. Our material prosperity can have no permanency if accompanied by moral deterioration.

"Thou shalt not steal."

This opens a wide subject. On the one hand there is to be witnessed a wonderful increase in honesty and on the other a most shameful lack of it. One of the most magnificent spectacles which this country of enormous wealth presents is the scrupulous care which is exercised by the great body of our people in the actual handling of money. Our inland trade amounting to at least \$22,000,000,000 a year is carried on with an infinitesimal loss caused by actual theft. The great body of our servants in the banks and public institutions through which millions of money pass every week account for every penny of it.

The enormous bulk of Wall street transactions require no written contract. In the stock exchange millions upon millions of property are transferred every day simply by the nod of a head and the raising of a finger. The oral promise has all the force of the written bond. This is certainly a splendid spectacle of honesty. I think few people appreciate the full significance of this fact and give Wall street the credit which it deserves in this respect. The world has gained much in having gained this.

But there are other forms of stealing than actually putting one's hands into the till and filling one's pockets with the contents thereof. There are other kinds of stealing than going back upon one's contract and refusing

to fulfill one's promises. In the present transition age of American business, at this time when we are applying upon a colossal scale the mechanism of corporations and syndicates and promotion, new forms of stealing have developed, to a large extent, let it be admitted, unconsciously; so that people are actually robbing their neighbors oftentimes under the very forms of law. There has, therefore, developed what President Roosevelt calls a "law honesty," which in effect is criminal dishonesty.

Suppose we apply this commandment, "Thou shalt not steal," to the stock market and to some of the operations of modern business and see what becomes of it.

A corporation by clever bookkeeping covers up essential facts as to its financial condition and thus leads investors astray.

Is that stealing?

A director by reason of his confidential position gains advance knowledge of a coming dividend and uses this knowledge so as to speculate with absolute certainty in the stock market, thereby profiting at the expense of others and perhaps of some of the very stockholders of whom he is the trustee.

Is that stealing?

A financier by his control of banks and corporations and the mechanism of the markets so manipulates prices as to give a fictitious appearance of prosperity and then proceeds to unload his securities on the public.

Is that stealing?

A trust resorts to oppressive methods of destroying competition.

Is that stealing?

A railroad grants and a favored shipper accepts rebates or other forms of discrimination by which the latter gets control of the trade.

Is that stealing?

A public service corporation unable to get a franchise in any other way buys a board of aldermen.

Is that stealing?

Its Moral Effect on American Citizenship

A professional operator "washes sales" on the curb in order to sell a mining prospect of no or of doubtful value to the public at grossly inflated prices.

Is that stealing?

A promoter makes a present of a "call" on a newspaper reporter in order to get an alluring but deceitful paragraph before the public.

Is that stealing?

A corporation hires the smartest lawyer in the country to tell it how near it can get to the edge of illegality and of even criminal conduct and yet escape any penalty or violation.

Is that stealing?

A bank refuses information on the pretense that it is private business, although such refusal obscures the whole financial situation and puts thousands of investors in peril.

Is that stealing?

We need, do we not, to give a wider interpretation to this commandment so that it shall apply as well to the new conditions of modern trade as to the old forms and practices?

The *London Times* recently complained of "window dressing" by British banks. What is it? Simply making a special showing of strength, particularly in reserve, for the periodical public reports and then, after their publication, going back to the old condition of low reserves and expanded credits.

Is that strictly honest?

The world is to-day prosperous as never before. Russia is the only sore spot in the international situation. But this prosperity is accompanied by an overstraining of bank credits. Wastes by war, earthquake and fire, marvelous enterprise in every part of the globe, \$15,000,000,000 of new securities issued in the principal countries in the past four years, great industrial and commercial activity accompanied by extensive land and stock speculation in the United States, England and Germany,—these have piled up credit liabilities on a dimin-

ishing percentage of reserves, and this fact more than any political disturbance menaces the business situation.

Under such conditions as these suppose that some one undertakes to manipulate the call money rate on the floor of the stock exchange in order to influence the course of the stock market, thereby striking directly at public confidence.

Would that be honest?

Let us not do the injustice to suppose that all the stealing is in these regions of finance and speculation. The other day I stood at the Brooklyn end of the Williamsburg Bridge and saw scores of men and women getting off Manhattan cars and pushing into the crowds around the Brooklyn cars, secure transfers to the latter for which they are not entitled; in other words, stealing five cent rides from an unpopular corporation.

In plain truth, is there not to-day a good deal of downright dishonesty by the people in dealing with the corporations. A gentleman told me the other day that a man in his town burned his house in order to get the insurance. One jury sent the incendiary to jail but another jury decided that the insurance company must pay the amount of the insurance to the wife of the incendiary; in other words, there was no particular conscience in stealing from a rich corporation in order to enrich a neighbor.

In contrast to this and in order to show that high finance with all its ethical shortcomings is capable of presenting a splendid example of honesty, witness James J. Hill's distribution of the profits of the iron ore deal to the stockholders of the Great Northern Railroad. Can any doubt that Mr. Hill with the resources at his command might have been able to reserve this rich melon for himself and his few wealthy associates? Instead of that he carved it up equitably. In this transaction at least he has coupled financial square dealing with magnificent material achievement.

The Development of American Finance

These are some of the questions which the people are considering at this time, and the fact that they are asking them is evidence of a moral awakening which to me is the best possible proof that the world is growing better instead of worse.

"Thou shalt not bear false witness against thy neighbor."

No other branch of business has had a more wonderful growth during the past generation than the newspaper business, and it seems to me as if this commandment is at this time especially applicable to that particular business. By and by the people will take up newspaper reform just as they have taken up insurance reform and will insist upon the establishment of higher moral standards in the conduct of the newspaper press. I am not going to say anything in depreciation of the profession to which I belong, especially as I believe that on the whole it compares favorably with any other department of human endeavor, and I ask you in all fairness whether you would like to live in San Francisco, or in the city of New York, or in the United States if you were deprived of the protection afforded by our free press. Nevertheless there are two classes of newspapers which are bearing false witness. One class we call the yellow journalism. The other class may be called the court circular journalism. The former bears false witness by exaggeration, by sensation, by innuendo, by inspiring hopes of general equality of condition which can never be realized, by inspiring false doctrine and class hatreds. Court journalism, on the other hand, bears false witness by serving as servile organs of political or financial interests, by concealing the truth and by defending wrong.

"Thou shalt not covet."

A part at least of the social unrest of to-day is due to covetousness, to envy of the rich. And while we may properly legislate for fairer methods

in the accumulation and distribution of wealth, we should take care to guard zealously the rights of property and permit no greed, no false philosophy to overthrow that great principle upon which our social order rests.

The Greek philosophers were also the Greek economists. It is essential that ethics and economics should go together, for political economy which is not based upon morality means simply brute force, while a morality which cannot be applied practically to everyday business is simply a useless idealism. It is for this reason that I have this evening endeavored in this superficial and crude way to link some of the business conditions of to-day to the sublime principles of the moral code.

I would not leave the impression that I am a pessimist. I am emphatically an optimist. The very fact that people are so universally talking about these ethical phases of business is of itself a conclusive proof of progress. We cannot tell what the next day, or the next year may bring forth, but in a great measure we can tell what the next ten years will bring forth for this nation. There is not unlikely to be serious disturbance and a grave crisis or two in the meantime, for it always seems that as the richest soil is often on the side of a volcano so under our national prosperity are always burning the fires of possible financial upheaval. But there is an absolute certainty of a great development of American citizenship and American wealth in the coming ten-year period.

In spite of tyranny in high finance and anarchy in low places, in spite of criticism just and unjust, in spite of condemnation and denunciation and investigation, the people of this country now, and in the years to come, will stand up and vote and fight for liberty and justice, and the rights of property, and for equal opportunity under the law to work out their high destiny.

Letters of Early American Warriors

Correspondence

of the First Citizens of the

Nation, Revealing their Personalities and

Private Lives & A Romance of the North and South

more than a Century Ago & Intimate Friendships of Distinguished

Americans & Social Relations of the Families of Officers in the Early Wars

BY

MABEL CASSINE HOLMAN

FROM ORIGINAL LETTERS NOW IN POSSESSION OF CHARLES EBEN JACKSON,
A DESCENDANT OF GENERAL MICHAEL JACKSON



Powder Horn presented to Colonel Michael Jackson in 1782 for his bravery in the American Revolution

THE discovery of these old letters, rich in their side-lights on the personalities of many of the distinguished Americans of the first days of the Republic, is of especial value to the historical literature.

Not long ago I became acquainted with a wealth of ancient documents that had been secreted for several generations in the privacy of one of our oldest homes. I was favored with the permission to delve among them. In them I found revealed much that had hitherto been

unknown to me and through them I gained a clear knowledge of the early American character.

The frankness of these time-worn letters, inscribed by hands that have long since left the affairs of state to other generations, was such that I felt an intimate acquaintance with the writers, and I sought the privilege of bringing them before the public.

In introducing them I wish to make public recognition of the courtesies extended me by Mr. Charles Eben Jackson, a descendant of General Michael Jackson, in whose possession the treasured originals now remain.



Ancient Miniature of
Ebenezer Jackson, Senior,
a Gentleman of the
First Days of the American Republic

Original in Possession of
Mr. Charles Eben Jackson

Intimate Relations of First American Citizens



The Ancient Jackson Estate, "Walnut Grove"—The names of Washington and Lafayette are carved on one of the trees—It was to the hollow trunk of one of these "button ball" trees that the Indian Chief, "Mamoosa," according to one of the old legends, escaped after killing a fellow tribesman about 1650

MORE than a hundred years ago there came from Savannah, Georgia, a gentleman looking for a summer home in the north, and being directed by friends to Newport, Rhode Island, or to Middletown, Connecticut, his choice fell upon the latter place, where he purchased one of the famous Wetmore houses, built as the houses were in those days to withstand the ravages of time, a fine rambling brick structure, with heavy dog-tooth cornices running around the ceilings, and quaint sliding shutters at the windows. The wide colonial fireplaces were decorated in figures and garlands of high relief. The grounds, shaded by stately trees sloping to the banks of the Arawana stream.

It was here, in 1801, that Ebenezer Jackson, the third son of General Michael Jackson, of Newton, Massachusetts, accompanied by his charming Southern wife, and children,

made his Northern home, which is known as "Walnut Grove," and still occupied by his descendants. Some years before this, Ebenezer Jackson had been sent by the government to establish the border-line between Virginia and North Carolina, meeting in Savannah, Charlotte Fenwick Pierce, the widow of Major William Leigh Pierce; he surrendered his heart and they were married in Savannah July 25, 1792. Mrs. Jackson was a daughter of Edward Fenwick and Mary Drayton of Charleston, South Carolina, and a relative of George Fenwick, an agent of the Warwick patent, who, with his wife, Lady Alice Fenwick, were among the first settlers of Saybrook, Connecticut. Brought up in a true Southern home in the midst of wealth and refinement, Charlotte Fenwick developed early into a beautiful woman. When fifteen years old, during the absence of her mother in England, she was placed at school. As the English army approached Charleston the school disbanded, and the teachers

The Correspondence of Early American Warriors

fled. Charlotte took refuge with her sister, Harriette, the wife of Josiah Tatnell, afterward Governor of Georgia (their son gave the beautiful cemetery, Bonaventure, to the city of Savannah. A daughter of Mr. and Mrs. Ebenezer Jackson, Harriette Fenwick Jackson, married her cousin, the famous Commodore Josiah Tatnell of Savannah, who was the originator of the phrase, "Blood is thicker than water"); here she met Major Pierce, and soon after became betrothed to him. The following description of Miss Fenwick at this time is taken from a letter written to Major Pierce by a friend, July 10, 1783:

"DEAR PIERCE:

Last evening for the first time in my life I saw Miss Charlotte Fenwick. She sang 'Return enraptured hours' most divinely. She is rather pretty than handsome. She is lively, facitious and I think abominably clever. The whole town say you are engaged to her—its taken for granted—and now you are ranked on the list of a Northern Gentlemen marrying a Southern Lady."

The writer adds:

"I am a little in love—not much."

Mrs. Fenwick, upon receiving

word of the trouble in Charleston at once hastened home to find her daughter Charlotte married to a stranger. Highly indignant, Mrs. Fenwick addressed her: "And who is this Major Pierce?" "A gentleman, Madam," Mrs. Pierce replied, haughtily. "Go to your room, Madam, and stay there the rest of the day," which the young bride did. Major Pierce was born in Virginia about 1740; he engaged in the Revolutionary War and was commissioned a captain in the First Continental Artillery, becoming an aide to General Green. After the battle of Eutaw Springs, Major Pierce bore the general's dispatches with the news of the victory to Congress at Philadelphia. On October 29, 1781, Congress resolved "that a sword be presented to Captain Pierce." This sword suitably inscribed is now owned by a grandson of Mrs. Pierce. In 1786, Major Pierce was elected to the Continental Congress from Georgia for one year. Among many valuable documents in the possession of the Jackson family is a small book bound in red morocco



EARLY COLONIAL ARCHITECTURE—WETMORE HOMESTEAD BUILT IN 1746—Erected by one of the first families settling near the Jackson Ancestral Estate in the old Colony of Connecticut

Intimate Relations of First American Citizens



RARE MINIATURE OF MRS. COMFORT SAGE—After Arnold's treason, she sheltered and concealed the traitor's two little sons in her home

and lettered, "Pierces' Reliques," containing the notes taken by Major Pierce while attending the convention, and several interesting anecdotes. A memorandum in Washington Irving's handwriting, pasted within, shows the book to have been borrowed by him. He derived from it the following anecdote for his "Life of Washington:" "When the Convention first opened at Philadelphia, there were a number of propositions brought forward as great leading principles for the new Government to be established for the United States. A copy of these propositions was given to each Member with an injunction to keep everything a profound secret. One morning, by accident, one of the Members dropt his copy of the propositions, which being luckily picked up by General Mifflin was presented to General Washington, our President, who put it in his pocket. After the debates of the Day were over, and the question for adjournment was called for, the General arose from his seat, and previous to his putting the question addressed the



PAINTING OF GENERAL COMFORT SAGE—He was at Valley Forge with Washington—While ill in 1789, Washington sat at his bedside

Convention in the following manner,—

GENTLEMEN:

I am sorry to find that some one Member of this Body, has been so neglectful of the secrets of the Convention as to drop in the State House a copy of their proceedings, which by accident was picked up and delivered to me this Morning. I must entreat Gentlemen to be more careful, lest our transactions get into the News Papers, and disturb the public repose by premature speculations. I know not whose paper it is, but there it is (throwing it down on the table), let him who owns it take it.

At the same time he bowed, picked up his Hat and quitted the room with a dignity so severe that every Person seemed alarmed; for my part I was extremely so, for putting my hand in my pocket I missed my copy of the same Paper, but advancing up to the Table my fears soon dissipated; I found it to be the handwriting of another Person. When I went to my lodgings at the Indian Queen, I found my copy in a pocket which I had pulled off that Morning. It is something remarkable that no Person ever owned the Paper."

PERSONAL NOTES FROM A WARRIOR'S DIARY

Accurate Transcripts from Journal of Major William Leigh Pierce, a Member of the First Continental Congress from Georgia, describing the "Characters in the Convention of the States at Philadelphia, May, 1787"

General George Washington of Virginia—Politician and Statesman

Genl Washington is well known as the Commander in chief of the late American Army. Having conducted these States to independence and peace, he now appears to assist in framing a Government to make the People happy. Like Gustavus Vasa, he may be said to be the deliverer of his country;—like Peter the great he appears as the politician and the States-man; and like Cincinnatus he returned to his farm perfectly contented with being only a plain Citizen, after enjoying the highest honor of the confederacy,—and now only seeks for the approbation of his Country—men by being virtuous and useful. The General was conducted to the Chair as President of the Convention by the unanimous voice of its Members. He is in the 52d year of his age.

Judge Oliver Ellsworth of Supreme Court—Respected for Integrity

Mr. Ellsworth is a Judge of the Supreme Court in Connecticut;—he is a Gentleman of a clear, deep, and copious understanding; eloquent, and connected in public debate; and always attentive to his duty. He is quick in a reply, and choice in selecting such parts of his adversary's arguments as he finds make the strongest impressions,—in order to take off the force of them, so as to admit the power of his own. Mr. Ellsworth is about 37 years of age, a Man much respected for his integrity, and venerated for his abilities.

Colonel Alexander Hamilton of New York—a Finished Scholar

Col. Hamilton is deservedly celebrated for his talents. He is a practitioner of the Law, and reputed to be a finished Scholar. To a clear and strong judgment he unites the ornaments of fancy, and whilst he is able, convincing, and engaging in his eloquence the Heart and Head sympathize in approving him. Yet there is something too feeble in his voice to be equal to the strains of oratory;—it is my opinion that he is rather a convincing Speaker, than a blazing Orator. Col. Hamilton requires time to think,—he enquires into every part of his subject with the searchings of philosophy, and when he comes forward he comes highly charged with interesting matter, there is no skimming over the surface of a subject with him, he must sink to the bottom to see what foundation it rests on.—His language is not always equal, sometimes didactic like Bolingbroke's, at others light and tripping like Stern's. His eloquence is not so defusive as to trifle with the senses, but he rambles just enough to strike and keep up the attention. He is about 33 years, of small stature, and lean. His manners are tinged with stiffness, and sometimes with a degree of vanity that is highly disagreeable.

Roger Sherman—"No Man has a Better Heart or a Clearer Head"

Mr. Sherman exhibits the oddest-shaped character I ever remember to have met with. He is awkward, un-meaning, and unaccountably strange in his manner. But in his train of thinking there is something regular, deep, and comprehensive; yet the oddity of his address, the vulgarisms that accompany his public speaking, and that strange new England cant which runs through his public as his private speaking make everything that is connected with him grotesque and laughable;—and yet he deserves infinite praise,—no Man has a better Heart or a clearer Head. If he cannot embellish he can furnish thoughts that are wise and useful. He is an able politician, and extremely artful in accomplishing any particular object;—it is remarked that he seldom fails. I am told he sits on the Bench in Connecticut and is very correct in the discharge of his Judicial functions. In the early part of his life he was a Shoemaker;—but despising the lowness of his condition, he turned Almanack maker, and so progressed upwards to a Judge. He has been several years a Member of Congress, and discharged the duties of his Office with honor and credit to himself, and advantage to the State he represented. He is about 60.

“ Dr. Benjamin Franklin of Pennsylvania —The Greatest Philosopher of His Age ”

Dr. Franklin is well known to be the greatest philosopher of the present age;—all the operations of nature he seems to understand,—the very heavens obey him, and the Clouds yield up their Lightning to be imprisoned in his rod. But what claim he has to the politician, posterity must determine. It is certain that he does not shine much in public Council;—he is no Speaker, nor does he seem to let politics engage his attention. He is, however, a most extraordinary Man, and tells a story in a style more engaging than anything I ever heard. Let his Biographer finish his character. He is 82 years old, and possesses an activity of mind equal to a youth of 25 years of age.
“When I was in Philadelphia attending the

federal convention June 1787, I waited on Dr. Franklin one morning to pay my respects to him and after some little conversation which was of a gay and cheerful kind he gave me an opportunity to ask him his age, when he informed me he was 82 years old, to which he observed that he had ‘lived long enough to intrude himself on posterity,’ and a few words concerning General Green,— After the raising of the siege of Ninety six in So. Carolina when the American Army were retrenching, an officer of high rank persuaded Gen Green to abandon the States, and to go to Virginia, on which the general replied—‘no Sir I will conquer this Country or die in the attempt.’”

“ Dr. Samuel Johnson—One of the First Classicists in America—Eloquent and Clear ”

Dr. Johnson is a character much celebrated for his legal knowledge; he is said to be one of the first classicists in America, and certainly possesses a very strong and enlightened understanding. As an Orator in my opinion, there is nothing in him that warrants the high reputation which he has for public speaking. There is something in the tone of his voice not pleasing to the Ear,—but he is eloquent and clear,—always abounding with information and instruction. He was once employed as an Agent for the State of Con-

necticut to state her claims to certain landed territory before the British House of Commons; this Office he discharged with so much dignity, and made such an ingenious display of his powers, that he laid the foundation of a reputation which will probably last much longer than his own life. Dr. Johnson is about sixty years of age, possesses the manners of a Gentleman, and engages the Hearts of Men by the sweetness with which he accosts his acquaintance.

Major Pierce died December 10th, 1789, and three years later Mrs. Pierce became the wife of Ebenezer Jackson.

After buying “Walnut Grove” Mr. Jackson greatly improved and beautified the old mansion. The walks winding in and out among the ancient trees and terraced lawns were bordered with boxes of orange and lemon trees Mrs. Jackson sent from the South. The gentle murmur of the stream, with the sounds of childish laughter, and the patter of little feet guarded by colored mammies made it an ideal home. Mr. and Mrs. Jackson usually made the journeys between Middletown and Savannah by water, until their lives were

endangered by a severe storm, during which one of their slaves who was very ill and frightened, begged the captain to put her ashore and “let her walk home.” After this the trips were accomplished by carriage, the journey taking five or six weeks. Occasionally a winter was passed in Middletown, and “Walnut Grove” became the scene of many social gatherings. The table is still there on which Major Andre took tea. Mr. Jackson owned the first carriage in Middletown, and frequently Mrs. Jackson would send the carriage for her friends that they might enjoy a game of cards to while away the long winter evenings.

After some years Mr. and Mrs.

Intimate Relations of First American Citizens

Jackson decided to locate permanently in the North. Great was the grief of the slaves who with tears in their eyes begged to be taken north with master and mistress. They were not separated but all found a home with a relative of the family. Mrs. Jackson died in Savannah, April 4th, 1819, where she is buried. Ebenezer Jackson spent his last days in Middletown, where he died in 1836, and was buried in Indian Hill Cemetery.

It was at "Walnut Grove" that Ruth Parker Jackson, the widow of that grand soldier, General Michael Jackson, passed her last days. Mrs. Jackson was a true soldier's wife; not only did she bravely see her husband depart to lay down his life if need be, for the freedom of the new country, but with him served their five sons. General Jackson was a descendant of Edward Jackson, a nailer of London, who settled at Cambridge, Mass., in 1643. General Jackson was born in Newton, December 18th, 1735. And it is a very strange coincidence that his son Ebenezer, was born on the same date. His great-great-grandson, born December 18th, graduated from West Point in 1900, and entered the army; and another great-great-grandson, born on the same date, desired to enter West Point, but was unable to get an appointment. Every member of the family born on December 18th either follow, or desire to follow, a military life. General Jackson served from the battle of Lexington to the close of the Revolutionary War with his five sons, all officers of the Continental Line—Michael, jr., Simon, Ebenezer, Amasa and Charles. Four brothers of General Jackson enlisted for three years of the war, and two more brothers served as volunteers from time to time.

General Michael Jackson and his five sons were all members of the Society of Cincinnati. When raising his famous 8th Massachusetts Regiment, he tried to have his five sons mustered in, the three youngest were

rejected as too young, but he finally succeeded with another muster-master in having them accepted as drummers and fifers, and maintained that boys were better than men for that service. The eldest of the three, Ebenezer, was but thirteen, and the youngest, Charles, only ten. General Jackson first served in the Colonial army during the French War, and was present at the siege of Louisburg, and later was assigned to the command of a company of Minute Men. Before the Battle of Lexington while on his way to Boston on horseback one morning before day light, with his panniers filled with "garden sauce," the Sergeant of the minute company at Cambridge, Major Timothy Jackson, met a man coming from the city to inform them of the British having started for Lexington and Concord. He immediately turned back and dismounting at the Meeting house, the rendezvous of the company, rang the bell. By sunrise the whole company was present with the exception of the Captain, who sent an excuse of illness. Michael Jackson was nominated and unanimously chosen to fill his place. Wasting no time in returning thanks, he at once marched his men to the regimental muster ground, and found the officers of certain companies in council deliberating as to further plans. As soon as General Jackson had an opportunity to speak, he told them no brave men would stop to deliberate, all they needed to do was to pursue the enemy to Lexington, and no time was to be lost. The council broke up and all proceeded to Lexington, where they arrived in time to engage the enemy, until they re-entered Boston.

The following letter, written from Savannah, in 1823, from Ebenezer Jackson, to his son, Ebenezer, jr, concerning his grandfather's brilliant service during the Revolutionary War, pictures the scenes as nothing else can do.

The Correspondence of Early American Warriors



PORTRAIT OF A REVOLUTIONARY MATRON
—Mary Wright, Daughter of Captain Wright, a friend of the Jacksons—She married Richard Alsop, merchant, ship owner, and successful West Indian trader—After her husband's death she took the management of the business and became an importer of sugar, molasses and mahogany

SAVANNAH, MAY 7TH, 1823.

MY DEAR SON:

With respect to the history of my late father's life, my recollections are imperfect. I believe the date of his age and death is recorded in his family Bible now at Middletown. When quite a young man he was appointed a subaltern officer and was attached to one of the Massachusetts Provincial Regiments. I do not recollect to have heard him say what services he performed. I think he marched to join Gen. Amerst at Ticonderoga or Ft. Edward. On his return from this tour of duty to the Westward, he engaged and went with the Provincial Troops as a subaltern at the taking of the Island of Cape Breton where he saw some service. He was one of those who under a disguise of Indian dress destroyed the tea in Boston at the commencement of the Revolution. At the early commencement of the troubles between England and her colonies, when the people in the different towns in New England began to prepare an opposition to the Mother Country by raising Minute Companies to be ready at a mo-

ment's call, and to be better disciplined than the common Militia, a company was raised in Newton, and the command assigned to Capt. Michael Jackson, in consequence of his former military experiences, and the high opinion they entertained of his courage and personal firmness. This Company he lead into the memorable first battle of Lexington, at which time all the officers were armed with guns, and my father who was a firstrate shot, informed me that he had 32 thirty-two very fair and deliberate shots at the enemy on that day. Soon after this battle, Captain Michael Jackson was promoted to the rank of Major in the Regiment commanded by Col. Gardner, who afterwards lost his life from wounds received in the Battle of Bunker Hill. At the Battle of Bunker's Hill, Major Michael Jackson acted in the most spirited manner during the whole of that action, and informed me repeatedly that on that day he had forty-two very fair shots at the enemy, many of which were deliberately fired as near as Eleven to Thirty yards distance, and I think he said his piece was loaded with a ball and 3 buckshot. He informed me



RARE PAINTING OF A REVOLUTIONARY MOTHER—Mrs. Wright, wife of Captain Wright—Her ancient home was built of the first bricks that were ever made in her State, and probably in all New England

Intimate Relations of First American Citizens



ANCIENT CANVAS OF FIRST MAYOR OF AN OLD AMERICAN MUNICIPALITY—Colonel Jabez Hamlin, a politician of the Revolutionary period, a friend of the family of General Jackson, and first Mayor of Middletown—His love affairs are an interesting story—When a student at Yale he stood on the dock one Commencement Day looking out into Long Island Sound through a field glass—In a sloop he spied a girl—Young Hamlin exclaimed “That girl shall be my wife,” and the wedding occurred a few weeks later

that the day was so very hot that he threw away his coat and on the retreat near the margin of Bunker's Hill towards Cambridge, he rallied about twenty-five men, all he could collect, and made a stand, which checked the advance of the British, as they suspected some kind of an ambush, that he and his little party stood their ground until they had discharged ten or twelve rounds, and often within twelve yards of each other, that in the last skirmish, while taking aim at the enemy, he received a ball through his Bayonet Belt which passed through his jacket and shirt, just drawing blood from the side of his ribs, and passed through the other side of his Bayonet Belt, so that to see him after the action, it would appear that the ball must have passed through his body. What saved his life on that occasion was the attitude in which he threw his body while

taking aim at the enemy. It was acknowledged by all his acquaintances that Major Michael Jackson has performed most distinguished and gallant services to his country on that memorable day. Major Michael Jackson was immediately after promoted to the rank of Lieut. Colonel in one of the Regiments of the Massachusetts Line, which was ordered on in the year 1776 to the defence of New York. This Regiment was stationed at Hell Gate, before which the British opened several heavy batteries of cannon and Mortars, and during eight days the cannonading and bombarding was continued mostly day and night until all our great guns were dismounted and incapable of further use. About this time or a few days after, the action of York Island took place. Col. Michael Jackson was in the hottest of this action, and a ball from the enemy carried

The Correspondence of Early American Warriors

away a part of the smaller part of the breach of his musket, and cut his fingers slightly. Soon after the Americans retreated from York Island, with the exception of Fort Washington. While the Regiment to which Col. Michael Jackson was attached lay a little above King's Bridge, General Heath projected an expedition to capture an Island, called Montresor's on the East River, where there were about 80 British Troops, with fifty or sixty officers belonging to the British Army. The command was given to Col. Jackson, allowing him to take 260 men as volunteers. They went in 5 boats, and passing down the Harlem River, the American sentinels frequently fired upon the boats, and gave the alarm to the British on the Island. On Col. Jackson's arrival at the mouth of the Harlem River, he reported to General Scott then commanding on the spot, and asked his orders, what he should do. Gen. Scott replied that Col. Jackson might do as he pleased. His reply then was, "I must go on, but must proceed under every disadvantage." Accordingly he arranged his plans, so that one boat with 60 men, commanded by a Captain, should advance on the right, and another boat of equal force to advance on his left, and with three boats he would lead the van in the centre. His own leading boat was the smallest with only 42 men. Commenced their approaches to the Island. There was no means of chaining the boats together, so that as the leading boat advanced, the British in perfect order hailed the van boat and ordered them to lay on their oars. Col. Jackson told them not to fire, and pushed forward his boat for the shore. The British commenced a heavy fire on the boats, and all the boats fled with the exception of the one in which Col. Jackson was, who effected their landing, charged and drove the British, expecting to be instantly seconded by the troops in his four other boats. The British seeing the party so small renewed the attack. Major Hendly, an aid of Genl. Heath, who had volunteered his services was killed, the Major who was second in command was badly wounded, and a Captain of the British Navy who had taken part with the Americans and volunteered his services on this occasion, fell dead, and Col. Jackson received an ounce ball about 2 inches below the right knee, which split one bone and broke the other bone of the leg. So severe was the shock, not more than 12 yards off, that he fell to the ground. His men came to his assistance, and told him he was deserted by all his other boats, and they urged him to allow them to assist him to the boat, and endeavor to effect their retreat, which they did under a most galling fire. The whole party of 42 was killed or wounded, with the exception of 8, and there were counted 32 ball holes

through the sides of the boat on her arrival back. Several captains were broke for cowardice, and Col. Jackson languished for eighteen months before the ball could be extracted, and I have it in my possession, being so bruised by the bones that it measured 1- $\frac{3}{4}$ inches in length and $\frac{3}{4}$ inc. in width.* In the organization of the army at the commencement of the year 1777, Col. Jackson was promoted to command of the 8th Massachusetts Regiment, and as soon as he had sufficiently recovered from his wounds, he took the command of his Regiment, and continued that command until he was promoted to the rank of Brevet Brigadier General, and in November 1783, with the rest of the Revolutionary Army, honorably disbanded, and retired to private life.

I have written the foregoing in great haste, and from my best recollection. When you write it over again, do not say too much, but try to imitate Facilities of whom Pliny said everything he wrote would be immortal. How interesting is a plain, simple and well told story or narrative.

Your ever affectionate father,

E. JACKSON.

An interesting incident related by General Jackson during the Battle of Bunker Hill is that on the retreat he met quite an aged man standing by a stone wall armed with a musket which he was loading with swan shot from his hat that lay on the ground between his feet; to the urgent advice of Major Jackson that he should leave the field, he replied: "I must have one shot more," and curiosity detained the major long enough to see what the effect would be of ammunition. When the charge struck the British line, one man fell, and others were evidently wounded, but Major Jackson was never able to learn who the brave old patriot was, or what was his fate. Perhaps the nearest of General Jackson's personal friends was a man of whom every patriotic American should justly be proud, although for many years, through the force of circumstances, his name rested under a cloud, only

*This bullet is now in the possession of the New England Genealogical & Historical Society.



Ancient Miniature of
Charlotte Fenwick
a Beauty of the Revolutionary Period
in America

Original in Possession of
Mr. Charles Eben Jackson

Intimate Relations of First American Citizens

in the end to shine clearly and truly. This man was General William Hull. In the following words he informed one of General Jackson's sons of the death of his father, General Hull being one of the executors of his will.

NEWTON, 20TH APRIL, 1801.

DEAR FRIEND:

Before this reaches you, you probably will have heard of the death of your Father. On the 14th inst., his funeral was attended with all the honors which possibly could have been conferred on him. For a particular account of it, I refer you to your brother Ebenezer. He died as he lived, firm, dignified, and satisfied. Enclosed is a copy of his will. He mentioned you in his last moments with tender affection. I was with him when he expired, and he was easy and tranquil. I hope your health is restored, and shall have the pleasure of seeing you this Summer. It would be a happiness inexpressible to your mother.

I am very sincerely your friend.

WILLIAM HULL.

This friendship continued not only during the life of General Jackson, but into the lives of his children and grandchildren. In 1824, when General Hull first published the accounts of his campaign in the War of 1812, he wrote several letters to Ebenezer Jackson, junior. The following two are of the greatest interest, showing his strength of character and deep feeling.

NEWTON, 27. JANUARY 1824.

DEAR SIR:

I have received of the 10th., and we were highly gratified with the account you gave of our children at Augusta, particularly of the character you gave of our dear Granddaughter Sarah—I took the liberty, a few days ago to prepare a sketch of my revolutionary services, with a number of documents, to substantiate the facts stated which I enclosed and sent you. I did it at the earnest request of Mr. and Mrs. Campbell, who wrote to me that they conversed with you on the subject, and you was so kind as to say you would arrange from such documents, and select such as would arrange from such documents, and select such as would be suitable to present to Mr. Walsh, I likewise enclose letters to my friends Messrs. Binny and Sergeant on the subject, as it is a large packet I left it with Dr Clark of Boston, to be sent by a private conveyance. My time, this winter, has been employed in writing memo-

ries of my unfortunate campaign of 1812-6 have nearly completed them, Mr. Benjamine Russell Esqr., the printer of the Columbian Centinel, has read a few of the numbers, and is very desirous of publishing them in his paper—He offers to begin where I am prepared. He does it gratis, and presses me very hard for the privilege, as he calls it. Perhaps when it is published Mr. Walsh may be desirous of examining it—it will be founded on authentic documents, principally from the records of the Government. And, certified by the present Secretary of War,—the former Secretaries refused them to me. I do not know that Dr. Clark has as yet, had a private opportunity to send you the packet to which I alluded if not it shall be sent on. In looking over my old papers I found the account which I wrote of your Grandfather's funeral which was printed. I do myself the pleasure of sending you the original. With very great respects, and with strong wishes for your prosperity and Happiness.

I am your Friend, and.,

Most O. B. S.

WILLIAM HULL.

P. S. As it may be a satisfaction to you. I enclose a small lock of your Grandfather's hair which we have preserved, from our high respect to his memory.

Three months later General Hull writes:

NEWTON, 17TH APRIL 1824.

DEAR SIR:

Next Monday, the 19th inst., the first number of my memoirs will be published in the Statesman, a republican paper . . . it will likewise be published in a daily paper, edited by Mr. Buckingham and probably a considerable part of the first number, and the others will be copied in the Sentinel. . . . The first is merely an introductory address—The whole will contain about 35 numbers, and two will be published every week, until the whole are finished. . . . Mr. Walsh will have an opportunity of seeing them and by the documents and evidence which will be published in support of the facts, and be able to form an opinion on that of our History. From what I know of his character, I feel confident, truth alone will be his motive. When I was ordered to Philadelphia for my trial, I recd, great attention: and liberality and candour were manifested. . . . All I can now wish is, that the subject may excite inquiry, and the facts may be known, as thus alone I depend for the vindication of my honour, and the rectitude of my conduct . . . all my statements are proven by the records of the Government, and the best evidence the nature of the case will admit. The Administrator

The Correspondence of Early American Warriors

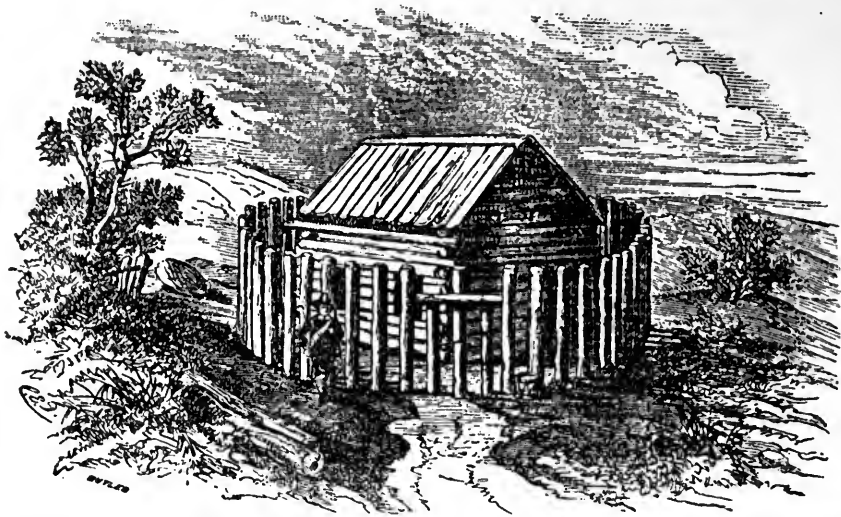

OLD PRINT OF ONE OF THE FIRST MEETING HOUSES IN AMERICA—The first church was twenty feet square and surrounded by pallsades. The congregation was summoned to meeting by the tap of a drum, presented to the town by Giles Hamlin. A guard of eight men and a corporal were kept outside during service. This meeting house was located in the ancient community of Middletown in the Colony of Connecticut

Genl. Dearborn, the Court Martial, and other officers will be deeply implicated. There will be powerful opposition to my attempt to exhibit the truth of the events which then took place. . . . Many characers who now have great influence will be brought into view in a manner not pleasant to themselves, or friends. . . . Fearless of any consequences I shall tell the truth, and produce evidence in support of it. . . . If there is any action of my life, on which I reflect with pleasure un-mixed with any alloy, it is my conduct for which I have been condemned—Nothing influenced me but a sense of duty, and my strong wish is to show that even my judgement did not deceive me, and that I faithfully performed my duty. . . . I hope you will receive the papers in which the History of these events will be published, and I have no other request but that my fellow sitizens, will form an opinion of the facts, which will be proven. Mr. and Mrs. Campbell will be in Phil, probably in May. . . . In conformity to their opinion I have published the History of my campaign in the republican paper. It has already excited much attention here, and probably will be published in many papers. With true friendship, it is a happiness to me to subscribe myself.

Your very sincere and effectonate
friend.

WILLIAM HULL

P. S. I sympathize most sincerely with your family in the death of so admirable a character and so useful a citizen as your

uncle Amasa. I hope you will not come to M— without visiting this part of the country and viewing the spot, which was the residence of your venerable ancestor, and the Tomb where his remains rest, and making my house your home—in such a visit, I think you would find an interest and it at least would make us happy.

Mrs. Ruth Parker Jackson often told many thrilling stories of the events that occurred while she was with her husband at Washington's headquarters. Here she nursed the sick and cared for the wounded soldiers, often feeling that she was needed at home, and must go. General Washington would urge her to remain. The late Governor Eustis, who had been a surgeon in General Jackson's regiment, said: "I remember of meeting him once at General Washington's table at West Point, and after the cloth had been removed, the General beckoned to Colonel Jackson to come and take a seat by him, and unbent himself more than I ever saw him do to anyone." The following letter written to Ebenezer Jackson, junior, January 11, 1841, brings to light some additional facts concerning this time:

Intimate Relations of First American Citizens

MR. JACKSON:

Thinking you might be pleased as I was to see your Grandfather's name and weight, with men of such weight of character) and supposing you might not see the Observer, I transcribe it for you. Do you remember your Grandmother? She was an excellent woman, hours have I listened to her account of events that occurred while she was with her Husband at the headquarters of Gen. Washington— Sometimes she said when she talked of leaving for her home where she was much wanted—General Washington would say—“do not leave us Mrs. Jackson, I would sooner spare any General officer of the Army.” The soldiers she said called her Mother, and were so grateful for her attentions to them when sick or wounded, that it repaid her for all that she did—She gave me a detailed account of the dreadful scenes of the poor wounded soldiers who attempted to scale Stony point—and her manner of treating them—administering at the same time, spiritual comfort to them— Indeed Sir, she was an excellent woman, and deserves a monument to her memory far more than many that receive at this time these marks of late approbation. But the extract:

The following memorandum was found a number of years ago in the pocket-book of an officer of the Massachusetts Line:

WEIGHT OF MILITARY MEN

August 19, 1783.

Weighed at the scales at West Point.

X	General Washington.....	209	lbs
X	General Lincoln.....	224	“
X	General Knox.....	280	“
	General Huntington.....	132	“
	General Greacon.....	166	“
	Colonel Swift.....	219	“
	“ M. Jackson.....	252	“
	“ H. Jackson.....	238	“
X	Lt Colonel Huntington.....	232	“
	“ Cobb.....	186	“
X	“ “ Humphreys.....	221	“

Five of the gentlemen named I have seen, with three was well acquainted— This record proves them men of weight, and most fine looking men was those I have marked—Col. Huntington was among the handsomest men of his time, and that is saying much—for this State had some of the finest looking men at that period that ever appeared probably in our world—Ogden Morely, Pierpont Edwards, John Williams, Donnal Mitchel, Gideon Granger, Enoch Huntington of this town, the two Hosmers—were all handsome men—Gen. Knox and Col. Humphreys were fine persons and well looking.

This memorandum pleased me, I hope it will you, Sir. My compliments to the ladies of your family.

H. WHITTELEY.

JANUARY 11, 1841.

Mrs. Benedict Arnold drank tea with Mrs. Jackson at the latter's home or quarters the night of the treason, and remembered perfectly that Arnold would not sit down but with teacup in hand stood by the window looking across the river, as later facts proved, watching for the signal that the boat was ready to take him to the enemy's camp. And it is remarkable that Mrs. Jackson's grandson married a granddaughter of Mrs. Comfort Sage, wife of General Sage, of Middletown, who, after Arnold burned New London, and the massacre of Fort Griswold, for a time sheltered and cared for his two young sons, and when he was burned in effigy in Middletown and the streets were filled with a mob, drew the window shutters closely and passed an anxious night lest the children should learn the cause of the uproar. Some years later, when a young man, one of these boys called upon Mrs. Sage in Montreal to express the gratitude he should always feel for the kindness shown him by the wife of General Sage.

After General Jackson, under the disguise of Indian dress, helped to destroy the tea in Boston harbor, he forbade the use of it in his house until the tax should be removed, but Mrs. Jackson, who had melted her teaspoons into bullets for her husband, could not forego so delicious a concoction, and often, during the General's absence, brewed for her friends a cup while they chatted over their knitting; if her husband came home unexpectedly, the teapot was quietly placed in the deep drawer of Mrs. Jackson's tea table and the conversation moved on as before. When the fire burns low on the hearth at “Walnut Grove” and the evening shadows come and go, again, to future generations shall these tales be told with increasing pride.

America's Tribute to France

A Centennial Ode to Comte de Rochambeau

BY

JOHN GAYLORD DAVENPORT, D.D.

THIS is the centenary of the death of Jean Baptiste Donation de Vineure, the gallant Count de Rochambeau, who, when America declared her Independence from Mother England, became inspired with liberty and came to this country in 1780 in command of a considerable force of his fellow countrymen to enter the conflict for the American people. He fixed his headquarters at Newport and, having concerted his plans with General Washington, he marched to the neighborhood of New York in the

summer of 1781, effected a junction with his ally, and the two moved rapidly southward toward Yorktown. Rochambeau conducted courageous assaults on the town and was one of the great factors in its ultimate capture. He returned to France in 1783 and later became a field marshal, but was inconspicuous in the French Revolution. He died in 1807 at the age of eighty-two years. During his long life he served in the War of the Austrian Succession and the Seven Years' War. With Lafayette, he was the principal French military figure in the great American Revolution.

Soldiers of long ago,
Who with brave Rochambeau,
Here came to stand for liberty and right,
Across the flood of years
Your noble course appears,
Dimming our eyes with tears,
Waking our eager cheers,
And sphering you in an immortal light.

Your valor we recall,
Your sacrifice, and all
The struggle fierce you made for us and
ours.
The ceaseless flight of time
But speaks your act sublime;
The hurrying centuries chime
In grand, heroic rhyme,
This noble consecration of your powers.

Ah, we can ne'er forget
The princely Lafayette
Who came to aid us in our time of need;
Nor gallant Rochambeau
And Count de Grasse, whose blow
Routed our mighty foe
That all the world might know
America from bonds forever freed!

And many another came
In Liberty's great name
Inspiring us to valor in the fight.
O France, thou radiant land,
By Freedom's fervor fanned,
'Twas thine with us to stand
Thrilling our feeble band
To tireless struggle here for manhood's
right!

A Centennial Ode to Count Rochambeau

We love to tell the tale,
Our "Benefactor" hail,
And bless the great Republic o'er the sea,
Long may the triple hue,
The red, the white, the blue,
The strong, the pure, the true,
Its shining way pursue,
A morning star that lights to liberty!

In glorious slumber deep
Our Lafayette asleep
Lies 'neath its folds, his form a priceless
trust;
And there the men that pressed
This daisied soil found rest,
Their memory fondly blessed
By millions of the West,
Who love the land that holds their sacred
dust.

This humble ode we rear
To sons of France who here
Or elsewhere stood for us in distant days.
To every passer-by,
As years and decades fly,
Its willing lips will cry
The tale that must not die,
And yield our noble helpers deathless
praise.

God of the Nations, now
Beneath thy heavens we bow
And own Thy grace and majesty supreme.
Long as these hills shall stand,
The glory of our land,
May all the service grand
Wrought by the noble band
That came to aid us, be the patriot's theme!

We humbly pray Thee, keep,
Whether we wake or sleep,
The monument that tells the noble tale!
Shield it when tempests lower
From their destructive power,
And in the fateful hour,
When timid mortals cower,
Let lightning's flash nor earthquake shock
assail!

While morn with rose-red hue
This column shall imbue,
And noon its white and eve its blue shall
shed,
May the dear flags that tell
Of those who nobly fell
While nations tolled their knell.
Both sides the ocean's swell,
Still float in splendor, blue and white and
red!

An Anecdote of Count Rochambeau in America

BY

SUSAN E. M. JOCELYN

GRAND DAUGHTER OF THE HEROINE OF THIS INCIDENT

THIS narrative of Count Rochambeau's romantic experience in America is absolutely true, even to the remark of Rochambeau concerning the heroine, and repeated by Aunt Sary, Luciannah Smith before marriage.

She was the daughter of Lieutenant James Smith and mother of Nathaniel Jocelyn, the distinguished American portrait painter. The author is a daughter of Nathaniel Jocelyn and the facts here related have come down through her family and are now recorded as historical anecdote.

"Come Haste to the Wedding"—An Old Song



LITTLE Sarah, whose fingers had for an hour plied wearily through monotonous exercises, gave a sigh of relief when the clock struck five.

Jerking the old green instruction book from the piano rack and complacently spreading in its place her first sheet music, she gave sundry preliminary twitches at her pink gingham skirt, a final painstaking adjustment of her weight on the piano-stool, then braced herself for a fresh start, and brisk little notes came twinkling from rosy finger-tips.

Sarah played them well, bringing gay dancers to the mind's eye as she dashed along, the melody floating out through the open window to the piazza, where the grandmother in a shaded corner made a perfect picture of peace and beauty in old age.

In an old-fashioned rocker, straight and regal she sat, the soft folds of her black dress falling in pleasing curves about her, and the white kerchief gently outlining her bust and shoulders. A widow's cap with its band of black brought into strong relief the burnished silver of her hair, shading a brow of marked smoothness, and the eyes of that unusual shade of blue, matching the sea, still retained their sparkle, and deepened the roses which the suns of many summers had "set" in her cheeks.

When the bright quick notes fell upon her ear, the rocker ceased for a moment its gentle sway, and a new ripple of light came into the blue eyes. Swift-flying needles grew quiet and the half-formed stocking dropped unheeded in her lap; then bending forward to listen, she caught the time of

the swift swinging measures, and her head nodded in unison through all the quick turns.

"Sary," she called when the last note was sounded.

"Yes, grandma," answered the young musician.

"What was that tune you were playing, child?" and Grandma's voice had a tone indicating more than passing interest.

"Come, Haste to the Wedding," grandma; pretty, isn't it?" and young Sarah parted the muslin curtains and sprang through the long windows to her grandmother's side. "You must have heard it before this, grandma," she said. "It is an old song, published in England almost a hundred years ago, so my teacher says."

"It was new to me when I heard it, 'way back in 1781. I danced to that tune with —" and Grandma hesitated, then added in a slightly exultant tone, "with Rochambeau, Sary."

"Grandma!" exclaimed Sarah, "you don't mean the Count de Rochambeau in my history, do you?"

Grandma nodded smiling assent and her granddaughter, a-tilt with interest, clamored for details.

"Wait till I run and call Margaret," she said, and springing down the piazza steps and racing over the lawn she called in a high treble: "Margaret! Margaret! Come in and hear about grandma and the Count de Rochambeau. Grandma knew him and danced with him, and she's going to tell us all about him. Come in! Come in!"

Then little Sarah, repetitious and emphatic, led her somewhat incredulous sister to the piazza.

"Grandma, what fairy tale is this?" asked Margaret, and grandma, for

An Anecdote of Count Rochambeau in America

answer, drew both of the girls down on the seat beside her. Closing her eyes, she sat for a moment in silence, then, with a far-away look into the past, she said:

"One July day, just about sundown, Sister Sary and I were busy putting away the tea-things, when Sylvy Hart came in. She was full of talk and laugh about the French soldiers who were in camp near the town. The spot has been called 'French Hill' ever since. They had marched from Rhode Island to Connecticut and were on their way to meet Washington in New York. It was a great thing for Southin'ton folks to have those thousands of soldiers, in their gay coats, let right down in the town, all of a sudden. All day they had been straying around, and Sylvy Hart said that two of them stopped at her house for a drink of water and her father invited them in to tea.

"Now Sylvy was a great mimic and she showed us just how one of them made his manners when she passed his cup to him. She put her hand on her heart and made a low bow, saying: 'Pretty Polly, pretty Polly!' in a queer little choppy voice, which she said was just like his. 'It was his way of giving a compliment,' she tittered. 'So,' said she, 'I made a curtsy and he made another bow, jumping up from the table every time. Oh, Luciannah Smith!' she said, 'I wish Harvey Upson would act like that.' She married Harvey in the fall, but he never learned to bow and scrape and say 'Pretty Polly!'

"Well, while she was talking, Daddy came 'round to the back steps. 'Come, Luciannah,' said he, 'you and Sary had better smart yourselves up a bit and go along with me. There's a-goin' to be a dance for the soldiers up by the French camp. It's no more than right that we should make things sort o' pleasant for them.'

"Sylvy started right off for home to put herself into trim and Sary and

I got out of our short gowns and petticoats in no time. Mother had gone out visiting, so I dared put on my best white dimity and red shoes, and we wore white gauze scarfs around our shoulders. Behind Daddy we walked up the road, hardly daring to lift our eyes to the beautiful soldiers who peered at us from every side; the green seemed to be covered with them and the colors of their uniforms looked in the distance like bright posies growing there.

"Pretty soon we met Sylvy and Harvey Upson. She was talking and giggling about her Frenchman, which gave Harvey a pretty dark face, and it looked blacker still when the young soldier, along with a comrade, came sidling up, and with his hand on his heart, took 'Pretty Polly' off to the dance ground. Sister Sary followed with the comrade, leaving me with Harvey Upson, who wasn't very good company just then.

"After a while he said in a crusty sort of a tone: 'It's only the low-grade officers who dance with the girls. There's the general, the Count Rochambeau, *he* isn't dancing. I don't believe he'd take any of these girls for a partner. See him over there? Don't he look fine?'

"I felt my color a-risin' and I guess I must have cast a pretty animated glance in the direction marked by Harvey's thumb, for in a minute I saw that the general was staring straight at me. He was standing a little apart from the others, with his arms folded, and was a smallish sort of a man, but was as straight as an arrow. His long, dark-blue cloth coat was faced with red and white, and his cocked hat bore the same colors. He had dreadful piercing eyes and I felt pretty uncomfortable and turned and looked the other way and fidgeted, tying and untying my scarf; then I thought, how foolish I am; 't isn't likely he was noticing me at all; so I slyly gave another little peep at the red and white cocked hat

An Anecdote of Count Rochambeau in America

and the next minute called upon the hills to cover me, for lo, and behold! he was a-crossing right over towards me, cocked hat in hand, and a smile on his face. Then he stopped short, sort o' military-like, made a low bow, and said: 'Mademoiselle?' as though he was asking a question, and held out his hand for a partner."

"Had he been introduced?" interrupted young Margaret, whose ideas of propriety were at that early age well-formed.

"Introduced? No," explained grandma. "It was war times, you know, Margaret, and this was a great general, who had come 'way across the water to help us beat the British. That was introduction enough, child; so I just made my prettiest curtsy, put my hand in his, and with a glance at Harvey, which meant, 'What do you say now?' I went skipping off into the reel with the Count.

"He was not young (fifty years old they said he was), but oh, how beautifully he danced! I had no fear of making mistakes with such a partner. I suppose that was the way he led his troops. Whirling and whirling, this way and that way, forward and backward we went, while the fiddles were spinning over and over the pretty tune that Sary just played. I have never heard it since till to-day.

"You want to know how he talked and what he said? Well, I guess I did most of the talking. He could understand me better than I could him. I don't believe I had ever heard any but Southin'ton folks talk before that. I think I must have been pretty bright or pretty foolish, for he seemed a good deal amused by my talk, and once he clapped his hands and said some funny French words. I didn't know what they meant, unless they were for me to go on dancing, so, as I was serving my country according to my gifts, we danced till the moon came out. Then, when the

music stopped, the Count led me to my father, and said some beautiful sounding words, half English and half French. I took it that he was thanking me for my company, so I said: 'Thank you, Sir,' and dropped a curtsy and he made a low bow, hat in hand, and walked away. In a moment he turned, looked back, lifted his hat once more and smiled. I can see him now, just as he looked then," and grandma sat smiling reflectively.

"You haven't told *all* he said, Lucianah," laughed great-aunt Sary from behind the window-curtain, where she had been living over her own little part in the play of long ago. "Why, children," she continued, quite regardless of grandma's protesting hand, "he told lots of folks that your grandmother was the most beautiful girl that he had seen in America."

"He hadn't been here long, children," was the modest rejoinder, "and sister, you shouldn't ——"

"Was Rochambeau anything like grandpa?" interrupted little Sarah, thus early in life recognizing cause and effect.

"Not at all," laughed grandma. "I wasn't thinking of Rochambeau, child, when I said 'yes' to grandpa. Sylvy Hart and I were not much alike." Then, leading back again into the past, she said: "Why, let me think, children. I believe it's just sixty-five years ago to-day that all this happened. Honeysuckles were in bloom then; the air was sweet with them, just as it is now. I wore some in my belt. Sary, go play that tune once more," and grandma, in the "vision splendid," again tripped lightly through the merry dance with the Count.

And Rochambeau, did ever there come to him again in life

"A lovely apparition, sent
To be a moment's ornament—
A dancing shape, an image gay,
To haunt, to startle, and waylay?"

Experiences of an American Educator in First Years of the Republic

Manuscript of

James Morris, Born in 1752

in which He Tells of being Charged with

Violation of Christian Peace and Placed on Trial for

Conducting a Private School and Instructing Young Women in

Higher Education & Personal Narrative of an Early Lecturer on Public Morals

ORIGINAL MANUSCRIPT IN POSSESSION OF

MRS. WASHINGTON CHOATE

GREAT-GRAND-DAUGHTER OF JAMES MORRIS

SKETCHES BY FLORENCE E. D. MUZZY

THIS is the experience of an educator in the first days of the American Republic. It tells of the persecution that he met in attempting to establish a private school for the instruction of young ladies when the Nation was in its beginning. The public was scandalized by such a project and the instructor was charged with a breach of Christian peace. The accusations were based largely on the questions of morality. It was alleged that society was endangered by allowing girls of an impressionable age to be taken from their homes and congregate under the influence of a male instructor. It was argued that such a system threatened to undermine the virtue of the home and the race; that it gave opportunity for irresponsible men to subject maturing womanhood to their wiles and authority, and that the weakness of all human nature was such that it would be a reproach to the public conscience.

There was considerable doubt as to the morality of education as applied to woman. There was a general feeling that it destroyed domesticity; that it unveiled to them questionable avenues of thought, and that it

wholly unfitted them for the duties of the home.

The public school system which had been in crude operation in America from the first days of the Dutch in New Netherlands and the English settlements was practically abandoned during the American Revolution. Those who had instructed the youth in the rudiments of practical knowledge were engaged in the fight for Independence. As a result a generation was rising that verged on illiteracy.

This life story of a man who endeavored to re-establish it on a higher plane is of vital interest. James Morris, the author of this diary, was born in Litchfield, Connecticut, in 1752, and died in Goshen in 1820. He rendered distinguished and patriotic service in the Revolutionary War. In recent years the vicinity in which he was born has become the town of Morris, in his memory. Mr. Morris continued his work of teaching for twenty years, supplementing it with a weekly lecture on morals. He thus became a pioneer in the advanced education of women. The original manuscript is here transcribed just as he wrote it, and in it is woven the testimony of a man who participated in the War for American Independence.

FIRST PUBLIC SCHOOLS IN NEW YORK

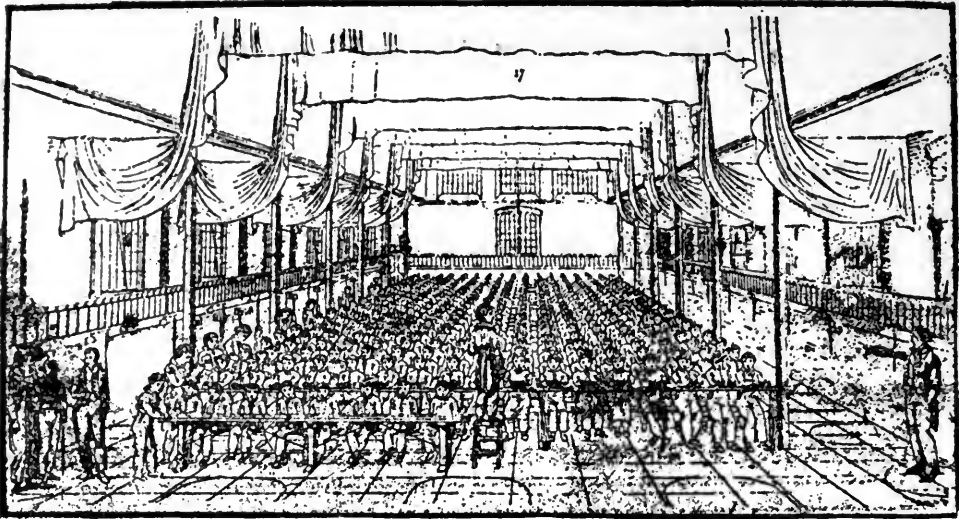

RARE OLD PRINT MADE IN 1840. THE LANCASTER MONITORIAL SCHOOL—An educational idea imported from England, in which a thousand pupils sat in one great room under the control of one teacher, assisted by monitors who passed up and down the aisles to maintain order. There was no Public School system, supported by taxation, in America's greatest metropolis, New York, until 1844. As early as 1805, a system of non-sectarian schools was established and amalgamated with the Public School system in 1853

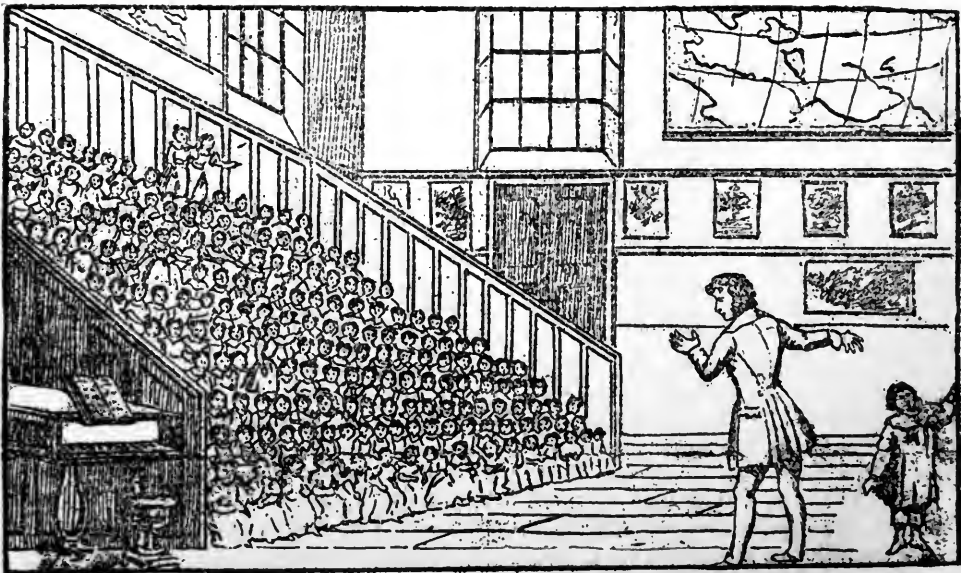

PRINT OF AN INFANT SCHOOL IN NEW YORK IN 1825—The infants sat on a flight of wide stairs on the plan of the ancient amphitheaters. The teacher stood on the floor below and taught by word of mouth. The pupils were marched to and from the school room in lockstep with much formality and rigid discipline. These schools were conducted by a charitable organization which was known as the Infant School Society

Life Story of James Morris—Born in 1752

IN looking back to my early childhood I can well remember that I was very much attached to books. I learned to read when I was four years old and I plead with my father to get me a new Bible. My father told me I might read in his Bible and when I had read it through he would get me a new one. I then applied myself to reading and had read his Bible through by the time I was six years old. He then gave me a new Bible. My father lived three miles from the Bethlehem meeting-house and six or seven from Litchfield. On any Sabbath that I did not remember the text I was made to sit down on a small bench or form, and there to sit till sundown, which I found to be a great punishment, especially in the summer time when the days were very long.

In my youthful days I had an ardent desire to have a public education and to become a minister. But being the only son of my father, he could not brook the idea of my leaving him for that purpose. My father had a right in the Public Library in Bethlehem and the books he drew from time to time I was fond of reading. I was particularly fond of "Watts on the Mind." When I found a sentence of Latin in any book I was exceedingly desirous of knowing the meaning of it. I had often solicited my father to let me go to college and the winter I was eighteen he told me that if I would go and sled home a quantity of wood, I might try what I could do in the study of Latin.

In three weeks I had sledged home sixty boards of wood, loading and unloading the same myself. I then went to live with Dr. Bellamy and was put under the tuition of Mr. Thomas Miner, who was studying divinity with Dr. Bellamy. I studied Lilly's Latin Grammar, no English word being in the book. I under-

stood nothing and I used to study and cry because I got no ideas. But I used to look at my instructor and hear him talk, and I finally concluded that I had as much sense as Thomas Miner and if he had learned Latin and gone through college then certainly I could. I would then plod away again. In the spring of 1770 I returned to my father. It was his idea that I remain at home and study with Rev. Mr. Herbert who was preaching in the place. I made however little progress. It was "James, you must bring in some wood." "James, you must draw some water and bring it in." "James, you must harness the old mare, your master wants to ride." When haying and harvest came on my father said, "Well, James, I think you must lay aside your studies till after harvest. Help is hard to get and we cannot afford to lose our crops." So I shuffled from pillar to post till in the fall I went to Mr. Brinsmade's in New Washington. Mr. Nathan Hale, afterwards Judge Hale of Goshen, was studying theology with Mr. Brinsmade. I had for company, pursuing the same studies, Adoniram Judson and David Judson. In October, 1771, I entered Yale college after passing a good examination. I passed through college, having my share of honorary appointments, and in 1775 I graduated and returned to my father determined to make theology my study. I went in the fall for that purpose to live with Dr. Bellamy with three of my college friends, David Fuller, Seth Swift and Adoniram Judson. I had during my college life many serious impulses and many stirrings of peace. I was disposed to quarrel with the doctrines of election, divine decrees, fore-ordination and free agency. I prayed for divine direction. The study of theology was my delight but I thought my heart was not right. In the midst of these conflicting feelings, I had an invitation to teach the grammar school in

Experiences of an Early American Educator

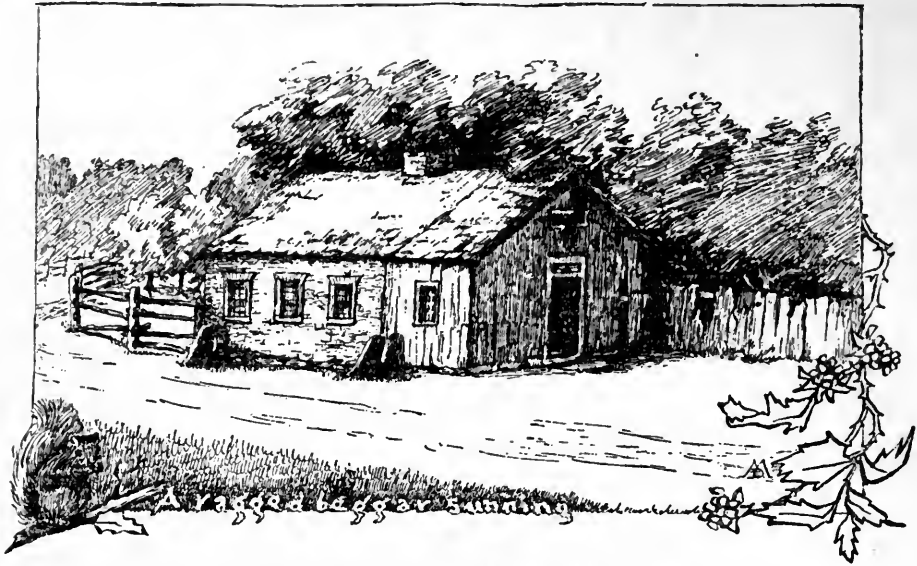

THE SCHOOLHOUSE OF A GENERATION AGO

my native town. I had an offer of handsome wages. I consulted my father, who had been at some considerable expense in my education and felt himself straightened. The Revolutionary war had commenced. The British were in possession of Boston. My father thought I had better undertake to teach the school and accordingly I began in the winter of 1776 and kept the school till some time in the following May. There, unthought of and unsolicited, I had an ensign's commission sent to me from the Legislature of the State to go on a tour for six months to New York. This appointment threw me into a painful situation. I still meant to pursue the study of divinity. I asked Dr. Bellamy's advice and he said that our country was in peril and my father had property to defend. It was a dull time for preachers. We were all in an uproar. The doctor told me that his son, Jonathan, my friend and companion in college was going, and I had better accompany him. I accordingly followed his advice, with the consent of my father, meaning to resume my studies the ensuing fall if I lived to return.

I went to New York with a company of men, was in the battle of Long Island on the 27th of August, was in the retreat from Long Island in the night, when our army made a safe retreat to New York. Was in the battle of York Island the 15th of September. Was in the battle of White Plains. The captain and lieutenant of the company to which I belonged were taken sick and the command of the company devolved upon me. The army retreated from White Plains to Newcastle and General Washington crossed the North River into New Jersey. My time of engagement expired in December but a commission of a second lieutenantcy had been sent me from Congress. The soldiers told me that if I would accept they would enlist. On the first day of January I had a commission sent me of a first lieutenantcy. I finally consented to enter service during the war and I enlisted between thirty and forty men, more than half the company. During the winter of 1777 I lived in Litchfield in the recruiting service and received an order to superintend the hospital in the town for the inoculation of all the

Life Story of James Morris—Born in 1752

soldiers who had not previously had small pox. Nearly two hundred of them were inoculated. In June, 1777, I marched with the men I had enlisted and joined the army at Peekskill. In September, General Washington moved the army into Pennsylvania, and on October 3rd the army had orders to march to Germantown. I left my baggage and my Bible, which my father bought for me when I was six years old, in my trunk. I marched with only my military suit and my implements of war, without even a blanket. The memorable battle of Germantown began on the morning of October 4th. Our army was apparently successful, but by the misconduct of General Stephens the success of the day turned against us. I was in the first column at the head of our company. What began the attack on the enemy was accordingly the last to retreat. I marched with a few men nearly ten miles but was finally captured. I was left without refreshments from break of day till night. Then I was taken back to Germantown after performing a march of nearly forty miles from the evening before at six o'clock. I reached Germantown a prisoner of war and much exhausted. I was the last officer captured. After sundown I asked if I might see the commander of the regiment. The sergeant escorted me to the house where the commander was quartered and after waiting about fifteen minutes the Colonel came out and asked me many questions respecting my motives going to war, rising in rebellion against my lawful sovereign. I answered him pleasantly and as evasively as I could with decency. He asked me what I wanted. I told him I had no blanket. I wished for liberty to sleep in the house and that I stood in need of food. The colonel ordered his servants to get me some victuals. They politely spread a table, set on some good old spirits and a broiled chicken with excellent bread and but-

ter. This was really the best meal of victuals I ever ate in my life. I was told that I must sleep under the eye of the guard. I then asked if I could have a blanket and a large, clean one was given to me. I went out into the field and lay down among the soldiers who were prisoners. The sergeant observed that I had a watch and silver knee buckles. He said if I would give them to him he would return them to me for the soldiers of the guard would probably rob me. I accordingly committed them to him and he very honorably returned them in the morning. Near the setting of the sun on the 5th of October the prisoners were ordered to Philadelphia, a distance of about six miles. We were taken to the new jail and I was locked in a cold room destitute of everything but cold stone walls and a bare floor. Not a seat to sit on, not a morsel to eat or water to drink. I groped about my cell and found two or three persons asleep on the floor. I stood on my feet and leaned my back against the wall and sometimes moved about the room. Then, to change my position, I sat down on the floor. It was a long and dreary and most gloomy night. I reflected on the miseries of the damned in that eternal prison of despair. But still Hope hovered around my soul that I should see another morning. Morning at length arrived and we were furnished with some hard sea bread and salt pork and given some water to drink. Being without money I could purchase nothing for my comfort. I soon sold my watch for half its value. With this money I was able to purchase some food pleasant to my taste. At this time seven hundred prisoners of war were in the jail. A few small rooms were sequestered for the officers. Each room must contain sixteen men. We fully covered the floor where we lay down to rest and the poor soldiers were shut into rooms of the same magnitude with double the number. The sol-

Experiences of an Early American Educator

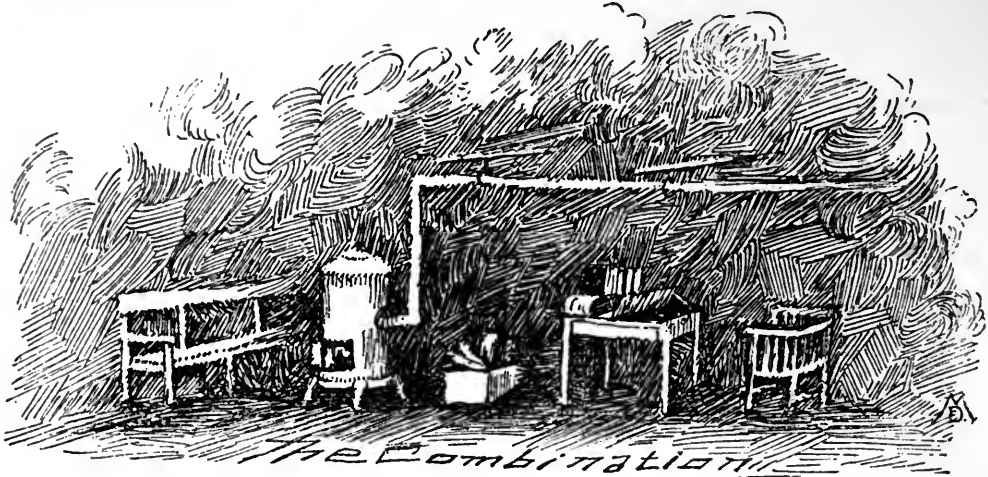

THE SCHOOLROOM OF THE LAST GENERATION

diers were soon seized with jail fever, and in the course of three months it swept off four hundred men who were all buried in one continuous grave without coffins. Such a scene of mortality I never witnessed before. Death was so frequent that it ceased to terrify; it ceased to warn; it ceased to alarm survivors. I made a contract with a family in Philadelphia to furnish me two meals a day at \$2.00 per week, and by the means of this good family I obtained the privileges of the public library in the city. My time was devoted to reading and thus I endeavored to prevent my mind becoming soured by the severities of misfortune. When the British left Philadelphia I was put on board a vessel and sailed to New York. Being put on my parole of honor I boarded with a Dutch family at the west end of Long Island. At Flatbush I became acquainted with a Mr. Clarke who owned the most extensive library I had ever known in the United States. Mr. Clarke made me a welcome visitor to his home and gave me access to his library. In the two years and six months that I was a prisoner at Flatbush I completed a course in ancient and modern history. My exercise was hard labor and

walking. I was treated with great kindness by the family and endeavored to be always on the pleasant side with them. Here I learned that the little nameless civilities and attentions were worth a great deal more than they cost. The 3rd of January, 1781, after a captivity of three years and three months, I was taken to Elizabeth, New Jersey, and there set at liberty. I procured assistance to carry me and my baggage to Peekskill and from there I marched to the Highlands to join the army. In 1778 I was appointed Captain. I directed four men to procure a band and take me down the river to Peekskill where I had left my chest of clothing. The river was frozen near the banks. I landed on a very dark evening and by making a misstep near the shore, where the ice had been cut away for the boat to enter, I fell into the river and could find no bottom. I seized the edge of the ice, calling for help, till the men came to my assistance. A few seconds more would have landed me in eternity.

In the forefront of the campaign of 1781 the army was stationed near White Plains. Several companies had skirmishes with the enemy near Kingsbridge. I was personally in

Life Story of James Morris—Born in 1752

several severe actions, but still I was preserved.

Near the close of the month of August our regiment received orders to march to Virginia. I marched with the regiment at the head of my company to the head of Chesapeake Bay. We sailed down the bay and landed at Williamsburg. Here General Washington with his army encamped a few days. From there we marched to Yorktown. On the 16th, at evening, the light infantry was ordered to take a fort by storm, which was situated near the mouth of York River. I had command of the first company at the head of the column which supported the forlorn hope. Not a man was killed in the forlorn hope. They were so near the enemy before they were discovered that the enemy overshot them. The forlorn hope commanded by Colonel Alexan-

der Hamilton were successful in taking the fort. The French army made an attack on a fort on our left at the same time we made an attack on the fort on the bank of York River. When we had possession of these forts we had possession of the guard overlooking Yorktown. Our artillery began their play upon the town. On the 17th the British requested a cessation of hostilities for twenty-four hours. General Washington replied that he would grant them two hours only. The moment the two hours expired the whole artillery of our Army and of the French discharged upon Yorktown. Before another discharge could be made the British sent another request that articles of capitulation for a surrender might be agreed upon.

On the 18th our soldiers were ordered to wash and appear clean the



MILL AND SCHOOLHOUSE HAVE DEVELOPED SIMULTANEOUSLY

Experiences of an Early American Educator

next day. On the 19th our army assembled on the right and the French army on the left, each line reaching more than a mile on an extended plain. The British army marched out between our two armies, with colors muffled, and after passing in review they piled their arms on the field of submission and returned back in the same manner with Yorktown. On the 20th General Washington issued his orders for a general pardon for all culprits of the army. He ordered the army to assemble for divine service and give thanks to God for our success, chaplains to do their duty praying and preaching to their several brigades discourses suitable to the occasion. Here General Washington's character shone with true lustre in giving God the glory. After this I marched with my men to the Highlands on the east side of the Hudson in New York. In December I received a furlough for a few weeks' visit in Litchfield. While on this furlough I married Elizabeth Hubbard of Middletown. I returned to the army and continued with it until November, 1782, when I was released from service.

At this time I was thirty years of age. I felt a desire to resume my studies in theology and pondered on the subject. My father had become infirm from a wound he had received from an axe. My mother was seventy years old and sunk down in her dotage. My parents were both unwilling that I should leave them and I myself was still doubting and fearing my heart was not right with God. I lived with my parents during the winter of 1782-3 attending to their domestic concerns. My friends and neighbors united in saying that 'I must live in South Farms and be their Justice of the Peace. In May, 1783, I was appointed to this office and chosen by the people as selectman. Thus situated, and notwithstanding my heart had from early youth devised the way to be a minister of the Gospel, yet God designed it should

not be so, but had otherwise directed my steps. In May, 1783, I moved my wife from Middletown and set up housekeeping in my father's house. I repaired the house and barn and as the saying is, I slicked up the place. In my office of Justice of the Peace I was often called on to do business. Courts were often held. Sometimes large numbers of people would attend and we often had company to visit us. My parents chose retirement. My mother could not be broken of her rest. Our visitors would sometimes stay till after nine o'clock and some noise would be made in conversation or when they bid us good-night. In the morning my mother would complain that I should send off my company before nine o'clock. I finally consulted with my father and with his consent decided to purchase the house and land where I now live. At the same time he informed me that I must pay for it myself, as he had no loose money to spare. Everything respecting the purchase was directed by a kind providence, and the bargain was made in December, 1784. I was elated with the idea that in the spring I should set up housekeeping in my present home. But God did not design that I should have altogether so smooth a passage. At the end of February I was cast on a bed of severe sickness with the bilious colic. I was seriously ill for thirty days and my life was despaired of. But by this sickness and distress the door was opened for the people to show me kindness and they became friendly to me. Hence the way was opened for what God had designed I should do for this people. About 1780 Sabbath breaking, profanity and drunkenness were not uncommon among professors of religion. The young children were ignorant and uncivil. In 1783 and 1784 they were taught by ambitious teachers with whom I soon became acquainted. It was agreed that at the close of the schools in spring that the children should gather at the meeting house

Life Story of James Morris—Born in 1752

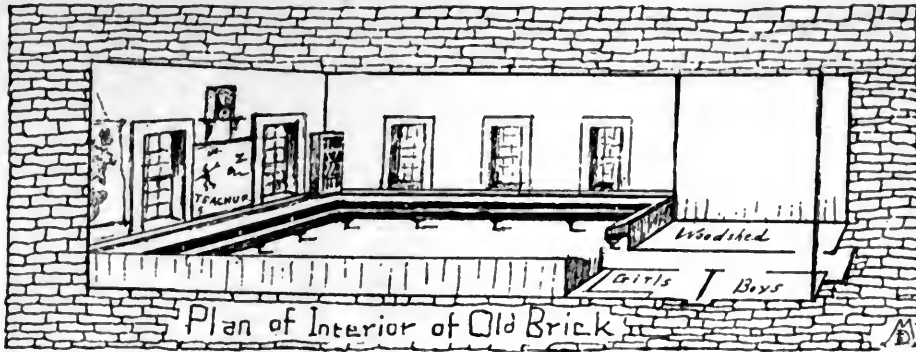

SCHOOLROOM IN MIDDLE OF LAST CENTURY

and that the eight scholars in each school who performed the best should have a book. I procured two dozen of Webster's new spelling books, the first that were introduced into this society, and presented them to the scholars as proposed. From this time forward I occasionally visited the schools. I exerted myself to secure able teachers, and I found there was a promising class of youth coming forward. At this juncture the news spread that the officers of the army had a commutation of five years pay for service during the Revolutionary War. This fired the minds of the community and I became obnoxious to the mass of people because I was an officer of the number. When I had any severe sickness they hoped I would die. One noisy old man said he hoped I would die and that they would take my skin for a drum head to drum other officers out of town.

In June 1789 my dear father died. A considerable sum of money and cattle was placed in my hands by which I was able to free myself from debt. I was at this time thirty eight years old. During my early life I had adopted a variety of maxims, such as these. Never to be wanting in integrity; never to contend in things unessential; adopt an independent mode of thinking; never promise more than I can perform; honor and please the aged. As to

my head I was a Christian while my heart was estranged from holiness. My mind was anxiously impressed with the idea that soon I should be forty years old, and if I sinned away the day of grace till after that period, my crime would be sealed in the book of God against me. On November 7th, 1790, I made a public profession of religion and joined the church in this place. About this time the children to whom I had presented books in 1783-4 began to look to me for further instruction. I gave them access to my library and the best advice I could as to what line of conduct it was best for them to pursue. I informed them I would give them instruction in grammar and geography if they would attend to it. I took more pains with the young ladies in the outset than I did with the others, for experience has taught me that in every place where there was a chaste and virtuous set of young ladies there was a decent class of young men. It was a new thing for ladies to have any more education than could be obtained in the public schools. Reading, writing and spelling were taught. It was often said girls need not learn to write. It was sufficient if they could write their own names. The mode of instruction I employed with the young people met with opposition. It was said I was making an innovation on the manners and customs of youth. I was

Experiences of an Early American Educator

blowing up their pride. A stop must be put to it. In January 1793 I was made a deacon in this Church. The opposition to me increased and I hesitated whether I should take upon myself so important an office. But after consulting with friends and taking the subject into prayerful consideration I accepted the office, I hope with meekness and fear. But the opposition to my school increased. Some men were envious because I was appointed Justice of the Peace at the age of thirty and deacon at the age of forty. Religion was made the shouting horn. I was disturbing the peace of the church. I was too familiar with the ladies in my school. A church meeting was held in July 1794 and a committee was appointed to look into the reports respecting me. One of the brethren of the church charged me with a violation of the Christian peace and enumerated sundry items of my conduct to that effect. It was unanimously agreed to refer the complaints to a church council. The churches of Southbury, Woodbury, Bethlehem, Judea and Warren were sent to for their minister and delegate and on August 27th, 1794, I had a public hearing. A great collection of people assembled as the hue and cry was to see the villain fall. I viewed this trial as a chastisement in the Providence of God to prepare me for what he would have me do. After a long hearing and mature deliberation the council decided that the complaint brought against me by the church was by no means supported. The church was then asked whether it would abide the decision of the council and voted in the affirmative. The question was then put to me and I said I would acquiesce. My persecutors were exceedingly appalled. Some of them soon moved out of the Society, some were taken away by the immediate hand of God, and one of the brethren who was violently opposed to me joined the Episcopalians and was finally excommunicated.

All this persecution turned out to my advantage. My school had hitherto been confined mostly to the youth of this society, but from 1794 to 1803 I had as many pupils as I could attend to, summer and winter. In 1803 sundry good people united and built a large school house and called it the Academy. In November 1804 I procured an assistant. More than 1500 pupils have attended the school coming from all the New England states excepting Rhode Island, also from New York, New Jersey, Pennsylvania, Maryland, Virginia, South Carolina, Georgia and from the islands of St. Thomas and Bermuda.

Soon after I began to teach my school in 1790 I began a course of lectures on morals which I delivered weekly for twenty years. Thus God in His providence has directed me to spend my life in the place of my nativity. If I have ever done any good to my fellow men, let the praise be to Him who hath directed my steps. I have held an office of one kind or another in the gift of the town, for thirty one years. Twenty nine years I have held an office in the gift of the Society. Thirty years I have held an office in the gift of the State. In the year 1798 I was chosen representative from the town to the General Assembly and continued to represent the town for the greater part of the time till 1806. I then declined election. I have had my share of worldly honors. I have had my share of happiness in domestic life. I have been blessed with obedient and affectionate children. I have had a numerous circle of friends and have shared largely in the affections of my pupils. I have many times been ready to exclaim, Why have I been made the subject of so much goodness from the hand of God?

In September 1814 my wife Elizabeth died. Her funeral sermon was preached by Rev. Mr. Lyman Beecher from Job 14, 14. In 1815 I married Rhoda Farnum a lady possessing all qualities to make domestic life happy.

An American's Experience in the British Army



Manuscript of Colonel Stephen Jarvis, Born in 1756,
Revealing the Life of the Loyalists who Refused
to Renounce their Allegiance to the King and Fought
to Save the Western Continent to the British Empire

ORIGINAL MANUSCRIPT NOW IN POSSESSION OF
HONORABLE CHARLES MAPLES JARVIS

DESCENDANT OF COLONEL JARVIS AND MEMBER OF MANY AMERICAN LEARNED AND PATRIOTIC SOCIETIES

THERE are many interesting anecdotes told of the Americans who, while devoted to their country, were opposed to the Declaration of Independence, and believed that

this country could not exist without the protection of the British Crown. It was the first great political problem in America, and divided many families. The Jarvis family in New England differed in their opinions but their sense of justice and loyalty to kin as well as country was such that they did not allow it to disrupt their domestic harmony.

Colonel Stephen Jarvis, whose remarkable life story has recently been discovered in manuscript, and is being presented in these pages, disagreed with some of his relatives as to the holiness of the American Revolution. After seven years' service in the King's army, he preferred not to remain in the new Republic, and removed to Canada. The colonel frequently visited his relatives in the United States and good-naturedly taunted them on being "rebels." While the guest of his cousin, Noah Jarvis, he arose early one morning and began his good-natured banter.

"Colonel," interrupted Noah, who was almost an idolater of Washing-

ton, "do you ever take a morning 'bitter'?"

"No," replied the colonel, "not as a regular thing, but on this particular occasion I shall be gratified to join my esteemed cousin in a friendly libation."

Noah led him into the parlor. Hanging between the windows, in the place of honor on the wall, elegantly framed and in large, bold letters was the Declaration of Independence. Pointing his finger at it he chuckled: "There, my royal cousin, I think is a dram *bitter* enough for you!"

The colonel looked at it and then retorted: "*You rebel!*"

Colonel Jarvis' manuscript, as stated in the introductory to the first installment, is the remarkable story of an American in the British ranks during the American Revolution and is probably the most important documentary evidence of its kind in existence. The first part was presented in the preceding issue of this journal and covered the first years of the Revolution, leaving Jarvis near Charleston (which he frequently writes Charlestown), South Carolina. The great story is concluded in these pages, just as he told it, preserving his quaint orthography.

Manuscript of Colonel Jarvis—Born in 1756

Relating the remarkable experiences as a recruit in the lines of the British army—Accurate transcript from the original manuscript which was lost for many years and has been recently recovered

WE proceeded as far as the Combahee (South Carolina) River. This was a foraging party to procure rice, etc., for the hospitals, and after completing the object intended we commenced our march back and we halted at Colonel Haines' Plantation the night after he was brought home and buried in his garden. I saw his grave. In the afternoon of the next day we left his plantation, and as we had got intelligence that General Marion was collecting a body of Troops to give us annoyance on our route, the order of march was changed, the Infantry and Artillery in front, and the Cavalry in the rear. We marched in this order until we came to a long swamp, a mile or so from Parker's Ferry, when we heard some few shots in front, and Major Fraser ordered the Cavalry to advance, and seeing some Troops at a long distance off, and supposing them to be the enemy, charged over this long causeway and fell into an ambuscade, laid by the enemy, and we received the most gallant fire ever Troops experienced.

An American Fighting His Brothers for Conscience' Sake

We only saw the flash of the pieces the enemy was so complete hid from our view, and we had only to push forward men and horses falling before and behind. We lost one hundred twenty-five killed and a great many wounded, and the enemy retired without the loss of a man. All our Artillery were killed or wounded before they could bring their guns to bear upon the enemy—we halted at Parker's Ferry that night, dropped our wounded, and the next morning collected our dead and buried them, and then proceeded on our route until

we reached Dorchester without any molestation from the enemy.

The day after our arrival at Dorchester, Major Fraser went to Charleston, South Carolina, to make a report of our sad disaster, and he returned at midnight with the news of the battle at the Eretan Springs, and we were ordered immediately to mount and march. We passed Monks' Corner during the day, and after marching all night came up with the Army, where they had made a halt after burrying their dead at the Eretans. The Army retired as far as Monks' Corner for some time sending out patrols far beyond the Eretans. The Americans, after the British retired from the field of battle, came and buried their dead and then retired to invest one other outpost, but our people had abandoned it, and joined the Army, which became so reduced that we were obliged to retreat, and in moving from Monks' Corner and crossing Goose Creek we took the route to Dorchester, and encamped at Sir James Wright's Plantation, a few miles this side of Dorchester. We had a few Militia quartered in Dorchester. We had hardly taken up our ground before some of our Militia from Dorchester came running into Camp, some of them much wounded. A large body of the enemy had charged into Dorchester and surprised the Militia and retired again some miles from Dorchester.

Waging the Revolution in the States of the South

The Cavalry was ordered to march, and we proceeded to Dorchester. I was ordered with two Dragoons and a few Militia forward in order to decoy the enemy, and bring them on, whilst Major Fraser, with the Cavalry well disposed for an attack, kept some distance in my rear. The Amer-

An American's Experience in the British Army

icans, who were ignorant of our Army being in that neighborhood, had the same design with myself, and made several feint charges, and then retired until they had drawn me a sufficient distance to make a successful charge. They had a body of Infantry in their rear. They at last charged me in earnest. I retreated and made the signal to Major Fraser. He advanced and met the enemy, who pulled up their horses within a very short distance, when Major Fraser gave the word and we dashed in among them, and slashing work we made great havoc amongst them, cutting them down and taking many prisoners—an Officer in his retreat took a foot-path that foot-passengers use in that hot country, and there is a row of trees between that and the main road. I pursued this Officer and had got so near as to touch his horse with the point of my sword. I saw their Infantry with trailed arms endeavoring to flank us. I wheeled about and called to Major Fraser, giving him this information, who ordered the Troops to retire, which we did with the loss of only one man, he, poor fellow, was hung the next morning as a deserter from their Army. As we had no Infantry to support us, we were obliged to retire, which we did with a good many prisoners—how many we killed is uncertain—certainly several.

Cavalry Charge against Fellow Countrymen as "Enemies"

The next day the Army retired below the Quarter House, and this was our outpost. In a short time after this a Captain Armstrong of the American Army, took a Captain Keen of ours with his whole Patrol. This gave him a degree of temerity, and caused him to fall into our hands. He one day drove in our Sentinels at our outpicket. Major Coffin, who had been attached to our Regiment, with his mounted Infantry of the York Volun-

teers, was on this day our Commanding Officer—we pursued the enemy for some time on the Dorchester road, but not falling in with them, we crossed the country over the road leading to Goose Creek. The Troops commanded by Captain Campbell was in the rear, and observing some Troops following our track, and dressed in dark jackets, like those of the York Volunteers, I rode forward and asked Major Coffin if he had detached any of his Troops from the squadron. He replied, "No." Then Sir it is the enemy, and they are close by in our rear. We wheeled about and this brought Captain Campbell's Troop in front of the squadron. The enemy formed and for a few seconds seemed disposed to give battle, but soon wheeled and fled. We pursued them in full charge; we had them between us and Charleston, on a fine level road that would admit of about eight horses abreast. We charged the best horse foremost, and I soon led the charge, no horse could run with mine.

"If You Touch this Prisoner I'll Blow Your Brains Out!"

In the distance of about a mile the Commanding Officer of the enemy's (Armstrong) horse plunging into a stone in the middle of the road fell and threw his rider over his head. I had hold of him in an instant, he asked quarters; I gave it him, and asked his name. He said, "Armstrong." Give me your hand Captain Armstrong, I'll protect you, and took him back to the rear. Some of our men made a blow at him, and one came near taking off his scalp. I drew my pistol and said, "If you touch the prisoner I'll blow your brains out." I took him and delivered him to the Officer of the rear guard, and reported him to Major Coffin, and then again pursued the enemy, and soon gained the head of our Troops. By this time the enemy had taken the woods and endeavored

Manuscript of Colonel Jarvis—Born in 1756

to gain the road to Dorchester, separating themselves as much as possible from each other. I saw two Dragoons at some distance in front, and I said to Captain Campbell, "Now, Sir, if your horse can run with mine, and he holds his speed, we will take those two fellows," and we set off in full speed, and I soon left him in the rear, and did not halt until I had taken one of the two. The others made their escape, and here we gave up the chase, and returned to Camp with our prisoners. I think altogether eight, and one was killed by an Officer, whose name was Walker of the New York Volunteers, after he had been made prisoner by one of our Regiment, and gave in charge to his servant. We proceeded to our station and took Captain Armstrong to our mess for refreshment—by the time we had arrived at our quarters, the enemy had escaped had reached their encampment, for at this time the Armies were not a great distance apart, and the American Officers in making their report to their Commanding Officer, represented that Captain Armstrong, when he fell into our hands was treated in the most cruel manner, and described the Officer so very distinctly that Captain Keen of ours, then a prisoner and dining at the table, knew it was me who they had described and who said, "he was sure there must be some mistake as he knew the Officer they had described was too much of a soldier and a man of honor to be guilty of so base a transaction." They still persisted that they saw it, and vouched for the truth of their assertion. The result was that a flag of truce was dispatched immediately to enquire of Captain Armstrong himself the truth of their assertion, and this flag and a letter to Captain Armstrong was handed to him before we had dined, and as he read the contents smiled, which induced us, or some of us to ask if he was so soon to be exchanged. "Not such good luck, but as it is in some measure concerning

the officer who took me prisoner, I will read the communication," which was similar as above stated, and to which he sent the following answer, which he read before he closed his letter. "Sir, it has become my misfortune this day to become a prisoner to the British arms, and I am indebted to the Officer who made me prisoner for my life, and I am not a little astonished that those gentlemen should have presumed to have given you any correct information, as they were so far out of the line of their duty as to know anything of the circumstance."

Exchanging Captured Officers under a Flag of Truce

In a short time there was an exchange between Captain Keen and Captain Armstrong and they returned each to their respective Armies. Captain Keen's account of the matter after Captain Armstrong's letter was read in the American Camp, I shall forbear to mention, and I regret being obliged to say so much of myself in relating this transaction. The next time our Regiment was engaged, Captain Campbell was killed, and it was said purposely threw away his life in this action. I was not with the Regiment. I was detached on James Island with a Troop of Dragoons, under the command of Major Craig. (Afterwards Sir James Craig.)

After I again joined the Regiment, we had another brush with the Americans at Monks' Corner, where we got completely defeated. It was an attempt to surprise a party at this post, but they got intelligence of our approach, and gave us a complete drubbing. We lost one Captain killed, one Captain, two Subalterns and several men wounded, without injuring a single man of the enemy. They had so completely fortified themselves that having no Infantry with us we could not approach them and had to receive their fire without being able to return it, and we returned to our encampment not

An American's Experience in the British Army

very well satisfied with our defeat, altho no disgrace to either Officer or soldier.

Plundering Rich Plantations in the Southern States

About this time a Colonel Thompson (afterwards Count Rumford) arrived from England on his way to join his Regiment at New York. He was ordered to take command of the whole Cavalry, and we had one severe brush with the enemy under his command. We surprised a party in the evening, killed and took a good many prisoners, and the next morning fell in with another large body of the enemy, which we defeated, and drove many of them into the Santee, where both men and horses were drowned. We returned to Camp with (I think) upwards of seventy prisoners. I do not again recollect of being engaged with the enemy during the war. We did indeed after make excursions into the country for the purpose of plundering the plantations of those rich planters, who, after Charleston fell into our hands, had received their Oath of Allegiance, and again had joined the American Army.

Difficulties of British Soldiers in Getting their Pay

Our Regiment had been now nearly a year on actual service without receiving any pay, and those of Captain Campbell's Troop had not received all their bounty, and consequently it fell to my lot to make out the Abstract of the Troop, receive the money and settle with the men, some of which were much in my debt for necessaries found them, as Captain Campbell in his lifetime imposed that duty on me. Major Fraser, who was a knowing chap, was sensible that from death and other casualties, there would be a good deal of pukings (an Army phrase) and he was resolved to take that himself, and had given orders to Paymaster Hatton to pay Officers commanding Troops agreeable to

their present strength only. Hatton and myself were on the best footing and he gave me this information, contrary to the directions he had received from Major Fraser. I only requested of Hatton to let me know when he went to the pay office for the money, and not to go when I was on duty, so as not to be able to attend him immediately on his return with the money. This he did, and immediately on his arrival, and before the Major got intelligence of it I had my Abstract ready and as Commanding Officer and Paymaster of the Troop demanded the amount of the whole Abstract, and as he knew it was my right, paid me the whole amount, which I took and secured in my trunk. I soon had a visit from the Major, but as he found I was as old a soldier as himself, and knew how far I could resist a claim that would not expose me to Military control, he left me to my repose and contented himself in duping the rest of the Officers in what was their right, and robbing them of about £800. We were not so good friends after, altho he did not show any great resentment.

Gambling and Dissipation in the King's Ranks in America

I should be glad that I could throw a veil over the rest of my Military career, but justice demands that I should give a minute detail of all my future transactions. *Know then*, that I fell into all kinds of dissipation, gambling the most prominent, and I continued in that dissipated course of life as long as my money lasted, which amounted to upwards of three hundred guineas. I was left at the close of the war as destitute of money as when I entered the Army, except my half pay, at the reduction of the Regiment in 1783. Towards the end of 1782 the South Carolina, the North Carolina and Georgia Regiments were ordered to Saint Augustine in East Florida to garrison that place and to release a Battalion of the 60th Regi-

Manuscript of Colonel Jarvis—Born in 1756

ment, and soon after our arrival I, as the eldest subaltern of our Regiment, and as our Regiment was first for a Command, I was ordered by General McArthur to take possession of a small fort twenty miles from St. Augustine, and to defend it to the last moment if I should be attacked by the Spaniards, as was expected at that time. I took three pieces of ordnance with me, with Artillery men sufficient to man them, with the assistance of the soldiers of the Regiment, which amounted to twenty-five rank and file, two officers, who were prisoners on parole, a Lieutenant Cornwall of our Regiment, and a Lieutenant Campbell (afterwards Fort Major at Niagara) went with me as companions. I found some difficulty in mounting my cannon for the want of spars, and finding two old masts on the shore, I made use of them, and mounted my cannon, and finding they were private property I returned them to the place I found them, and remained satisfied that I had done nothing wrong. The two gentlemen remained with me for a fortnight, and we spend the time very agreeably until one morning in our sporting Lieutenant Campbell received a wound from a fish called Singarie, something like a turtle, except a long tail, the end of which is barbed, and you often find many of these at low water. Mr Campbell placed his foot on one of them, when he received a wound in the ankle bone from a stroke of this fish, and the barb remained in his ankle, by which he was a long time confined.

Warriors Fishing in Florida while Revolution waged in North

I remained at this post for a month, when I was relieved and joined my Regiment, at St. Augustine, where the morning after my arrival I had a visit from the Sheriff in an action of damages for taking the spars as above related. The Owner, however, did not think proper to pur-

sue his action and I heard nothing of it afterwards. During the rest of my stay in this garrison our duty was light, and balls, plays and gallanting the ladies took up the greatest part of my time, for I had to live very economically to refund the money I had spent belonging to the soldiers in gambling. This I succeeded in doing, but it left me moneyless at the close of the war. In the month of April, 1783, peace was declared, at St. Augustine, and I obtained a leave of absence and sailed for New York, where I arrived on the 9th of May, and made application to Commander-in-Chief (now Lord Dorchester) to visit my friends in Danbury, and to fulfill my engagement with Miss Glover, which had been unavoidably prevented for the last seven years. His Lordship refused me leave until I could obtain permission from the American government, as some of our Officers had gone into the country, and had been very injuriously treated. I, therefore, wrote to my Father, who made application, and obtained a permit for me, which was signed by all the respectable inhabitants of Danbury, and one of my Brothers came to New York for the purpose of accompanying me back. Our meeting was such as you may conceive between Brothers who had been separated for so many years. We left New York and arrived at my Father's on the 20th of April, 1783, Danbury, Connecticut. It is impossible to describe my feelings on again embracing those who had always been so dear to me. Immediately on my arrival, my Father sent for Miss Glover, who happened to be in town.

Soldier's Joy when the War is Over— Going Home

I shall leave the reader to judge of the extacy and the joy that filled our breasts. Immediately preparations were set on foot for our marriage. We were to have been united at the altar of an Episcopal Church, by a

An American's Experience in the British Army

clergyman of that Church, an Uncle of my Mother's, but in this we were disappointed, for the next day all our happiness was marred. The day after my arrival an old servant of my Father's, who in my youth had labored in the fields with me (he was a warmhearted Irishman) his name was Wilson; he came to inform me that a body of men were coming to mob me, and urged me to be on my guard.

I treated this information lightly, but soon after an American *soldier* requested to see me and gave the same account. This alarmed me a little, and I began to think of the best mode of defending myself. At this moment another person announced himself as the Brother of a Lieutenant Hunt of our Army, and wished me to convey a letter to his Brother of my return to New York. Nothing could be more pleasing to me; Lieutenant Hunt was a particular friend of mine. We had fought in the same field together, and we had spent many pleasant hours with each other. I was all politeness to this stranger, shook him cordially by the hand, asked him to take a glass of wine (we had dined). He then asked me if I did not remember him. I answered in the negative. He said that he had been my prisoner; I asked him where. He said at Pound Ridge at such a time and place. I replied, yes, I remember, I came up at a critical moment. "Yes, you no doubt saved my life, but your men had robbed him of his baggage, and I expect you to pay *me* for it." Oh, your most obedient, I find your relationship to my friend Lieutenant Hunt (which you say is your name) amounts only to the price of your baggage. Good-bye to you Sir, I am much engaged, you will excuse me, and left the room, and retired to mine above stairs, and began to prepare for action. Whilst I was engaged with Hunt, my Father had walked out into the street. It was a day of muster day with the Militia, who were just dismissed. My Father soon re-

turned much agitated, and said, "Son, they are really coming and God knows what will be the result." I then desired every person to leave the room. Miss Glover, good-bye, I can die—in no place more honorably than this—you shall see that I can die bravely; I have lived honorably and I will die gloriously; remember me to my Brother Officers. I thrust them all out of the room and shut the door.

Home-coming of American who Fought in the British Lines

In a moment the house was filled with armed men, who demanded to see me. They said, "they did not intend injuring me," but I must "show myself." This was joy to my family, and one of my sisters ran to my room (now Mrs. Hitchcock) desiring me to come down. I desired her to retire and leave me—during this bustle and confusion my Brother had informed a Colonel Jamison (he had a squadron of Dragoons under his command) of the perilous situation in which I was placed, but in the meantime I had complied with the request of my family and went down amongst the assembled mob, some of which spoke in mild and peacable language; others in a very threatening and hostile manner. I however showed a determined and resolute spirit and replied to their demands, that from their declaration I had placed myself in their hands, and that I was now in their power, and if they presumed to injure me that a tenfold retaliation would be made on some of their friends who were then in New York enjoying the protection of the British Army, and pursuing their private business agreeable to the Treaty of Peace, and under the Treaty I demanded the same protection from them. By this time Colonel Jamison had sent a Sergeant and twelve Dragoons with orders to protect me from every insult.

Manuscript of Colonel Jarvis—Born in 1756

Loyalist Mobbed by Townsmen on Night of His Wedding

This circumstance rather checked their hostile disposition, and the authority arriving, I was under no apprehension of immediate danger, yet nothing would satisfy them but an immediate departure from the town, and if I remained during the night I must abide the consequence. The greatest part of the rabble left the house, yet there was several who seemed determined to watch my movements, as if determined to do me some injury. It was at last proposed to my Father that the best mode to quell the mob would be to have our marriage take place that evening, and after some urgency with Miss Glover, she at last consented. A clergyman was sent for, we retired to a room with a select party of our friends, and we were united, after which the mob dispersed and had left us (with our guard of honor) to our night's repose. In the morning however I was again disturbed by a visit from the Sheriff. Hunt had procured a warrant against me for the price of his portmanteau, and the Sheriff had made a forcible entry into my bedchamber. I met him with such a determined and threatening attitude that in his retreat he tumbled from the head of the staircase to the bottom. He then selected a posse—and surrounded the house. My guard had after daylight, returned to their quarters, but were ordered again to return but they again assumed their station inside the house at a proper time for rising. I made my appearance at the window of my bedchamber, spoke to the persons outside, who seemed to look rather ill-natured. I threw them a dollar, desired they would get something to drink the Bride's health, which they did, and before they had finished the bottle I had won them all to my side.

Quelling Irate Patriots by Drinking Health to Bride

"I was a d—d clever fellow; I had got one of the best of women for a

wife in the world; that I was deserving of her, and that they would defend us as long as they had a drop of blood in their veins." Mr. Sheriff seeing this, retired and left me in peace, and we sat comfortably down to our breakfast; soon, however, the mob began to collect in the lower part of the street, and it was advisable that I should leave the place. I, therefore, exchanged my uniform coat for one of my Brother's, stepped out of the back door, crossed the field, where my Brother met me with a horse, which I mounted and rode out of town, and proceeded to the house where I had parted from Miss Glover seven years before, and where she joined me the next day. I remained here but a short time, and then returned to New York, and made my report in writing to his Aid-de-Camp.

Assaults Upon British Sympathizers in First Days of Republic

Soon after this a party of friends from Stamford, Connecticut, and a few in New York, agreed to meet on one of the Islands between those places and spend the day. It consisted of ladies and gentlemen from both places, and myself among the number. We were conveyed in one of our whale boats commanded by a Captain Hubbell; we met our friends, and after spending the day, we were prevailed on to go to Stamford for the night, assuring us that we should not be molested, but in the morning a mob collected, fell upon our boat's crew, beat them unmercifully, and threatened us also, and particularly Mr. William Jarvis (late Secretary of Upper Canada) who was a native of that place. As I was a stranger to them I took the task of appeasing their wrath, and to allow us to go off peaceably, as it was the fault of the people of the place that we had visited them, and particularly as the ladies were much alarmed, and one of them in fits. Our crew had fell down to the mouth of the harbor

An American's Experience in the British Army

and we were obliged to walk, and in many places to carry the ladies in our arms, sometimes in mud and water up to our knees. Soon after we had left the town, they found out that my name was Jarvis also, and Cousin to the other Jarvis, and they swore vengeance at me and set off after us. We saw them coming; we placed the ladies on a dry piece of ground, and prepared for battle. There were five gentlemen of us, Captain Hubbell, two British Officers besides my Cousin and myself. We drew up in battle array and waited the attack. They came within about one hundred yards, when their hearts failed them and they retired. We gained our boat and after being out all night reached New York the next morning at sunrise, but we took care not to let this be known at Headquarters.

An American Soldier's Farewell to his Comrades off for England

In a few weeks after this my wife joined me, and I got quarters in a house at Brushwick, where we remained for about three weeks. I applied for my rations, but as that was contrary to the established rules of the Army, and not receiving any letters from the Paymaster of the Regiment as to how I should draw on him for my pay, I made up my mind to join my Regiment. My wife wished me to take her with me, but I had witnessed too much distress of other Officer's wives, and however painful it was to again be separated, I positively refused. I wrote to my Father, who came down to New York and took her home under his care, and I embarked for St. Augustine. Had I remained one week longer I might have saved myself the trouble and expense of a very long and boisterous voyage, as a gentleman arrived at New York with my despatches necessary for every purpose which was contemplated on my leaving the Regiment. After a passage of five weeks, and the whole time

a gale of wind—I had only to encounter the danger of the sea—I was the only passenger on board. The Master was a very pleasant fellow and the ship was well found, and we weathered the gale, and at last got safe on shore, and when I landed the fleet was in sight to take the Troops on board, as by the Treaty of Peace, St. Augustine was to be given up to the Spaniards. Every preparation was now making for our departure, and about the beginning of October we sailed for Halifax in Nova Scotia, where we arrived after a passage of fifteen days; boisterous weather the whole passage. Here the Regiment was disbanded and their place of destination for the Regiment was Country Harbour, to the Eastward of Halifax, somewhere in the Girt of Canso. Here I took leave of a set of as brave fellows as ever existed, which I had led in many hard fought battles, and who were as much attached to me as children to their Father. So much so when I left them they carried me in their arms to the vessel in which I took my passage for New York.

A British Adherent's Interview With Washington after the War

I arrived at Sandy Hook the day the British Army left New York. The question with me was, shall I, or shall I not proceed; or shall I go back to Halifax? At last I determined to proceed; I must go some time and the sooner the better. So I proceeded to the City and made my appearance at General Washington's Headquarters, and reported myself to General Hamilton. I was directed to call the next morning at nine o'clock. I then began to look out for some of my old acquaintances, but none could I find. All were gone. I at last however fell in with two ladies of my acquaintance, one of them a relation, and after I had engaged quarters for the night, I went and spent the evening with them, and returned to the lodging house, where I found a whole room of mer-

Manuscript of Colonel Jarvis—Born in 1756

chants and other persons from the country. I took a chair and sat down amongst them. They were commenting on the late war, the conduct of their several Generals, and frequently referred to me. I gave my opinion candidly, which by their reply did not accord with their sentiments. I soon called for a servant to light me to bed, and in leaving the room I said, "Gentlemen, I believe you have mistaken my character, I am a British Officer instead of an American!! Good-night," and left the room and retired to my chamber; there were two beds and I made choice of one, and went to bed. I had not fallen asleep, when the door opened and two men in earnest conversation entered, one saying to the other, "d—n the fellow, how he twiged us; who the devil thought him a British Officer; how he got into all our secrets." "Hush!" said the other, pointing to my uniform at the head of my bed. They blew out the candle and went to bed in the dark—never spoke again to my hearing during the night, and in the morning left the room before I was awake—I never saw them after. The next morning at the hour stated I made my appearance, and was introduced to the Great General Washington. He asked me many questions and returned mine with great civility. I asked him for a passport to go into the country. This he refused, having the day before given up his command, but gave me advice how to proceed—I made my bow and retired.

Strong Feeling of Animosity against those who Opposed Independence

After a day or two residence in New York, where I was saluted by the soldiers as some General Officer of theirs, and supplying myself with a stock of tea and sugar for the winter, I left New York and proceeded into the country, and at Reading in Connecticut I found my wife, who had been on a visit at my Brother's for some time. I found her "as women wish to be

who love their Lord." After a short stay, we went to Danbury, where I took up my quarters for the winter. Early in the spring I was again threatened. I took horse and rode to Middletown to see my Uncle, the late Bishop of Connecticut, where I remained for a few days and then returned, but kept myself rather confined. I paid a visit with my Mother to a Brother of hers, a Clergyman of the Presbyterian persuasion. Here we stayed for some time and then returned. I was discovered returning to my Father's and in the evening I got an order sent me in writing to depart or abide the consequence. A few days afterwards a Cousin, also a British Officer, came to pay a visit at my Father's and he was imprudent to appear in his full uniform. We walked out to see a Sister of mine, and after dinner he took his departure. That night my Father's house was attacked, and forcibly entered. I rose from my bed, got my drawers and one stocking on, when I heard the front door give way. I took my pistols and took my stand in the middle of the floor, determined to kill the first man that should approach us. My Father begged of me to flee. I had no time to lose. I flew from one room to another, found all the windows guarded. They had entered the house. They met my Father, knocked him down, flew to my bedroom, turned my wife out of bed, and much injured her. I had no place left but the cellar for safety; to this I fled. My Father recovered his feet, and ran into the Street, he one way and my Sister another, calling out Murder!! Soon the town was alarmed and relief obtained. The Magistrates and others assembled, and after remaining some time in the cellar, the mob dispersed, and I was relieved from my unpleasant situation.

My Mother and Wife suffered much in defending the cellar door before relief arrived. They were black and blue from the blows they received. I dressed myself and went to a friend's

An American's Experience in the British Army

house and went to bed. I was much indebted to a Major Lawrence for my safety. He came armed, brought some others with him, and he had the influence to draw off the mob, and afterwards would not go to his house until he found where I had retired to, and having heard where I had spent the evening, he repaired to the house and found me in a comfortable repose—he then left me. I remained there the whole day, and the next night slept at a neighbor's house a few doors from my Father, and the evening following moved out of town, and took lodgings once more at the place where I fled to the year before, and here I remained until after my wife was confined with her first child, *now Mrs. Phillips*. It was several months before my wife recovered in consequence of the injury sustained by the mob. She came very near losing her life during her illness.

Encounters with Revengeful Countrymen after Close of War

I used frequently to ride over to my Father's in the night and ride back the next evening after dark, and one evening returning I had an opportunity of revenging myself on one of those fellows who had, during the war, abused my Father. I rode alongside of him and with a good hunting whip lashed him every step to his door, and then rode on. He never knew who was the person, neither did I mention it until twenty years after, when I paid a visit to Danbury, and passing through the street saw him and mentioned the circumstance to my Brother. As soon as my wife had so far recovered as to be removed, I took her to my Father's house, where I left her and set off for Long Island. Landed at Cold Spring, where I waited for some days for the arrival of a vessel from New York for St. John, New Brunswick, on board of which I took passage. We put in to Annapolis to land a Mr. Young and his family; stayed two days and then sailed over to St. John, where the Loyalists

had already thickly huddled themselves, and here I met with many of my old acquaintances which I had left at Charleston when I left there for St. Augustine, and here again I met the Officers of the Queen's Rangers, who were about to take up their land above Fredericton, eighty miles up the St. John River, to which place I repaired the first opportunity, which was by a boat belonging to Captain Whillock, of the Rangers, who had taken up his residence at Gage Town, thirty miles below Fredericton, from this I travelled by land most of the way in company with a Mr. Simmons from Staten Island. On our arrival at Fredericton we put up at a small Inn, kept by one Betts, and in the evening two officers came in and remained until a late hour. Mr. Simmons and myself ordered supper and something to drink. We had some moose stake which we found very palatable, and went to bed. The next morning the landlord presented us with a bill, charging us with the supper for the two others, besides all that was drunk, and gave a reason that we had ordered supper and called for spirits, etc. which was drunk. We paid the bill and left his house; before leaving St. John a Lieutenant Hoyt, one of my old Carolina acquaintances, had given me the keys to his house, and desired me to take possession, and remain there until his arrival. I did so, and in a day or two he arrived; with him I stayed until I left Fredericton. I then set about procuring a town lot, and engaged a person to build me a house, and have it ready against the next spring. I then returned to St. John where I remained for some time, and whilst there assisted my relation Mr. Jarvis (who had a hardware store) until my departure. In the meantime, I drew for the first time my half-pay bill, which I got cashed, allowing a discount, of I think, nine per cent. As this was the first period, the merchants were loth to pay cash for half-pay bills.

Manuscript of Colonel Jarvis—Born in 1756

Loyalists flee to Canada to Escape Taunts and Assaults

Mr. Jarvis and his Brother Samuel had a vessel going to New York, and after purchasing a few quintals of codfish I embarked on board of this vessel and sailed, and in passing through Long Island the vessel came to anchor, and landed me and my baggage at Stamford. We had made a short stay at Rhode Island on our way. I landed early in the morning, and after breakfast hired a horse and set off to find my wife. I had got in a short distance of my Brother's when my horse fell and broke his shoulder blade. I took off my saddle and bridle after turning him into a field by the permission of the Owner; took my saddle on my back until I could procure another horse, then rode to my Brother's, changed horses with him and rode on to Newtown, where I had the happiness of finding both wife and daughter in good health. After visiting our friends at Newtown, and paying a short visit at Danbury, I took up my winter quarters at my Brother's in Reading. Here I was very politely visited by all the most respectable people on the place, and amused myself by riding about the country during the winter when I could leave home. In the Autumn both myself, wife and young infant were nearly blind with inflammation in our eyes for a long time, which made our situation exceedingly unpleasant, having no servants to attend us. In this manner we worried through the winter, and when the spring commenced began to make preparations for removing to New Brunswick, and about the 1st of May embarked on board a vessel called the Sholdram, with several other families for the same place. Some of the passengers made it very unpleasant, but as this is not very interesting to the reader, I shall avoid mentioning them, and confine myself to such matters as concern myself and family. On the 15th of June, 1785, I

landed at Fredericton with a wife, one child and a guinea only in my pocket, with one year's half-pay to draw for, and with this I had provided for our future existence. Government allowed the soldiers and refugees three years' rations, and even with the bounty many families suffered greatly for the want of provisions, and had not the forests abounded with moose, many families would have perished. I took with me from St. John a small assortment of goods advanced me by my friend Mr. Jarvis, with which I commenced business, and with this small supply I arrived at Fredericton, but found that the timber of which my house was to have been built was still growing. This put us to great inconvenience, and I was obliged to hire a small hovel, for which I gave ten pounds rent, but here we found it impossible to remain, for the proprietor had during the proceeding winter made a ceiling of slabs and bark overlaid with plaster of mortar or clay, and which he had disturbed in the spring so that every wind that blew our floor was covered with dirt. In this situation we were obliged to live for several weeks before I could possibly find another place to shelter us from the heat. The only difference in the two houses was that we could eat our food without quite so much dirt as in our first habitation. I commenced building, and in October we got into our new house, and thought ourselves as happy as princes.

Life of Exiled Americans under Flag of British Empire

Nothing of any particular interest happened for many years. I went on a progressive way, building and adding to my convenience. I was of an ambitious disposition and fond of Military life, and held during the time I remained in the Providence, from the year 1785 until the year 1809, the following commissions in the Militia, viz., Captain, Major, Major of Bri-

An American's Experience in the British Army

gade, Deputy Adjutant General, and Lieutenant Colonel, independent of the office of Postmaster, and for sixteen years the great part of the summer was employed in disciplining the Militia of the county, without any other remuneration than the thanks of the Governor, with great promises, but his leaving the Province all those expectations failed, and altho I made a good deal of money and acquired some considerable property, I left the Province with the loss of about £3,000, and only brought to Upper Canada a little upwards of Seven Hundred Pounds, with a family of a wife and six children. About the year 1807 an action took place between one of our ships of war and the American ship Chesapeake, and it appeared to me that war would ensue between the two Governments, and I offered my services in case the Militia should be called into actual service, which offer was thankfully accepted, but when it was found necessary to embody the Militia, the command was given to another person. This so far excited my resentment that I immediately made up my mind to quit the Province, and made a visit to Upper Canada. I was well received by the Governor and such promises held out to me that I returned to New Brunswick and commenced closing my accounts and settling my affairs in order for removal the next spring. It was with some difficulty that I could prevail upon my family to consent to emigrate, but after some negotiations between the Secretary of the Province and myself, at the directions of the Lieutenant Governor (Gore) they at last consented and we left Fredericton on the 30th of June, 1809.

We traversed the waters of the St. John in birch canoes, lying on the beach where there were no inhabitants, much disturbed with gnats and mosquitoes at night, and crossing the portage from the waters of St. John to the St. Lawrence, thirty-six miles, most up to our knees, and black flies

to annoy us. We at last encountered all our difficulties, and reached Quebec all in good health, except one daughter who had become the wife of Major Maule of the 104 Regiment, whom I had left behind; after remaining a week, we proceeded to Montreal where we remained one week longer, providing ourselves with such necessaries as would be necessary for commencing housekeeping. We again set off in a battcase for Kingston. We were fourteen days on our passage to Kingston. I applied to the Quartermaster General and was ordered a passage in one of his Majesty's armed vessels, and arrived at New York on the 28th of August, and took possession of a house which had already been purchased for me, and began to make ourselves comfortable. I engaged a public office at £100 per annum until I could look about, and get a location of land, for myself 1200 acres, and for my son, the only one of age, 400, on which he began to improve. The purchase of my house and furniture and the payment of fees for our land had exhausted all my ready money, and I had only my £100 and my half-pay for the support of my family until the Americans declared war against the British Government and invaded Canada.

Experiences during the Second War with England in 1812

There was a young man by the name of Thomas (I dined with him in New York in August 1830) who had been at York for two or three years as a merchant, and who wished to accept of General Brock's proclamation and return to the States. I was recommended to him as a fit person to take charge of his property, for which he was to allow me £125 out of the proceeds, and with which and the other commission business I was enabled to support my family comfortably during the war. I was again appointed Adjutant General of the Militia, and

Manuscript of Colonel Jarnis—Born in 1756

was employed as such until York was taken by the enemy. My ~~children~~ were also in the service, one a volunteer in the 9th and the other at the head of the Waggon Department. The volunteer was taken prisoner at the battle of Queenstown, where General Brock fell. My son was exchanged in a few days and soon after obtained his commission in the 8th Regiment in which he served during the war. Went home with the Regiment and was reduced to half-pay. He was afterwards placed on full pay in the 104th Regiment and returned to half-pay. He is now settled at Cornwall

West Indians of America who Never became Reconciled to Independence

When York was taken and myself a prisoner I was dismissed from my military duty and applied myself to business as a Commission Broker, and I succeeded very well, and had managed in that business only I should have done very well. I am now in possession of £500 in money. I was advised to go to Montreal and open correspondence and commence business on my own account, and if the war had continued I should have done well. I had obtained a credit for any goods that should order. The Peace of 1815 left a very large supply of goods on hand, and the depreciation was of such extent that I was obliged to sell my house and all my real property out of debt, and at the close of war I was reduced to my half-pay only for the support of my large family. At the departure of Governor Gore from the Province, Colonel Smith, an old friend of mine came to the administration of the Province and the Registry of the Home District becoming vacant, he gave me the commis-

sion. This augmented my income to £100 per annum and my youngest son got into the Secretary's Office at £100 and afterwards at £150 per annum, which added together a little more than £300 per annum. He purchased a house and built a comfortable house and we lived together until the year 1805, when his health became declining, and it became necessary that he should change a mode of life. I, therefore, consented to resign my office in his favor, but this was objected to, and he afterwards made a proposal to the Sheriff of the County of York, which was acceded to by the Governor.

I resigned my office, and my son became the High Sheriff. My Daughter has lately married to a worthy Clergyman with a large family. My youngest Daughter is now with her Sister Maudie in France. Her Brother, the Sheriff, allows her the same salary that he allows himself. He is also married and very comfortably settled. I am reduced to my half-pay, and am now moving about from one child's house to another. Am blessed so far with a sound mind and good health, and I hope making preparations for another and better world.

There my fair friend I have given you a sketch of my eventful life, and in doing so I have confined myself to such matter as immediately concerns myself. I might relate many circumstances which were very interesting to myself, but in which you would take no interest, and I fear your patience will be exhausted before you get through these pages. Such as they are, they are much at your service, with this information that they are confined to your own family and those of your friends, and considering my advanced age, you will pardon all its defects.

Nature's Grandeur in America



THE MONARCH "NIAGARA"

Nature's Grandeur in
America—Niagara

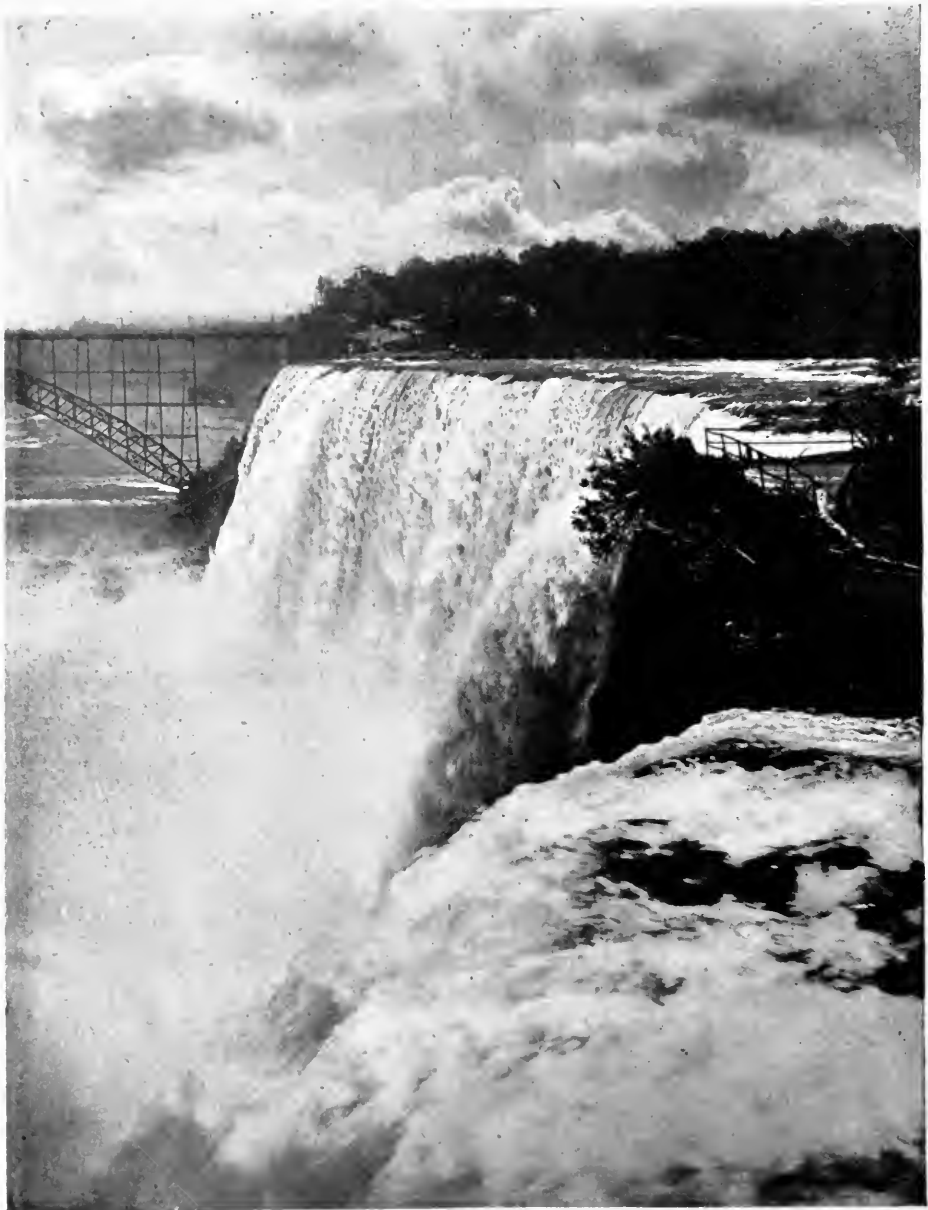

Nature's Grandeur in
America—Niagara



Nature's Grandeur in
America—Niagara



First Fortunes in American Republic

Letters of a
Banker who helped to Establish
the Credit of American Business Houses in the
European Market & Great Commercial Ventures in the Tropics &
Trading Voyages to China & Opening Traffic on the St. Lawrence
River and Lake Ontario & Correspondence of David Parish and Joseph Rosseel

BY

FRANK R. ROSSEEL

BUFFALO, NEW YORK

GRANDSON OF JOSEPH ROSSEEL, THE FINANCIAL AGENT OF THE PARISH ESTATE

IN March, 1906, a large collection of old letters, of great historic value, was found stored away in a chest in the attic of the library building in Ogdensburg, New York.

They were written from 1805 to 1865, but chiefly from 1807 to 1816, and tell of adventures by land and sea; of wars on both sides of the Atlantic; of great commercial ventures in the Tropics; of trading voyages to China in 1807 and to the West Indies and France in 1808; of pirates and shipwreck and capture at sea. They tell of the opening up and settlement of Northern New York and the starting of the tides of commerce on Lake Ontario and the River St. Lawrence, when Utica was a village on the outskirts of civilization and all north of it a vast wilderness. They all bear on the history of David Parish, the founder of the great Parish estate in northern New York, of whom little is known in the United States to-day, although he was a prominent figure in the American financial and social world in the early part of the past century. He was an associate of Gouverneur Morris, General Stephen Van Rensselaer, "the Patroon," John Randolph of Roanoke, Albert Gallatin, General Jean Victor Moreau, Archibald Gracie, the New York banker, and Alexander Baring, of the great English banking house of Bar-

ing Brothers & Company. He represented both Baring Brothers and Hope & Company of Amsterdam, Holland, in the handling of business of vast importance in the Western Hemisphere. He entertained and was entertained by Joseph Bonaparte, ex-king of Spain; he was one of the largest subscribers to the United States government loan of sixteen million dollars in 1813, along with Stephen Girard and John Jacob Astor, who shared seven million dollars.

These recently discovered letters reveal the secrets of the men who helped to establish the credit of American business houses in the European markets. They are also of timely interest in comparing the methods of establishing the first fortunes in America with the financial conditions of just one century later.

The Parish family was a prominent one in Europe when David Parish came to this country in 1806 and took up his residence in Philadelphia, where he was at once recognized as a man of influence and ability. He was then head of the banking and commission house of David Parish & Company of Antwerp and closely related to Parish & Company of Hamburg, Germany, a house established many years previously by his father, John Parish, an Englishman, who, in 1806, was retired and living luxuriously in a beautiful homestead in Neuensteddin, a suburb of Hamburg.

Letters of First American Business Men

The ample means at David's command and his connection with the great banking houses of Europe, enabled him to go into large ventures, and these, owing to his sagacity and attention to business, proved successful, adding greatly to his wealth and reputation. Mr. Parish's father was the first American Consul at Hamburg. Three of David's brothers were associated in the Hamburg house. One of their sisters was married to Hercules Ross, of Rossie Castle, in Scotland. All these men were in daily touch with people high in the service of various European governments and all were excellent correspondents. From them came several hundred of the old letters. They gave David prompt and remarkably full details of every political and military move made in Europe during the Napoleonic wars. Most of them suffered in their own fortunes, and some of them in their own persons, the losses and privations of those trying days, for the Parish family fled in haste from Hamburg on the sudden appearance of the French Army in November, 1806, and the business of the house was, for a time, paralyzed.

Difficulties of First American Financiers in Europe

The war measures of first one nation and then another prevented ships with American cargoes from entering Hamburg, and for some time the business of the house was done at Heligoland, from which place his brother Charles wrote David, August 19, 1809, saying: "I have been here since March and pretty busily employed. American ships come in by droves and which, through your and Baring's interest, mostly are to our consignment."

As the agent of Hope & Company, David Parish managed the difficult enterprise of transferring a large amount of credits to Europe from Spanish colonies in Mexico. The European wars and the consequent

restrictions upon commerce which then existed rendered the navigation of the Atlantic, with valuable cargoes from Spanish or French possessions in the Western Hemisphere, destined to European ports on the continent, extremely perilous. American cargoes, however, could cross the sea and enter certain ports with little danger. The European credits were brought to the United States in Spanish coin and here invested in American produce and shipped to Europe. A good share of these cargoes appear to have found their way to the European markets through the house of Parish & Company. This business necessitated the securing of the specie from blockaded ports by means of smart ships and plucky crews.

In the enterprises in which he cooperated with Baring Brothers & Company, a different course seems to have been pursued, the specie being transferred to England in British frigates. An idea of these operations may be obtained from the following extracts from correspondence addressed to David Parish:

From Baring Brothers & Company, London, 7th of March, 1807.

The "Resistance" frigate arrived safe at Portsmouth on the 26th of February, bringing, it is said, four millions of dollars, obtained under the license granted to Messrs. Gordon and Murphy.

Private letter from Alexander Baring, May 18th, 1807.

I enclose a letter from our mutual friends, Messrs. Hope & Company, covering another for Mr. Villa Nueva at the Vera Cruz, to both of which I request your particular attention, as also to ours to the same gentleman, which I likewise enclose.

It is our present intention to effect the extraction of the sum ceded to us by British ships of war in the same manner as was done by "The Resistance."

It has occurred to me that a couple of your fast sailing vessels may be useful to us in our correspondence between Jamaica and the Spanish ports, and that perhaps they may be useless to you, or at least, that you can spare them for some time. If so, you will send them to our friends, Atkinsons, Hamburg & Company at Kingston. I sincerely congratulate you, my dear sir, on your success. You have certainly been

Founding a Fortune in America 100 Years Ago

fortunate, but good fortune in this instance, as it almost always does, accompanied sound judgment and intelligent measures. . . . At present, we are going on with the receipt of American remittances in defiance of decrees.

From Alexander Baring, London, May 8th, 1807.

We are now completely ready with our operations and expect to start in about a week. My cousin, Mr. Charles Baring, junior, goes out in the vessel. . . . I confirm my request that you will write to him and give him any information you may think of service, without, however, scattering over the seas any useless correspondence.

Magnitude of American Business Abroad a Century Ago

He then refers again to the sailing vessels to assist in the operations and to the necessity for greatest care and secrecy in handling the matter. Referring to the magnitude of the American business, he says he hardly knows of any house but his own "at present equal to transacting with ease the large American operations."

A suggestion of Mr. Parish's part in this particular matter is given in two letters, written evidently by him though unsigned. They are on large sheets of coarse paper, written in a sprawling hand, with great pen erasures, dated Philadelphia, July 10th, 1807, and plainly addressed, one to Atkinson's, Hamburg & Company, Kingston, Jamaica, and the other to Charles Baring, junior, esquire, at the same place, advising both that the "pilot boat schooner 'Champlin,' by the hand of whose captain the letters would be delivered, was at Mr. Baring's service, by order of her owner, Mr. Archibald Gracie, of New York, and that another vessel of the same class, 'The Brothers,' Captain Smith, would promptly follow." He advised Charles Baring of the fact that the "Thames" frigate had not been allowed to remain in Vera Cruz, but was to return next month, "when the bills of which she is the bearer fall due," and suggests that Mr. Baring keep his frigate away from Vera Cruz

until his bills fall due, when she would appear off the port, relying upon the pilot boats to bring the specie out to her. He also says that "R. and I. Oliver of Baltimore may direct Mr. Villa Nueva to ship a considerable sum of money at the same time, provided Mr. Baring is at liberty to receive it aboard the frigate."

Alexander Baring wrote a long private letter to David Parish from the Isle of Wight, dated September 9, 1809, in the course of which he says:

I should have expressed to you earlier, my dear sir, my sense of the very masterly manner in which the whole of this business appears to have been conducted . . . and I can assure you that my experience of the past will always make me see with great satisfaction every opportunity of renewing and extending my connections with you.

Fortunes Founded in Early Real Estate Transactions in America

Soon after his arrival in America Mr. Parish began to consider the purchase and development of a large tract of wild land. The proprietorship of a large landed estate was then thought by many to carry with it more honor than the possession of an equal fortune invested in manufacturing or other commercial business. Wealthy and titled Frenchmen, who had fled from France during the Revolution, had taken up an immense tract in St. Lawrence and Jefferson counties in northern New York, with the intention of building there beautiful homes for themselves. One of the earliest of these was James Le Ray, Comte de Chaumont, known as Le Ray de Chaumont, whose place was in Jefferson county, near Chaumont Bay, at the eastern end of Lake Ontario. Gouverneur Morris and his nephew, General Lewis R. Morris, and the Ogden family were among those earliest interested in northern New York lands. Gouverneur Morris was agent for the Antwerp Company in 1800, a company controlling an immense acreage, and the general purchased

Letters of First American Business Men

50,000 acres in 1804. The home of the latter was in Springfield, Windsor county, Vermont, near the Connecticut river, and his villa on the northern New York property was at the Ox Bow on the Oswegatchie river in St. Lawrence county. Joseph Bonaparte purchased 150,000 acres in 1818 and began to clear for an establishment.

In 1807, Joseph Rosseel, then twenty-five years of age, left his native town of Ghent, Belgium, and came to America, bearing letters of introduction and credit from Hope & Company to prominent people in this country, among whom was David Parish. He appeared on the scene just when Mr. Parish needed a young man of character and intelligence, who was able and willing to endure the hardships incident to exploring the wilderness of Pennsylvania and New York on horseback, on foot and by canoe, and make thereon reports that would enable him to compare one section with another and determine where to establish his estate.

Sixty-Six Days Crossing the Atlantic in Coming to America

Rosseel's journal shows that he arrived in Baltimore and put up at Foulton's Globe Inn, July 30, 1807, after sixty-six days on the ship, which had been held up three times by British men of war. Ten days later he went to Philadelphia and put up at the Mansion House, kept by Renshaw, removing later to Mrs. Kamerer's, 104 Arch street. He said five thousand people were afflicted with influenza in Philadelphia. He seems to have been kindly received and entertained there, meeting David Parish, esquire, among others, on September 26. They soon entered into an agreement whereby Mr. Rosseel undertook to explore the "back country," as he expressed it, in Mr. Parish's interest. The coming of these two men to the United States, their meeting and the interesting parts they bore in the development of the country, are all told most entertainingly in the old letters to which refer-

ence has been made, supplemented by the journal of Joseph Rosseel. Some four hundred of these letters were written by Mr. Rosseel to Mr. Parish, covering the explorations and his intercourse with prominent men of the day incident thereto, and the succeeding years when, as Mr. Parish's trusted agent and highly esteemed friend, he managed the latter's affairs in northern New York, from the time of the first purchase of land in 1808 and the establishment of the commercial house of Joseph Rosseel & Company on the River St. Lawrence at Ogdensburg.

Exploring Wilds of Pennsylvania on Horseback in 1807

Mr. Rosseel started out from Philadelphia on his first tour of exploration December 27, 1807, on horseback, riding in company with Dr. Robert H. Rose, who about that time purchased 120,000 acres of wild land in what was then a part of Luzerne county, Pennsylvania, now included in Susquehanna county—a prominent man who did much for the development of that part of the state. This Dr. Rose and Joseph Dennie, editor of "The Portfolio," were fellow-boarders at Mrs. Kamerer's. This trip carried him through eastern Pennsylvania, as far north as Wilkesbarre, where deep snow turned him back.

On the first of February, 1808, Mr. Parish wrote to Mr. Rosseel, enclosing a letter of introduction to Gouverneur Morris and requesting him to call at the Morris Castle, Morrisania, just north of New York, where he said he would spend a few days with pleasure and profit and meet the governor's nephew, General Morris, who had lands for sale in northern New York. Mr. Rosseel's journal for February 9 says: "Crossed Hudson's river and landed in New York. Took the stage for Harlem Bridge; proceeded to Morrisania, the seat of Gouverneur Morris. . . . Delivered my credentials. . . . Introduced to James Le Ray de Chaumont and

Founding a Fortune in America 100 Years Ago

his son Mr. Vincent Le Ray; likewise to the General Morris a nephew of the governor's—his style of living—romantic ideas which haunted my imagination on my approach of his castle." Referring to this visit, Mr. Rosseel wrote: "I was honored with attention from all. I took notice of the furniture of the castle—rooms lined from top to bottom with expensive glass and a profusion of costly chairs, all French articles, and more especially the plate, on which I noticed the arms of the 'Ferme de Paris.' Someone to whom I related what I saw at Morrisania remarked in explanation that the proprietor of that chateau, who was ambassador at Paris in the time of Terror, had placed in his care for refugees most of their valuables and the owners thereof suffered the guillotine."

He left the castle on the twelfth and after three days in New York started north with General Morris on a long tour, which took him to the lands of Mr. Le Ray as well as to those of the general in northern New York and to the estate of the latter in Vermont, where he was entertained for ten days. Mr. Moss Kent of Albany and Mr. Egbert Ten Eyck of Watertown traveled with them from Albany to Champlain, north of Utica. Mr. Rosseel's comments on people, customs, towns, taverns and scenery are very entertaining. Of Poughkeepsie, he said: "A little town of five hundred houses, five thousand inhabitants; very thriving; supplies this state with East and West India produce." In Utica he "dined with Mr. Van Rennselaer, in 1790 the only habitation in the village. Trade of Utica in European and India goods alone is \$200,000 per annum." Deerfield, Massachusetts, was "neatly cultivated, almost in the European style."

Traveler's Comments on American Cities One Hundred Years Ago

A fellow-traveler, to whom he refers as "a polite gentleman," said of Washington: "The city has the appearance of poverty and misery and

Congress there does not contain one single man qualified for the seat he holds."

In July he started north again from Philadelphia for the Oswegatchie country, swinging a bit to the west on the way. He met Dr. Rose in the wilderness of eastern Pennsylvania and inspected a portion of the doctor's lands. Mr. Rosseel's native tongue was French and while he had gained the ability to express himself quite freely in English with the pen, he still spoke the language with hesitation and uncertainty. Regarding this trip, Mr. Rosseel wrote: "Dr. Rose became very taciturn. His horse had lost a shoe and he rode miles without saying a word. I had learned to keep silence, too, when he was in such a mood, finding that to be a sort of looking-glass for him to see himself and turn away. We ever rode Indian file and he led. The way he would break the silence was often thus: 'Rosseel, do you see those brakes? Well, they indicate cold, strong soil.' And anon he was as amiable and communicative as ever. We parted at Tioga Point and now I reduced to practice his instructions about making inquiries, being frequently at a loss which way to or what distance from such a spot in the woods. Generally, I dismounted, hitched Bonaparte to the fence and walked up to the log cabin, arranging as I went the order of words in which I should inquire the road or distance, which I had stereotyped thus: 'Madame, will you be so kind to tell me which is the road to . . . ?' These words I uttered the moment I passed the threshold of the cabin. The woman stares at me and says, 'Eh?' So I had to go over all those words again—to me a mountain in those days. Dr. Rose, to whom I related it, said: 'Rosseel, always go in and walk up to the fireplace without saying a word to anyone there, waiting till they begin to stare at you and there is perfect silence in the room. Then say, Madame, which is the road to . . . ?'"

Letters of First American Business Men

Experiences on a Trip Through New York State in 1807

Not far from Ithaca, New York, he was lost in the woods and overtaken by a hurricane that uprooted the largest trees. Of Ithaca, he said: "This village contains but a small number of houses, in the building of which nothing has been omitted but the comfortable and the agreeable." The following description of a stretch of country between Ithaca and Milton of the "Ferme de Paris." Someone shows that the "back country," even in 1808, was not all wilderness. "I now traveled on the highlands, commanding two fine prospects of a very extensive wild, intersected with a few clearings to the east, the levelness of which is like the surface of the lake to the west. The highlands are beautiful, rich and healthy, along the very best of roads. There is hardly an acre of unimproved land visible. It is but one continual garden. Nothing is to be seen here but fields of every kind of grain the earth produces; fine farms succeeding each other very closely, well-stocked with cattle, horses and pigs, besides fine and large orchards of fruit and numerous springs of delectable water are scattered along the way." There is no mention of a village called Syracuse, but he describes the pumping and evaporation of salt water at the "Salina," and says the product was exported "even to Pittsburg." A three hundred pound barrel sold at the works for two dollars. The barrel cost half a dollar and the state collected four cents per bushel. It seems that there were times when he could not say "No," for he writes: "I stopped at Oneida Castle and was much annoyed by the Indians. They would have me drink whiskey and gin with them, nor was it in my power to deny them." There was but one white family who entertained travelers. Having supped with them, Mr. Rosseel sat beside the door smoking his pipe, when a circle of Indians and

squaws gathered about him talking loudly. After his host had explained what they said, he handed over his pipe, which was passed around the circle, each one taking a few puffs. It was then that they would have him drink with them. From August 8 to September 18, he was inspecting the north country, sometimes alone and sometimes with a guide. A Dr. Townsend owned the village of Gouverneur in St. Lawrence County, where he resided. Having a severe toothache and there being no other physician nearer than Sackett's Harbor or the Garrison (Ogdensburg), Mr. Rosseel went to Gouverneur, meeting the doctor about a mile from the village, carrying a log chain on his shoulders. His appearance and his awkwardness in handling the forceps, when they arrived at his house, were anything but inspiring, and when, after a savage pull, the tooth broke, Mr. Rosseel fainted. The doctor then "killed the marrow" with oil of vitriol, the pain from which was "indescribably acute for a time," but which effectually prevented further trouble.

Society in America in the First Years of the Republic

The Morrisises, the Ogdens, Mr. Constable and Mr. Pierpont were all in that country, hovering between Le Ray's place and General Morris's. Mr. Parish, who had been on a trip to Niagara Falls, with his friend, General Moreau, arrived on September 7. Several days were then devoted to entertainment, hunting and racing, with music and fireworks at night. Mr. Le Ray's wife and daughter and General Morris's wife contributed to the pleasure of these festivities. Mr. Rosseel participated in the entertainment but did hard woods work also, as the following quotations from his journal will show: "September 15th took my old guide, Mr. Rockwell, and started in the woods again exploring Indian River. 16th, built a raft; crossed the river; difficulties; encamped; out of bread;

Founding a Fortune in America 100 Years Ago

no water; collecting of the rain; three times our fire extinguished; cold uncomfortable night; sat squatted under my blanket; 17th, hungry, thirsty, cold and wet; proceed in the exploration; fell in with an immense swamp; every step knee deep; the weather still boisterous with heavy rain. At 2 in the afternoon came to a camp; found bread but no water; proceeded much annoyed with thorns and briars; made a creek; arrived at Morristown (10 miles above Ogdensburg on the St. Lawrence) and met Mr. Parish who was on a hunting trip." The next day Mr. Parish and Mr. Rosseel visited Ogdensburg, accompanied by the two Morrises, and tentative plans were made for an establishment there.

First Land Speculations Along American Frontier

Mr. Parish purchased large tracts of land in St. Lawrence and Jefferson Counties from Mr. Le Ray and General Morris in the fall of 1808, to which he later added other tracts. One of the first purchases was 72,000 acres at one dollar and fifty cents per acre. Final arrangements were made between Mr. Parish and Mr. Rosseel at the Tontine Coffee House, in New York, October 24, 1808, for an "establishment" at Ogdensburg. Mr. Rosseel and his partner, Mr. David M. Lewis, had David Parish's backing in the commercial house of Joseph Rosseel & Company. To bring their large stock of goods from "civilization" was no light matter, and the "no-intercourse" acts, which preceded by several years the War of 1812, cut off their trade with Canada. The lands had to be inspected and surveyed; there were roads and bridges and saw and grist mills to be built and the mills to be operated; but the plans, to the execution of which Mr. Parish requested Mr. Rosseel to give his first and chief attention, were the building at Ogdensburg of a large mansion for himself, a large store and warehouse and two schooners to ply

on Lake Ontario. New York, Philadelphia, Albany, Utica and Montreal were searched for mechanics and laborers to go to Ogdensburg. Under date of May 15, 1809, Mr. Rosseel said in a letter to Mr. Parish: "We have to make great allowances for the novelty of a colony where erecting buildings is like creating a new world, where workmen are destitute of tools and the country devoid of materials."

Overland Transportation to Canada—"Every Man for Himself"

From New York men and materials could come to Albany by water. From there a stage ran to Utica, in which one might ride if he secured passage in time; but from Utica, north, it was "Every man for himself," through forests and streams, by crude roads, often all but impassable. It was probably well on to one hundred and fifty miles from Utica to Ogdensburg by the land routes then followed. Freight usually went to Oswego and thence to Ogdensburg by water. Mr. Rosseel made two trips to Montreal for laborers, going once in December, 1808, by sleigh, down the frozen river, making the one hundred and twenty miles in three days. At another time, he sent twelve laborers from Montreal to Ogdensburg in a boat purchased for the purpose. They were to receive \$13.50 a month and a blanket. When ready to return from Montreal, he was fortunate enough to receive an invitation from a "gentleman of the Northwest Company" who was "on his departure for Michillimacinae" to accompany him in his canoe as far as Ogdensburg. The woods were scoured for miles about Ogdensburg for timber for the schooners. None but the best was to be used and many trees were felled before satisfactory material in sufficient quantities could be accumulated. Good red cedar for planking was found among the Thousand Islands and rafted down to Ogdensburg. If Joseph Rosseel did

Letters of First American Business Men

not lose his temper while these building operations were on, he must have had remarkable self-control. His laborers left him for the lumber woods in Canada; a great gale, with unprecedented high water, flooded the foundation trenches for the big warehouse, and he wrote on the fifteenth of May, 1809: "They are now busy in boiling the planks for the vessels. I am sorry to say that he who sawed these planks, although the best mill attendant, understand the business not very perfectly. The dimensions are very irregular. Some planks are three inches, while others are but one and one-half inches thick." These are but samples of the difficulties by which he was beset on every hand.

Establishing an American Fortune on Northeast Borders

After unnumbered trials and delays, the mansion was built of brick, made for the purpose in the village, and the large store and warehouse was constructed of stone on the bank of the Oswegatchie, where it empties into the St. Lawrence. The sails and rigging for the schooners, costing thirty-six hundred dollars, were brought from New York. The large one, called "The Experiment," was of fifty tons, six and one-half feet draught; the other, "The Collector," of forty-four tons. The "Experiment" was finished first and her launch was one of the features of the Fourth of July celebration in Ogdensburg in 1809.

First Commercial Enterprises Along the St. Lawrence River

The following is Mr Rosseel's report to Mr. Parish of the events of the day: "The anniversary of the Fourth of July was celebrated with much more spirited rejoicings and diversions of every description, more brilliancy, and above all, more decorum, than ever was before. You will no doubt hear of it before long, for the gentlemen of the committee have resolved on giving all publicity to the

celebration. On that day your vessel, the 'Experiment,' was launched with unexpected success. It was a beautiful launch, witnessed by upwards of four hundred spectators. There was a public dinner to which ninety-six persons sat down. The Honorable Judge's voluntary toast was: 'David Parish, esquire. May his commercial enterprises be as successful on the St. Lawrence as they were on the ocean.' Three cheers and a salute. I happened to visit this table with some of our Canadian friends, when General Lewis R. Morris, who was one of this convivial party, gave the following toast: 'Our neighbors of Canada. Under the liberty of a mild government, may our friendship with them last as long as the St. Lawrence.'"

Early in 1809, Mr. Parish purchased the village of Ogdensburg from David B. Ogden for eight thousand dollars. Only thirty-eight lots therein had been sold up to that time. Smuggling operations, when successfully carried out, were very remunerative and the Collector of the Port of Oswego, in which district Ogdensburg was included, was suspicious that Joseph Rosseel & Company intended to break the law. He held up a shipment of three hundred and fifty barrels of salt for them until Mr. Gallatin wrote him, at Mr. Parish's request. The latter soon succeeded in getting Ogdensburg made a port of entry.

Development of Traffic on the Great Lakes

Other schooners, built a little later in Ogdensburg, joined the "Experiment" and "Collector" in the traffic with Lake Ontario ports, encountering the opposition of vessels owned in Kingston, at the foot of the lake on the Canadian side, and others owned by Porter, Barton & Company of Lewiston on Niagara river. Those of the last-mentioned firm would carry one thousand barrels each. Ogdensburg was the foot of naviga-

Founding a Fortune in America 100 Years Ago



A PIONEER IN TRADE WITH CANADA—Joseph Rosseel who came to America from Belgium in 1807 and became one of the Leading Business Men of the New Republic—Old Photograph now in possession of his descendant, Frank R. Rosseel of Buffalo, New York—Reproduced by permission

tion for lake vessels and produce was there transferred to smaller vessels, "scows" or "arks," for shipment to Montreal. In 1810, freight was one dollar per barrel on flour from any Lake Ontario port to Montreal.

Early in 1809, Mr. Rosseel began to report on the scarcity of flour, wheat and other agricultural products, the settlers having neglected agriculture to make staves and potash for the Montreal market. In November of that year, the situation had grown serious. Winter had shut in unusually early and severe and Ogdensburg and all the surrounding country was in a state of famine. The schooner "Experiment" was known to be on her way down Lake Ontario loaded with provisions for Ogdensburg. On November 24, Mr. Rosseel wrote: "We have no wheat at all. Most people live on Indian corn. . . . Should the schooner now be

taken on the ice in some bay or harbor on the Ontario, and not be able to proceed with her cargo to this place, in that case Ogdensburg and its vicinity will, during this rude winter, offer a dismal picture of human miseries. People now come twenty and thirty miles after flour, wheat and pork. All the stores are unsupplied and the barns empty. They all depend on the schooner for their supplies.

Money also was scarce and Mr. Rosseel was considering a horseback trip to Albany for a supply. His funds often came to him from Mr. Parish in Bridgeport bank notes, by the hands of whatever trustworthy person happened to be coming North recently. To add to the misery of the people, "the worst storm ever known on the St. Lawrence" visited them early in December. It is safe to say that the "Experiment" received a hearty welcome when she arrived December 22d.

The country settled slowly. In November, 1809, there were five reg-



AN EARLY AMERICAN BANKER—David Parish who came to America from Antwerp in 1806 and established a great foreign trade with the New American Republic—Miniature painted on Ivory by Spornberg in Chettenham, England during 1810

Letters of First American Business Men



George Parish, the second, afterwards Baron Von Senftenberg of Austria, who occupied the Parish Mansion in America—Photograph presented by the baron to an intimate friend residing in New York

ularly established stores in Ogdensburg. In July of the next year, eight new houses were building there, besides Mr. Parish's mansion, and in May, 1811, the number of houses in the village did not exceed fifty.

Other villages, Antwerp, Parishville, Rossie, developing on Mr. Parish's land, necessitated the appointment of sub-agents, responsible to Mr. Rosseel. At Parishville a sheep-farm was established, where merino sheep were tried in 1813 and 1814. Iron ore had been found on Mr. Parish's land and a furnace started at Rossie under the supervision of William Benbow, in time to make it possible for Mr. Parish to bid on cannon balls for use in the War of 1812-14. Mr. Parish had furnished the money to start the firm of Borrekens & Hoylarts in Sodus, on the southern shore of Lake Ontario, expecting they would work in conjunction with the Ogdensburg house.

The Canadian side of the St. Lawrence, opposite New York state, had been settled by Tories from the states previous to the settlement of the south shore. When the first Americans came they were welcomed by their neighbors across the river and the best of feeling existed when the hostilities of 1812 began. The war was unpopular along the river. Some of the troops sent to Ogdensburg were of such a character that the inhabitants feared and hated them almost as much as they did the Indian allies of the British, who, while doing sentry duty on the frozen St. Lawrence between the villages, frequently landed on the American side, committing depredations and keeping the women in a state of panic. Ogdensburg people felt relieved when the American soldiers departed and when more appeared a large part of the population always prepared to "take to the woods." In a letter written in April, 1809, Mr. Rosseel referred to the troops then in Ogdensburg as "a banditti of rapsallions, who, by nocturnal excursions in our village, carry off pigs, geese, chickens, potatoes, onions and every other eatable they can come at." This garrison consisted of two companies sent there to enforce the embargo law. When they left town for another station, the villagers were so delighted that they saw them away with tin horns and cowbells, and a free fight was narrowly averted.

A party from Ogdensburg raided the Canadian village of Brockville, twelve miles up the St. Lawrence, on the night of February 6, 1813, for the purpose of releasing prisoners. In retaliation, seven hundred British troops attacked Ogdensburg a few days later, crossing the St. Lawrence on the ice, early in the morning from Prescott. They captured Fort Rensselaer easily and drove the ill-disciplined little garrison back through the village. About the close of the fight, Indians and roughs ran-



MANSION BUILT IN THE "WILDERNESS" OF NEW YORK IN 1800—Built at Ogdensburg by Joseph Rosseel for David Parish—Ancient photograph shows George Parish, and at the left, talking with John F. Rosseel, financial agent, and Judge William C. Brown—The old gentleman with the tall white hat is Edward Beaty, the mansion cook, conversing with William Houston, gardener—Original owned by Frank R. Rosseel

sacked all houses from which the owners had fled. Mr. Rosseel and a few others sent their families away but stayed by their homes. The marauder's seized some of Mr. Rosseel's property and were dragging him away when a British officer with whom he was acquainted came along and released him. All the public property was taken. Many houses were badly shattered; the barracks, the old garrison, the vessels in the harbor burned and Fort Rensselaer was destroyed. Comparatively few lives were lost. Mr. Parish's property was not molested but all the windows in the mansion were broken by concussion. This little unpleasantness did not interfere with the "neighboring" of old friends and acquaintances across the river and the British officers spent considerable money in Ogdensburg stores.

Early in November, 1813, the American army composing Wilken-

son's expedition against Montreal passed down the St. Lawrence. On account of the danger of passing Fort Wellington in Prescott, the men were landed about three miles above Ogdensburg and marched to a point about the same distance below, in the night, the ammunition and other supplies going in wagons. Meanwhile, the three hundred boats were silently slipping by in single file, and although discovered by the enemy and subjected to a furious cannonade, little or no damage was done to the flotilla.

During the war Ogdensburg was shelled several times. Mr. Parish's influence was always exerted in the direction of maintaining good relations with the opposite shore and he bitterly opposed the petty raiding and what he considered rash conduct of some of the American officers.

In 1812 Mr. Parish sent Mr. John Ross, a nephew, to live for a time in Ogdensburg. Ross brought with

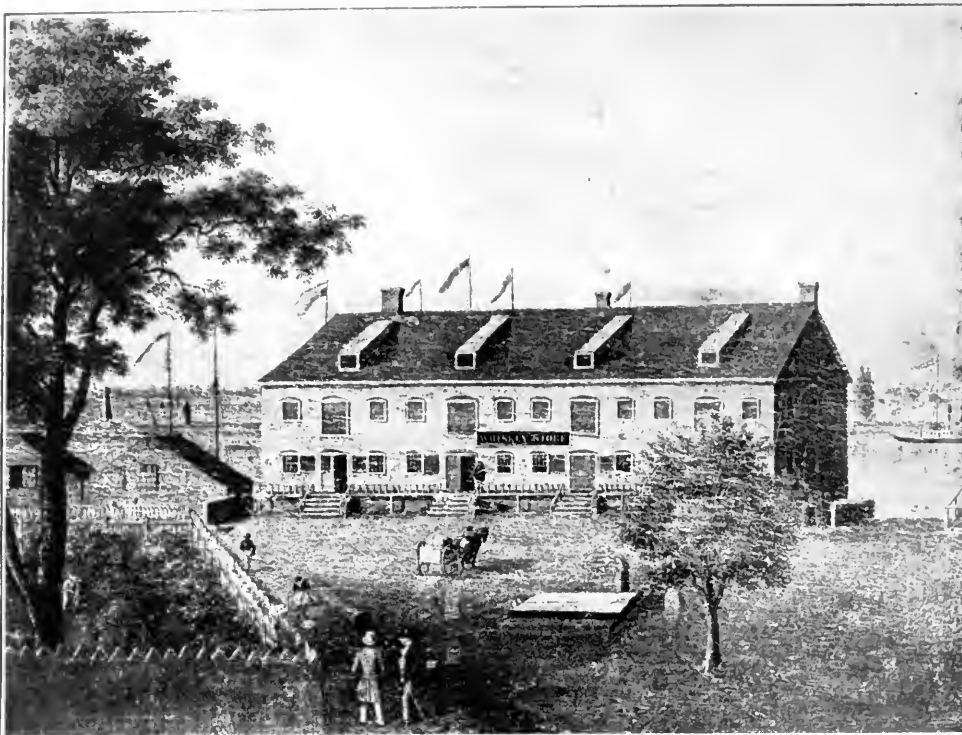

ONE OF FIRST WAREHOUSES ON ST. LAWRENCE RIVER—Constructed by the Pioneer Joseph Rosseel for the shipping interests of David Parish—Old Lithograph in possession of the descendants—The ancient "stone store" is still conducting trade with Lake Ontario and Montreal—Reproduced by permission of Frank R. Rosseel, Buffalo, N. Y.

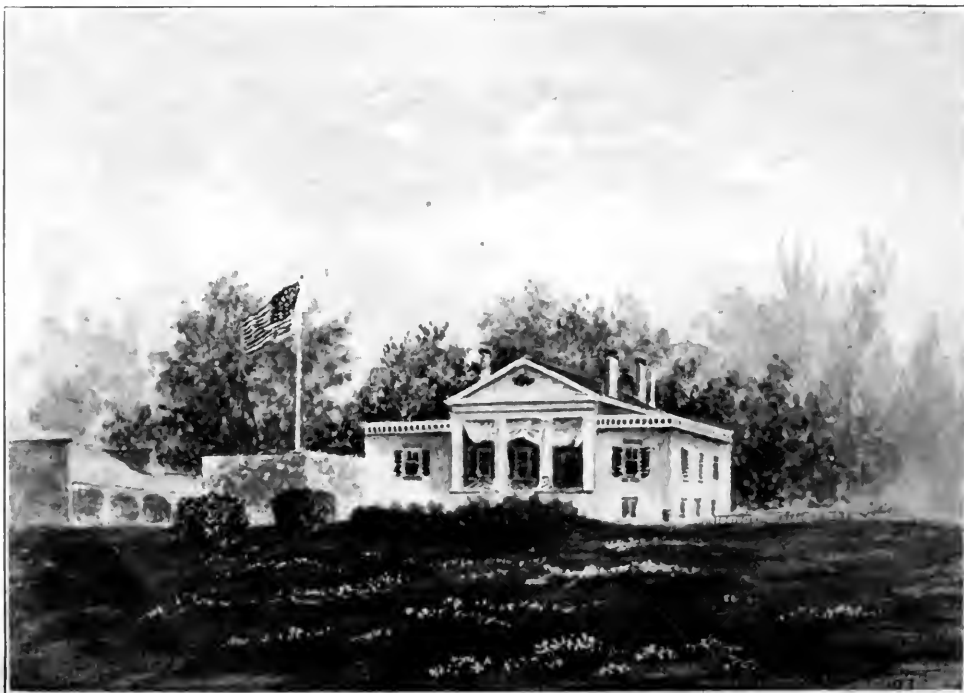

HOMESTEAD OF A PIONEER ON THE ST. LAWRENCE RIVER—Built by Joseph Rosseel, the financial agent of David Parish whose mansion stood on the opposite side of old Washington Street in Ugdenburg, New York—Painting by Frank R. Rosseel, grandson of the builder—This view shows the back piazza which faced the St. Lawrence

Founding a Fortune in America 100 Years Ago

him from Philadelphia a blooded mare of Mr. Parish's, riding the animal from Philadelphia to New York and from Albany to Ogdensburg. He had an eye over Mr. Parish's domestic affairs, his horses and dogs; but I suspect his chief duties were of a secret and quite different character. At any rate, he was a diplomat. He secured the confidence and good-will of the British Colonel MacDonnell, in command across the river, and often dined with him, meeting other officers, all of whom he cultivated. Mr. Parish gradually came into the acquaintance and soon they could ask favors of the British officers with an assurance of their being granted. It all led up to the protection of Mr. Parish's property from British attack. That favors were asked and granted in return is shown by the following extract from one of Mr. Ross' letters to Mr. Parish: "General Drummond sends his compliments and will acknowledge it a very particular favor if you will exert your powerful influence with the government to get his aide-de-camp, Captain Loring, released, exchanged or paroled." Very soon thereafter Lieutenant Webster, a severely wounded American officer, on his way to Quebec as a prisoner of war, was voluntarily sent across the St. Lawrence to Ogdensburg, on parole, until authority could be obtained to do more, as a token of appreciation of Mr. Parish's kindness. Many of the American vessels on Lake Ontario and the St. Lawrence river were bought by the American government, armed and re-named and put into active service as war vessels. Among them were the "Experiment" and "Collector," re-named "Growler" and "Pert."

Mr. Parish visited Ogdensburg frequently, spending considerable time there and living in grand style, with many servants, horses and dogs; but continued his headquarters in Philadelphia, which, in 1808, were at 153 Walnut street. Here Joseph Rosseel visited him in the spring of that year,

Mr. Parish making his stay very pleasant. Writing of it, Mr. Rosseel said Mr. Parish took him to Mr. Hamilton's on the Schuylkill, where he and the élite of the city were in the habit of dining on certain days of the week. In January, 1812, Mr. Parish wrote from Albany that he was so far on his way to Ogdensburg, coming in a sleigh behind his own horses, accompanied by a friend and two servants. In his story of that north country in 1813, entitled "Dri and I," Mr. Irving Bacheller tells of David Parish's driving through that region at high speed with frequent relays of horses.

A billiard table arrived in Ogdensburg for Mr. Parish in 1815 and Mr. Rosseel was compelled to send to Montreal, one hundred and twenty miles, for a man to set it up.

Strong Character of an Early American Money-maker

About a hundred letters were from David Parish himself to Joseph Rosseel. They show he possessed a thorough knowledge of all that transpired in the development of his affairs on the St. Lawrence and that he took a keen and kindly interest in the welfare of all of his employees and settlers, advising, commending, encouraging, advancing money and extending time to those overtaken by misfortune, though not easily imposed upon, patient when the execution of his plans were delayed or foiled by the innumerable difficulties under which Mr. Rosseel labored, liberal in his contributions for the public good; keenly interested in the development of the country and quick to see and take advantage of the course of events political and commercial. Through his letters to Joseph Rosseel the inhabitants of Ogdensburg received their first news of many of the important political moves on both sides of the Atlantic. In many ways he was a father to the north country and as such was held in high esteem. He was a broad-gauge, kind-hearted, lovable man, evidently possessing great

Letters of First American Business Men

business capacity and keenly enjoying the making of money; but his wealth, power and influence did not make him hard-hearted or grasping or indifferent. With all his vast interests he found time continually to do favors both great and small for all kinds of people. His employees loved and respected him; his younger sister idolized him and with him his dear old father shared all his confidences, addressing him, "My dear and ever dearest David."

Diplomatic Society in National Capital at Washington

Mr. Parish had many acquaintances among public men in Washington, where his influence was very great. For many months during the years 1813-4-5, Edward Ross, a wide-awake and winning, but at times dissipated young friend of Mr. Parish's, resided in Washington and kept David continually informed regarding what was transpiring. He was very intimate with General Armstrong and Colonel Monroe while each was in turn Secretary of War; also with Secretary Dallas and with the families of all. He acted as private secretary to General Armstrong and dined daily with senators and congressmen. He had, and conveyed promptly to Mr. Parish, advance and private information of many important matters. Mr. Parish's letters to him were eagerly read by members of the cabinet, who depended much upon them for the latest and most reliable news from the north and from Europe. He was "one of the family" wherever he chose to be in Washington. Even President Madison's wife interested herself to secure for him a commission in the army. He was a younger brother of John Ross, "the diplomat" at Ogdensburg. In 1807-8 he acted as supercargo on ships trading from the United States to China and to European and West Indian ports and from him came the letters telling of "pirates, shipwreck and capture at sea." This was in the days when lit-

tle sailing vessels cruised half-way round the world, carrying a fortune in gold or silver coin, with which to purchase a return cargo of teas, silks, nankeens and other interesting products of the far East. They were all armed, but trusted chiefly to speed and good seamanship to escape pirates and vessels of war. I give below extracts from a few of the letters written by Mr. Parish from Philadelphia to Mr. Rosseel in Ogdensburg.

January 2, 1810.

You will be astonished to hear that our friend, Mr. Gouveneur Morris was married on Sunday to Miss Randolph of Virginia, who had lived in his house for eight months in the capacity of housekeeper. She is of a very respectable family and I sincerely wish he may enjoy every domestic happiness and comfort.

January 29, 1810.

I understand from Mr. D. B. Ogden, who is now in this place, that the Federalists will have a majority in the council of appointment and that it is their intention to elect Colonel Troup mayor of the city of New York, an office now worth fifteen to twenty thousand dollars per annum.

April 7, 1813.

Mr. Gallatin has been here for some days past and I yesterday made an arrangement with him for the balance of the loan, being between seven and eight million dollars. If I had not calculated on an adjustment with England I should not have entered into this operation.

He said in the same letter that by order of the Secretary of the Treasury he had written Commodore Chauncey at Sackett's Harbor, offering to deliver a few hundred tons of cannon balls at Ogdensburg at eighty-five dollars per ton.

April 15, 1812.

Have been for last week and continue to be engaged in important business at court in an action brought against me by Ferdinand the 7th, as King of Spain, claiming a large sum of money for duties on exportations to South America.

May 3rd, 1816, he wrote:

The Spanish suit was decided in my favor two days ago after a most able charge to the jury by Judge Washington. The claim made by the King of Spain amounted to upwards of a million dollars.

Founding a Fortune in America 100 Years Ago

In 1810 Mr. Parish returned to Europe, remaining several months. In Amsterdam and Antwerp he met Mr. Le Ray and they held earnest discussions on the subject of road building in northern New York. It was while visiting his father in Cheltenham, England, on this trip that the miniature reproduced on another page was painted.

The following letter was received by Mr. Parish in 1809:

PARIS, 14 APRIL, 1809.

SIR:

I take the liberty of introducing to your acquaintance the Chevalier de Dashkoff, Charge d'affairs and Consul General of His Majesty, the Emperor of All the Russias for the United States. He proposes residing at Philadelphia with his amiable family. His rank and situation and diplomatic character, and above all, his excellent qualities and great merit are sure to gain him the esteem and friendship of all those who have the satisfaction of becoming acquainted with him. I take, therefore, a peculiar pleasure in recommending him to your particular notice and civilities, persuaded that Mr. Dashkoff will be kindly and hospitably received.

I should be extremely happy if I could be of any use to you in this country and beg of you to dispose of me in whatever shape you may think proper.

I have the honor to be with great esteem, Sir,

Your obedient humble servant,

HENRY ESCHER.

DAVID PARISH, ESQ.,
PHILADELPHIA, PA.

Personal Confidence of the First Prominent Americans

David's brother, John, said in the course of a letter dated Senftenberg Castle, 10 September, 1815: "I have become the proprietor of a principality of considerable extent and which henceforth will have my undivided attention an time to make it in some measure what it is capable of becoming. . . . I have a town and twenty villages, with about fifteen thousand subjects."

This was in Bohemia, Austria.

Mr. Parish's young friend, Edward Ross, had relatives among the wealthy Virginia planters. The following extract is from one of his letters to Mr.

Parish while living among them. It was written from Mount Ida, near New Canton, Buckingham County, November 23, 1813.

I have to acknowledge receipt of your much esteemed favor of 1st instant. I would most certainly have answered the same much sooner, but this letter was kept here with several others until my return from Monticello, where I have been for some time, and was much delighted with the very friendly and hospitable reception I met with from Mr. Jefferson. What strong impression his amiable granddaughter, Miss Randolph, has made upon my heart is impossible to describe, and between you and me, I have some reason to believe that she is not altogether indifferent to what regards me. I shall follow your good advice, discard all foolish ideas of Clara, of returning to Philadelphia and upon my honor will entirely mend and turn my mind to more useful occupations. I shall neither for the future trouble you any more with these nonsensical details of my hunting parties, feasting etc., for I have given all this up and my hounds run about in the yard neglected, my horns hang on the wall without being touched and even Powhattan I have not rode ever since my return from Monticello, where I intend very soon making another long visit, as Mr. Jefferson particularly begged me to do so and appeared to have taken a great liking to me, for he did ride every day out with me, did show me all his mills, farms, machineries, curiosities, &c. He conversed with me about politicks all day long and about Europe and many other countries.

In these days of stenographers and typewriters, of haste and rush in correspondence, it is a treat to read the letters exchanged by Mr. Parish and Mr. Rosseel almost a hundred years ago, personal letters written with quill pens on generous sheets of paper. As a sample, one of Mr. Parish's opens: "Since writing to you on the 2d instant, my dear sir, I am deprived of the pleasure of hearing from you," and closes, "I am always, with true attachment, my dear sir, Yours sincerely, David Parish." The following quotation from one of Mr. Rosseel's to Mr. Parish might be considered "a special effort." It closed a particularly interesting, descriptive letter, written at Montreal, December 30, 1808:

On the occasion of the renewal of the year, I offer my compliments by anticipa-

Letters of First American Business Men

tion, that it may be for you, dear sir, happy and prosperous, is the object of my unfeigned wishes, and to find out the opportunity of rendering my existence subservient to your interests is the object of my solicitude. I remain unreservedly and respectfully, Dear Sir, your most devoted, faithful servant, Joseph Rosseel.

His next letter from Ogdensburg closed:

I have not time to say more. Judge and Major Ford present their respects to you. Accept of mine with the assurance of my attachment. Your faithful servant, Joseph Rosseel.

Mail Service in America One Hundred Years ago

And the mail service of those days was most remarkable. In 1809 the government mails were four weeks in going from Philadelphia to Ogdensburg, and the carrier *started back in two hours*. There does not appear to have been any regularly established public trans-Atlantic mail service. In May, 1810, Mr. Parish, who was on the eve of departure for a trip to Europe, wrote Mr. Rosseel, saying that he would expect him to write once a month, addressing him care of Baring Bros. and Company, London; "originals" to go to Messrs. Archibald Gracie & Co. New York, and "duplicates" to Mr. George Harrison in Philadelphia, "opportunities for England being frequent in both places." In other words, the letters were to be sent by government mail to Mr. Parish's friends in New York and Philadelphia who would find some private opportunities to get them to London. Letters were written to friends across the water and held in readiness to be entrusted to the care of the first traveler about to cross the sea. It is probable that most merchant vessels carried a mail bag for the accommodation of friends of her owners. Letters were written in duplicate always and sometimes in triplicate, each being dispatched by a different opportunity. One letter from his relatives in Scotland to John Ross in Ogdensburg was nine months on the way, passing from hand to hand.

David's father would write him, sending a copy of the letter to another son, who would add a few lines and forward. If one letter failed to reach destination, better fortune might attend the other. Neither envelopes nor postage stamps were then in use.

Difficulties of Communications in 1807

Letters were folded snugly with one end slipped into the other, to about three by five inches and sealed with wax. These passing through the United States government mails bore a postmark as now, and the amount prepaid for carriage was marked on with a pen. Twelve and a half cents seems to have been the minimum postage, as ours is now two cents, and it often ran up to two and three times that amount.

The isolation felt by the residents of the St. Lawrence may be imagined from the fact of their referring to the cities on the sea board as "in the states."

April 19, 1816, Mr. Parish wrote to Joseph Rosseel:

Having entered into an arrangement with my brother George, by which he becomes interested in all my land concerns, he will take up his residence at Ogdensburg and have the general superintendence of all my business in the state of New York. Your agency will continue, if you are so disposed and I have no doubt the same harmony and good understanding will exist between you and him as has hitherto prevailed between you and me.

David Parish died ten years after he returned to Europe, that is, in 1826, and the following year his brother, George, came into possession of the entire estate which he retained until his death in 1838 or 1839. Joseph Rosseel was the sole executor of his will. In 1839 the estate was purchased by the "2d George Parish," a nephew of the former proprietor, for two hundred and twenty-nine thousand dollars. He was the son of Richard Parish and an Austrian baron. All three of the Parish proprietors were bachelors.

Founding a Fortune in America 100 Years Ago

Joseph Rosseel continued to act as agent for the Parish estate until retired with full pay for the balance of his life by the "2d George" in 1859, when he was nearly eighty years of age.

Discovery of the Ancient Manuscript in Old Mansion

The Ogdensburg Library, in the attic of which I found the old letters, stands on the foundations of the Rosseel homestead, built by Joseph Rosseel; an old-fashioned, wide-spreading house with white, rough-cast walls. Deeply recessed piazzas, front and back, with high Grecian columns, were connected by a wide hallway. One faced the St. Lawrence, here a mile in width, and commanded an unobstructed view of seven miles of the Canadian shore, the grassy walls of old Fort Wellington being directly opposite. The other looked out upon the Parish mansion across the way. A fountain played in the front yard among syringas and honeysuckles. Locusts and horse-chestnuts shaded the house and the sidewalks in front. Carefully tended flower and vegetable gardens and vine-clad arbors lay between the house and the river. Here Joseph Rosseel died in 1863.

Up to about 1880, when the remnants of the estate were sold, the Parish mansion remained much as it was

when occupied by the "2d George," a large, three-story brick structure, painted a deep-red, standing in a little forest of trees surrounded by high walls and fences and facing upon a circular grass-plot in the middle, with its back turned to the people of Ogdensburg.

The Home of One of America's Early Financiers

Thus I recall it when, as a boy, I was on special occasions allowed to wander through the darkened rooms, over thick velvety carpets, while the caretaker opened here and there a shutter, letting the sunlight stream over costly furniture and rich hangings. The "2d George" paid his last visit to it about 1865.

The Rosseel homestead, full of dignity and hospitality, is gone, and with it the rows of locusts, the syringas and honeysuckles, the fountain and the vine-clad arbors. Across the street, the little forest of trees, the high walls and fences have long since disappeared, but the Parish mansion, somewhat remodeled, still stands and shelters one of Ogdensburg's most prominent citizens, who also occupies the "old stone store" on the river-bank for the transaction of a forwarding business, his fleets sailing on Lake Ontario and away north to Montreal as did the tinyschooners and the "arks" of 1810.

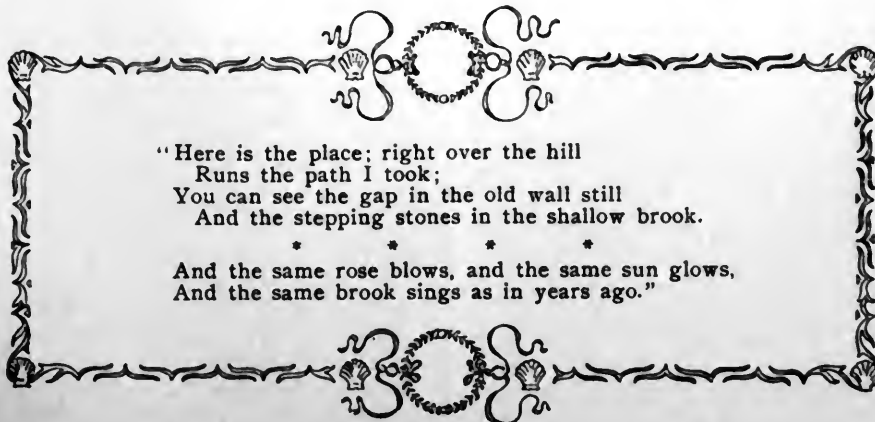

Contemporary Thought in America

"The Press of the Republic is the Moulder of
Public Opinion — the Leader and Educator"

GEORGIA

AMERICANISM CALLS FOR THE GOOD IN MAN—NOT THE BAD

EDITORIAL WRITER IN
THE ATLANTA CONSTITUTION

The barricades of tradition and the stone walls of revenge oppose no insuperable obstacle to the present-day iconoclast or the muck-raker. The dour-faced knights of either of these tribes will seek to lessen our faith in the Scriptures with as blithe a spirit as they tilt against the unhealthy methods of Packingtown or breathe to us softly of the iniquities of Standard Oil. Now they have even gone after George Washington, "the father of his country." There is produced what seems tolerably a tax dodger, that the cherry tree incident has been created out of the whole cloth, and that he freely used intoxicating liquors in influencing the votes of the bibulous in an election for burgess. Youth is cynical nowadays. Much reading and a spirit of inordinate curiosity and incredulity have bred skepticism which extends even to the lisper in the Sabbath school kindergarten. So that there is no spiritual *lese maieste* in stating that the men and women of to-day, not to speak of immature students, do not cherish the fond notion that Washington or any other of the pre-eminent figures of his day were more than human. We are quite sure they had faults. We are only glad that we are not sufficiently near them to bear witness to these faults. And we are also convinced that whatever their shortcomings, their virtues, especially in the case of Washington, overbalance far on the other side. That is one of the happiest and one of the most inevitable tricks of time. The dross in a great man's composition is burned away in the furnace of the years, and what stands forth for the inspection of posterity is pure gold. Of what use, then, is the activity of the jackanapes iconoclast? We willingly concede that the men who loom large in American history are linked to us by the flaws inseparable from flesh and blood. But we do not care to be reminded of those flaws. What we do need in an age given over to encroaching materialism is an abundant supply of high ideals. Woe be to the peering and ruthless ghouls of history who neglects more immediate and healthful demands for his activities to bring up smut out of the graves of illustrious men.

LOUISIANA

AN AMERICAN VIEW OF THE FUTURE OF SOUTH AFRICA

EDITORIAL WRITER IN
THE NEW ORLEANS PICAYUNE

Although defeated by the British in South Africa and compelled to accept the position of subjects of the British Empire, the Boers are in a fair way to accomplish by peaceable and even constitutional means what they failed to effect by force of arms. It is well known, despite the sympathy felt for the Boers during the war in the Transvaal several years ago, that the outbreak was the result of a well-planned scheme to establish an independent Boer confederation in South Africa, to include all that portion of the Dark Continent now known as British South Africa. Although the Orange Free State and the Transvaal Republic were independent as far as their internal administration was concerned, they still remained under British suzerainty. It is true that President Kruger and President Stein made light of the British pretensions, but the London government never failed to constantly assert them and always resented any attempt on the part of the Boer republics to hold relations with foreign countries except through the British authorities. Confident of the success of their schemes, the Boer leaders had everything ready for a successful rising in Cape Colony, and had the Boers succeeded in driving out the British and making secure the footing they obtained early in the war in Natal it is absolutely certain that they proposed to proclaim the independence of both Natal and Cape Colony and organize a greater Boer Republic to include the whole of South Africa. While the dream of independence has been dispelled, the Boers have not given up hope of eventually creating a South African dominion as an integral part of the British Empire, but still under the Boer control as far as administration is concerned. After several years' tenure of office, Dr. Jameson, the Premier of Cape Colony, has been forced to dissolve the Cape parliament owing to a legislative deadlock and appeal to the electors. With the Boer element firmly established in the Transvaal and in the Orange River colony as well as at the Cape, the task of re-establishing Boer rule in South Africa will be practically accomplished with much better chances of permanency than had Kruger succeeded in the recent war.

Contemporary Thought in America

INDIANA

AMERICA'S GREATEST POLITICAL IDOL AND HIS FAILURE

EDITORIAL WRITER IN
THE INDIANAPOLIS JOURNAL

The greatest popular idol in a political sense the country has ever known was Henry Clay. Only one other American statesman ever possessed the quality called personal magnetism to the same extent that he did, and no other ever had a more enthusiastic personal following. He was an aspirant for president from 1824 to 1848, but never reached the goal. He received thirty-seven electoral votes in 1824, forty-nine in 1832 and one hundred and five in 1844, but never enough to elect him. Clay was elected speaker of the house of representatives on the first day of his term in that body and was five times re-elected. He was twice elected United States senator, once unanimously by the Kentucky legislature, and held several other high offices. If there was ever a popular idol in the politics of this country, it was Henry Clay, but he could not be elected president.

Oklahoma will be the first American state to have at its beginning any large part of its voters of a race other than the Caucasian. The fact that Indians with full rights of citizenship are a large element in Oklahoma's population has given its organization as a state an unwonted interest. How would the Indians, there given for the first time a powerful voice in government, use their power? The record of Oklahoma's constitutional convention shows that the Indians there need no tutoring in politics. They proved that they knew what they wanted and how to get it. They showed political efficiency at every step along the road. The Indian delegates controlled the convention, shaped its work, and made the constitution, which it has submitted to the people. The Indian communities of Oklahoma seem to have been very much more alive than the white to the importance of the convention. All the newspaper correspondents agree that the Indian delegates averaged higher than the whites. Most of the white communities seem to have sent to the convention men of the mediocre grade that gets elected to state legislatures in "off" years. The Indian communities sent their best men, those most highly educated and experienced in affairs. The Indian delegates were strictly up-to-date in their political ideas. The constitution they framed calls for about all the "reform" ideas.

NEBRASKA

AMERICA SHOULD LEAD WORLD TO UNIVERSAL PEACE

EDITORIAL WRITER IN
THE LINCOLN COMMONER

The Hague Peace Conference has not accomplished as much as the friends of peace had hoped. The nations represented wanted peace but each one was anxious that it should be secured without any sacrifice on its own part. Some of the nations wanted to discontinue the use of navies in the collection of private debts, and this would have been a long step in advance, but other nations objected on the theory that they might want to collect the debts due some of their citizens. Various propositions were presented, and some of them received considerable support, but the final outcome is a disappointment. It is hard to secure peace by agreement when so many nations are to be consulted and so many conflicting interests are to be harmonized. The peace movement will make progress but that progress is not as rapid as it ought to be. But why should the United States wait for an agreement with other nations? It has it within its sphere to promote peace at once. It can announce its own policy and thus set an example to other nations. This example may not be followed at once but it will give the friends of peace in other nations something to work for and an argument to use. For instance, our nation could announce—and it should do so—its determination not to use the navy for the collection of private debts. This would be a beginning. Other nations would, one after another, follow its example, and a public opinion would be formed which would in time compel all nations to abstain from wars for the collection of private debts. There is another thing which our nation should do, and it should do it at once, namely, announce its willingness to enter into an agreement providing for the submission to an impartial tribunal, before the commencement of hostilities and the declaration of war, of all disputes which defy diplomatic settlement. If it will announce such a policy, it will find a number of other nations willing to make such an agreement, and these will set the pattern for the rest of the world. The failure of the Hague Conference to accomplish what it ought to have accomplished gives our nation an opportunity to lead the way and become the dominating factor in the promotion of peace.

Contemporary Thought in America

WASHINGTON

WORLD'S UPBUILDING IS IN NEED OF MORE MONEY

EDITORIAL WRITER IN
THE SEATTLE POST-INTELLIGENCER

M. Leroy-Beaulieu, in *Economiste Français*, explains at some length and with great lucidity the financial condition of the world, causing the present money stringency, which is felt elsewhere to precisely the same extent as it is in this country. The explanation of this distinguished writer on economic topics is precisely identical with that which has been given by well-informed writers in this country, with the addition that the French writer makes a fair attempt at giving the figures of the capital needed, and the available supply. He estimates, for example, that the savings in France—the new capital available for investment—reaches the amount of \$300,000,000 one year with another. In a conjectural way, he estimates that Germany, which is rapidly becoming rich, has an amount of savings annually for investment equal to those of France, and that the United States annually accumulates capital for investment equal to the combined savings of Germany and France. Other figures for all of the other countries of the world are estimated in a similar manner, with the conclusion that the total new capital of the world available for investment reaches an amount annually between \$2,200,000,000 and \$2,800,000,000, the latter being the extreme outside figure. As against this, during 1906 the demands for capital to be invested in new securities reached an aggregate of not less than \$3,250,000,000, and promises to be very much larger during 1907. This is the situation in a nutshell. The demands for capital exceeded the supply, and the point has been reached where the undertakings of the world must be limited until more capital becomes available. On the figures, the prospects seem good for high interest rates for at least two years, and possibly longer.

The savage, many generations ago, saw the wind blow, felt the force of the air. In course of time, after many experiments, the power of the air was harnessed to sails and the art of navigation was developed. Consider, then, the power of this earth current which makes the needle of the compass move. Suppose that an investigator along this line solves the secret of the power; that he or another man find the means of harnessing that power to human use. I believe this power can yet be controlled by man.—*New York World*.

MISSOURI

TREMENDOUS POWER HELD BY ONE AMERICAN FINANCIER

EDITORIAL WRITER IN
THE ST. LOUIS GLOBE-DEMOCRAT

The railroad and steamboat conquests of a single American capitalist to-day cover a large part of North America, and stretch themselves off to the hemisphere of Asia. The map which traces the course of his steamboat lines makes the Pacific look, not like a Japanese or an American sea, but like a Harriman lake. . . . Mr. Harriman may journey by steamship from New York to New Orleans, thence by rail to San Francisco, thence across the Pacific to China. And, returning by another route to the United States, he may go to Ogden, by any one of three rail lines, and thence to Kansas City or Omaha, without leaving the deck or platform of any carrier which he controls, and without duplicating any part of his journey. This looks like expansive language, but it does not soar nearly as much as it could, while still sticking to facts, for by Harriman's community-of-interest pacts he can ride across the continent to New York by either one of two rail routes without getting out of cars which obey his orders.

Texas is the biggest state in the Union. . . . The upper part of the Pan Handle of Texas is nearer to Chicago than it is to Galveston. Texas is as wide as the distance from Chicago to Boston, or from St. Louis to New York City. That is to say that from Texarkana to El Paso it is 1,100 miles. Texas has 3,000,000 folks, 10,000,000 cattle, 12,000,000 sheep and 3,000,000 horses. One horse, you see, for every man, woman and child in the state. People who have not seen the Southwest during the past five years cannot by any description realize its progress. What is known as "the Santa Fe country" can feed the world. Six years ago you could buy in Texas 1,000 sheep for \$1,000. Now 1,000 sheep will cost you \$8,000. The real crop in Texas, however, is not wool, but cotton. The cotton crop in Texas for the year 1906 was worth over \$200,000,000 in cold cash. They raise a bale of cotton on an acre, and a bale of cotton is worth \$60. Texas has the second most important shipping port in America, and if things continue going as they have for the past five years, in ten years more the shipments from Galveston will exceed in value the combined exports of Boston and New York.

Syllabus of the First Volume—Armvii

A CENTURY OF STEAM NAVIGATION —A series of sixteen of the first steamboats to sail inland waters from the port of New York—With double-page natural-color reproduction of the modern "Hendrick Hudson".....	423
ACROSS THE AMERICAN CONTINENT IN A CARAVAN—REMINISCENCES OF CAPTAIN JOSEPH ARAM —Recollections of a Journey from New York through the Western Wilderness and over the Rocky Mountains to the Pacific in 1846—Adventures with the Indians—First discovery of gold—First white child born in California—Early days on the Pacific Coast—Experiences of Captain Joseph Aram—Transcript from the Original now in Possession of His Children in California By Colonel James Tompkins Watson, of Clinton, New York	617
ADVENTURES IN THE AMERICAN NORTHWEST —Life story of a Pioneer Fur Trader and his experiences in the remote parts of the New World—How American business instinct led the way for civilization—Accurate transcript from an almost indecipherable manuscript recently discovered.....By Sir Peter Pond	357
ADVENTURES OF AN AMERICAN SEAMAN —Journal of Captain Samuel Hoyt, Born in 1744, and Followed the Roving Life of His Generation—On a Fighting Shlp off Havana, Cuba, in 1762—Experiences as a Prisoner on a Privateer—Wanderings as a Fugitive along the American Coast—Contributed.....By Jullus Walter Pease In His Ninety-Third Year	81
A MAN OF THE SOUTHWEST —Poem.....By John Vance Cheney, Chicago, Illinois	290
AMERICANA DUBIA—MOOTED QUESTIONS IN HISTORY —Open Discussions.....	765
AMERICAN CIVILIZATION IN THE GREATER ANTILLES By Honorable Beekman Winthrop, Governor of Porto Rico	232
AMERICAN FLAG—THE EMBLEM OF LIBERTY —Story of Its Evolution from the Discovery of the New World to the Present Age when the Sun Never Sets on the Stars and Stripes—Accompanied by a Silk Memorial Flag made by the Cheney Mills at South Manchester, Connecticut, and seven Silk Tissue reproductions in Original Colors.....Mrs. Henry Champion	9
AMERICAN PROGRESS IN THE GREAT SOUTHWEST ..By Hon. Thomas M. Campbell Governor of Texas	435
AMERICAN PROGRESS IN THE MIDDLE WEST —Voice of the people as expressed through the Governors of the American Commonwealth and "The Journal of American History".....By Honorable Albert B. Cummins, Governor of Iowa	433
AMERICAN PROGRESS ON THE PACIFIC COAST —Voice of the people as expressed through the Governors of the American Commonwealth to "The Journal of American History".....By Honorable Albert E. Mead Governor of Washington	226
AMERICAN SCIENTISTS BELIEVE JAPANESE ARE CAUCASIANS —Editorial writer in the "Indianapolis Star".....	576
AMERICANS—OUR FUTURE CIVILIZATION —Excerpt from Recent Public Utterance By Theodore Roosevelt, President of the United States, Cover	
AMERICA—THE RISE OF A STRONG PEOPLE —Nine hundredth anniversary of Thorfinn's Discovery of the Western Continent—Four hundredth anniversary of the Christening of the New World as America—Three hundredth anniversary of the Call of the Wilds to the Anglo-Saxons and the daring men who heard.....	201
AMERICA'S TRIBUTE TO FRANCE —A Centennial Ode to Comte de Rochambeau By John Gaylord Davenport, D.D.	712
A MOTHER'S LETTER TO HER SON IN 1789 —Transcribed from Original in Possession of.....Joseph Alsop, Descendant of Correspondent	96
AN AMERICAN'S EXPERIENCE IN THE BRITISH ARMY —Manuscript of Colonel Stephen Jarvis, Born in 1756 in Danbury, Connecticut, Revealing the life of the Loyalists who refused to renounce allegiance to the King and fought to save the Western Continent to the British Empire—Original Manuscript now in possession of.....Honorable Charles M. Jarvis, New Britain, Connecticut	441
AN AMERICAN'S EXPERIENCE IN THE BRITISH ARMY —Manuscript of Colonel Stephen Jarvis, born in 1756, revealing the life of the Loyalists who refused to renounce their allegiance to the king and fought to save the Western Continent to the British Empire—Relating the remarkable experiences as a recruit in the lines of the British army—Accurate transcript from the original manuscript which was lost for many years and has been recently recovered now in possession of Honorable Charles Maples Jarvis, Descendant of Colonel Jarvis and Member of many American learned and patriotic societies.....	727
AN AMERICAN'S OATH OF ABJURATION IN 1763 —Sworn to by Colonel Henry Ludington when appointed to the office of Sub-Sheriff—Accurate Transcript from originals in collection of Poughkeepsie, New York Literary Club.....	501

Contents with Engravings and Authors

ANCIENT MINIATURE OF EBENEZER JACKSON, SENIOR, A GENTLEMAN OF THE FIRST DAYS OF THE AMERICAN REPUBLIC—Original in the possession of Mr. Charles Eben Jackson.....	698
ANCIENT MINIATURE OF CHARLOTTE FENWICK—A BEAUTY OF THE REVOLUTIONARY PERIOD IN AMERICA—Original in the possession of Mr. Charles Eben Jackson.....	708
AN ANECDOTE OF COUNT ROCHAMBEAU IN AMERICA—"Come, Haste to the Wedding"—An Old Song—By the granddaughter of the heroine of this incident Susan E. M. Jocelyn	713
AN ATTEMPT TO SOLVE THE RIDDLE OF THE PLANETS—Editorial writer in the "Philadelphia Inquirer".....	576
ANCIENT AMERICAN LANDMARKS—Two illustrations of the first days of American industry.....	331
ANCIENT AMERICAN LANDMARKS—Two Photo-Engravings.....	162
ANCIENT ENGRAVINGS OF EARLY AMERICA—Prints from quaint pictures of the adventures of John Smith from 1597 to 1629 in green tint on imitation parchment	193
AN EARLY AMERICAN FINANCIER—General Robert Patterson of Philadelphia—Born in 1792—He was prominent in the development of the Sugar Industry of Louisiana and the Cotton Mills of the South—An organizer of Railroad Communication with Baltimore, a Financier of the Pennsylvania Railroad, and Steamship Transportation with the Southern ports and Europe—Portrait in possession of his granddaughter, Mrs. Lindsay Patterson of North Carolina.....	652
ANECDOTE OF AN AMERICAN REVOLUTIONISTBy Mrs. J. R. Cozart Lamar, Arkansas	72
AN INDIAN LEGEND—"The Flight of Red Bird".....By Joe Cone	333
ANNIVERSARIES OF THE AMERICANS—One Hundredth Anniversary of the Birth of Whittier the Poet—Two Hundredth Anniversary of the Birth of the Mother of Washington—One Hundredth Anniversary of Washington Irving's "Salmagundi" and William Cullen Bryant's "Embargo"—The Half Century Anniversary of the "Atlantic Monthly".....	613
AN ODE TO AMERICA—THE BUILDERS OF THE REPUBLIC—Poem by Judge Daniel J. Donahoe, Author of "A Message to Americans" in the preceding issue of "The Journal of American History".....	589
AN OLD ENGLISH PLAY ON AMERICA—The New World in 1607 was the Talk of the Taverns in the Old World and Playwrights Introduced it into their dramas—Extract from "Westward Hoe".....	219
AN OLD TAVERN SONG—Transcript from Fugitive Paper.....	79
ARMS CONFERRED FOR CHIVALRY—Accurate Translations of Latin Memorials Issued to John Smith for his heroism in the Wars of Hungary in 1603—Embellished with reproductions of the heraldic order.....	205
A TRIBUTE TO PEACE—Lunette on McKinley Memorial at Canton, Ohio By Charles H. Niehaus, Sculptor	599
AUTOBIOGRAPHY OF JOHN SMITH—His Own Story of His Birth, Apprenticeship and Youth—Embellished with family arms.....	204
A WEDDING SUIT IN 1756—Transcribed from Ancient Memorandum By Fannie M. Hackett, Biddeford, Maine	60
BAS-RELIEF OF CHARLES BROCKDEN BROWN, Father of Literary Trade in America.....By Dr. R. Tait McKenzie, Philadelphia, Pennsylvania	240
BEGINNINGS OF AMERICAN ARCHITECTURE—Six Photo-Engravings of Ancient Structures.....	167
BILL OF SALE OF A NORTHERN SLAVE IN 1721—Transcribed from Original By Eliza Comstock, Descendant of Slave-Holder	94
BOOK-LOVERS OF 1738—ONE OF THE FIRST LIBRARIES IN AMERICA—The Literary Inclinations of Early Americans—The Books They Read and Their Learned Discussions in Matters Intellectual and Moral—A Treatise on "Physick" was the Foundation of Literary Culture in the Discriminating Judgments of these First American Bibliophiles—with Portrait of the First Librarian of the Philogrammatican Library.....By Mrs. Martha Williams Hooker Great-Granddaughter of the Founder	177
BOOK PLATE OF REVEREND THOMAS RUGGLES PYNCHON, President of Trinity College, Hartford, Connecticut—Descendant of William Pynchon, 1630.....	516
BOUNDLESS RICHES OF THE AMERICAN INTERIOR....By Hon. George L. Sheldon Governor of Nebraska	437
CENTENARY OF GENERAL ROBERT E. LEE—His Last Portrait taken on His Old War Horse "Traveller"—Excerpt from Theodore Roosevelt's Writing by His Special Permission.....	Supplement 80

Transcripts from Ancient Documents

CENTENNIAL OF THE SAVINGS BANK—One hundred years ago the modern system was first outlined in the House of Commons—Duke of Wellington remarked that if men had money to spare it was time to reduce their pay—First savings banks in America and their marvelous effect on Industry and Thrift By Honorable Norman White	685
CIVILIZATION'S GREAT WORK IS IN ITS BEGINNING—Editorial writer in the "Toledo Blade".....	575
COMPULSORY MILITARY TRAINING IN AMERICA—Accurate transcript from original order issued in New England in 1765 and contributed.....By Benjamin C. Lum	230
CONTEMPORARY AMERICAN POETRY—An Ode to Niagara Falls—With Four Photo Art Engravings.....By Hon. Henry Taylor Blake, Now in His Seventy-Ninth Year	141
CONTEMPORARY THOUGHT IN AMERICA—"The Press of the Republic is the Moulder of Public Opinion—the Leader and Educator".....	
American Municipalities of the Future.....By T. E. Stafford in "Daily Oklahoman"	186
Progress is Adjusting the Race Problem.....By Frank Johnston In Jackson (Mississippi) "Evening News"	186
Marriage and Divorce are Subject to Evolution.....By J. W. Spear In Arizona "Republican"	187
Will American Republic Outgrow State Lines?.....By Gilbert D. Paine In Memphis (Tennessee) "News Scimitar"	187
American Constitution is in Advance of Times.....By Horatio W. Seymour In Chicago (Illinois) "Chronicle"	183
Shall America Limit Private Fortunes?.....By W. H. Merrell In Boston (Massachusetts) "Herald"	183
American Purpose is Common Good.....Editorial Writer in New York "Tribune"	189
America Must Save Lives of its Children Editorial Writer in Houston (Texas) "Chronicle"	189
America Extends Freedom to all Religions Editorial Writer in Montgomery (Alabama) "Advertiser"	190
Conquest for Pacific Must Not Come Editorial Writer in Philadelphia (Pennsylvania) "Inquirer"	190
CONTEMPORARY THOUGHT IN AMERICA—"The Press of the Republic is the Moulder of Public Opinion—the Leader and Educator".....	379
Must American Prosperity be Retarded.....By John P. Young In San Francisco (California) "Chronicle"	379
Are These America's Needs?—A Great Problem.....By George W. Norton In Portland (Maine) "Evening Express"	379
Omens of the Fiercest Conflict Known to History— In Louisville (Kentucky) "Herald"	350
North and South are United Forever In Richmond (Virginia) "Times-Dispatch"	350
Human Brotherhood—Hands Across the Sea In Charleston (South Carolina) "News and Courier"	381
Man's Ambition—Quest of the North Pole In Washington (District of Columbia) "Post"	381
CONTEMPORARY THOUGHT IN AMERICA—The Press of the Republic is the Moulder of Public Opinion—the Leader and Educator.....	575
CONTEMPORARY THOUGHT IN AMERICA—"The Press of the Republic is the Moulder of Public Opinion, the Leader and Educator".....	762
Americanism calls for the good in man, not the bad—Editorial writer in the "Atlanta Constitution".....	762
An American view of the future of South Africa—Editorial writer in the "New Orleans Picayune".....	762
America's greatest political idol and his failure—Editorial writer in the "Indianapolis Journal".....	763
America should lead world to universal peace—Editorial writer in the Lincoln "Commoner".....	763
World's upbuilding is in need of more money—Editorial writer in the "Seattle Post-Intelligencer".....	764
Tremendous power held by one American financier—Editorial writer in the "St. Louis Globe-Democrat".....	764
COUNTRY LIFE IN AMERICA—Series of blue-prints of summer landscape views.....	569

Contents with Engravings and Authors

COUNTRY LIFE IN AMERICA—Six Nature Reproductions.....	129
Path Through the Wood—Drawing by Daniel F. Wentworth.....	129
Moonlight—Drawing by Daniel F. Wentworth.....	130
The Road Home—Sun Gravure by George C. Atwell.....	131
The Old Mill—Sun Gravure by George C. Atwell.....	132
The Meadows—Drawing by Daniel F. Wentworth.....	133
The Brook—Sun Gravure by George C. Atwell.....	134
DAVID NOBLE—PATRIOT OF PITTSFIELD—He gave his wealth and then his life to the cause of American Independence.....	By Mrs. Sara B. Francis Philadelphia, Pennsylvania 376
DAWN OF THE NEW WORLD—First Permanent English Settlement in America—Foundation of the people who in three hundred years have stretched over dominions and millions across the continent and whose influence permeates the earth—The Nations of the World extend tribute on this ter-centennial—With ten reproductions of rare engravings and paintings.....	Honorable H. St. George Tucker President of the Jamestown Exposition 209
ESTATE OF A PROSPEROUS AMERICAN IN 1684—"Inventory of Lewis Jones, lately deceased, of goods and chattel taken by us whose names are now written this twentieth day of April, 1684"—Transcript from original.....	By Walter E. Jones of Waitsfield, Vermont, a descendant of the legator 366
ESTATE OF A "WELL-TO-DO" AMERICAN IN 1689—Transcribed	By M. Augusta Holman, Leominster, Massachusetts 80
ESTATE OF "A WELL-TO-DO" VIRGINIAN IN 1674—Transcribed from the Original by Dr. Joseph Lyon Miller, grandson of the Seventh Generation, Thomas, West Virginia	573
EX LIBRIS—American adaptation of the old art of Book Heraldry that originated within half a century of the invention of printing—Reproductions of book plates of William Penn of Pennsylvania and Paul Revere of Massachusetts.....	304
EXPERIENCES IN EARLY WARS IN AMERICA—Life Story of an Ambitious American Youth who at Sixteen Years of Age was Fired with the Spirit of Patriotism and against the Will of his Parents Marched to the Battle Line in Defense of His Country—Original Journal of Peter Pond, Born in 1740—Transcribed	By Mrs. Nathan Gillette Pond, an Eminent Genealogist 89
EXPERIENCES OF AN AMERICAN EDUCATOR IN FIRST YEARS OF THE REPUBLIC—Manuscript of James Morris, born in 1752, in which he tells of being charged with violation of Christian peace and placed on trial for conducting a private school and instructing young women in higher education—Personal narrative of an early lecturer on public morals—Original manuscript in possession of Mrs. Washington Choate, great-granddaughter of James Morris—Sketches by Florence E. D. Muzzy.....	717
FACSIMILE OF LETTER WRITTEN BY ROBERT FULTON in which he confided his doubts in the problem of steam navigation—Original in the archives of Lenox Library, in New York.....	433
FAIR, COOLING SPRAY, O LOVELY SEA!.....	By Dr. Frederick H. Williams 568
FATHER OF BIBLICAL CULTURE IN AMERICA—Reminiscences of the First American Biblicalist who found Religious Thought under Dominion of Iron-Bound Metaphysics and Disenthralled it from its Slavery—First Contributions to Biblical Literature and First School for Education to Ministry—Life of Moses Stuart—Born 1780.....	By John Gaylord Davenport, D.D. 545
FIRST AMERICAN'S GREETING TO THE WHITE MAN—Sculpture	By Herman Atkins McNeil, National Society of Sculpture 144
FIRST CHAMPION OF UNIVERSAL PEACE—Memories and Anecdotes of Elihu Burritt, an American Farmer-lad who Rose from a Blacksmith Forge and Through Self-instruction Acquired the Tongues of Fifty Nations—He Appealed to Christendom to Cease Warfare and Became Honored by the Master Minds of the Old World—With Prophecy of Victor Hugo and Last Portrait of Elihu Burritt	By Hon. David Nelson Camp, M.A., Department of Education at Washington in 1867 151
FIRST COLLECTION OF STEAMBOAT PAINTINGS IN THE WORLD—Blue-print reproductions of James Bard's Famous Canvasses of Early American Marine Architecture	413

Transcripts from Ancient Documents

- FIRST FORTUNES IN AMERICAN REPUBLIC**—Letters of a Banker who helped to Establish the Credit of American Business Houses in the European Market—Great Commercial Ventures in the Tropics—Trading Voyages to China—Opening Traffic on the St. Lawrence River and Lake Ontario—Founding a Fortune in America one hundred years ago—Correspondence of David Parish and Joseph Rosseel.....By Frank R. Rosseel, Buffalo, New York
Grandson of Joseph Rosseel, the Financial Agent of the Parish Estate 745
- FIRST NEWS OF AN AMERICAN VICTORY**—This is an account of the joy that reigned throughout America on the news of victory, told by an eye-witness, Stanton Sholes, who was born March 14, 1772, married Abigail Avery on March 14, 1793, and died February 7, 1865, at Columbus, Ohio, in his ninety-third year—Accurate transcript from Original Manuscript—Contributed by
Sarah Elizabeth Sholes Nighman, great-granddaughter of the narrator
Bayonne, New Jersey 563
- FIRST PAPER MONEY IN AMERICA IN 1690**—Actual facsimile of the First Paper Money in America, which eventually led to the American Banking System—First authorized to meet the necessities of the Colonial Treasuries to wage war, and soon became generally established in relieving commercial and financial embarrassment.....By Henry Russell Drowne,
Of the American Numismatic and Archaeological Society 693
- FIRST PATENT IN AMERICA**—Granted in 1646 to the inventor of "an engine of mills to go by water" and recorded as "Jenkes Mopolye"....By Emeline Jenks Crampton
Lineal Descendant of the Patentee 334
- FIRST PHYSICIANS IN AMERICA**—Customs and practices of early Doctors as revealed in correspondence of John Winthrop, born in 1606—Dutch, Quakers and Puritans consulted him regarding their physical ills—The New World is full of his praises—Beginning of American medicine—With eleven transcripts of ancient letters, and reproduction of oil portrait of John Winthrop
By Walter R. Steiner, M.A., M.D. 241
- FIRST PUBLIC SCHOOLS IN NEW YORK**—Rare old print made in 1840—The Lancaster Monitorial School, an educational idea imported from England..... 718
- FIRST SILHOUETTISTS IN AMERICA**—Earliest extant type of Pictoriology—Brown's notable collection of portraits of distinguished Americans—With reproductions from Original Silhouettes of Daniel Webster of Massachusetts, Andrew Jackson of South Carolina, John Randolph of Virginia, Bishop William White of Pennsylvania.....By Howard Marshall 367
- FOUR HUNDRED YEARS OF THE PANAMA CANAL**—First White Man to Cross the Isthmus from the Atlantic to the Pacific—Futile attempts to find a Natural Waterway Connecting the two Great Oceans—First Plans ever made to sever the Americas with an artificial strait by Cortez in 1529—Investigations by Dr. Willis Fletcher Johnson, of the "New York Tribune"—Resume from his researches recently presented after more than twenty-five years' study of South American affairs and Isthmian Canal Transit in his book "Four Hundred Years of Panama," published by Henry Holt and Company of New York..... 633
- GREAT HEART OF THE AMERICAN DOMINION**—Narrative of journey in the wilderness of the Mississippi Valley in 1789-1790—The experiences in the West Region that is gaining control of the American nation and now contains twenty-two of the forty-five United States—Travel in early days of American Republic—With reproductions and prints.....By Major Samuel S. Forman 337
- HERALDIC ILLUMINATION**—Coat-of-arms of Mary Ball, the Mother of the First President of the First Republic in the World—Emblazoned in gold, silver and colors by.....Charles L. N. Camp
- HERALDIC ILLUMINATION**—Coat-of-arms in use by the Hooker Family in America as descendants of Thomas Hooker, emigrant in 1633, and author of the First Written Constitution in the World, creating a government—Emblazoned in six colors by.....Charles L. N. Camp
- HERALDIC ILLUMINATION**—Coat-of-arms of Captain John Smith, of the first permanent English settlement in America—The three Turks' heads were conferred upon him by Sigismundus Bathor, Duke of Transylvania, for bravery in the Wars of Hungary—Emblazoned in six colors.....By Charles L. N. Camp
- HERALDIC ILLUMINATION**—Coat-of-arms of the Fulton Family in America—Illuminated especially as a Memorial to Robert Fulton, the promoter of steam navigation, on this Centenary of his achievement—Emblazoned in six colors
By Charles L. N. Camp

Contents with Engravings and Authors

HERE LET ME DWELL—A Poem.....	By Frederic E. Snow, B.D.	145
HERITAGE OF YEARS—Poem.....	By Howard Arnold Walter	508
HIEROGLYPHIC NARRATIVE OF THE CAREER OF GENERAL ROBERT PATTERSON—Reproduction from original made by his son, Colonel William Houston Patterson, in imitation of the character writing of the American aborigines.....		660
HOME LIFE IN OLD AMERICA—Eight reproductions of Ancient Estates in phototone.....		325
IN HONOR OF A VALIANT ADVENTURER—Loving lines inscribed to gallant John Smith by Compeers—Ter-centenary statue to be unveiled in September on the scene of the American explorations.....	By William Couper, New York City	225
IMMUTABILITY—An Illustrated Poem.....	By Frank Burnham Bagley	175
IN THE FIRST HOMES OF AMERICA—With four exhibitions of antique furniture	By Clara Emerson Bickford	328
IN THE FIRST HOMES IN AMERICA—With reproductions of antique furniture	By Clara Emerson Bickford	494
I WHO HAVE DRUNK THE WATER BITTER SWEET—A Sonnet..	By Horace Holley	166
LAST LEAF—EDITORIAL COMMENT		
LETTERS OF A SERGEANT IN WAR OF 1812—Romance of John Burt, First Battalion Artillery, and Persis Meacham—With Transcripts from Correspondence and two Ancient Silhouettes.....	By William Burt Harlow, Ph.D., Now in the Bermudas	147
LETTERS OF EARLY AMERICAN WARRIORS—Correspondence of the first citizens of the Nation, revealing their Personalities and Private Lives—A Romance of the North and South more than a century ago—Intimate friendships of distinguished Americans—Social relations of the families of Officers in the early wars—Cut of Powder Horn presented to General Jackson in 1782 for his Bravery in the American Revolution—From original letters now in possession of Charles Eben Jackson, a descendant of General Michael Jackson.....	By Mabel Cassine Holman	697
LIFE ON AN AMERICAN TRADING VESSEL—Adventures on the High Seas in the First Days of American Commerce when Privateering was a Prosperous Occupation and Daring Men Chose the Hazards of Seamanship—Journal of Samuel Hoyt, an Early American Sea Captain, Born in 1744—Transcribed by Julius Walter Pease		485
LIFE ON GREAT AMERICAN PRAIRIES A GENERATION AGO—Two prints from "In the Valley of the Mississippi!".....	By Wm. H. Milburn	336
LIFE STORIES OF GALLANT AMERICANS—John Thomas—Colonel of Spartanburg and Jane Thomas' Famous Ride.....	By Mrs. Robert J. Herndon	373
LIFE STORIES OF GALLANT AMERICANS.....		73
John Moor—The Knight of Derryfield—Contributed. By Mrs. Lina Moore McKenney	Madison, Maine	73
James Caldwell—Hero of Elizabethtown—Contributed. By Mrs. Hiram Price Dillon	Topeka, Kansas	76
LIFE STORIES OF GALLANT AMERICANS—The Lanes—Cavalliers of the South—In the Wars of Early America... By Mrs. Louisa Kendall Rogers, Barnesville, Georgia		565
MAP OF NEW YORK A CENTURY AGO when first successful steamboat in the world, the "Clermont," sailed up the Hudson river—The city then had about 83,000 inhabitants and was concentrated below Spruce Street—It was then planned to preserve a system of boulevards along the water-front and construct harbors rather than piers for shipping purposes—Modern commerce made this aestheticism impractical and the rise of steam navigation sacrificed municipal art to the greater demand of public utility.....		416
MARRIAGE CONTRACT IN AMERICA IN 1675—Transcribed from original	By Mary R. Woodruff	320
MEMOIRS OF A SOUTHERN CONGRESSMAN—Ranging the Borderlands with Daniel Boone—Encounters with the Cherokees in Command of the Light Dragoons—Electioneering in American Politics a Hundred Years Ago—On the Floor of Congress during the Monroe Administration—Old Manuscript left. By Hon. Felix Walker	Born in Virginia in 1753	49
MODERN AMERICAN SCULPTURE—The "Aztecs".....	By Louis A. Gudebrod Member of the National Sculpture Society	332
MUSIC IN AMERICA—The Struggles of the First Composers against Public Condemnation.....	By Clara Emerson	173

Transcripts from Ancient Documents

NATURE'S GRANDEUR IN AMERICA—The Monarch Niagara—Four Reproductions from Nature Illustrations.....	741
OATH OF ALLEGIANCE TO KING GEORGE III—Sworn to by Colonel Henry Ludington on March 12, 1763, in Dutchess County in the Province of New York, before being allowed to take office as Sub-Sheriff—Accurate Transcript.....	501
OBSERVATIONS OF AN EARLY AMERICAN CAPITALIST—"HE WAS BORN A KING"—An Early Journey in the Mississippi Valley—Accurate Transcript from Journal of General Robert Patterson, born in 1792—An intimate friend of all the Presidents from Jefferson to Garfield, and one of the greatest merchant-magnates of his generation—Eminent Americans and Europeans gathered at his mansion in Philadelphia—Original diary in possession of his granddaughter, Mrs. Lindsay Patterson, of Winston-Salem, North Carolina.....	653
ODE TO AMERICA.....	297
By Donald Lines Jacobus	
OLD PRINT OF AN INFANT SCHOOL IN NEW YORK IN 1825.....	718
ONE HUNDREDTH ANNIVERSARY OF THE FOUNDING OF THE "SALMAGUNDI" IN 1807—Reproduction from an Old Engraving of Washington Irving, after a painting by Alonzo Chappel—Likeness from a daguerreotype in possession of the family of the distinguished litterateur.....	615
ONE OF THE FIRST INSTANCES OF BOYCOTT IN AMERICA—Transcript from Original Document.....	88
By Ella S. Duncan, Keokuk, Iowa	
ON THE HILLTOPS.....	568
By Josephine Canning	
OPPORTUNITIES IN THE NORTHERN BORDERLAND.....	235
By Honorable E. Y. Sarles Governor of North Dakota	
PAINTING IN AMERICA—The First Artists and Their Experiences on the Western Continent—With three Reproductions from Rare Paintings.....	169
By Stuart Copley	
PAINTING OF ROBERT FULTON—By his intimate friend and fellow-artist, Benjamin West—Original now in the possession of Fulton's grandson, Robert Fulton Ludlow, of Claverack, New York—Centenary reproduction in sepia-tone in "The Journal of American History" by permission of Fulton family.....	392
PERSONAL LETTERS OF PIONEER AMERICANS—Glimpses into Time-stained and almost indecipherable Correspondence Revealing the Strong Character, Conscientious Lives, Domestic Customs, Business Integrity and Courageous Hardihood of First Citizens of the Republic—Contributed by.....	559
Miss C. C. Thacher	
PERSONAL LETTERS OF PIONEER AMERICANS—Glimpses into Time-stained and almost indecipherable Correspondence Revealing the Strong Character, Conscientious Lives, Business Integrity and Hardihood of the First Citizens of the Republic	61
Letter Sent by Post-boy from William Prentiss, during the Plague in Philadelphia, to Dr. Jeremiah Barker, Fallmouth, Casco Bay, Massachusetts, in 1793—Transcribed from Original.....	61
By Abbie F. Carpenter, Portland, Maine	
Letter Written to Reverend Chandler Robbins of Plymouth, Massachusetts, by Reverend Little in Birmingham, England, Discussing the Moral Problems in 1797—Transcribed from Original.....	62
By Mrs. Lydia J. Knowles, Bangor, Maine	
Letter Sent by George Washington, in 1797, to Honorable Oliver Ellsworth, a Frammer of the Constitution, Minister to France, and Chief Justice of the United States—Transcribed from Original.....	63
By Adaline B. Ellsworth Roberts Ollana, Illinois	
PHINEAS SLAYTON—The Venerable Volunteer—He Fought in the American Revolution and had to be "Coaxed to go home" in the War of 1812—Anecdote contributed	
By Carrie J. Doane of Arlington, Iowa	378
PHILOSOPHY OF DEATH IN EARLY AMERICA—Manuscript by the Reverend Joseph Webb, Born in 1666, and an Intellectual and Moral Leader of His Times—Occasioned by the Demise of Major Nathan Gold, in 1693, who was Foremost in Political, Military and Ecclesiastical Affairs—Original Sermon Transcribed	
By Mrs. Elizabeth Hubbell Schenck, Washington, District of Columbia	65
PHOTOGRAPHIC REPRODUCTION OF THE TITLE-PAGE OF FAMOUS OLD "BISHOP'S BIBLE"—Published in 1584, and still in possession of the Seymour Family in America—A survival of the earliest book-making.....	616
PILOT OF FIRST WHITE MEN TO CROSS THE AMERICAN CONTINENT—Identification of the Indian Girl who Led the Lewis and Clark Expedition Over the Rocky Mountains in their Unparalleled Journey into the Mysteries of the Western World—Recognition of Sacajawea as the Woman who Guided the Explorers to the New Golden Empire—With nine reproductions from sculpture and rare prints	
By Grace Raymond Hebard, Ph.D., of the University of Wyoming	467

Contents with Engravings and Authors

PIONEER LIFE ON AMERICAN FRONTIER —Experiences of a Federal Justice on the Trail of the Prairie Schooners—Carrying the Law into the Western Wilderness—Treaties with the Indians and the Establishment of Courts in a New Land of Gold and silver—The Birth of the Rich West—Several illustrations bearing the lines "Old Prints in Possession of Judge Munson" should be credited to Hon. William Henry Milburn's work "In the Valley of the Mississippi." Judge Munson wishes it fully understood that these illustrations are from Mr. Milburn's original work, a copy of which was presented to a member of his family by the author. The work is published by the N. D. Thompson Publishing Company of New York and St. Louis and should be read by all who are interested in American pioneer life. Judge Lyman E. Munson United States District Court of Montana in 1865	97
PLEA FOR PROTECTION FROM THE ENEMY —Accurate Transcript from Original letter written by Colonel Henry Ludington after he had espoused the cause of American Independence and his oaths to the King.....	503
PLEDGE OF THE PATRIOTS TO FREE AMERICA —Signed by Americans in 1776—Transcript from Original in Possession of the Misses Patterson of Patterson, New York—Colonel Henry Ludington Renounced his former oaths and signed this document at the beginning of the American Revolution.....	503
PRIVATE LETTER WRITTEN BY GEORGE WASHINGTON , Father of the American Republic, to an intimate friend in which he warns against impending dangers...Cover	
PROGENY OF SAXON KINGS IN AMERICA —Unbroken Line of Descent from Egbert, First King of all England—800-838, to William Tracy of Hayles Abbey who came to America in 1620—Royal Lineage Sustained through Thomas Tracy of Connecticut, 1636—Illustrated with eighteen Rare Reproductions from Ancient Documents Dwight Tracy, M.D., D.D.S.	517
PROSPERITY —Pediment for Kentucky State Capitol..By Charles H. Niehaus, Sculptor	599
PUBLIC CARE OF THE POOR IN EARLY AMERICA —Accurate transcript from records of Watertown, Massachusetts.....By M. Augusta Holman Leominster, Massachusetts	233
QUAINT WILL OF A NEGRO SLAVE IN 1773 —Transcribed from Original By Eliza Comstock	95
REMINISCENCES OF MOSES STUART —Born in 1780—By his daughter Mrs. Sarah Robbins, Newton Highlands, Massachusetts	557
RESOURCES OF THE GREAT NORTHWESTBy Honorable Joseph K. Toole Governor of Montana	234
ROBERT FULTON AS AN ARTIST —Reproduction in sepia-tone of his painting of Joel Barlow, the poet and diplomat, who was Fulton's most intimate friend when the inventor proposed to Napoleon the power of steam as a destroyer of the navies of the world but met with rebuff—Original is now in possession of the Barlow family in New York and a replica is owned by Fulton's grandson, Robert Fulton Ludlow of Claverack, New York.....	401
SCULPTURE IN AMERICA —A Symposium of the Finest Pieces of Sculpture erected during the year of 1907.....	597
SCULPTURE IN AMERICA —The First Sculptors and Their Hardships in the New World—With two Reproductions from Early Sculpture.....By Bickford Cooper	163
SECRET SERVICE OF AMERICAN REVOLUTION —Incidents in which Imminent Defeat was turned to Glorious Victory—Repressing the Ravagers of Property on the Outskirts of the Army—Anecdotes of Colonel Henry Ludington, Born 1739, and the Heroism of his Daughters who Saved him from Capture and Execution—Related by.....Louis S. Patrick	497
SONNET —"Oh Ye That Keep the Rule of Modern Town".....By Horace Holley	365
SONNETBy Horace Holley	464
STRUGGLES OF THE FIRST CITIZENS IN AMERICA —True Record from the time of departure from England in 1606, to the arrival in Virginia in 1607 and the hazardous beginnings of a World Power—From the Journal of William Simons, "doctor of divinitie".....	206
TAVERN AND POST ROAD —With three illustrations.....By Norman Talcott	321

Transcripts from Ancient Documents

THE ACADEMY OF AMERICAN IMMORTALS—The Hall of Fame.....	135
Bronze Medallion of George Washington, First President of United States.....	136
Bronze Medallion of Abraham Lincoln—First Great American Liberator.....	137
Bronze Medallion of Daniel Webster, First Great American Statesman.....	138
Bronze Medallion of Benjamin Franklin, First Great American Diplomat.....	139
THE ACADEMY OF AMERICAN IMMORTALS—The Hall of Fame.....	301
Bronze Medallion of Nathaniel Hawthorne—American Novelist.....	302
Bronze Medallion of Washington Irving—An American Litterateur.....	303
Bronze Medallion of Ralph Waldo Emerson—American Philosopher.....	302
Bronze Medallion of Samuel Finley Breese Morse—American Inventor.....	302
THE AMERICAN PEOPLE MUST LEAD VAN OF PROGRESS—Editorial writer in the "Denver Republican".....	575
THE AMERICAN SPIRIT IN THE MISSISSIPPI VALLEY.....	439
By Hon. Joseph W. Folk Governor of Missouri	
THE ANNIVERSARY OF AMERICAN COMMERCE—Ter-Centenary of the building of the "Virginia," the First Ship Constructed on the Western Continent—Centen- nial of the "Clermont," First Steamboat in the World—The Rise of the American Merchant Marine and the Development of a Century of Navigation since Robert Fulton—Illustrated with many rare blue-prints and engravings	
By C. Seymour Bullock	
	395
THE CENTENARY OF AN AMERICAN POET—Henry Wadsworth Longfellow—Born at Portland, Maine, February 27, 1807—Died at Cambridge, Massachusetts, March 24, 1882—Four Sonnets inscribed to His Memory and Centennial Bas Relief	
By Louis A. Gudebrod, National Society of Sculpture	
	64
THE DEVELOPMENT OF AMERICAN FINANCE—Its moral effect on American citi- zenship—Liberty and the mighty economic problem—The democracy of negotiable securities—The Ten Commandments in business—By the Editor of the "Wall Street Journal".....	687
Serenio D. Pratt	
THE FATHER OF THE AMERICAN NAVY—JOHN BARRY—First commander of the first vessel to fight under the American Flag—The "Lexington," named after the first battle in the American Revolution, captured the first British ship in the strug- gle for Independence—The story of Commodore John Barry, Born in 1745	
By Richard M. Reilly, Member of the Pennsylvania Bar	
	669
THE FIRST AMERICAN NOVELIST—Experiences of the first writer in the New World to make literature his sole pursuit and to earn a livelihood by Pen—The first American Fiction to create a Literary market was "Wieland," the tale of mys- tery—Career of Charles Brockden Brown—By permission of the author from his Literary History of Philadelphia.....	236
By Ellis Paxson Oberholtzer, Ph.D., University of Pennsylvania	
THE FIRST AMERICAN SOLDIERS—Call "To Arms" began with Arrival of First White Men in the New World—Footmen with Musket and Pike—Horsemen with Pistol and Carbine—Military Force Blazed Path for Civilization—Heroic "Trained Bands" and the Organization of the Continental Army... 	120
By Hon. Spencer P. Mead Of the New York Bar	
THE FIRST ROMANCE IN AMERICA—The story of the heroism and fortitude of Poca- hontas—Her marriage to John Rolfe, the first union of the Western Continent and the Eastern Hemisphere—With six reproductions from rare engravings and paint- ings.....	221
THE FIRST STEAMSHIPS TO CROSS THE OCEAN—Recollections of men who partici- pated in first futile attempts to interest capital in the Possibilities of Communica- tion between the Continents by Steam—Opening the Gateways of the World—His- toric Voyages—Beginning of Commerce—With transcript of log of the Savannah and twenty-nine rare prints of the development of steam navigation	
By C. Seymour Bullock	
	261
THE GREETING TO THE NATIONS—AMERICA'S BIRTHDAY—1607—1907—Words of Wisdom spoken by the Man who has been chosen by the People of our United States of America as their Leader—Excerpt from the Speech of the President at the opening of the Jamestown Exposition—Autograph copy kindly presented to "The Journal of American History" by.....	581
Theodore Roosevelt	
THE HISTORIAN—Poem.....	567
By Herbert Hughes	
THE HOME OF MY CHILDHOOD—Illustrated poem.....	289
By Anna J. Granniss	
THE LAST LEAF—Editorial Comment.....	382, 578, 766

Transcripts from Ancient Documents

- THE MESSAGE TO THE AMERICANS—Poem.....By Judge Daniel J. Donahoe 393
- THE "MIRACLE" OF THE FIRST STEAMBOAT—Tragedy of an American Genius who was Publicly Ridiculed as a "Fanatic" for Proposing the Propulsion of Vessels by Steam against Wind and Tide—The Idea was Pronounced "Impracticable" and to Risk Life in its Undertaking "Foolhardy"—Eleven Reproductions from Rare Prints.....By Seymour Bullock 33
- THE MILLENIUM OF AMERICAN CITIZENSHIP.....By Hon. Curtis Guild, Jr. Governor of Massachusetts 436
- THE NOBLER RACE—Poem.....By Frank P. Foster, Jr. 484
- "THE PASSING OF THE DAY OF GREED"—Symbolic Photograph by John Gudebrod, of New York—Taken in the Early Evening at Castle Craig on the Peaks of Meriden.....
- THE RISE OF A NEW SURGICAL SCIENCE—Evolution of a Personal Adornment into the Self-Protection of the Human Race—Uplift of a Menial Trade to a Great American Profession which now bears the "Hall Mark" of Culture and has become a part of the American Educational System—The birth of Dental surgery
By Dr. James McManus,
Author of a Treatise on "History of Anaesthesia,"
and a Dean of American Dentistry 675
- THE RISE OF THE BOUNTEOUS SOUTH—Excerpt from speech by
Honorable Claude A. Swanson, Governor of Virginia 438
- THE STRUGGLE FOR THE CONTROL OF AMERICA—THE GREAT STORY OF THE CARIBBEAN SEA—Ambition of the European Powers to add the Western Continent to their Empires—America's fate in the balance during the Great Battles on the Spanish Main—Daring adventures of the Great Admirals of the Caribbean Sea—Researches by Franklin Russell Hart, Member of many learned societies and Fellow of the Royal Geographical Society of Great Britain—Copyright assigned to the author..... 640
- TO THE AMERICAN PEOPLE—THE VOICE OF THE STATES—Expressed in Personal Messages from the Governors to "The Journal of American History"
- "America's Greatest Need is Civic Virtue".....Honorable George E. Chamberlain Governor of Oregon 17
- "Higher Standards of Public Service".....Hon. George R. Carter, Governor of Hawaii 18
- "Future Mastery of the Pacific Ocean".....Hon. George C. Pardee Governor of California 21
- "An Inspiration for Worthy Work".....Hon. Fred M. Warner, Governor of Michigan 23
- "Strong, New Blood Elevates Citizenship".....Hon. Bryant B. Brooks Governor of Wyoming 24
- "The Native Honesty of the Nation".....Hon. John C. Cutler, Governor of Utah 25
- "American in Spirit and in Aspiration".....Hon. Andrew L. Harris, Governor of Ohio 26
- "Wholesome Immigration is a Builder".....Hon. J. O. Davidson, Governor of Wisconsin 27
- "Commercialism Must Not Dominate America".....Hon. Joseph M. Terrell Governor of Georgia 29
- "The Spirit of Patriotism Still Lives".....Hon. Wm. T. Cobb, Governor of Maine 31
- TO THE MEMORY OF A GERMAN-AMERICAN SOLDIER—General Franz Sigel—For Riverside Drive, New York City.....By Karl Bitter, Sculptor 601
- TO THE MEMORY OF A GREAT AMERICAN MATERIALIST—Colonel John A. Roebling, First Engineer of Brooklyn Bridge—Builder of the Great Span across Niagara Falls—For erection at Trenton, New Jersey.....By William Couper, Sculptor 600
- TO THE MEMORY OF AMERICAN SACRIFICE—Erected at the old Andersonville Prison Grounds, in Georgia.....By Bela Lyon Pratt, Sculptor 603
- TO THE MEMORY OF AN AMERICAN WARRIOR—General George Brinton McClellan Erected at Washington, District of Columbia..By Frederick MacMonnies, Sculptor 606
- TO THE MEMORY OF A ROUGH RIDER WITH ROOSEVELT AT SANTIAGO—Captain "Buckey" O'Neill, killed in battle—Erected at Prescott, Arizona
By Solon H. Borglum, Sculptor 611
- TO THE MEMORY OF A SOUTHERN WARRIOR—General John B. Gordon—Erected at State Capitol Grounds at Atlanta, Georgia.....By Solon H. Borglum, Sculptor 609
- TO THE MEMORY OF THE AMERICAN SAILOR—For the monument to Soldiers and Sailors at Webster, Massachusetts.....By Finn H. Frolich, Sculptor 605
- TO THE MEMORY OF THE AMERICAN SOLDIER—For the monument to Soldiers and Sailors at Webster, Massachusetts.....By Finn H. Frolich, Sculptor 604

Contents with Engravings and Authors

TO THE MEMORY OF THE DISPATCH RIDER OF THE WAR FOR AMERICAN INDEPENDENCE—Erected at Orange, New Jersey By Frank Edwin Elwell, Sculptor	607
TO THE MEMORY OF THE FIRST AMERICANS—Statue of the Indian Chief, Mahaska Now being exhibited in the Salon at Paris—To be erected at Oskaloosa, Iowa By S. E. Fry, Sculptor	612
TO THE MEMORY OF THE FIRST FALLEN IN THE SPANISH-AMERICAN WAR— Ensign Worth Bagley, U. S. N., the only Naval Officer killed during that war— Erected in Capitol Square, Raleigh, North Carolina.....By F. H. Packer, Sculptor	608
TO THE MEMORY OF THE HEART OF THE SOUTH—An Allegorical Figure bearing a Palm of Peace and Branch of Laurel covering the Sword, an Emblem of Glory For erection at Houston, Texas.....By Louis Amatels, Sculptor	597
TO THE MEMORY OF THE MARTYRED PRESIDENT—WILLIAM McKINLEY— Erected in bronze in front of the National Memorial at Canton, Ohio By Charles H. Niehaus, Sculptor	610
TO THE MEMORY OF THE TEXAS RANGERS—Erected at the State House in Austin, Texas.....By Pompeo Coppini, Sculptor	602
TRADE OF A MULATTO BOY IN 1765—Accurate Transcript from Original Document in Possession of.....Mary R. Woodruff, Orange, Connecticut	440
TRAVEL IN AMERICA—Excerpt by Roland D. Grant, an American traveler—With four nature illustrations in photo-tone.....	292
TRIALS IN EARLY JUSTICE COURTS IN AMERICA—Court record of Justice Jabez Brainerd, 1773-1775—Serious crimes included "Profane cursing and swearing"— The "Gilty" were sentenced to stock and whipping-post—Debtors frequently bound over to their creditors in servitude—Beginning of American law By Reverend Bert Francis Case	284
TWO HUNDREDTH ANNIVERSARY OF THE BIRTH OF THE MOTHER OF WASH- INGTON—Ancient Engraving Dedicated to her Memory—The Original is in the Collection of John M. Crampton, and is known as "Washington's Last Interview with his Mother".....	
UNTOLD RICHES OF THE ROCKY MOUNTAINS.....By Honorable Frank R. Gooding Governor of Idaho	231
UTILIZATION OF INVENTION OF GENIUS OF MAN—Editorial writer in the "Pater- son Morning Call".....	577
VOYAGES OF AN OLD SEA CAPTAIN—Adventures in South America and in the ports of the Old World during the first years of the American Republic—An American citizen impressed into the British service—His daring escape after years of cap- tivity and conflict—Autobiography.....By Captain Jeremiah Holmes	305
VOTE TO PROSECUTE NON-CHURCH GOERS IN 1664—.....By S. L. Griffith of Danby, Vermont	355
"WE WANT PATRIOTS IN EVERY-DAY LIFE"—Excerpt from speech made by Honorable Charles E. Hughes, Governor of New York	434
WHEN DAYLIGHT DIES—An Evening Pastoral—With four nature illustrations in photo-tone.....By John H. Guernsey, Government Postal Service	299
WHEN SORROW BECKONS AT THY DOOR—A Poem.....Howard Arnold Walter Now in the Orient	128
WILLIAM PYNCHON—An Immigrant to the New World in 1630—An Oxford Graduate who came to the Western Continent as an Indian Trader and settled on the trail —He accumulated wealth and founded a family which has contributed liberally to American Progress—Nathaniel Hawthorne's Controversy with the Pynchon family over his novel—Heirlooms of the early American pioneers—Described by Blanche Nichols Hill	509
WILL MAN HARNESS POWERS OF SUN, MOON AND TIDE?—Editorial writer in the "Baltimore Sun".....	577
WILL OF MARY WASHINGTON IN 1788—Mother of the first President of the United States—Transcribed from Clerk's office at Fredericksburg, Virginia By Mrs. Helen Cook Porter of Baltimore, Maryland	373

Americana Dubia—Mooted Questions in History

History is largely a matter of viewpoint. The man on the mountains and the man in the valley may gaze upon the passing panorama and both will see an entirely different picture. It has been the desire of these pages to allow observers to tell of events as they have seen them, without doubt or questioning, restricting only passions and prejudices. I recall James Anthony Froude, the eminent historian, in speaking of the varying viewpoints of history, once remarking that Tacitus and Thucydides were perhaps the ablest men who ever gave themselves to writing history, and also the most incapable of conscious falsehood; yet even now, after all these centuries, the truth of what they relate is called in question. "So at least it seems to me," added Froude, "wherever possible, let us not be told about this man or that. Let us hear the man himself speak, let us see him act, and let us be left to form our own opinions about him." This is just what has been done in these pages, "wherever possible." Many interesting discussions have developed, and in frequent instances the disputant has been introduced to the narrator and both have entered into a friendly search for the truth.

Strange as it may seem, the American Flag itself is a mooted question. Mrs. Champion's article on its evolution has taken her onto debatable ground. Charles C. Hall, of Berkeley, California, presents evidence that the Stars and Stripes were made from the military cloak of Captain Swartout, near Ticonderoga, and that the claims of Betsey Ross of Philadelphia, are at least open to comment. Mr. Hall's wife is a descendant of Captain Swartout.

D. M. Willers, of Fayette, Seneca County, New York, offers this suggestion: "Mrs. Champion, in speaking of naval battles of the War of 1812, says that not once was the flag of fifteen stars and fifteen stripes lowered in token of surrender. I wish to ask if there was not a flag on the Chesapeake when James Lawrence surrendered it to the British frigate 'Shannon,' in June, 1813. Was there no flag lowered when the American brig 'Argus' surrendered to the British sloop 'Pelican' in August, 1813?"

Mrs. William Dutcher, of 525 Manhattan Avenue, New York, adds the testimony that the Stars and Stripes were first proposed by General Israel Putnam, who was a cousin to her grandmother.

Honorable John H. Loomis, of the Board of Education of Chicago, in adding to Mrs. Champion's valuable information, calls attention to the fact that the war fund voted to President McKinley by Congress, of which she speaks, was fifty million dollars, and that the Puritans, whom she mentioned, were in Holland eleven years before coming to America.

Dr. G. Totten McMaster, a retired surgeon in the United States Navy, does not agree with Mrs. Champion on some of her investigations into the Spanish-American War. He denies any suggestion of credit to the army in the naval conflict off Santiago, and remarks that the "Oregon" did not fly the "homeward-bound flag" in her wonderful run around Cape Horn from the Pacific.

That grand old hero, Admiral W. S. Schley, of the United States Navy, who is now passing his well-earned rest in Washington, honored by the American people, in speaking of Mrs. Champion's article, gives this valued information from his own experiences: "There never was a balloon in the fleet before Santiago in 1898. There may have been land balloons in the army. Cervera's fleet was discovered by my ship on the morning of May 28th, 1898, and it was so reported to Washington on the following day, May 29th. The church pennant was not hoisted on the 'New York' on July 3rd, as that cruiser was at Siboney, eleven miles east of Santiago, at 9:35 on that morning when Cervera's fleet came out of Santiago harbor. The natural inference from Mrs. Champion's mention of the church pennant would be that the 'New York' was present in the fight that day, which is historically untrue. I do not care for myself, but I think it is a wrong to the officers and men of my flagship, the cruiser 'Brooklyn,' who did such sterling service to our country on that July day. As she was an important factor in the great events of that great day, I claim for her officers and men that credit which the Government acknowledged in advancing a number of them for 'conspicuous conduct in battle.' It is not my purpose to enter into any controversy over the honors of that day, but I must insist that history cannot omit the 'Brooklyn's' conspicuous part in the great naval engagement of that splendid July day in 1898 when the flag of Spain was driven forever from the waters of this Western Continent."

A controversy has arisen over the reminiscences of Judge Munson, who was sent by President Lincoln to sit on the bench of the first United States District Court within a thousand miles of the Rocky Mountains. This controversy is interesting as Judge Munson's judicial decisions were important factors in the moulding of law and order in Western America.

A well-known army officer, W. H. Keeling, of Falls City, Nebraska, says: "Being one of the first army officers to be stationed in Montana about the time of which Judge Munson writes, I am of the opinion that Colonel Reeve was not at Fort Rice in 1865. If my memory is right, he was thousands of miles away from there at that time. I do

Americana Dubia—Mooted Questions in History

not think that Malcolm Clark was a graduate of West Point. I remember talking with him about it and he said he was not. Neither do the records affirm that he was. His daughter has been superintendent of public instruction in Lewis and Clark County, Montana, and has been holding responsible positions under the direction of the Commissioner of Indian affairs. She might decide this matter."

Many venerable pioneers have offered their testimonies on several points, and each one of them differs in detail. Pioneers whom Judge Munson has not seen for fifty years have written to him recalling their acquaintance with him. Many of them corroborate his anecdotes, and an occasional one differs with him. E. Marshall of Manchester, Tennessee, who helped to blaze the trail for civilization in the Great West, does not believe that the Sioux Indians ever used poisoned arrows. He says:

"I was at the site of Ft. Rice from which he writes, before Ft. Rice was located in July, 1864, and again about the time when Judge Munson was there in 1865. I was in the battle of Ta-ha-kuta in July, 1864, when General Alf Sully defeated the combined force of the whole Sioux nation and made the route to Montana safe for more than ten years. I carry the scars of arrow wounds received there and have seen many arrow wounds both before and since that time. I have been intimate for years with men who had lived amongst these Indians and spoke their language fluently, and I never have seen or heard anything which made me suppose for a moment that poisoned arrows were in use, nor have I ever heard any person whom I believed was familiar with the facts, assert that such arrows were in use. Judge Munson saw an arrow which was alleged to have killed a man who died in great pain; well, arrow wounds are painful and many men have been killed by them but not by poison. The Sioux was treacherous, bloodthirsty and dangerous. The truth will paint him in sufficiently repulsive colors without the exaggeration of poisoned arrows."

The Fulton centenary and the story of the development of American commerce through steam as the power of propulsion, has brought out several claimants. The Fitch patriots question the justice of the recent centennial tributes to Fulton. To protect the accuracy of historical statement, several of these letters, that bear directly upon the truth, are here recorded. That esteemed man of letters, Frank H. Vizetelly, whose criticisms are always helpful, does not concede to the "Savannah" the honor of being the first to cross the Atlantic ocean. He says: "Inasmuch as this vessel sailed from Savannah May 22,

1819, on her voyage across the Atlantic, and that in the year 1818, a British steamship, the 'Rising Sun,' built by Lord Cochrane, crossed the Atlantic, it is evident that the 'Savannah' was not the first steamship to cross, and the 'British Queen' was not the first vessel built for trans-oceanic service in Great Britain. If you will consult Haydn's 'Dictionary of Dates,' page 647, you will find authority for this statement."

Through decades of eminent service to American letters, "The Century" is one of the most respected American institutions. It is an authority on all that pertains to America. William W. Ellsworth, who has been one of the strong factors in the building of "The Century," in speaking of President Tucker's article on the "Tercentenary of the First Permanent English Settlement in America," calls attention to the old English play, "Westward Hoe" as being written by Webster and Dekker in 1607, that it may not be confounded with "Eastward Hoe," written by Jonson, Chapman and Marston. In speaking of Simon de Passe's portrait of Pocahontas, and the statement that there is another portrait representing Pocahontas in native costume, seated, with her only child standing at her side, Mr. Ellsworth gives this information: "I have a photograph of it. It shows a conventional Indian squaw with a child of at least four years of age standing by her side, and as Pocahontas died when her baby was not two years old, it could not have been painted from life. Moreover, the member of the Rolfe family, living in Heacham Hall, who sent me the photograph, wrote that no claim was made by the family that it was a portrait of Pocahontas, but was simply a picture of an Indian woman wearing such ear-rings as she wore, and had been bought about twenty years before (this was five years ago). The child of Rolfe and Pocahontas was named Thomas and not John. I have often wondered why the inscription under this portrait calls John Rolfe 'Thomas,' and the same name occurs on the tablet at Gravesend. Last names may be spelled many different ways, 'Rolf,' 'Wroth,' etc., but there is no question of spelling over Thomas and John. I dare say the matter could be explained and perhaps it has been."

In the making of an historical magazine, there is a multitude of opportunities for the types to defeat an author's intention. While this is a common heritage of the printer's art, the absolute accuracy which this publication requires, leads it to call attention to instances where the truth of a statement is injured. This is especially so in the first number, on page 36, where Mr. Bullock intended to speak of Northampton County, Pennsylvania.

THE LAST LEAF

The key of Yesterday
I threw away,
And now, too late,
Before tomorrow's close-
locked gate

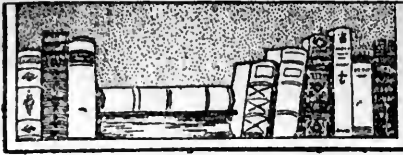

Helpless I stand—in vain
to pray!
In vain to sorrow!
Only the key of yesterday
Unlocks tomorrow!

EDITORIAL COMMENT

This last leaf in this last book of the year leaves us at the end of the first journey along the road of American civilization, and into the by-paths of our national life. The journey has been one of ever-increasing pleasures and the fellow-travelers that we have met along the way have strengthened our faith in the patriot-heart of America. A good doctor of letters early sent us this eulogium: "As Carlyle said of Schiller, you may pass your pages in the contemplation of ideal grandeur; you may 'live among the glories and solemnities of universal Nature; your 'thoughts may be of sages and heroes,' but 'you will find no rest, no peace,' for they are only ghosts." To this kind litterateur I recall at this time the further words of Carlyle: "Foolish Doctor! Did he ever, with the mind's eye, as well as the body's, look round him into that full tide of human life he so loved? The good doctor is a ghost, as actual and as authentic as heart could wish; sweep away the illusions of Time; compress the three-score years into three minutes," and we are all ghosts. "What else is he? What else are we? We start out of nothingness, take figure and are apparitions; round us as round the veriest specter, is Eternity;— and to Eternity minutes are as years and aeons. . . . Ghosts!"

The American People have much for which to feel proud, and little to regret, in the Book of Life that they have written and are writing. It is frequent for those who are now making History to denounce the age in which they are working. Mankind has always done so. I read a few days ago in an American newspaper: "It requires more energy for a man to succeed to-day than it required twenty years ago; more talent, more capital of brains and faculty; the competition is keener, the race is swifter, the life is faster. Hence the list of sacrifices to the Moloch of overwork." It is the plaint that has come down from the beginning. Baltasar Gracian, a learned Spaniard, far back in 1637, wrote: "Everything is at its acme, especially the art of making one's way in the world. There is more required nowadays to make a single wise man than formerly to make Seven Sages, and more is needed nowadays to deal with a single person than was required to deal with a whole people in former times." The truth is that the world, in its wonderful plan of evolution, is growing better all the time. The Infinite Idea knows no retrogression. It is always upward, onward. The pages of History are illumined by this truth. History is always Optimistic. It is the only true support man finds in the long journey.

My learned friends believe that History is the story of Ghosts! It is! Just as that master analyst, Carlyle, said that you and I are now but moving specters. "This stormy Force, this Life-blood with its burning passion—they are all but dust and shadow. That warrior on his strong war-horse: fire flashes through his eyes; Force dwells in his arm and heart; but warrior and war-horse are a Vision—a revealed Force—nothing more. Stately they tread the Earth as if it were a firm substance. Fool! the Earth is but a film; it cracks in twain, and warrior and war-horse sink beyond plummet's sounding. A little while ago we were not; a little while and we are not. So it has been from the beginning; so it will be to the end. Generation after generation takes to itself the form of a body. . . . What Force and Fire is in each he expends; one grinding in the mill of industry; one, hunter-like, climbing the Alpine heights of science; one madly dashing in pieces on the rocks of strife, in war with his fellow. . . . There are now a thousand million walking the earth openly at noontide; some half hundred have vanished from it, some half hundred have risen in it, ere thy watch ticks once," and every one of them is making History, which, according to its influence on the Great Whole, is narrative for these pages—this record of man's work.

History may be the story of ghosts! But it is not a "ghost story." It is a stern reality. It is all there is of man that lives to inhabit this great world more than a short span of years. You pass; I pass; even the towering structures that you may erect must crumble and fall. A flash of Time and there will be nothing left but the story of it all—and that story is History. "Like a God-created, fire-breathing Spirit-host, we emerge from the inane. Earth's mountains are leveled and her seas filled up in our passage. On the hardest adamant some imprint of us is stamped in; the last rear of the Host will read traces of the earliest Van." These are the footprints that are now being followed in these pages. Show me a man who says that he does not like History and I will show you a man whose character is doubtful; a man who is trying to take all he can out of life and has no intention of leaving anything worth while in it; a man who dislikes the written leaves of men because he knows that his own life story will pollute them. There is a moral force in History that holds men to their deeds and it is as relentless as it is eternal—there is no escape from it. Every man is inscribing his own leaf in the great volume of mankind. You will remember why good old Abou Ben Adhem's name "led all the rest."

580.

X





E
171
J86
v.1

The Journal of American
history

PLEASE DO NOT REMOVE
CARDS OR SLIPS FROM THIS POCKET

UNIVERSITY OF TORONTO LIBRARY

